

TOOLS THAT MAKE THEIR MARK.



# HOT DEALS

2023



Follow us!



€ HOT23-1/EN/XX/1

**EINFACH VIGOR.**

Recommended retail prices (RRPs) excl. VAT.  
Prices valid from 1 March 2023 until 31 August 2023 at the latest.  
Prices are subject to change before 31 August 2023. Errors excepted.

# XD power



## The space saver!

## EXTRA DEEP!



» With stainless steel worktop

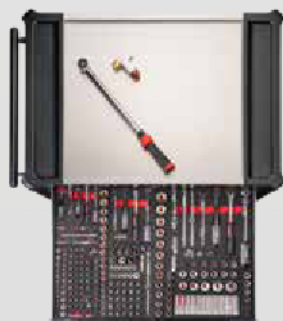

L x W x H  
986 x 695 x 1017 mm

» Drawer slide-out **100%**



**New design!**

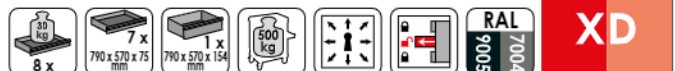

VIGOR No.	Designation	kg	EAN	€
V4481-XD	Tool trolley without assortment	114	4047728+ 066488	1,519.50



# Select your assortment for the trolley!

**V4481-XD/469**

EAN 4047728068512

**ASSORTMENT 1**

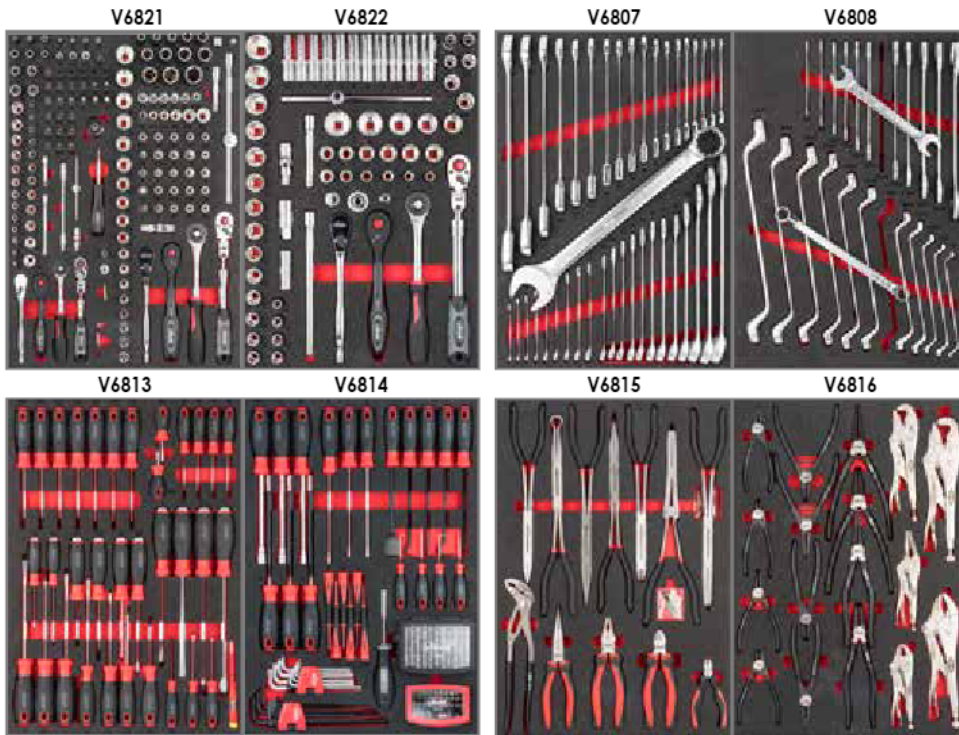

# 469

tools including  
tool trolley

+469  
**3,362.50 €**  
excl. VAT  
Price including tool trolley

**V4481-XD/775**

EAN 4047728068529

**ASSORTMENT 2**

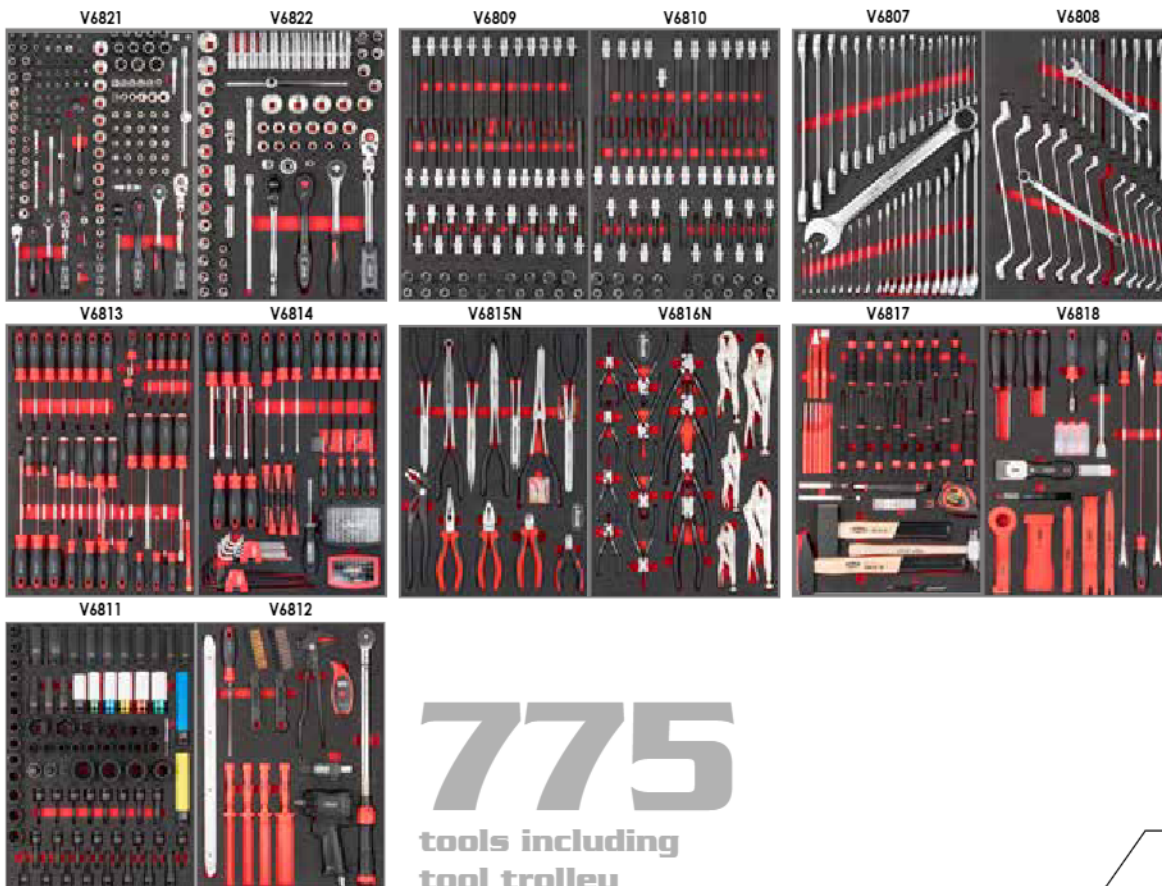

# 775

tools including  
tool trolley

+775  
**5,377.50 €**  
excl. VAT  
Price including tool trolley



With stainless steel worktop

**New design!**



L x W x H  
1017 x 940 x 514 mm

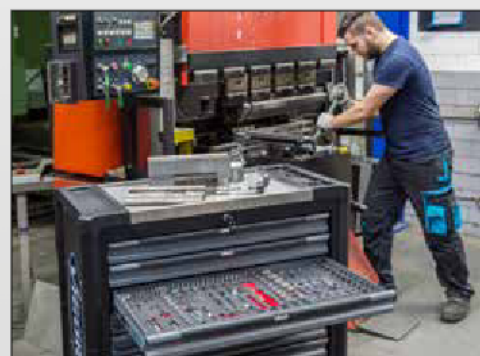

## Select your assortment for the trolley!

**V4481-X/375**

EAN 4047728062350

**ASSORTMENT 1**

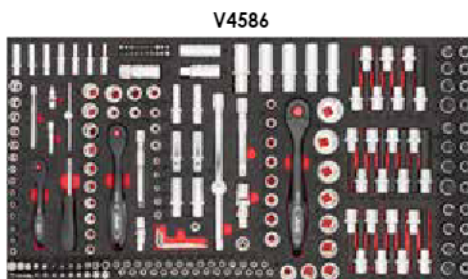

**375**  
tools including  
tool trolley

**+375**  
**2,444.- €**  
excl. VAT  
Price including tool trolley



- 8 x
- 753 x 398 x 75 mm
- 753 x 398 x 75 mm
- 500 kg
- 
- 
- 
- 

VIGOR No.	Designation	kg	EAN	€
V4481-X	Tool trolley without assortment	84	4047728+ 060721	1,490.50



V4481-X/466

EAN 4047728074674

**ASSORTMENT 2**

V4586

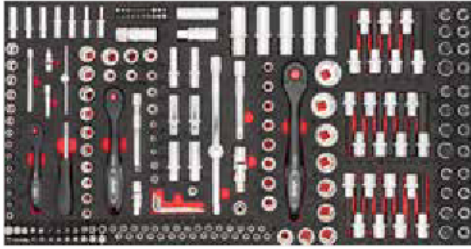

V6650



V7015N



V6015



V5170



Including accessories

**466**

tools including  
tool trolley

+466  
**2,749.- €**  
excl. VAT  
Price including tool trolley

V4481-X/499

EAN 4047728062367

**ASSORTMENT 3**

V4971

V4973

V4975

V7323



V4727

V5602

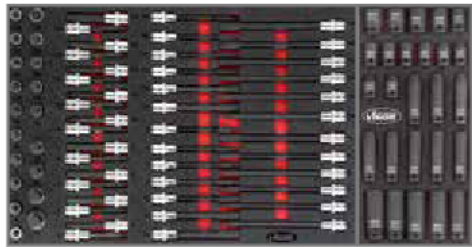

V5006

V5017

V5070

V5072



V6721

V6723

V4987

V6722



V5170



V4729

V5075



V5633N

V4995

V4999N

V5004



**499**

tools including  
tool trolley

+499  
**3,177.50 €**  
excl. VAT  
Price including tool trolley



With plastic worktop

**VIGOR**  
SERIES **XL**

New  
design!

8 x 753 x 398 x 75 mm 753 x 398 x 154 mm 500 kg RAL 7004 9005 **XL**

L x W x H  
919 x 481 x 1002 mm

## Select your assortment for the trolley!

**V4542**

EAN 4047728045421

**ASSORTMENT 1**

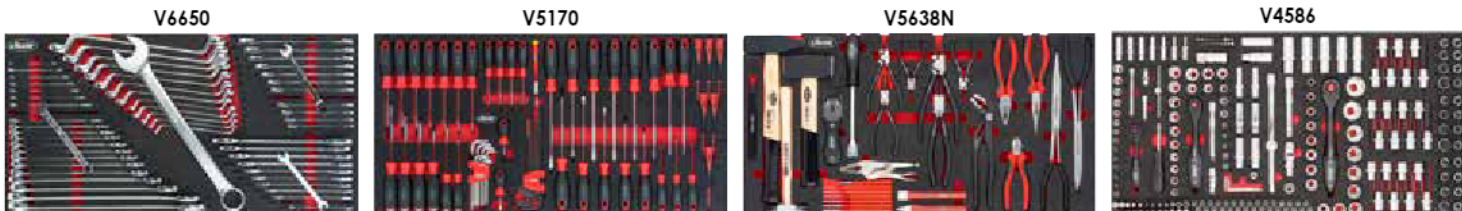

**375** tools including  
tool trolley

+375 **2,321.50 €**  
excl. VAT  
Price including tool trolley

**V5434**

EAN 4047728054348

**ASSORTMENT 2**



**499** tools including  
tool trolley

+499 **3,055.- €**  
excl. VAT  
Price including tool trolley



V1901/376

EAN 4047728080293

VIGOR SERIES L

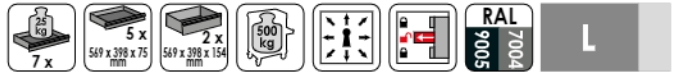

With plastic worktop

New design!

New



②

L x W x H  
733 x 481 x 1002 mm

V4188

V4753

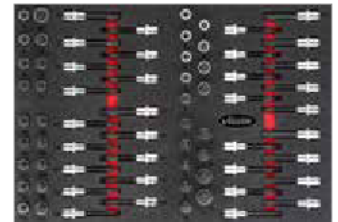
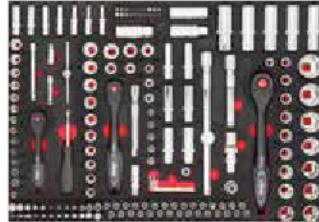

V6724

V5068

V5070

V5006

V5633N

V5603

V7324

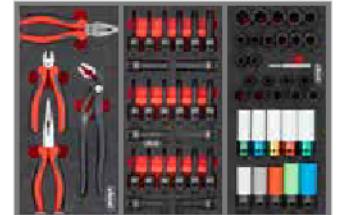

376 tools including tool trolley

+376

1,990.- €

Price including tool trolley

V4560

EAN 4047728045605

VIGOR SERIES L



With plastic worktop

New design!



②

L x W x H  
733 x 481 x 1002 mm

V4188

V6726

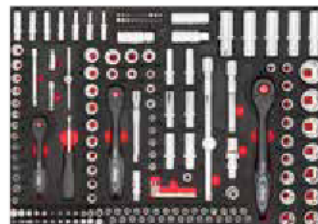

V4230

V5637N

V2837

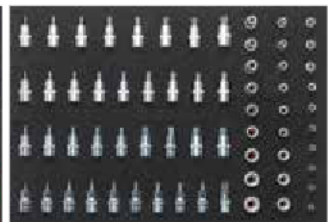
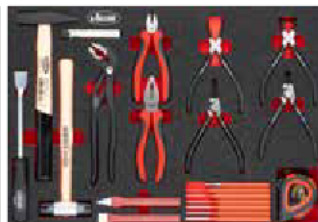
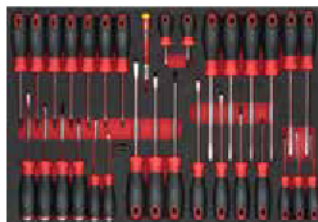

344 tools including tool trolley

+344

1,833.- €

Price including tool trolley

**V2712N**

EAN 4047728055451

**VIGOR SERIES M**

**With mat**
**New design!**

 L x W x H  
681 x 460 x 1016 mm

③

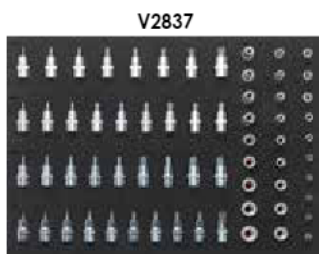
**V2837**

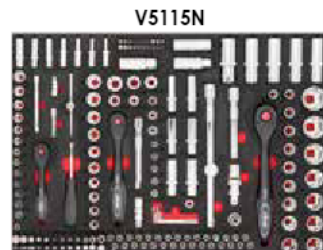
**V5111N**

**V5115N**

**V6726**

## 228 tools including tool trolley

+228

**953.- €**  
excl. VAT

Price including tool trolley

**V6689**

EAN 4047728079419

**Handle rail for tool trolley and VSS lower cabinets**

- Replacement handle rail with Vigor logo
- Suitable for all Series L, Series XL and Series XD tool trolleys as well as all VSS base cabinets

**5.90 €**  
excl. VAT

**V5603**

EAN 4047728078917

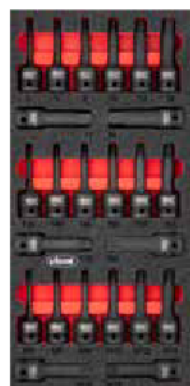
**Soft foam insert with impact screwdriver socket set**

**8 x 1/4" ♂**  
Sizes: 5 · 6 · 8 · 10 · 12 · 14 · 17 · 19 mm

**8 x 1/4" ♂**  
M5 · M6 · M8 · M10 · M12 · M14 · M16 · M18

**8 x 1/4" ♂**  
T30 · T40 · T45 · T50 · T55 · T60 · T70 · T80

24

**199.- €**  
excl. VAT

**V7324**

EAN 4047728080262

**Soft foam insert with impact screwdriver socket set**

**13 x 1/4" ♂**  
Sizes: 10 · 11 · 12 · 13 · 14 · 15 · 16 · 17 · 18 · 19 · 21 · 22 · 24 mm

**9 x 1/4" ♂**  
Sizes: 10 · 11 · 12 · 13 · 14 · 15 · 16 · 17 · 19 mm

**New**

Fig. see V6312/10 on page 26

**8 x ♂**  
Sizes: 15 · 17 · 18.5 · 19 · 19.5 · 21 · 22 · 22.2 mm  
1 x ♂ 17 mm  
1 x ♂ 21 mm

32

**249.- €**  
excl. VAT

## Tool trolley without assortment



	VIGOR No.	Series	kg	EAN 4047728+	€
①	V4481	<b>VIGOR SERIES XL</b>	93	044813	1,349.50
②	V1901	<b>VIGOR SERIES L</b>	72	019019	1,122.-
③	V5489	<b>VIGOR SERIES M</b>	61	054898	746.-



# VSS

VIGOR STORAGE SYSTEM



Take a look at our VSS brochure. This will give you more information about VSS!



## OUR STARTER KIT

### Storage system

- 3-module combination in wide design
- Available with wooden or stainless steel worktop
- Including side veneer



Feet adjustable in height to 50 mm

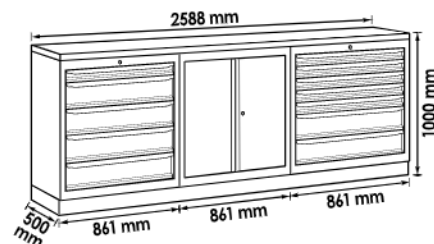

VIGOR No.	Designation	EAN 4047728+	€
<b>V6000-3P1XL</b>	Storage system combination · starter kit · wooden	<b>073318</b>	<b>2,499.-</b>
<b>V6000-3P1XL-X</b>	Storage system combination · starter kit · stainless steel	<b>073271</b>	<b>2,699.-</b>

## OUR COMPLETE KIT

### Storage system

- 3-module combination in wide design with perforated panel structure and wall cabinets
- Available with wooden or stainless steel worktop
- Including side veneer



Feet adjustable in height to 50 mm

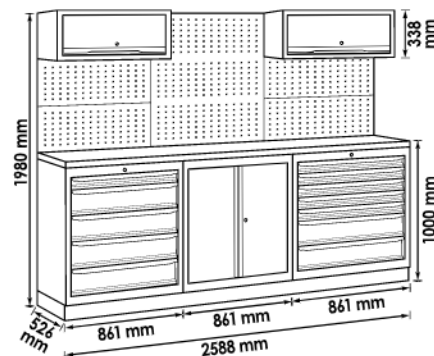

VIGOR No.	Designation	EAN 4047728+	€
<b>V6000-3P2XL</b>	Storage system combination · complete kit · wooden	<b>073301</b>	<b>3,299.-</b>
<b>V6000-3P2XL-X</b>	Storage system combination · complete kit · stainless steel	<b>073295</b>	<b>3,499.-</b>



# OUR COMPACT KIT

## Storage system

- Cabinet door can be fitted on the right and left
- Cabinet door with magnetic lock
- Height-adjustable storage compartment
- All doors reinforced in the centre
- Simultaneous locking (equivalent to the Series L locking system)
- Drawer dimensions same as for Series L (569 x 398 x 75 mm flat drawer, 569 x 398 x 154 mm high drawer)
- Wall cabinets including high-quality shock absorbers
- Perforated tool panel for VIGOR tool hook sets V2517 · V2518 · V2519 · V2520

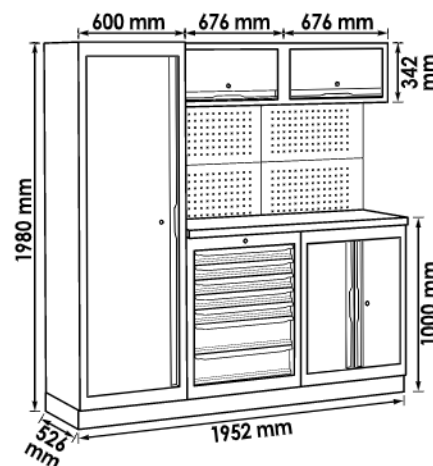
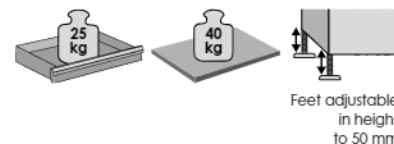

VIGOR No.	Designation	EAN 4047728+	€
<b>V6000-3</b>	Storage system combination · compact kit · wooden	<b>048729</b>	<b>2,699.-</b>
<b>V6000-3-X</b>	Storage system combination · compact kit · stainless steel	<b>073288</b>	<b>2,749.-</b>

Whether on your tablet, laptop or computer.  
**Start configuring now!**

[www.vigor-equipment.com/konfigurator](http://www.vigor-equipment.com/konfigurator)

- **2 modes:** linear or angular
- **Wood and stainless steel worktops:** 500 or 700 mm working depth
- **Installation aid:** for perforated tool panel plates and worktops
- **Forwarding of configuration:** sending to multiple email addresses is possible
- **Dimensional drawing**
- **Graphic illustration of the configuration**
- **Naming the configuration**
- **Materials overview and price list**
- **Assembly service**
- **Dealer search**



**V7600**

EAN 4047728079440

**Bit holder with articulated joint**

- 20° angular movement
- Bit holder can be locked in position
- For manual operation, electric screwdrivers and drills

6.3 1/4" 6.3 1/4"

**New**

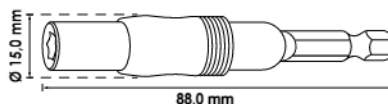
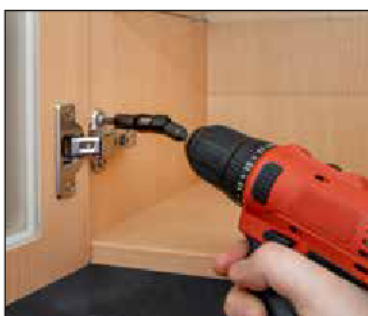
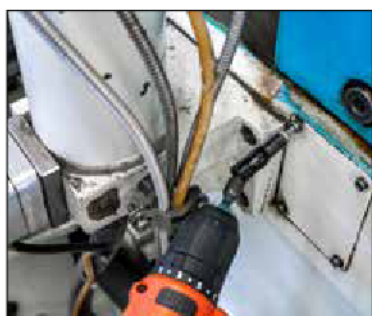
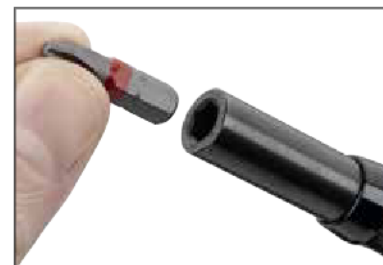

**11.50 €**  
EXCL. VAT

**BIT HOLDER WITH MAGNETIC RING • LONG**

- Strong magnetic ring to secure screws
- Bit can be recessed into the holder to create a contact surface for the screw head
- Ideal for hard-to-reach places
- For manual operation, electric screwdrivers and drills

6.3 1/4" 6.3 1/4"

**New**

*Available in two lengths!*

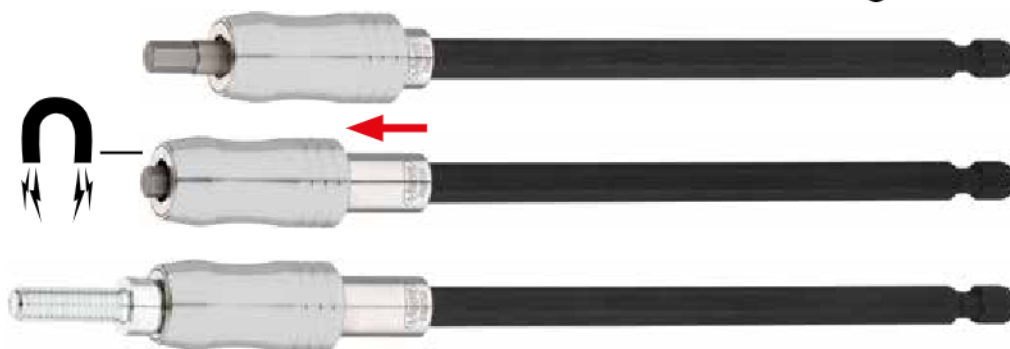

VIGOR No.	l mm	Ø mm	EAN 4047728+	€
<b>V7601-150</b>	150	15,5	<b>079433</b>	<b>9.90</b>
<b>V7601-250</b>	250	15,5	<b>079426</b>	<b>10.90</b>



# SOCKET ADAPTER WITH ARTICULATED JOINT

- 20° angular movement
- Socket adapter can be locked in position
- For manual operation, electric screwdrivers and drills

6.3 1/4"

**New**

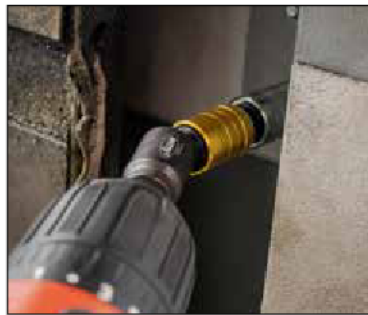

VIGOR No.	■	l mm	∅ mm	EAN 4047728+	€
V7614	6.3 1/4"	90	16	079457	11.50
V7638	10 3/8"	92	16	079464	11.90

**V7603/3**

EAN 4047728079471

## Socket adapter set

- For manual operation, electric screwdrivers and drills

6.3 1/4"

**New**

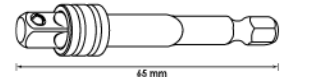
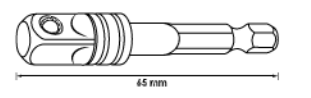
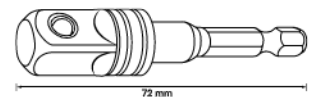
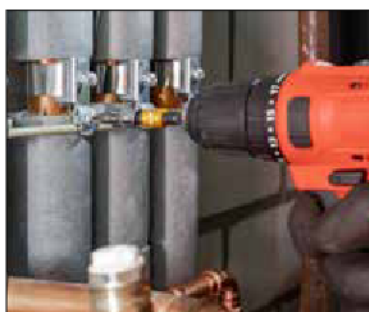

3

**9.90 €**  
excl. VAT

**V7920**

EAN 4047728077781

## T-plus socket set

- T-plus profiles are installed in the following engines (among others) **BMW · VAG · MERCEDES-BENZ · AUDI · MAN · FORD · OPEL · MAZDA · TOYOTA · NISSAN · RENAULT · SUBARU · GM**
- EP: Gearbox · clutch and flywheel
- IP: Wheel bearing · engine · gearbox · cam adjuster · flywheel · timing belt housing
- IPR: Engine · control unit · generators · side mirrors · plug-in pumps · air flow meters



Set contains all  
**T-Plus profiles**



T-profile



T-plus profile



Size	Profile	Applications
6.3 1/4	T-profile	T9 · T10 · T15 · T20 · T25 · T27 · T30
12.9 1/2		T40 · T45 · T50 · T55 · T60 · T70
6.3 1/4	T-plus profile	E4 · E5 · E6 · E7 · E8
10 3/8		E10 · E12 · E14 · E16
12.9 1/2		E18 · E20 · E22 · E24
6.3 1/4	T-profile	T9H · T10H · T15H · T20H · T25H · T27H · T30H
12.9 1/2		T40H · T45H · T50H · T55H · T60H
6.3 1/4	T-plus profile	T8IPR · T10IPR · T15IPR · T20IPR · T25IPR · T27IPR · T30IPR
12.9 1/2		T40IPR · T45IPR · T50IPR · T55IPR · T60IPR
6.3 1/4	T-profile	T8IP · T10IP · T15IP · T20IP · T25IP · T27IP · T30IP
12.9 1/2		T40IP · T45IP · T50IP · T55IP · T60IP
6.3 1/4	T-plus profile	EP4 · EP5 · EP6 · EP7 · EP8
10 3/8		EP10 · EP12 · EP14 · EP16
12.9 1/2		EP18 · EP20 · EP22 · EP24

75



**149.- €**  
excl. VAT

**V7784**

EAN 4047728077842

## Ratcheting wrench with screwdriver bit set

- Good accessibility for hard-to-reach places
- Bit assortment with 10 mm hexagon socket
- Bits are inserted into the ratchet, ratchet head height very low
- 2 sockets:
  - Rigid side for loosening tight screw connections
  - Bit ratchet socket with fine toothing of 72 teeth
- Length of ratcheting wrench: 250 mm

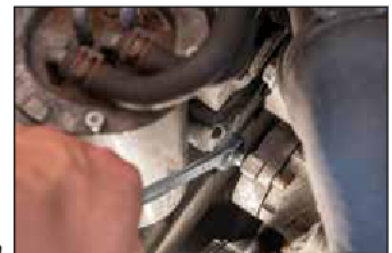
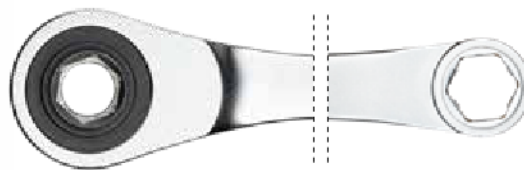

Screwdriver bit comparison

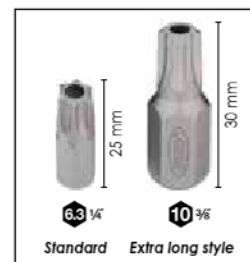

Size	Profile	Applications
10 3/8	T-profile	T10 · T15 · T20 · T25 · T27 · T30 · T40 · T45 · T50
10 3/8		T10H · T15H · T20H · T25H · T27H · T30H · T40H · T45H · T50H · T55H
10 3/8	T-plus profile	4 · 5 · 6 · 7 · 8 · 10 mm
10 3/8		M4 · M5 · M6 · M8 · M10 · M12
10 3/8		M5 · M6 · M7 · M8 · M10

36



**89.- €**  
excl. VAT



**V7917**

EAN 4047728075831

**T ball-head screwdriver socket set**

- For manual operation
- Angular movement 20°

125 1/2



32

99.- €  
EXCL. VAT

**Case contents:**

■		L mm	Size
125 1/2		55	T20 · T25 · T27 · T30 · T40 · T45 · T50 · T55
		75	T60 · T70
		100	T20 · T25 · T27 · T30 · T40 · T45 · T50 · T55 · T60 · T70
		140	T40 · T45 · T50 · T55 · T60 · T70
		200	T40 · T45 · T50 · T55 · T60 · T70

**V7919**

EAN 4047728075817

**Ball-head screwdriver socket set for inside hexagon screws**

- For manual operation
- Angular movement 20°

125 1/2



30

99.- €  
EXCL. VAT

**Case contents:**

■		L mm	Size mm
125 1/2		55	5 · 6 · 7 · 8 · 10 · 12 · 14
		75	17 · 19
		100	5 · 6 · 7 · 8 · 10 · 11 · 12 · 13
		140	5 · 6 · 7 · 8 · 10 · 12 · 14
		200	5 · 6 · 7 · 8 · 10 · 12

**V6412/4**

EAN 4047728079518

**Stud extractor set**

- For damage-free insertion and removal of studs and threaded pins
- Suitable for left and right-handed threads
- Outside hexagon 19 or 22 mm
- Sizes: 6, 8, 10 und 12 mm

125 1/2

**New**



4

29.90 €  
EXCL. VAT

**V5202**

EAN 4047728068987

### Socket set · super flat

- Flat insert profile – direct attachment to the nut/screw connection
- Robust solid steel reversible ratchet
- Through-hole sockets make it possible to work on stud bolts
- Sockets with outside hexagon size 11 mm for operation with box-end wrench or open-end wrench
- Drive: square 6.3 mm (1/4 inch)
- Output: outside hexagon profile
- Sizes: 4 – 14

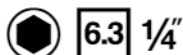

**V6202**

EAN 4047728062022

### Socket set · super flat

- Flat insert profile – direct attachment to the nut/screw connection
- Robust solid steel reversible ratchet
- Through-hole sockets make it possible to work on stud bolts
- Sockets with outside hexagon size 17 mm for operation with box-end wrench or open-end wrench
- Drive: square 10 mm (3/8 inch)
- Output: outside hexagon profile
- Sizes: 8 – 22

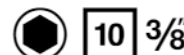

### Comparison

Standard size 17 mm

Super flat size 17 mm

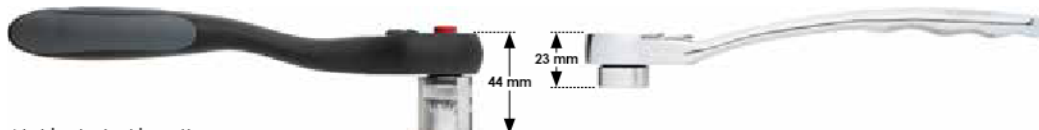

Not included in set!

25



79.-€

excl. VAT

18



119.-€

excl. VAT

**V7202**

EAN 4047728068888

### Socket set · super flat

- Flat insert profile – direct attachment to the nut/screw connection
- Robust solid steel reversible ratchet
- Through-hole sockets make it possible to work on stud bolts
- Sockets with outside hexagon size 22 mm for operation with box-end wrench or open-end wrench
- Drive: square 12.5 mm (1/2 inch)
- Output: outside hexagon profile
- Sizes: 8 – 32

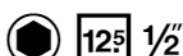

**V2318N**

EAN 4047728059299

### Socket set

- Drive: square 20 mm (3/4 inch)
- Output: outside hexagon profile
- Sizes: 19 – 50
- Number of teeth 24 (operating angle 15°)
- For manual operation

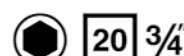

24



199.-€

excl. VAT

21



299.-€

excl. VAT



V5632

EAN 4047728080279

VDE tool set

- Compact and tidy tool case with all the tools needed to safely de-energise a vehicle
- Certified according to DIN EN 60900 up to 1,000 volts alternating voltage or 1,500 volts direct voltage
- For manual operation

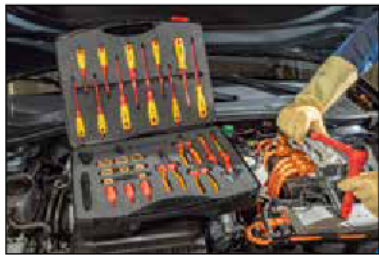

	■		Design	Size
9 x	125 1/2	●		8 · 10 · 12 · 13 · 14 · 17 · 19 · 22 · 24 mm
3 x	125 1/2	○		5 · 6 · 8 mm
1 x	125 1/2	125 1/2		Length: 125 mm
1 x	-	125 1/2		Length: 255 mm
4 x	-	●		0.5 x 3 · 0.8 x 4 · 1 x 5.5 · 1.2 x 6.5 mm
3 x	-	⊕		PH0 · PH1 · PH2
4 x	-	⊗		T15 · T20 · T25 · T30
1 x	-			Length: 160 mm
1 x	-			Length: 180 mm
1 x	-			Length: 200 mm
1 x	-			Length: 250 mm

29

499.- € excl. VAT

V4326N

EAN 4047728079860

Measuring cable set

- Motor vehicle applications and 12 V batteries
- Measuring line adapters for simplifying fault diagnostics directly on the vehicle
- Polarity testers for testing hall sensor and photo sensors
- Measuring potentiometer for testing the temperature sensor and tank sensor
- Use with multimeter V4324
- 3 flat terminals, flat terminal sleeves, round terminals, pin-type cable connectors and pin-type cable sleeves

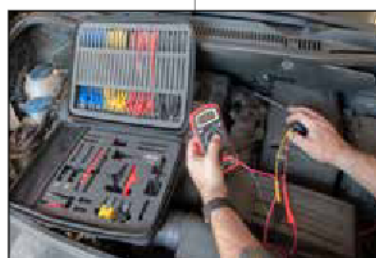

V4324

EAN 4047728043243

Digital multimeter

- DC: 200 mV – 600 V
- AC: 200 V – 600 V
- DC: 200 mA – 10 A
- Resistance: 200–2000 Ohm
- Diode tester
- Fuses:
  - 1 x 250 mA / 250 V
  - 1 x 10 A / 250 V
- Used with measuring cable set V4326N
- Functions:
  - Direct and alternating voltage measurements
  - Direct and alternating current measurement
  - Resistance measurement
  - Diode test (with acoustic signal)
  - Passage inspection (with acoustic signal)



92

199.- € excl. VAT

19.90 € excl. VAT

V7501/2

EAN 4047728080255

Ø 4.9 mm  
Probe

**Video borescope**

Analysis and documentation of damage patterns in difficult to access spaces!

**New**

- Probe: Ø 4.9 mm
- Probe length: 1000 mm
- Camera resolution: 1280 x 720
- Camera viewing angle: 80°
- 6 dimmable LEDs
- Depth of field: 20 – 80 mm
- 5" display, swivelling
- Display resolution: 1280 x 720 pixels
- 6 Ah, 3.7 V Li-ion rechargeable battery
- 2A/5V power supply unit, USB charging cable and 32 GB TF memory card included in delivery

Swivels 140° on both sides

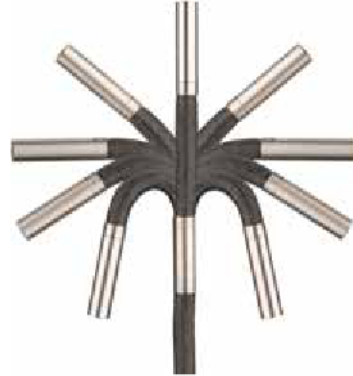

Screen can be moved freely in all directions



**1280 x 720 pixels**

4



**599.- €**  
excl. VAT

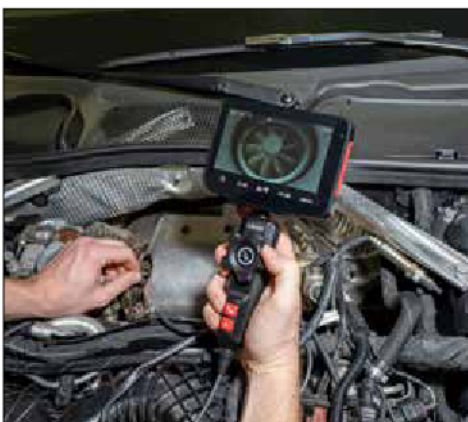



**V7500/2**

EAN 4047728076210

**Video borescope**

Analysis and documentation of damage patterns in difficult to access spaces!

- Probe: Ø 4.9 mm
- Probe length 1000 mm
- Camera resolution: 640 x 480 pixels
- Camera viewing angle 80°
- 8 dimmable LEDs
- Depth of field 20 to 50 mm
- 3.5" display
- Screen resolution: 320 x 240 pixels
- 2 Ah, 3.7 V Li-ion rechargeable battery
- 2A/5V power supply unit, USB charging cable and 8 GB TF memory card included in delivery



Ø **4.9** mm  
Probe

Swivels 140°  
on both sides

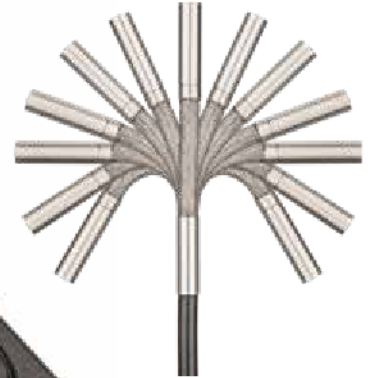

Included in delivery

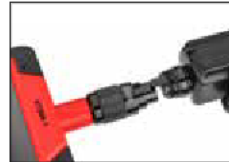

4 **399.- €** excl. VAT

**V7500-3.9**

EAN 4047728076227

**Probe Ø 3.9 mm · semi-flexible**

- Probe: Ø 3.9 mm
- Probe length 1000 mm
- Camera resolution: 320 x 240 pixels
- Camera viewing angle 90°
- 2 dimmable LEDs
- Depth of field 10 to 30 mm
- Side mirror, hook and magnet included in delivery



Ø **3.9** mm  
Probe



4 **213.- €** excl. VAT



**V5671N**

EAN 4047728076715

**MINI GIANT**

125 1/2 Impact wrench · mini



Size comparison between V5671N & V4800N

Ø mm	Nm	max. Nm	max. Nm	rpm	kg	l/min.	bar	m/s <sup>2</sup>
12,91 (H) 7,2	600	850	1200	10000	1.28	141.5	6.3	6.81

125 1/2

**1/2"**  
**1200 Nm**

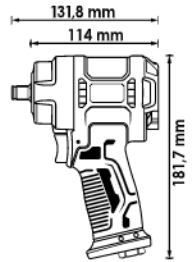

**99.- €**  
excl. VAT

**V4800N**

EAN 4047728075633

**ECO GIANT**

125 1/2 Impact wrench



Ø mm	Nm	max. Nm	max. Nm	rpm	kg	l/min.	bar	m/s <sup>2</sup>
12,91 (H) 7,2	850	1100	1720	7000	2.30	198.1	6.3	6.47

125 1/2

**1/2"**  
**1720 Nm**

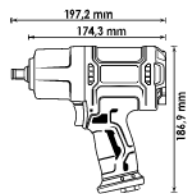

**79.- €**  
excl. VAT

**V6899N**

EAN 4047728076944

**GIGA GIANT**

20 3/4 Impact wrench



*The most powerful in its class!*

Ø mm	Nm	max. Nm	max. Nm	rpm	kg	l/min.	bar	m/s <sup>2</sup>
16,41 (H) 7,2	1400	2000	2300	5500	3.60	254.8	6.3	5.75

20 3/4

**3/4"**  
**2300 Nm**



**149.- €**  
excl. VAT

**V6907**

EAN 4047728075497

**Mini grease gun**

- Grease tube can be changed quickly due to the screw thread
- Feed rate: 0.45 ml / stroke
- Lubricating nipple in 30° and 90° designs
- M15 x 1.5 inside thread
- Grease tube not included in delivery



**12.90 €**  
excl. VAT

**V6907-1**

EAN 4047728075503

**High-performance grease**

- Replacement tube for V6907
- Provides corrosion protection due to good adhesion on metallic surfaces
- 100 ml filling capacity
- M15 x 1.5 outside thread



**4.90 €**  
excl. VAT



**V6740**

EAN 4047728077774

**Ignition coil puller VAG**

- Safe and damage-free removal of ignition coils with final output stage according to manufacturer's specifications, e.g. on 1.0 I / 1.0 I TSI / TFSI / TGI / GTI / CNG · 1.2 I TSI · 1.4 I-25/30/35/40/45 TSI / TFSI / TGI / CNG / GTE / Mild Hybrid / e-Hybrid · 1.6 I / 1.6 I SRE / MPI · 2.0 I GTI
- Engines installed in the following models, among others:
  - SEAT Alhambra, Arona, Ateca, Cupra Formentor, Ibiza, Leon, Mii, Tarraco, Toledo
  - ŠKODA Citigo, Fabia, Kamiq, Karoq, Kodiaq, Octavia, Rapid, Scala, Super, Yeti
  - VW Arteon, Beetle, Caddy, Golf 6-8, Jetta 4-7, CC, Passat B8, Polo 5-6, Scirocco, Sharan, T7, Taigo, Tiguan, Touran, T-Cross, T-Roc, Up
- Removal of both ignition coil versions possible:
  - 04C.905.110.J to 2017
  - 04E.905.110.K to 2017

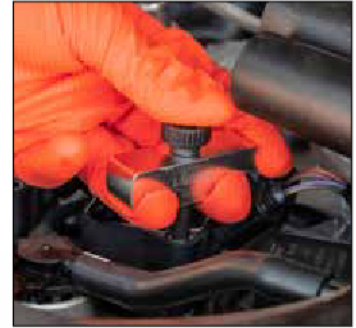

**29,90 €**  
excl. VAT

**V4941N**

EAN 4047728077293

**Injector sealing seat cleaning set**

- Eliminating soot residues, particles on HDi, diesel direct injection and common rail engines with Bosch and Delphi injectors
- Including sealing plug for protection against combustion chamber contamination
- Centring crowns for accurate guiding



» **Now with even greater market coverage!**

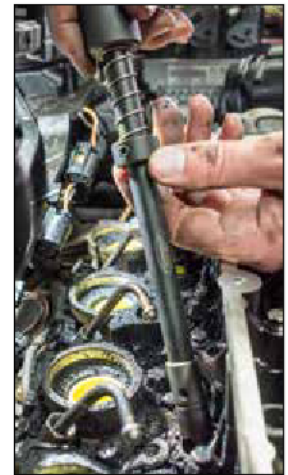

For components see catalogue page 267

27

**199.- €**  
excl. VAT

**V1963N**

EAN 4047728060097

**Cooling system diagnosis set**

- Comprehensive range of adapters, for vehicles with water-cooled engines
- 3 features: pressure test (check for leaks in radiator system), filling, cleaning
- Control of pressure loss via manometer
- Filling creates a vacuum in the radiator system (Advantage: coolant is sucked in without air bubbles)



For components see catalogue page 261

29

**349.- €**  
excl. VAT

**V4385N**

EAN 4047728072601

### Oil filling device with adapter set

- Filling gearboxes and differentials with oil
- Incl. oil pan and 16 adapters for vehicles with limited installation space



For components see catalogue page 273



18



**299.- €**  
excl. VAT

**V7385**

EAN 4047728077194

### MERCEDES-BENZ 9G-Tronic gearbox tool set

- Includes all necessary tools for changing the oil in the 9-speed Tronic automatic gearbox
- For draining and filling the gearbox oil
- For gearboxes with designation 725 (725589029000, 725589009000)
- Drain wrench for adjusting the standpipe
- Contents:
  - 1 x oil filter adapter
  - 1 x multifunction oil drain wrench
  - 1 x oil drain plug wrench



4



**29.90 €**  
excl. VAT

**V6027**

EAN 4047728060271

### Oil filling adapter set

- Uncomplicated filling of engine oil into the engine filler neck
- Adapter set made of durable aluminium
- Five different adapters for almost every vehicle
- No overflowing
- Plastic funnel with 1l capacity
- Angle extension enables simple filling of narrow areas

**As long as stock lasts!**



With B2 adapter for:  
VW Golf 7  
SEAT León (5F)  
SKODA Octavia 3 etc.

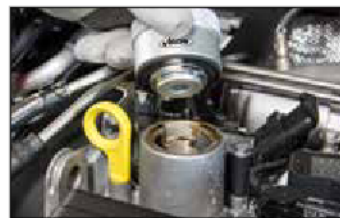

7



**199.- €**  
excl. VAT



**V4701**

EAN 4047728073844

**Mini vacuum pump**

- Manual vacuum pump for extracting and filling vehicle fluids
- Fill level display is nice and clear
- Accurate dosage and easy handling thanks to ergonomic design
- Capacity: 100 ml
- Including rubber tubing with stop cap to prevent leakage
- **For the following liquids:**
  - Diesel fuels
  - Petrol
  - Brake fluid
  - Antifreeze
  - Engine oil
  - Transmission oil
  - Power steering oil



**100 ml**

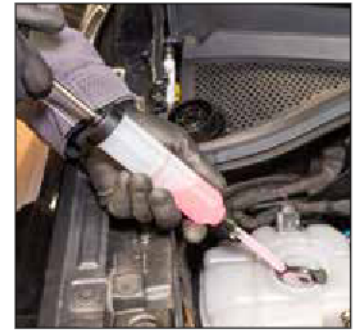

**16.90 €**  
excl. VAT

**V4369**

EAN 4047728043694

**Vacuum pump**

- Suction intake and decanting of fuels, oils and other liquids
- Capacity: 350 ml
- **For the following liquids among others:**
  - Diesel fuels
  - Petrol
  - Brake fluid
  - Antifreeze
  - Engine oil
  - Transmission oil
  - Power steering oil



**350 ml**

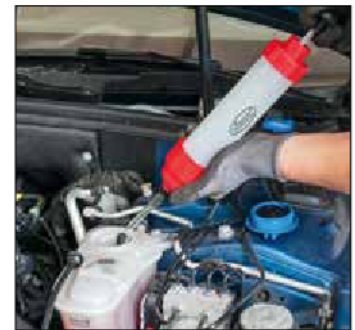

**34.90 €**  
excl. VAT

**V4201**

EAN 4047728042017

**Vacuum pump**

- Five adapters included
- Manual vacuum pump for extracting and filling vehicle fluids
- Pre-filling the fuel filter in vehicles without a pre-filter pump, e.g. the 2.0l TDI **FORD** Galaxy and Mondeo
- Capacity: 1.5 l
- **For the following liquids:**
  - Diesel fuels
  - Petrol
  - Brake fluid
  - Antifreeze
  - Engine oil
  - Transmission oil
  - Power steering oil



**1500 ml**



**55.- €**  
excl. VAT



**V7471/17**

EAN 4047728077187

## Brake bleeding complete set

For bleeding brake line systems and changing brake fluids

- Comfortable application thanks to ergonomic special ratchet
- Also for bleeding coupling systems
- Easy opening and closing of the brake nipple thanks to special hinge ratchet
- Guarantees fast access to the brake nipple even with the wheel mounted
- Good power transmission due to application-optimised handle
- Angle coupling piece in 90° design with back pressure valve and anti-rotation protection
- Back pressure valve protects system against ingress of air
- Socket inserts: size 7 – 12 mm in short and long designs included in delivery

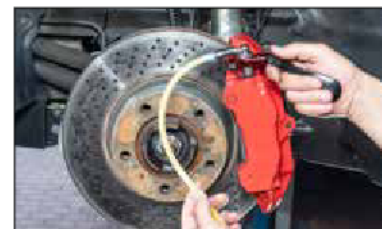

Take a look!

17

179.- €  
EXCL. VAT

**V7401**

EAN 4047728074018

## Brake disc thickness gauge · digital

- Measuring minimum thickness of brake discs
- Performing the measurement without wheel removal
- Digital LCD display
- Stainless steel design
- Note: note the minimum wear limits of the brake discs from the vehicle manufacturer manual
- Including 3 volt battery CR2032
- Measuring range from 0 – 80 mm
- Automatic switch-off function



85.- €  
EXCL. VAT

**V7120**

EAN 4047728077200

## Brake line holding tool

- Non-damaging grip on Ø 4.75 mm brake lines thanks to optimised clamping
- The brake line can be re-bent in the installed state to replicate the exact shape of the original
- Suitable for steel, copper-nickel and plastic-coated brake lines

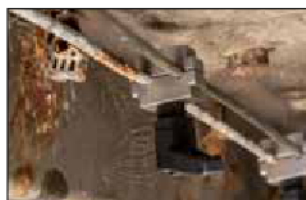

4

57.50 €  
EXCL. VAT

**V6917**

EAN 4047728069175

## Brake line ratcheting tube cutter Ø 4.75 mm

- Space saving, with ratchet mechanism
- Ratcheting mechanism in the head of the tool minimises space required – can be used directly on the vehicle
- No readjustment of the cutting wheel due to self-adjustment
- Faster cutting result than with conventional line cutters
- Adjustment of the self-adjusting cutting force possible
- Spare blades V6917-REP



34.90 €  
EXCL. VAT

**V4416**

EAN 4047728044165

## Tube flaring tool for Ø 4.75 mm brake lines

- Exclusively for DIN flaring
- Exact positioning of the brake line in the device using a spacing adapter
- Application on brake and hydraulic lines directly on the vehicle
- For thin-walled pipes made of steel, aluminium and copper (metric / inch)
- No damage to coated lines
- For DIN "F" flares 180°



49.90 €  
EXCL. VAT



**V1711N**

EAN 4047728060738

**Brake piston readjusting tool set · pneumatic**

- Pushing and turning of brake pistons on nearly all passenger cars
- Efficient work on brake systems
- For clockwise and anti-clockwise brake pistons
- In addition to pneumatic support, controlled rewinding by hand is also possible

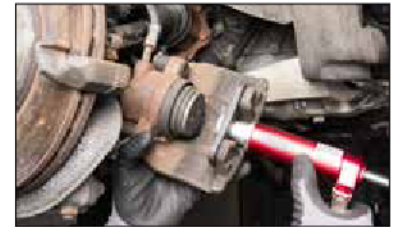

23



149.- €  
excl. VAT

**V7158**

EAN 4047728071581

**Brake calliper screw connection set**

- Brake calliper screw connection on e.g. VW · AUDI · PORSCHE · MERCEDES-BENZ · BMW · FORD · MAZDA and Volvo
- Including all common profile sizes for removal / installation of the brake calliper
- Special profiles for loosening the screw connections of separated brake callipers
- Ideal for floating and fixed brake callipers



12



69.- €  
excl. VAT

**V7259**

EAN 4047728072595

**Brake line bending tool**

- Bending device for easy duplication of brake pipes that keep their shape
- Especially for brake lines made of coated plastic, steel and copper-nickel
- Five different bending radii: 25 · 35 · 50 · 65 · 80 mm



29.90 €  
excl. VAT

**V7244**

EAN 4047728072441

**Brake line straightening tool Ø 4.75 mm**

- Easy straightening of Ø 4.75 mm lines
- Especially for brake lines made of steel or copper-nickel
- Effective method for straightening misshapen lines, especially for reels
- Simply sliding back and forth is sufficient as an application impulse
- Targeted straightening reduces the material costs
- Replaces conventional, imprecise shaping of wires



99.- €  
excl. VAT

**V6312/10**

EAN 4047728077804

### Impact socket set

- Damage-free operation of wheel bolts by rotating plastic sleeve
- Comprehensive set with all necessary nut-drivers
- For impact operation
- Size 15 · 17 · 18.5 · 19 · 19.5 · 21 · 22 · 22.2 mm



10



**95.- €**

excl. VAT



**V5933/3**

EAN 4047728079624

### Impact socket set, extra long

- Damage-free operation of wheel bolts by rotating plastic sleeve
- Extra long design
- For impact operation
- Size 17 · 19 · 21 mm

12<sup>5</sup>/<sub>16</sub> 1/2

**New**



VIGOR No.	□	mm	∅ mm	EAN 4047728+	€
V5930	12 <sup>5</sup> / <sub>16</sub>	150	26	059305	29.90
V5931	12 <sup>5</sup> / <sub>16</sub>	150	28	060318	29.90
V5932	12 <sup>5</sup> / <sub>16</sub>	150	30	079617	29.90

12<sup>5</sup>/<sub>16</sub> 1/2  
Size 17 mm

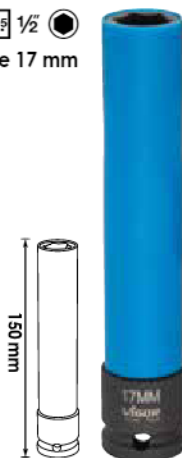

12<sup>5</sup>/<sub>16</sub> 1/2  
Size 19 mm

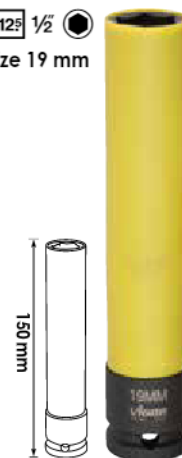

12<sup>5</sup>/<sub>16</sub> 1/2  
Size 21 mm

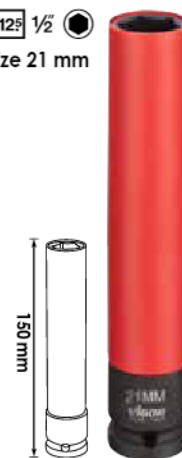

3



**69.- €**

excl. VAT



V7001

EAN 4047728075060

**Universal rim lock removal set**

- Malleable rim keys for loosening almost all rim locks
- Also for rim locks with clover leaf profile, among others
- Malleable rim keys adapt to the profile by hammer strike
- Rim keys can be used on both sides
- After forming a rim key, all four rim locks of a vehicle can be released
- Multiple deformation of a key side not possible
- Contents:
  - 8 rim keys
  - 2 adapters
  - Socket 1/2" - size 24 mm
  - Impact body
  - Centring pin
  - Hand guard trim



**Take a look!**



13 249.- €  
EXCL. VAT



V7001/4

EAN 4047728075336

**Rim key set**

- Key set with Ø 13 mm and 15 mm can be used on both sides
- Spare part for universal rim lock removal set V7001
- Material: AHSS (carbon steel)



4 39.90 €  
EXCL. VAT

**TORQUE WRENCHES**

- Torque release: palpable and audible
- Release accuracy tolerance ± 4% of the scale value (in direction of actuation)
- With serial number and certificate
- DIN EN ISO 6789-2:2017, DIN 3120, ISO 1174-1A

±4%

125 1/2"

72 45°



MADE IN GERMANY

VIGOR No.	Nm		mm	Tolerance %	EAN 4047728+	€
V3898	20 - 120	125 1/2"	445	4	038980	119.-
V3441	40 - 200	125 1/2"	540	4	034418	119.-
V3899	60 - 320	125 1/2"	610	4	038997	139.-

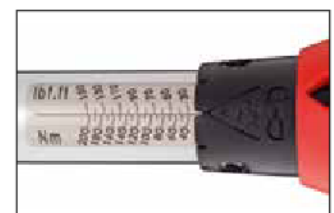
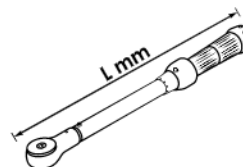

# NITRILE GLOVES

Protects hands from oil, grease, chemicals and dirt

- Surface structure provides good adhesion, even in oily working conditions
- Safety colour orange for better visibility in dark work spaces
- Comfortable, tear-resistant glove with good dexterity
- Touchscreen compatible
- Material: Nitrile
- Latex and powder free

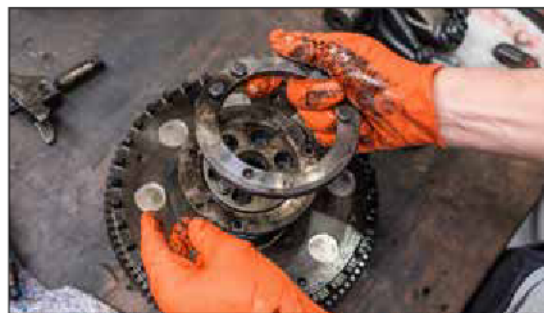

VIGOR No.		Size	EAN 4047728+	€
<b>V6436-M</b>	100 pcs./carton	M	<b>080118</b>	<b>32.-</b>
<b>V6436-L</b>	100 pcs./carton	L	<b>077712</b>	<b>32.-</b>
<b>V6436-XL</b>	90 pcs./carton	XL	<b>077729</b>	<b>32.-</b>
<b>V6436-XXL</b>	90 pcs./carton	XXL	<b>077736</b>	<b>32.-</b>

**New**

# WORKING GLOVES

## Working gloves

- Assembly work in the workshop, warehouse / logistics and anywhere where secure grip and precision are important
- Light polyester woven gloves with ergonomic fit
- EN 388:2003 (3131A)



**Black PU coating  
on the palms**

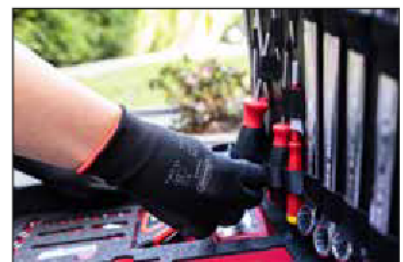

VIGOR No.	Size	EAN 4047728+	€
<b>V6435</b>	9 / L	<b>064354</b>	<b>1.60</b>
<b>V6435-XL</b>	10 / XL	<b>069984</b>	<b>1.60</b>



**V3551N**

EAN 4047728075084

**Repair set for plastic parts**

- Repair and reinforcement of plastic parts
- Extensive use and practical for household, workshop or handcraft
- Plastic parts such as containers, components of any kind or cladding can be repaired immediately
- 3-in-1 function with replaceable fixtures
- Power: 50 watts
- Maximum useful life: 35 minutes
- Charging time: 3.5 hours
- Contents:
  - 1 basic unit
  - 1 equipment stand
  - 1 charging cable
  - 50 repair staples type W /  $\varnothing$  0.6 mm
  - 50 repair staples type W /  $\varnothing$  0.8 mm
  - Welding rods: 5 x PE, 5 x PS, 5 x ABS, 10 x PP
  - 2 reinforced grids
  - 3 adapters

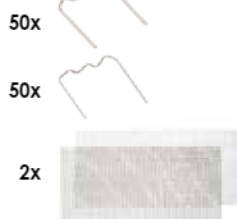
**Included in delivery:**

**For components  
see catalogue  
page 307**

133

199.- €  
excl. VAT**V4636N**

EAN 4047728078719

**Inner bearing extractor**

- For inner bearing rings that rest against the wheel hub
- For rings in the clamping range 33 – 60 mm
- Replaceable cones with  $\varnothing$  32 mm and  $\varnothing$  40 mm for extensive market coverage
- Also suitable for models with ABS cage, e.g. VW Golf IV
- Fixing screw prevents the arms from slipping off
- Operation with reversible ratchet

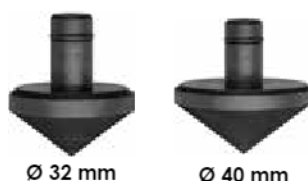
**Included in delivery:**

Ø 32 mm

Ø 40 mm

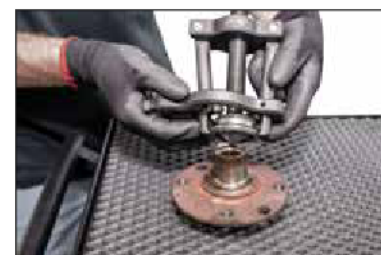

5

225.- €  
excl. VAT

**V4891**

EAN 4047728048910

**1.5  
kw**

**Induction heater · 1.5 kW**

- Modern and efficient heating – prevents damage to surrounding components
- Targeted heating within seconds
- Prevention of overheating with a simultaneously high degree of efficiency due to two fans
- Connecting cable: 3 m
- Reel hose length: 700 mm
- Controlled fan cooling
- Tube coils: heating pipes, bolts, profiles of various diameters
- Flexible coil: for loosening parts that are difficult to access due to the use of a special winding wire
- Flat coil: for heating the car body and sheet metal, makes it easier to remove stickers, sealants etc.
- 4.5 kg

» **Including  
4 coils**



For components  
see catalogue  
page 308

5 **749.-€**  
excl. VAT

**V4891/6**

EAN 4047728062206

**Induction coil expansion set**

- Set comprising:
  - V4891-5 (focus coil for spot heating)
  - V4891-6 (rigid coil)
  - V4891-7 (rigid coil)
  - V4891-8 (flexible coil, ceramic guard)
  - V4891-9 (rigid coil)
  - V4891-10 (rigid coil, lateral)
- Compatible with induction heater V4891 and V4891-1.0

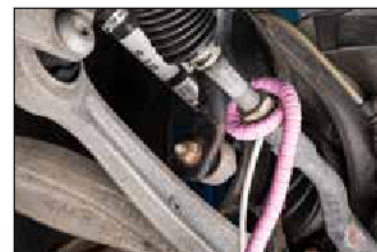

V4891-9

V4891-7

V4891-8

V4891-10

V4891-6

V4891-5



For components  
see catalogue  
page 309

6 **399.-€**  
excl. VAT



V4891-3.5

EAN 4047728072779

## Induction heater · 3.5 kW

- Modern and efficient heating – prevents damage to surrounding components
- Targeted heating within seconds
- Cooling fluid and focus coil included in delivery
- Water cooling up to the coil head
- Avoidance of overheating thanks to integrated ventilator
- Extensive accessories for various application fields
- Highest possible capacity in compact design
- Output power can be precisely adjusted for the application field – from 10 – 100 %
- Operating information via LED display on the handle



For components  
see catalogue  
page 311



2



2,499.- €

excl. VAT

V4891-10.0

EAN 4047728077958

## Induction heater · 10 kW

- Ultra-strong 10.0 kW variant for heating solid components
- Mobile unit with chassis and integrated water cooling system
- Quiet operation
- Efficient method of heating, without damaging surrounding components
- Risk minimisation compared to oxy-acetylene burners
- 10 litre-water cooled
- Compact unit in relation to the output power of 10.0 kW
- Output power can be precisely adjusted for the application field
- Stepless power control from 10 to 100 percent
- Delivery includes cooling fluid
- LED on the coil head indicates operation
- Precise heating in just a few seconds with cutting-edge microprocessor technology
- Power supply 3 x 400 V – 32A



2



6,999.- €

excl. VAT

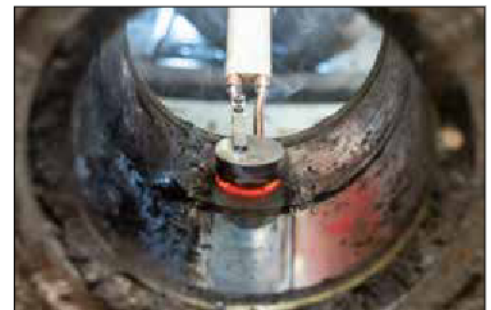

**New**

# Our new compact induction heater!



**V4891-1.0**

EAN 4047728080217

## Induction heater · 1.0 kW

- Compact induction heater for flameless heating of components and work pieces
- Risk minimisation compared to oxy-acetylene burners
- LED on the coil head indicates operation
- Compact unit in relation to the output power of 1.0 kW
- Precise heating in just a few seconds with cutting-edge microprocessor technology
- Power supply: 230 V
- Set comprising:
  - V4891-1 (rigid coil)
  - V4891-2 (flexible coil)
  - V4891-3 (rigid coil)
  - V4891-4 (flat coil)

# 1.0 kw

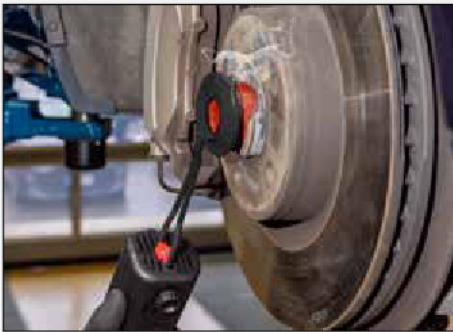

For components  
see catalogue  
page 308

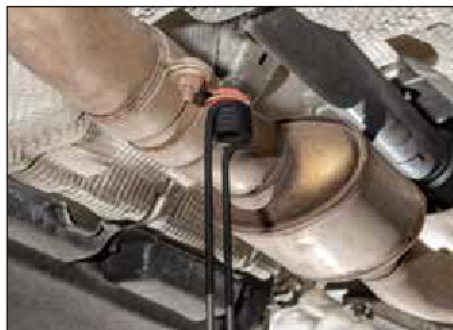
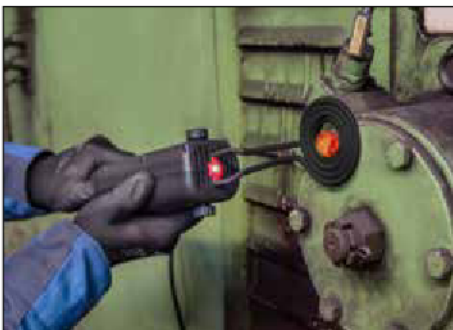

5

**499.- €**  
excl. VAT

Your VIGOR specialist dealer:

VIGOR GmbH · Am Langen Siepen 13-15 · 42857 Remscheid · GERMANY  
[www.vigor-equipment.com](http://www.vigor-equipment.com) · [info@vigor-equipment.com](mailto:info@vigor-equipment.com)

EINFACH VIGOR.

Recommended retail prices (RRPs) excl. VAT; during the promotion period, these prices replace all other RRP's



4 000896 1251858





**V5916**

EAN 4047728059817

**V5916-1**

EAN 4047728072953

### Ball joint ejector

- For the hydraulic removal of the ball joint pivots on steering tie rods as well as stabilisers with a maximum compressive force of 4.5 tonnes



### Pressing tool with bolt

- Extension for ball joint ejector V5916
- Pressing out ball joints and steering tie rod ends with bolts instead of nut threaded connections on the cone axis
- Pressing tool can be adapted and adjusted individually to the installation situation



4.5t



185.50 €  
EXCL. VAT

**V5916-2**

EAN 4047728073554

### Pressure foot extension

- Extension for ball joint ejector V5916
- For ball joint pins with a length over 72 mm
- Used in e.g. SUVs and commercial vehicles from CHEVROLET or GMC
- Set consisting of pressing tool and pressing piece
- Can be used in constricted spaces

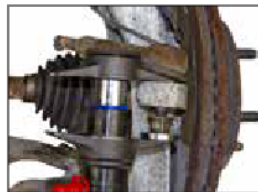

2

127.- €  
EXCL. VAT

**V5916-XL**

EAN 4047728066471

### Ball joint ejector

- For the hydraulic removal of the ball joint pivots on steering tie rods as well as stabilisers, or steering and brake lever for trucks and buses, with a maximum compressive force of 8.8 tonnes



8.8t



3

1,199.- €  
EXCL. VAT

**V4680**

EAN 4047728046800

## Compact wheel bearing removal and installation set

- Pump not included in delivery
- For removing and installing compact wheel bearings with or without circlip
- Use with hydraulic cylinder, mechanical spindle or workshop press
- Max. load: 22 t
- For e.g.:
  - VOLKSWAGEN: Polo, Lupo, Touareg, Fox, T5 front and rear, Crafter
  - AUDI: A2
  - SEAT: Ibiza, Córdoba
  - SKODA: Fabia, Rapid, Roomster
  - FORD: Focus, C-Max, Mondeo, S-Max, Kuga, etc.

Compact wheel bearing



## Basic set

15

1,199.- € excl. VAT



## Expansion set 1

V4680 with hydraulic foot pump and hydraulic cylinder



## Expansion set 2

V4680 with pneumatic foot pump and hydraulic cylinder

**V5554**

EAN 4047728055543

## Compact wheel bearing expansion set

- V4680 with hydraulic foot pump and hydraulic cylinder

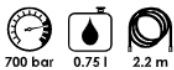

- Non-drip quick coupling
- For all hydraulic cylinders

V2847

**V5554-2**

EAN 4047728069021

## Compact wheel bearing expansion set

- V4680 with pneumatic foot pump and hydraulic cylinder

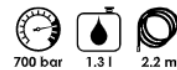

- Design with manometer
- Non-drip quick coupling
- For all hydraulic cylinders



V2846

Basic set



Hydraulic cylinder

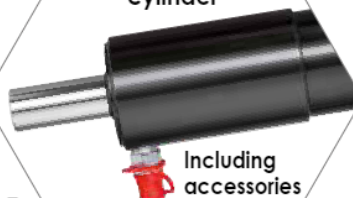

Including accessories

28

2,399.- € excl. VAT

28

2,599.- € excl. VAT



**V7859**

EAN 4047728078597



## Wheel bearing removal set · rear axle

- Efficient and safe separation of the wheel bearing from the semi-axle directly on the vehicle
- The hub axle is removed from the wheel bearing to the front with the help of the wheel hub puller
- Special support elements prevent damage to the brake heat shield

- For e.g.:
  - VOLKSWAGEN: Amarok from 2010 →
  - MITSUBISHI: L200 from 2006 →
  - TOYOTA: Hilux from 2005 →

**VW Amarok**  
**Mitsubishi L200**  
**Toyota Hilux**



14 1,250.- €  
excl. VAT

VIGOR No.	Designation	Design	EAN 4047728+	€
<b>V7860</b>	Support jaws set		<b>078603</b>	39.-
<b>V5905</b>	Wheel hub / wheel bearing puller		<b>059152</b>	430.-
<b>V5027</b>	Wheel hub puller		<b>050272</b>	245.-
<b>V5906</b>	Wheel bearing unit · screwed		<b>059183</b>	859.50



**V7071**

EAN 4047728078610

## VAG screw set

- For removing wheel bearings of generation 3 (screwed and split) on various VAG steering knuckles
- Original screw connections of the wheel bearings cannot be used for removal
- Screw set can only be used in combination with the wheel bearing puller V5903N

- Contents:
  - 4 x hexagon screw M12 x 1.5 x 60 mm

- For e.g.:
  - AUDI: A6, A7



4 39.- €  
excl. VAT



V7201

### Compact wheel bearing set for removal and installation

- For removing and installing compact wheel bearings with or without circlip
- Adjustability enables use on all types of currently available and future compact wheel bearings



Installation



Removal



V4906N

### Standard wheel bearing set for removal and installation

- New effective method for removing wheel hubs; the use of wheel bearing set V4598 is recommended here. The set also functions with steering knuckles with uneven and limited surfaces
- Allows the wheel bearings to be changed directly on the vehicle with minimum effort
- Mounting washers with a diameter of 62 – 83 mm and support discs of 34 – 60 mm are included; the bearing shell is suitable for wheel bearings of up to 92 mm in diameter



V5549-1N

### Expansion set for compact wheel bearings

- Set contains 4 expansions:
  1. Disassembly feet for compact wheel bearings screwed with 3 bolts
  2. Disassembly feet for compact wheel bearings screwed with 4 bolts
  3. Disassembly unit of the wheel hub without prior removal of the drive shaft
  4. Disassembly unit of the screwed wheel bearing without prior removal of the drive shaft
- Especially for expanding and completing compact wheel bearing sets
- When combined with the base unit V4680, all commercially available compact wheel bearings can be removed/installed



Screwed wheel bearing units – 3 bolts



Screwed wheel bearing units – 4 bolts



Extraction of the wheel hub without removing the drive shaft



Removal of the wheel bearing without removing the drive shaft



V7722

### Press frame expansion set

- Set contains:
  - 14 t compressive hydraulic cylinder including thrust rod M 24
  - Support set 275 mm
  - Open plate including screw M 16 x 40 mm



V7723

### Drawbar expansion set

- Universal expansion for 18 t and 22 t hydraulic cylinder
- Spindle set makes it possible to remove and insert even more bushings and bearings with various inside diameters
- Set contains:
  - Adapter: M 22 – M 10 · M 22 – M 12 · M 22 – M 14 · M 18 – M 22
  - 4 drawbars including flange nuts: M 10 x 1.5 · M 12 x 1.75 · M 14 x 2.0 · M 20 x 2.5
  - Striker nut M 18



V5741N

### Rear axle longitudinal control arm · silent block FORD, MAZDA, Volvo

- For changing the bushing of the front longitudinal strut in the rear area and for changing the rear axle bushings
- Do not load the bushing and press frame with more than 22 tonnes



V7030-2

EAN 4047728077323

Mobile work bench with specialty tool assortment

141

10,599.- €  
EXCL. VAT

### Pressure sleeve set

- Including 24 pressure pieces of different sizes
- Sleeves with small diameters are reversible
- Adapter and pressure shaft enable application of the press frame V2885—useful when removing or installing bushings and supporting joints without holes



» **UPDATE:**  
*now even more fields of application!*



V5066



V2846

- Design with manometer
- For all hydraulic cylinders
- Working pressure: 700 bar
- Hose length: 2.2 m
- Oil tank: 1.3 l

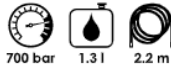

V6395

Incl. container for storing the pump.

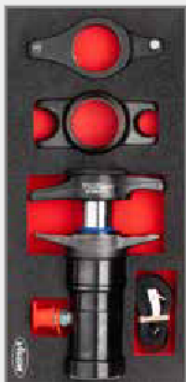

V7724

### Ball joint ejector

- Set for universal removal of ball joints with 4.5 t compressive force
- Contains hydraulic unit V5916 and expansions V5916-1 and V5916-2
- V5916-1: Pressing out ball joints as well as steering tie rod ends, with bolts instead of nut threaded connections on the cone axis
- V5916-2: For ball joint pins with a length over 72 mm



V5916

### Set of devices for the removal of drive shafts

- For passenger cars with T4 and 5-hole wheel hubs due to oval holes for wheel bolts
- Prevents heating of or damage to the drive shaft or damage to other parts



V4904







**V5168**

EAN 4047728051682



### Set of devices for the removal of drive shafts

- For removing rusted and stuck drive shafts directly on the vehicle
- Working time: approx. 5 minutes only
- For all passenger cars with 4- and 5-hole wheel hubs due to oval holes for wheel bolts
- Prevents heating of or damage to the drive shaft or damage to other parts

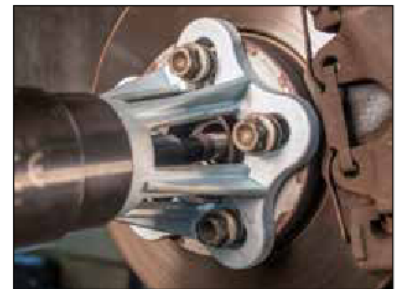
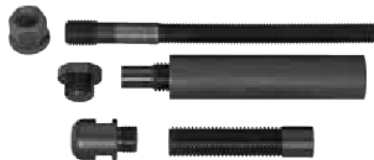

21



**1,348.- €** excl. VAT

**V7862**

EAN 4047728078627



### Axle shaft removal set

- Removal of the inner axle shaft from the gearbox unit
- Full gripping of the axle shaft prevents damage caused by hammering or pulling
- Variable settings of the axle shaft holder allow optimum access to the shaft
- Depending on the installation situation, the holder can be disassembled into two parts and clamped around the axle shaft
- Universally adjustable holder allows use from small cars to commercial vehicles
- Use with 5 kg sliding hammer V2922

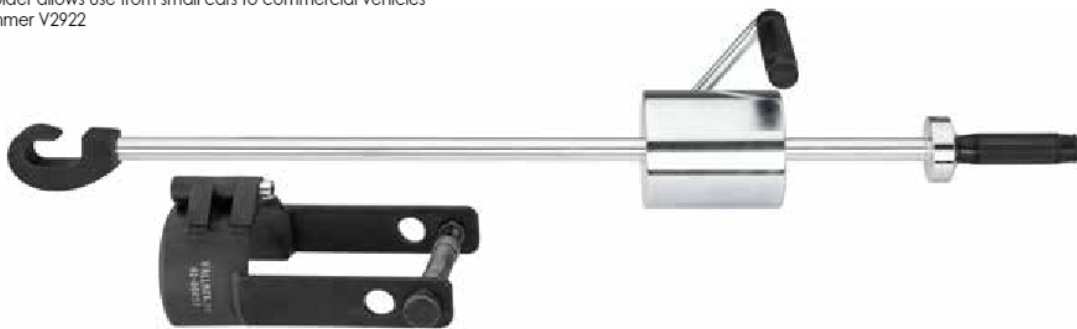

VIGOR No.	Designation	Design	EAN 4047728+	€
<b>V7980</b>	Axle shaft holder and holding hook for axle shaft disassembly		079808	569.-
<b>V2922</b>	Sliding hammer 5 kg		029223	356.94

3



**899.- €** excl. VAT

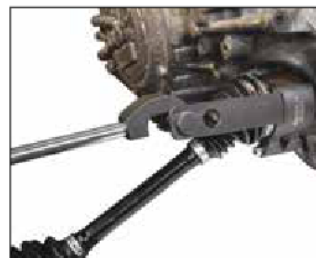

**V7133**

EAN 4047728071338

181/221 SUV Van



## Compact wheel bearing removal / installation set

- Including multibox
- Operating all compact wheel bearings from Smart to the Sprinter
- Utilised assembly unit V4491 ensures professional installation of the second generation compact wheel bearing
- Contents: Special unit for installing the closed wheel bearing and a universal set for all other compact wheel bearings diameters
- Cost and time savings by eliminating the need to install a new steering knuckle, the subsequent axle alignment and the associated additional work
- Including two V4700-L multiboxes



**V7133N**

EAN 4047728071703

181/221 SUV Van



## Compact wheel bearing installation expansion set

- Operation of compact wheel bearings on Sprinter · Vito · Viano · Crafter
- Recommendation: use of a conventional tool set is not possible as a closed wheel bearing is fitted. Drive with a spindle system is not possible
- Special set for installing the wheel bearing closed at the wheel hub for the following vehicles, among others: **MERCEDES-BENZ** V-Class model year 2014 → · Viano model year 2003 → · Vito box model year 2014 → · Sprinter model year 2008 → **VOLKSWAGEN** Crafter model year 2011 →
- Cost and time savings by eliminating the need to install a new steering knuckle, the subsequent axle alignment and the associated additional work
- Basic requirements: Assembly unit for compact wheel bearing V4491 as well as drive unit, e.g. hydraulic cylinder V4551 or V2854
- Including multibox





**V4476N**

EAN 4047728068000



## Hydraulic spring vice

- Can be used for almost any strut and shock absorber in passenger cars as well as lightweight vans

## What you should know!

- Also suitable for **MERCEDES-BENZ** C-Class (W203), newer **BMW** and **VAG** spring struts, with electronic shock absorbers (EDC, DCC)
- By gripping the springs within the spring windings, any possible disruptive parts on the shock absorber are irrelevant and have no influence on the operation of the spring vice
- Precise alignment of spring and shock absorber struts
- Also for separating steering knuckles and spring struts by relieving the load on the spring strut directly on the vehicle without dismantling the axle shaft. Any mandatory axle alignments are no longer required!
- Reverse placement of the supporting frame allows the spring vice to be used as an additional hydraulic support and can be used with 2.1 t of power, e.g. for work on control arms or supporting joints
- Quick pin mechanism allows quick and easy repositioning of the spring vice in order to use the 3 functions: gripping the spring, separating the steering knuckle from the spring strut and as a hydraulic support
- Stroke: 430 mm

Take a look!



2.1t

Including 10 spring plates



A safety tool with technical sophistication!



16

2,200.- € excl. VAT

### ① Pre-tensioning the spring

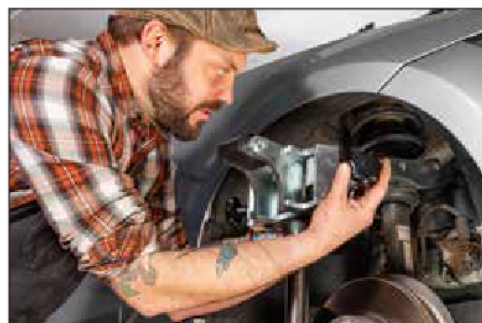

### ② Tensioning the spring



### ③ Support device

