

# SW-Stahl

HAND & SPECIALIST TOOLS



## MAIN CATALOGUE

- CARS
- TRUCKS
- COMMERCIAL VEHICLES
- INDUSTRIAL
- AGRICULTURAL
- SAUER – DAS WERKZEUG



# SW-STAHL

# 30th ANNIVERSARY

## 30 years SW-Stahl – always on the move

SW-Stahl was founded in June 1987 and has become an internationally successful wholesaler for hand tools and automotive specialised tools over the past 30 years. The current range includes over 8500 high-quality solutions for endless applications.

In collaboration with their experienced team of technicians, automotive experts and a proficient sales and marketing team SW-Stahl develops solutions for the automotive aftermarket, the business-to-business sectors and trade.

In 2013 Heiner Tilly took over the company and made various changes to prepare the company for the challenges in the years to come.





- Modern Logistics processes (Drop Shipment)
- Its own engineering team
- Creative in-house marketing
- Digital processes (Tec Doc, Tec Com, EDI)

A young, motivated and flexible team is available at any time for our customers in Germany, Austria and the whole of Europe. 30 years of high-quality service.



# CONTENTS



	<b>SPANNERS</b>	<b>4-33</b>	
	<b>SOCKETS / RATCHETS / ACCESSORIES</b>	<b>34-107</b>	
	<b>BITS AND BIT INSERTS</b>	<b>108-127</b>	
	<b>SCREWING TOOLS</b>	<b>128-153</b>	
	<b>PLIERS</b>	<b>154-179</b>	
	<b>OTHER HAND TOOLS</b>	<b>180-237</b>	
	<b>AIR TOOLS</b>	<b>238-257</b>	
	<b>POWER / CORDLESS TOOLS</b>	<b>258-267</b>	
	<b>TORQUE TOOLS</b>	<b>268-277</b>	
	<b>DIAGNOSIS AND TESTING UNITS</b>	<b>278-287</b>	
	<b>ENGINE</b>	<b>288-409</b>	
	<b>GEARBOX / CLUTCH</b>	<b>410-419</b>	
	<b>EXHAUST</b>	<b>420-429</b>	
	<b>AIR CONDITION</b>	<b>430-433</b>	
	<b>STEERING / SUSPENSION</b>	<b>434-501</b>	
	<b>WHEEL / TYRE</b>	<b>502-523</b>	
	<b>BRAKES</b>	<b>524-553</b>	
	<b>BODY</b>	<b>554-603</b>	
	<b>ELECTRICS</b>	<b>604-621</b>	
	<b>TOOL TROLLEY / FOAM INSERTS</b>	<b>622-665</b>	
	<b>TOOL ASSORTMENTS</b>	<b>666-673</b>	
	<b>WORKSHOP EQUIPMENT</b>	<b>674-697</b>	
	<b>WORKSHOP DEMAND</b>	<b>698-729</b>	
	<b>MOTORCYCLE</b>	<b>730-737</b>	
	<b>COMMERCIAL VEHICLES</b>	<b>738-797</b>	
	<b>SAUER - DAS WERKZEUG</b>	<b>798-818</b>	

# SPANNERS





# SPANNERS

4-33



▶ Open-ended Spanners	6-8
▶ Combination Spanners	9-17
▶ Double-Ring Spanners	18-24
▶ Double-Ended Swivel Head Wrenches	24
▶ Slogging Spanners	24-25
▶ Pipe Head Spanners	25
▶ Ratchet Wrenches	26-29
▶ Other Spanners	30-32





## Double open-ended spanner set



manufactured according to DIN 3110 / ISO 10102, ISO 3318, ISO 1085

- spanner heads angled by 15°
- the slim shape as well as narrow heads guarantee a minimal space requirement
- galvanic coating for preventing corrosion
- made from high-quality chrome vanadium steel
- matt chrome plated
- packed in practical plastic tube with EURO-hanger

### Sizes:

6 x 7 mm  
8 x 9 mm  
10 x 11 mm  
12 x 13 mm  
14 x 15 mm  
16 x 17 mm  
18 x 19 mm  
21 x 22 mm



### Description

8-piece, 6 - 22 mm

### Part no.

00150L

## Double open-ended spanner set



manufactured according to DIN 3110 / ISO 10102, ISO 3318, ISO 1085

- spanner heads angled by 15°
- the slim shape as well as narrow heads guarantee a minimal space requirement
- galvanic coating for preventing corrosion
- made of high-quality chrome vanadium steel
- matt chrome plated
- packed in practical plastic tube with EURO-hangers

### Sizes:

6 x 7 mm  
8 x 9 mm  
10 x 11 mm  
12 x 13 mm  
14 x 15 mm  
16 x 17 mm  
18 x 19 mm  
21 x 22 mm  
24 x 27 mm  
30 x 32 mm



### Description

10-piece, 6 - 32 mm

### Part no.

00151L

## Double open-ended spanner



manufactured according to DIN 3110 / ISO 10102, ISO 3318, ISO 1085

- Clevis heads with 15° chamfer
- the slim shape and narrow heads guarantee a minimum space requirement
- galvanic coating for preventing corrosion
- made from high-quality chrome vanadium steel
- mat chrome-plated



Description	Length	Part no.
6 x 7 mm	125 mm	00101L
8 x 9 mm	140 mm	00102L
8 x 10 mm	140 mm	00130L
10 x 11 mm	156 mm	00103L
10 x 13 mm	162 mm	00131L
12 x 13 mm	168 mm	00104L
13 x 17 mm	205 mm	00133L
14 x 15 mm	185 mm	00106L
16 x 17 mm	205 mm	00108L
16 x 18 mm	202 mm	00141L
17 x 19 mm	220 mm	00109L
18 x 19 mm	222 mm	00110L
20 x 22 mm	236 mm	00112L
21 x 22 mm	232 mm	00142L
21 x 23 mm	248 mm	00113L
21 x 24 mm	246 mm	00143L
22 x 24 mm	248 mm	00137L
24 x 26 mm	265 mm	00139L
24 x 27 mm	260 mm	00114L
25 x 28 mm	283 mm	00140L
27 x 32 mm	300 mm	00115L
30 x 32 mm	302 mm	00116L
30 x 36 mm	315 mm	00144L
32 x 36 mm	326 mm	00117L
34 x 36 mm	315 mm	00145L
36 x 41 mm	360 mm	00118L
41 x 46 mm	410 mm	00146L
46 x 50 mm	460 mm	00147L



## Double open-ended spanner

manufactured according to DIN 3110 / ISO 10102, ISO 3318, ISO 1085

- Clevis heads with 15° chamfer
- the slim shape and narrow heads guarantee a minimum space requirement
- galvanic coating for preventing corrosion
- made from high-quality chrome vanadium steel
- mat chrome-plated
- packed on plastic hanger



Description	Length	Part no.
6 x 7 mm	125 mm	00101SB
8 x 9 mm	140 mm	00102SB
8 x 10 mm	142 mm	00130SB
10 x 11 mm	156 mm	00103SB
10 x 13 mm	170 mm	00131SB
12 x 13 mm	168 mm	00104SB
13 x 17 mm	202 mm	00133SB
14 x 15 mm	185 mm	00106SB
16 x 17 mm	205 mm	00108SB
16 x 18 mm	202 mm	00141SB
17 x 19 mm	220 mm	00109SB
18 x 19 mm	222 mm	00110SB
20 x 22 mm	236 mm	00112SB
21 x 22 mm	232 mm	00142SB
21 x 23 mm	248 mm	00113SB
21 x 24 mm	246 mm	00143SB
22 x 24 mm	246 mm	00137SB
24 x 26 mm	265 mm	00139SB
24 x 27 mm	260 mm	00114SB
25 x 28 mm	285 mm	00140SB
27 x 32 mm	300 mm	00115SB
30 x 32 mm	302 mm	00116SB

## Double open-ended spanner set

Chrome-vanadium  
matt chrome-plated



Description	Part no.
8-piece, 6 x 7, 8 x 9, 10 x 11, 12 x 13, 14 x 15, 16 x 17, 18 x 19, 20 x 22mm	01-110-WB

## Double open-ended spanner set

Chrome-vanadium  
chrome-plated, polished heads



Description	Part no.
12-piece, 6 x 7, 8 x 9, 10 x 11, 12 x 13, 14 x 15, 16 x 17, 18 x 19, 20 x 22, 21 x 23, 24 x 26, 25 x 28, 27 x 32 mm	00312L



## Combination spanner set, Pro drive



manufactured according to DIN 3113 form A / ISO 7738, ISO 3318

- the open and ring head are inclined by 15 °
- the slim shape as well as narrow heads guarantee a minimal space requirement
- with SW-Stahl PRO DRIVE profile
- specially recessed shaft profile that prevents slipping or twisting of the bolt
- the enlarged contact surface ensures a secure torque transmission
- the optimally distributed force transmission generates higher torques by up to 20%
- galvanic coating for preventing corrosion
- made of high-quality chrome vanadium
- matt chrome plated
- packed in practical plastic tube with EURO-hangers

### Sizes:

6, 7, 8, 9, 10, 11, 12, 13, 14, 15, 16, 17, 18, 19, 22 mm



### Description

15-piece, 6 - 22 mm

### Part no.

00162L

## Combination spanner set, Pro drive



manufactured according to DIN 3113 form A / ISO 7738, ISO 3318

- the open and ring head are inclined by 15 °
- the slim shape as well as narrow heads guarantee a minimal space requirement
- with SW-Stahl PRO DRIVE profile
- specially recessed shaft profile that prevents slipping or twisting of the bolt
- the enlarged contact surface ensures a secure torque transmission
- the optimally distributed force transmission generates higher torques by up to 20%
- galvanic coating for preventing corrosion
- made of high-quality chrome vanadium
- matt chrome plated
- packed in practical black roll-up pouch

### Sizes:

10, 11, 12, 13, 14, 15, 16, 17,  
18, 19, 21, 22, 24, 27, 30, 32 mm



### Description

16-piece, 10 - 32 mm

### Part no.

00163L

## Combination spanner, Pro drive

manufactured according to DIN 3113 form A / ISO 7738, ISO 3318

- Clevis and ring head each with 15° chamfer
- the slim shape and narrow heads guarantee a minimum space requirement
- with SW-Stahl PRO DRIVE profile
- specific inset corrugated profile which prevents the bolt from slipping or stripping
- the enlarged contact surface ensures a reliable torque transfer
- the optimally distributed transfer of force generates higher torques of up to 20%
- galvanic coating for preventing corrosion
- made from high-quality chrome vanadium steel
- mat chrome-plated



Description	Length	Part no.
6 mm	100 mm	00801L
7 mm	110 mm	00802L
8 mm	125 mm	00803L
9 mm	130 mm	00804L
10 mm	140 mm	00805L
11 mm	150 mm	00806L
12 mm	160 mm	00807L
13 mm	170 mm	00808L
14 mm	183 mm	00809L
15 mm	190 mm	00810L
16 mm	205 mm	00811L
17 mm	210 mm	00812L
18 mm	210 mm	00813L
19 mm	235 mm	00814L
20 mm	250 mm	00815L
21 mm	250 mm	00816L
22 mm	260 mm	00817L
23 mm	270 mm	00818L
24 mm	285 mm	00819L
25 mm	290 mm	00820L
26 mm	310 mm	00821L
27 mm	310 mm	00822L
30 mm	330 mm	00824L
32 mm	365 mm	00825L
34 mm	380 mm	00826L
36 mm	400 mm	00827L
38 mm	410 mm	00828L
41 mm	460 mm	00829L
46 mm	492 mm	00831L
50 mm	535 mm	00832L

## Combination spanner, Pro drive

DIN CrV



manufactured according to DIN 3113 form A / ISO 7738, ISO 3318

- Clevis and ring head each with 15° chamfer
- the slim shape and narrow heads guarantee a minimum space requirement
- with SW-Stahl PRO DRIVE profile
- specific inset corrugated profile which prevents the bolt from slipping or stripping
- the enlarged contact surface ensures a reliable torque transfer
- the optimally distributed transfer of force generates higher torques of up to 20%
- galvanic coating for preventing corrosion
- made from high-quality chrome vanadium steel
- mat chrome-plated
- packed on plastic hanger



Description	Length	Part no.
6 mm	100 mm	00801SB
7 mm	110 mm	00802SB
8 mm	125 mm	00803SB
9 mm	130 mm	00804SB
10 mm	140 mm	00805SB
11 mm	150 mm	00806SB
12 mm	160 mm	00807SB
13 mm	170 mm	00808SB
14 mm	183 mm	00809SB
15 mm	190 mm	00810SB
16 mm	205 mm	00811SB
17 mm	210 mm	00812SB
18 mm	210 mm	00813SB
19 mm	235 mm	00814SB
20 mm	250 mm	00815SB
21 mm	250 mm	00816SB
22 mm	260 mm	00817SB
23 mm	270 mm	00818SB
24 mm	285 mm	00819SB
25 mm	290 mm	00820SB
26 mm	310 mm	00821SB
27 mm	310 mm	00822SB
30 mm	330 mm	00824SB
32 mm	365 mm	00825SB





## Combination spanner set, Pro drive

- the open and ring head are inclined by 15 °
- the slim shape as well as narrow heads guarantee a minimal space requirement
- with SW-Stahl PRO DRIVE profile
- specially recessed shaft profile that prevents slipping or twisting of the bolt
- the enlarged contact surface ensures a secure torque transmission
- the optimally distributed force transmission generates higher torques by up to 20%
- galvanic coating for preventing corrosion
- made of high-quality chrome vanadium
- matt chrome plated
- packed in practical plastic tube with EURO-hangers



### Sizes:

1/4, 5/16, 3/8, 7/16, 1/2, 9/16, 5/8, 3/4"

### Description

8-piece, 1/4 - 3/4"

### Part no.

00166L

## Combination spanner set, Extra short



Chrome-vanadium, extra short, glare-free

For tight swivelling angles and spots that are difficult to access, e.g. on air-conditioning systems, instruments, during radio installation, in the door and engine area.

Length between 90 and 140 mm



### Description

10-piece  
10, 11, 12, 13, 14, 15, 16, 17, 18, 19 mm

### Part no.

00840L

## Combination spanner set, Extra long



Chrome-vanadium, matt chrome-plated, in black roll-up pouch.

- Extra long version enables high power transmission
- Hardness and torque exceed the requirements of the relevant DIN standards



### Description

14-piece,  
6, 7, 8, 9, 10, 11, 12, 13, 14, 15, 16, 17, 18, 19 mm  
6-piece,  
21, 22, 24, 27, 30, 32 mm

### Part no.

00830L

00835L

## Combination spanner, Extra long



Chrome-vanadium, chrome-plated and high-gloss polished

- Extra-long version makes maximum transmission of force possible
- Hardness and torque exceed the requirements of the respective DIN standards



Size	Length	Part no.
6 mm	125 mm	00830L-6
7 mm	135 mm	00830L-7
8 mm	145 mm	00830L-8
9 mm	155 mm	00830L-9
10 mm	170 mm	00830L-10
11 mm	180 mm	00830L-11
12 mm	195 mm	00830L-12
13 mm	205 mm	00830L-13
14 mm	220 mm	00830L-14
15 mm	230 mm	00830L-15
16 mm	240 mm	00830L-16
17 mm	255 mm	00830L-17
18 mm	265 mm	00830L-18
19 mm	280 mm	00830L-19
21 mm	300 mm	00835L-21
22 mm	310 mm	00835L-22
24 mm	335 mm	00835L-24
27 mm	355 mm	00835L-27
30 mm	420 mm	00835L-30
32 mm	440 mm	00835L-32

## Combination spanner set, Extra long



Jumbo combination spanner set, maximum material strength, suitable for use on trucks. In black roll-up pouch.

- Spanner size 34 x 440 mm long
- Spanner size 36 x 445 mm long
- Spanner size 38 x 470 mm long
- Spanner size 41 x 495 mm long
- Spanner size 46 x 540 mm long
- Spanner size 50 x 600 mm long



**extra-long and extremely strong**

Description	Part no.
6-piece, 34, 36, 38, 41, 46, 50 mm	00927L

## Combination wrench, Extra long



Jumbo combination wrench, extra-strong, for use on commercial vehicles



**extra-long**

Description	Part no.
34 x 440 mm	00927L-34
36 x 445 mm	00927L-36
38 x 470 mm	00927L-38
41 x 495 mm	00927L-41
46 x 540 mm	00927L-46
50 x 600 mm	00927L-50
55 x 620 mm	00927L-55





## Combination spanner set

Chrome-vanadium, matt chrome-plated



Description	Part no.
8-piece, 8, 9, 10, 12, 13, 14, 17, 19 mm	<b>01-121-WB</b>
12-piece, 6, 7, 8, 9, 10, 11, 12, 13, 14, 17, 19, 22 mm	<b>01-122-WB</b>

## Combination spanner set

Chrome-vanadium steel, chrome-plated, polished heads.



Description	Part no.
8-piece, 6, 8, 10, 11, 13, 14, 17, 19 mm	<b>00908L</b>
12-piece, 6, 8, 7, 9, 10, 11, 12, 13, 14, 17, 19, 22 mm	<b>00912L</b>
25-piece, 6, 7, 8, 9, 10, 11, 12, 13, 14, 15, 16, 17, 18, 19, 20, 21, 22, 23, 24, 25, 26, 27, 28, 30, 32 mm	<b>00925L</b>

## Combination spanner set

Chrome-vanadium, matt chrome-plated, glare-free surface.



Description	Part no.
19-piece, 8-9-10-11-12-13-14-15-16-17-18-19-20-21-22-24-27-30-32 mm	<b>00919L</b>

## Combination spanner set

Chrome-vanadium, matt chromed



Aston Martin  
Austin  
Austin Morris  
Austin Rover  
Bentley  
Harley Davidson  
Rolls Royce  
Rover

Description	Part no.
25-piece, 1/4, 9/32, 5/16, 11/32, 3/8, 7/16, 15/32, 1/2, 9/16, 19/32, 5/8, 11/16, 23/32, 3/4, 25/32, 13/16, 7/8, 29/32, 15/16, 1, 1 1/32, 1 1/16, 1 1/8, 1 3/16, 1 1/4"	<b>00922L</b>

## Combination spanner set, PRO DRIVE



manufactured according to DIN 3113 form B / ISO 7738, ISO 3318

- ring head 10 ° cranked
- ideal for tightening and loosening low-lying screws
- fork head inclined by 15 °
- the slim shape as well as narrow heads guarantee a minimal space requirement
- with SW-Stahl PRO DRIVE profile
- specially recessed shaft profile that prevents slipping or twisting of the screw
- the enlarged contact surface ensures a secure torque transmission
- the optimally distributed force transmission generates higher torques by up to 20%
- galvanic coating for preventing corrosion
- made of high-quality chrome vanadium
- matt chrome plated
- packed in practical plastic tube with EURO-hangers

### Sizes:

6, 7, 8, 9, 10, 11, 12, 13, 14, 15, 16, 17, 18, 19, 22 mm



### Description

15-piece, 6 - 22 mm

### Part no.

00192L

## Combination spanner set, PRO DRIVE



manufactured according to DIN 3113 form B / ISO 7738, ISO 3318

- ring head 10 ° cranked
- ideal for tightening and loosening low-lying screws
- fork head inclined by 15 °
- the slim shape as well as narrow heads guarantee a minimal space requirement
- with SW-Stahl PRO DRIVE profile
- specially recessed shaft profile that prevents slipping or twisting of the screw
- the enlarged contact surface ensures a secure torque transmission
- the optimally distributed force transmission generates higher torques by up to 20%
- galvanic coating for preventing corrosion
- made of high-quality chrome vanadium
- matt chrome plated
- packed in practical black roll-up pouch

### Sizes:

10, 11, 12, 13, 14, 15, 16, 17,  
18, 19, 21, 22, 24, 27, 30, 32 mm

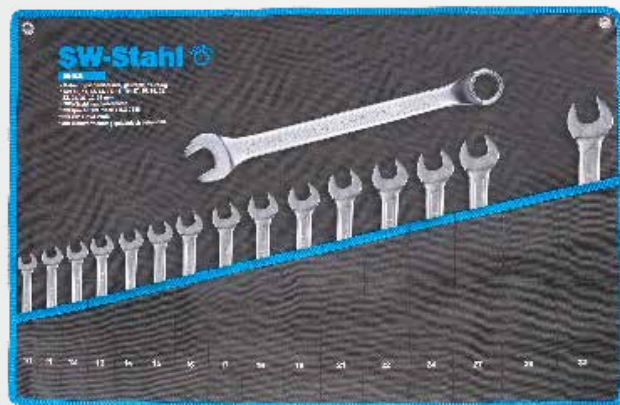

### Description

16-piece, 10 - 32 mm

### Part no.

00193L





## Combination spanner, PRO DRIVE



manufactured according to DIN 3113 form B / ISO 7738, ISO 3318

- Ring head cranked by 10°
- ideal for tightening and loosening sunken bolts
- Clevis head with 15° chamfer
- the slim shape and narrow heads guarantee a minimum space requirement
- with SW-Stahl PRO DRIVE profile
- specific inset corrugated profile which prevents the bolt from slipping or stripping
- the enlarged contact surface ensures a reliable torque transfer
- the optimally distributed transfer of force generates higher torques of up to 20%
- galvanic coating for preventing corrosion
- made from high-quality chrome vanadium steel
- mat chrome-plated



Description	Length	Part no.
6 mm	100 mm	00203L
7 mm	110 mm	00204L
8 mm	120 mm	00205L
9 mm	130 mm	00206L
10 mm	155 mm	00207L
11 mm	162 mm	00208L
12 mm	170 mm	00209L
13 mm	178 mm	00210L
14 mm	192 mm	00211L
15 mm	210 mm	00212L
16 mm	220 mm	00213L
17 mm	236 mm	00214L
18 mm	240 mm	00215L
19 mm	246 mm	00216L
20 mm	260 mm	00217L
21 mm	270 mm	00218L
22 mm	275 mm	00219L
23 mm	320 mm	00220L
24 mm	320 mm	00221L
25 mm	343 mm	00222L
26 mm	343 mm	00223L
27 mm	370 mm	00224L
28 mm	370 mm	00225L
29 mm	395 mm	00226L
30 mm	395 mm	00227L
32 mm	418 mm	00228L



## Combination spanner, PRO DRIVE

DIN CrV



manufactured according to DIN 3113 form B / ISO 7738, ISO 3318

- Ring head cranked by 10°
- ideal for tightening and loosening sunken bolts
- Clevis head with 15° chamfer
- the slim shape and narrow heads guarantee a minimum space requirement
- with SW-Stahl PRO DRIVE profile
- specific inset corrugated profile which prevents the bolt from slipping or stripping
- the enlarged contact surface ensures a reliable torque transfer
- the optimally distributed transfer of force generates higher torques of up to 20%
- galvanic coating for preventing corrosion
- made from high-quality chrome vanadium steel
- mat chrome-plated
- packed on plastic hanger



Description	Length	Part no.
6 mm	100 mm	00203SB
7 mm	110 mm	00204SB
8 mm	120 mm	00205SB
9 mm	130 mm	00206SB
10 mm	155 mm	00207SB
11 mm	162 mm	00208SB
12 mm	170 mm	00209SB
13 mm	178 mm	00210SB
14 mm	192 mm	00211SB
15 mm	210 mm	00212SB
16 mm	220 mm	00213SB
17 mm	236 mm	00214SB
18 mm	240 mm	00215SB
19 mm	246 mm	00216SB
20 mm	260 mm	00217SB
21 mm	270 mm	00218SB
22 mm	275 mm	00219SB
23 mm	320 mm	00220SB
24 mm	320 mm	00221SB
25 mm	343 mm	00222SB
26 mm	343 mm	00223SB
27 mm	370 mm	00224SB
28 mm	370 mm	00225SB
29 mm	395 mm	00226SB
30 mm	395 mm	00227SB
32 mm	418 mm	00228SB



## Double-ring spanner set, PRO DRIVE

manufactured according to DIN 837 / ISO 1085

- the open and ring head are inclined by 15 °
- the slim shape as well as narrow heads guarantee a minimal space requirement
- with SW-Stahl PRO DRIVE profile
- specially recessed shaft profile that prevents slipping or twisting of the bolt
- the enlarged contact surface ensures a secure torque transmission
- the optimally distributed force transmission generates higher torques by up to 20%
- galvanic coating for preventing corrosion
- made of high-quality chrome vanadium
- matt chrome plated
- packed in practical plastic tube with EURO-hangers

### Sizes:

- 6 x 7 mm
- 8 x 9 mm
- 10 x 11 mm
- 12 x 13 mm
- 14 x 15 mm
- 16 x 17 mm
- 18 x 19 mm
- 21 x 22 mm



Description	Part no.
8-piece, 6 - 22 mm	00170L

## Double-ring spanner, PRO DRIVE

manufactured according to DIN 837 / ISO 1085

- straight version
- the slim shape and narrow heads guarantee a minimum space requirement
- with SW-Stahl PRO DRIVE profile
- specific inset corrugated profile which prevents the bolt from slipping or stripping
- the enlarged contact surface ensures a reliable torque transfer
- the optimally distributed transfer of force generates higher torques of up to 20%
- galvanic coating for preventing corrosion
- made from high-quality chrome vanadium steel
- mat chrome-plated



Description	Length	Part no.
6 x 7 mm	100 mm	01301L
8 x 9 mm	115 mm	01302L
10 x 11 mm	128 mm	01304L
12 x 13 mm	142 mm	01305L
14 x 15 mm	157 mm	01308L
16 x 17 mm	171 mm	01310L
17 x 19 mm	189 mm	01311L
18 x 19 mm	190 mm	01312L
20 x 22 mm	210 mm	01313L
21 x 22 mm	230 mm	01315L
21 x 23 mm	210 mm	01314L
24 x 27 mm	256 mm	01316L
30 x 32 mm	312 mm	01317L

## Double-ring spanner, PRO DRIVE



manufactured according to DIN 837 / ISO 1085

- straight version
- the slim shape and narrow heads guarantee a minimum space requirement
- with SW-Stahl PRO DRIVE profile
- specific inset corrugated profile which prevents the bolt from slipping or stripping
- the enlarged contact surface ensures a reliable torque transfer
- the optimally distributed transfer of force generates higher torques of up to 20%
- galvanic coating for preventing corrosion
- made from high-quality chrome vanadium steel
- mat chrome-plated
- packed on plastic hanger



Description	Length	Part no.
6 x 7 mm	100 mm	01301SB
8 x 9 mm	115 mm	01302SB
10 x 11 mm	128 mm	01304SB
12 x 13 mm	142 mm	01305SB
14 x 15 mm	157 mm	01308SB
16 x 17 mm	171 mm	01310SB
17 x 19 mm	189 mm	01311SB
18 x 19 mm	190 mm	01312SB
20 x 22 mm	210 mm	01313SB
21 x 22 mm	230 mm	01315SB
21 x 23 mm	210 mm	01314SB
24 x 27 mm	256 mm	01316SB
30 x 32 mm	312 mm	01317SB

## Double-ring spanner, Extra long



- chrome-vanadium
- extra-long
- straight version
- mirror-polished
- high-strength, e.g. for supporting joints, steering knuckle screw attachments, propeller shaft flanges (also for trucks before towing)



Mercedes-Benz LKW  
Iveco LKW  
General Motors LKW  
Fiat LKW  
Volvo LKW  
Scania LKW  
Mitsubishi LKW

Description	Length	Height	Part no.
10 x 11 mm	320 mm	10 mm	01351L
12 x 14 mm	330 mm	11 mm	01352L
13 x 15 mm	365 mm	14 mm	01353L
17 x 19 mm	395 mm	16 mm	01354L
16 x 18 mm	365 mm	14 mm	01357L
21 x 23 mm	435 mm	18 mm	01356L
22 x 24 mm	435 mm	18 mm	01355L

## Double-ring spanner, E Profile



with flat shape for special E-profile screws  
Chrom-vanadium, matt chrome-plated



Description	Part no.
4-piece E6xE8, E10xE12, E14xE18, E20xE24	01550L
6-piece E6xE8, E7xE11, E10xE12, E14xE18, E16xE22, E20xE24	01560L



## Double-ring spanner, E Profile



with flat shape for special E-profile screws  
Chrom-vanadium, matt chrome-plated



Description	Length	Height	Part no.
E6 x E8	115 mm	5 mm	01551L
E10 x E12	143 mm	8 mm	01552L
E14 x E18	183 mm	10 mm	01553L
E16 x E22	204 mm	11 mm	01556L
E20 x E24	225 mm	12 mm	01554L

## Double-ring spanner set, PRO DRIVE



manufactured according to DIN 838 / ISO 10104, ISO 3318, ISO 1085

- with deep cranked ring heads
- ideal for tightening and loosening sunken bolts
- the slim shape as well as narrow heads guarantee a minimal space requirement
- with SW-Stahl PRO DRIVE profile
- specially recessed shaft profile that prevents slipping or twisting of the screw
- the enlarged contact surface ensures a secure torque transmission
- the optimally distributed force transmission generates higher torques by up to 20%
- galvanic coating for preventing corrosion
- made from high-quality chrome vanadium
- matt chrome plated
- packed in practical plastic tube with EURO-hangers

### Sizes:

- 6 x 7 mm
- 8 x 9 mm
- 10 x 11 mm
- 12 x 13 mm
- 14 x 15 mm
- 16 x 17 mm
- 18 x 19 mm
- 20 x 22 mm



Description	Part no.
8-piece, 6 - 22 mm	00180L

## Double-ring spanner set, PRO DRIVE

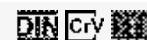

manufactured according to DIN 838 / ISO 10104, ISO 3318, ISO 1085

- with deep cranked ring heads
- ideal for tightening and loosening sunken bolts
- the slim shape as well as narrow heads guarantee a minimal space requirement
- with SW-Stahl PRO DRIVE profile
- specially recessed shaft profile that prevents slipping or twisting of the screw
- the enlarged contact surface ensures a secure torque transmission
- the optimally distributed force transmission generates higher torques by up to 20%
- galvanic coating for preventing corrosion
- made of high-quality chrome vanadium
- matt chrome plated
- packed in practical black roll-up pouch



### Sizes:

- 6 x 7 mm
- 8 x 9 mm
- 10 x 11 mm
- 12 x 13 mm
- 14 x 15 mm
- 16 x 17 mm
- 18 x 19 mm
- 20 x 22 mm
- 21 x 23 mm
- 24 x 27 mm
- 30 x 32 mm

### Description

11-piece, 6 - 32 mm

### Part no.

00181L



## Double-ring spanner, PRO DRIVE

manufactured according to DIN 838 / ISO 10104, ISO 3318, ISO 1085

- with deep cranked ring heads
- ideal for tightening and loosening sunken bolts
- the slim shape and narrow heads guarantee a minimum space requirement
- with SW-Stahl PRO DRIVE profile
- specific inset corrugated profile which prevents the bolt from slipping or stripping
- the enlarged contact surface ensures a reliable torque transfer
- the optimally distributed transfer of force generates higher torques of up to 20%
- galvanic coating for preventing corrosion
- made from high-quality chrome vanadium steel
- mat chrome-plated



Description	Length	Part no.
6 x 7 mm	180 mm	01201L
8 x 9 mm	195 mm	01202L
10 x 11 mm	202 mm	01204L
12 x 13 mm	220 mm	01207L
14 x 15 mm	235 mm	01210L
16 x 17 mm	248 mm	01212L
17 x 19 mm	295 mm	01213L
18 x 19 mm	269 mm	01214L
20 x 22 mm	290 mm	01215L
21 x 23 mm	320 mm	01216L
24 x 27 mm	340 mm	01218L
27 x 32 mm	360 mm	01221L
30 x 32 mm	380 mm	01222L
30 x 36 mm	410 mm	01225L
32 x 36 mm	415 mm	01223L
36 x 41 mm	435 mm	01224L
41 x 46 mm	485 mm	01226L
46 x 50 mm	540 mm	01227L

## Double-ring spanner, PRO DRIVE

DIN CrV



manufactured according to DIN 838 / ISO 10104, ISO 3318, ISO 1085

- with deep cranked ring heads
- ideal for tightening and loosening sunken bolts
- the slim shape and narrow heads guarantee a minimum space requirement
- with SW-Stahl PRO DRIVE profile
- specific inset corrugated profile which prevents the bolt from slipping or stripping
- the enlarged contact surface ensures a reliable torque transfer
- the optimally distributed transfer of force generates higher torques of up to 20%
- galvanic coating for preventing corrosion
- made from high-quality chrome vanadium steel
- mat chrome-plated
- packed on plastic hanger



Description	Length	Part no.
6 x 7 mm	180 mm	01201SB
8 x 9 mm	195 mm	01202SB
10 x 11 mm	202 mm	01204SB
12 x 13 mm	220 mm	01207SB
14 x 15 mm	235 mm	01210SB
16 x 17 mm	248 mm	01212SB
17 x 19 mm	295 mm	01213SB
18 x 19 mm	269 mm	01214SB
20 x 22 mm	290 mm	01215SB
21 x 23 mm	320 mm	01216SB
24 x 27 mm	340 mm	01218SB
27 x 32 mm	360 mm	01221SB
30 x 32 mm	380 mm	01222SB

## Double-ring spanner set

CrV

Chrome-vanadium, matt chrome-plated  
double cropped



Description	Part no.
8-piece 6x7, 8x9, 10x11, 12x13, 14x15, 16x17, 18x19, 20x22 mm	01508L
12-piece 6x7, 8x9, 10x11, 12x13, 14x15, 16x17, 18x19, 20x22, 21x23, 24x26, 25x28, 27x32 mm	01512L

## Double-ring spanner set

CrV

Chrome-vanadium, matt chrome-plated  
double cropped, in display box



Description	Part no.
8-piece set 6x7, 8x9, 10x11, 12x13, 14x15, 16x17, 18x19, 20x22 mm	01-141-WB



# Double-Ring Spanners



## Double-ring spanner set, E Profile

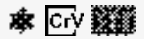

Chrome-vanadium, matt chrome-plated, double cropped

- E6 x E8
- E7 x E11
- E10 x E12
- E14 x E18
- E16 x E22
- E20 x E24



Description  
6-piece

Part no.  
01580L

## Double-Ended Swivel Head Wrenches

### Articulated wrench

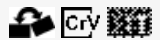

Chrome-vanadium, matt chromium-plated.  
Articulated socket to enable work  
in cramped places



Description  
8 x 9 mm  
10 x 11 mm  
12 x 13 mm  
14 x 15 mm  
16 x 17 mm  
18 x 19 mm

Part no.  
00941L  
00942L  
00943L  
00944L  
00945L  
00946L

## Slogging Spanners

### Slogging ring wrench, Double hexagon



manufactured according to DIN 7444

- For use with heavy assemblies in particular
- made from high-quality chrome vanadium steel
- burnished



Size  
27 mm  
30 mm  
32 mm  
36 mm  
41 mm  
46 mm  
50 mm  
55 mm  
60 mm  
65 mm  
70 mm  
75 mm  
80 mm  
85 mm  
90 mm  
95 mm

Length  
180 mm  
196 mm  
196 mm  
205 mm  
229 mm  
239 mm  
256 mm  
271 mm  
280 mm  
300 mm  
326 mm  
326 mm  
357 mm  
359 mm  
400 mm  
400 mm

Part no.  
00257L  
00258L  
00262L  
00264L  
00265L  
00266L  
00267L  
00269L  
00270L  
00271L  
00272L  
00273L  
00274L  
00275L  
00276L  
00279L



## Open-ended slogging wrench



manufactured according to DIN 133

- for use with heavy assemblies in particular
- made from high-quality chrome vanadium steel
- burnished



Size	Length	Part no.
27 mm	180 mm	00280L
30 mm	190 mm	00281L
32 mm	195 mm	00285L
36 mm	215 mm	00287L
41 mm	235 mm	00288L
46 mm	255 mm	00289L
50 mm	280 mm	00290L
55 mm	310 mm	00291L
60 mm	330 mm	00292L
65 mm	345 mm	00293L
70 mm	370 mm	00294L
75 mm	395 mm	00295L
80 mm	405 mm	00296L
85 mm	405 mm	00297L
90 mm	455 mm	00298L
95 mm	455 mm	00299L

## Pipe Head Spanners

### Pipe head spanner



solid, long leg hexagon profile, short leg 90° bent with bi-hex profile



Size	Length	Height	Part no.
6 mm	102 mm	9 mm	04506L
7 mm	108 mm	10 mm	04507L
8 mm	115 mm	11 mm	04508L
9 mm	120 mm	13 mm	04509L
10 mm	125 mm	15 mm	04510L
11 mm	138 mm	16 mm	04511L
12 mm	145 mm	17 mm	04512L
13 mm	150 mm	18 mm	04513L
14 mm	162 mm	20 mm	04514L
15 mm	173 mm	22 mm	04515L
16 mm	181 mm	23 mm	04516L
17 mm	190 mm	25 mm	04517L
18 mm	193 mm	25 mm	04518L
19 mm	204 mm	27 mm	04519L
20 mm	212 mm	24 mm	04520L
21 mm	224 mm	30 mm	04521L
22 mm	248 mm	31 mm	04522L
23 mm	260 mm	33 mm	04523L
24 mm	275 mm	33 mm	04524L
25 mm	285 mm	34 mm	04525L
26 mm	290 mm	36 mm	04526L
27 mm	282 mm	37 mm	04527L
28 mm	310 mm	38 mm	04528L
29 mm	305 mm	40 mm	04529L
30 mm	317 mm	40 mm	04530L





## Ring ratchet spanner set, Double hexagon

For spots that are difficult to reach, e.g. turbocharger bolted connections etc.



- chrome-vanadium, polished
- with infinitely adjustable joint on ring spanner insert, can be angled up to 180°
- ring spanner inserts 72 teeth 8 – 9 – 10 – 11 – 12 – 13 – 14 – 15 – 16 – 17 - 18 – 19 mm
- special ratchet 48 teeth, 360° lockable



Description

13-piece

Part no.

S1588

## Combination ratchet wrench set

Chrome-vanadium, matt chrome-plated, finely toothed with 72 teeth.

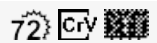

Description

12-piece,  
8, 9, 10, 11, 12, 13, 14, 15, 16, 17, 18, 19 mm

Part no.

S1595

## Combination ratchet wrench

Chrome-vanadium, matt chrome-plated, finely toothed with 72 teeth.



Size	Length	Height	Part no.
8 mm	135 mm	8 mm	S1595-8
9 mm	155 mm	8 mm	S1595-9
10 mm	155 mm	9 mm	S1595-10
11 mm	165 mm	9 mm	S1595-11
12 mm	165 mm	9 mm	S1595-12
13 mm	175 mm	9 mm	S1595-13
14 mm	185 mm	9 mm	S1595-14
15 mm	200 mm	10 mm	S1595-15
16 mm	206 mm	10 mm	S1595-16
17 mm	222 mm	10 mm	S1595-17
18 mm	237 mm	10 mm	S1595-18
19 mm	247 mm	10 mm	S1595-19
21 mm	280 mm	13 mm	S1595-21
22 mm	280 mm	13 mm	S1595-22
24 mm	308 mm	13 mm	S1595-24
27 mm	326 mm	15 mm	S1595-27
30 mm	425 mm	18 mm	S1595-30
32 mm	425 mm	18 mm	S1595-32

## Combination ratchet wrench, Extra short

72 CrV

Extra-short, chrome-vanadium, matt chrome-plated, finely toothed with 72 teeth, Can be switched right / left



Size	Length	Height	Part no.
8 mm	90 mm	10 mm	S1596-8
9 mm	92 mm	10 mm	S1596-9
10 mm	96 mm	12 mm	S1596-10
11 mm	103 mm	12 mm	S1596-11
12 mm	106 mm	13 mm	S1596-12
13 mm	108 mm	13 mm	S1596-13
14 mm	115 mm	14 mm	S1596-14
15 mm	119 mm	14 mm	S1596-15
16 mm	123 mm	15 mm	S1596-16
17 mm	126 mm	15 mm	S1596-17
18 mm	130 mm	15 mm	S1596-18
19 mm	138 mm	17 mm	S1596-19

## Combination ratchet wrench set

72 CrV

reversible, chromium-plated, polished surface

- 72 fine teeth
- flat reverse lever
- Jaw position 15°
- Ring offset 15°



Description	Part no.
12-piece, 8 - 19 mm	S1593
8-piece, 8-10-13-15-16-17-18-19 mm	S1589

## Combination ratchet wrench

72 CrV

switchable, chrome-plated, polished finish

- 72 teeth, fine-toothed
- flat ratchet lever
- jaw position 15°
- ring offset 15°



Size	Length	Height	Part no.
8 mm	145 mm	6,5 mm	S1593-8
9 mm	150 mm	7 mm	S1593-9
10 mm	145 mm	7,3 mm	S1593-10
11 mm	165 mm	7,7 mm	S1593-11
12 mm	172 mm	8,3 mm	S1593-12
13 mm	185 mm	8,6 mm	S1593-13
14 mm	190 mm	9 mm	S1593-14
15 mm	200 mm	9,4 mm	S1593-15
16 mm	208 mm	9,9 mm	S1593-16
17 mm	225 mm	9,9 mm	S1593-17
18 mm	237 mm	10,7 mm	S1593-18
19 mm	248 mm	11,2 mm	S1593-19
22 mm	290 mm	13 mm	S1593-22
24 mm	323 mm	14,5 mm	S1593-24





## Combination ratchet wrench set, outer multi-profile "4 in 1"

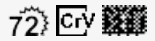

Chrome-vanadium, matt chrome-plated, with 72 teeth, ring side in multi-profile - suitable for metric, inch, hexagon, double-hexagon and E-profile screws



Description	Part no.
7-piece, 8, 10, 12, 13, 14, 17, 19 mm	<b>S1594</b>

## Combination ratchet wrench set, Double hexagon



Chrome-vanadium, matt chrome-plated, with continuous joint on the ring spanner, finely toothed with 72 teeth



Description	Part no.
12-piece, 8, 9, 10, 11, 12, 13, 14, 15, 16, 17, 18, 19 mm	<b>S1597</b>

## Combination ratchet wrench set, Double hexagon



Chrome-vanadium, matt chrome-plated, with continuous joint on the ring spanner, finely toothed with 72 teeth

In practical bag with sizes printed on



Description	Part no.
8-piece, 8, 10, 13, 15, 16, 17, 18, 19 mm	<b>S1598</b>

## Combination ratchet wrench, Double hexagon



Chrome-vanadium, matt chrome-plated, with continuous joint on the ring spanner, finely toothed with 72 teeth



Size	Length	Height	Part no.
8 mm	135 mm	8 mm	S1597-8
9 mm	155 mm	9 mm	S1597-9
10 mm	155 mm	9 mm	S1597-10
11 mm	175 mm	9 mm	S1597-11
12 mm	175 mm	9 mm	S1597-12
13 mm	185 mm	9 mm	S1597-13
14 mm	195 mm	9 mm	S1597-14
15 mm	215 mm	10 mm	S1597-15
16 mm	210 mm	10 mm	S1597-16
17 mm	230 mm	10 mm	S1597-17
18 mm	245 mm	10 mm	S1597-18
19 mm	245 mm	10 mm	S1597-19

## Double-ring ratchet wrench, Double hexagon



Chrome-vanadium, matt chrome-plated, finely toothed with 72 teeth



Description	Length	Height	Part no.
10 x 11 mm	150 mm	8 mm	S1599-10x11
12 x 13 mm	170 mm	9 mm	S1599-12X13
14 x 15 mm	190 mm	10 mm	S1599-14X15
17 x 19 mm	230 mm	11 mm	S1599-17x19

## Double-ring ratchet spanner set, Double hexagon

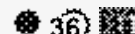

Carbon steel, chrome-plated, flat, switchable



Description	Part no.
5-piece, 6x8, 10x11, 13x14, 15x17, 19x22 mm	03410L

## Ratchet ring spanner set, E Profile



Optimum transmission of force onto the screw and short swivelling angle (5°) thanks to 72 teeth



Description	Part no.
4-piece, E6xE8 - E10xE12 - E14xE18 - E20xE24	03415L

## Double-ring ratchet spanner set, Double hexagon



Chrome-vanadium, matt chrome-plated, fine-toothed with 72 teeth, ratchet can be turned infinitely through 90° thanks to joint



Description	Part no.
4-piece, 10x11 - 12x13 - 14x15 - 17x19 mm	S1592





## Spanner assortment

Chrome-vanadium, matt chrome-plated, inch and metric sizes



Harley Davidson

- 20 jaw ring spanners:  
10, 11, 12, 13, 14, 15, 16, 17, 18, 19 mm  
1/4", 5/16", 3/8", 7/16", 1/2", 9/16", 5/8", 11/16", 3/4", 7/8"
- 10 starter block spanners:  
8 x 10, 11 x 13, 14 x 15, 17 x 19, 21 x 22mm  
5/16" x 3/8", 7/16" x 1/2", 9/16" x 5/8", 11/16" x 3/4", 13/16" x 7/8 "
- 10 S-shape double-ring spanners:  
10 x 11, 12 x 13, 14 x 15, 16 x 17, 18 x 19mm  
3/8" x 13/32", 7/16" x 1/2", 9/16" x 19/32", 5/8" x 11/16", 11/16" x 3/4 "
- 10 extra-short combination spanners:  
10, 12, 13, 14, 17 mm  
3/8", 7/16", 1/2", 9/16", 5/8 "



**Inches + metric**

Description	Part no.
50-piece	00935L

## S-type double-ring spanner set, Double hexagon

Chrome-vanadium, chrome-plated, ideal for spots that are difficult to access, in roll-up bag.



Description	Part no.
5-piece, 10x11, 12x13, 14x15, 16x17, 18x19 mm	01905L

## Crescent spanner set, Double hexagon

- twelve-edge design for better grip
- chrome-vanadium plated
- packed in a practical roll bag



Description	Part no.
3-piece 10x13, 14x15, 17x19 mm	01910L

## Open ring spanners

on clamping rail, ideal for injection lines, air-conditioning systems, brake lines, compressed air and hydraulic lines, power steering 10 mm (3/8") drive.



Description	Part no.
10-piece, 10-11-12-13-14-15-16-17-18-19 mm	01480L

## Open-ended ring spanner



ideal for injection lines, air conditioning systems, brake lines, compressed air and hydraulic lines and the power steering 10 mm (3/8") drive.



Size	Part no.
10 mm	01480L-10
11 mm	01480L-11
12 mm	01480L-12
13 mm	01480L-13
14 mm	01480L-14
15 mm	01480L-15
16 mm	01480L-16
17 mm	01480L-17
18 mm	01480L-18
19 mm	01480L-19

## Open ring spanners



on clamping rail, ideal for injection lines, air-conditioning systems, brake lines, compressed air and hydraulic lines, oil pressure switches, 12,5 mm (1/2") drive

- 20, 21, 22, 23, 24, 25, 26, 27, 28, 30, 32 mm
- extention 125 mm
- breaker bar 385 mm

MAN LKW  
Mercedes-Benz LKW



Description	Part no.
13-piece	01490L
empty case	01490L-KOFFER

## Open ring spanner

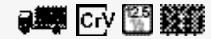

ideal for injection lines, air-conditioning systems, brake lines, compressed air and hydraulic lines, oil pressure switches, 12,5 mm (1/2") drive



Size	Part no.
20 mm	01490L-20
21 mm	01490L-21
22 mm	01490L-22
23 mm	01490L-23
24 mm	01490L-24
25 mm	01490L-25
26 mm	01490L-26
27 mm	01490L-27
28 mm	01490L-28
30 mm	01490L-30
32 mm	01490L-32

## Open ring spanner



e.g. for compressed air and hydraulic lines, 12,5 mm (1/2") drive.



Size	Part no.
33 mm	01495L-33
38 mm	01495L-38
41 mm	01495L-41
46 mm	01495L-46
50 mm	01495L-50



## Adjustable spanner



with plastic soft handle, matt nickle-plated, millimeter scale



Description	Length	Part no.
10"	250 mm	00712L







# SOCKETS / RATCHETS / ACCESSORIES





# SOCKETS / RATCHETS / ACCESSORIES

**34-107**



▶ 6,3 mm (1/4")	36-47
▶ 10 mm (3/8")	48-59
▶ 12,5 mm (1/2")	59-86
▶ 20 mm (3/4")	87-93
▶ 25 mm (1")	94-97
▶ Assortments	98-106





## Professional socket set



6,3 mm (1/4") drive, chrome-vanadium steel, sockets with hexagon for maximum torque

- lever change-over ratchet with quick-release, 72 teeth
- handle with 6,3 mm (1/4") drive and output
- sockets 4-4.5-5-5.5-6-7-8-9-10-11-12-13 mm
- PH 1-2-3 + slot 4-5.5-6
- T-profile with hole T10-15-20-25-30-40
- hexagon socket 3-4-5-6-7-8 mm
- E-profile E4-5-6-7-8-10-11
- universal joint,
- 2 extensions
- sliding handle
- hexagon socket 1.5-2-2.5 mm



Description	Part no.
47-piece	06447L
Empty case	06447L-KOFFER

## Industrial socket spanner set



6,3 mm (1/4") drive, chrome-vanadium steel, sockets in wave profile for maximum torque.

- Lever-type reversible ratchet wrench with quick-release feature for sockets 72 teeth
- Handle with 6,3 mm (1/4") drive and output
- Wave-profile sockets 4-4.5-5-5.5-6-7-8-9-10-11-12-13-14
- Deep sockets 8-10-12-13
- T-profile without hole T10-15-20-25-30-40
- PH + PZ 1-2-3
- Plain slot 4-5.5-6.5
- Inbus 3-4-5-6-7-8 mm
- Cardan joint + 2 extensions, sliding handle
- Inner hex Allen key 1.5-2-2.5 mm



Description	Part no.
47-piece	06455L

## Industrial socket spanner set



Torque and hardness according to DIN, 6,3 mm (1/4") drive, chrome-vanadium steel, hexagon sockets for maximum torque

- ratchet wrench, fine-toothed with 72 teeth with socket release feature
- hexagon sockets 4 - 14 mm
- cross slot bits PH 1-2-3, PZ 1-2-3
- plain slot bits 4-7 mm
- T-profile bits without tamperproof feature T10-T40
- inner hexagon sockets 3-8 mm
- flexible shaft
- extensions 50-100 mm
- cardan joint
- handle with 6.3 mm (1/4") drive
- sliding handle
- allen keys 1,2-2,5 mm



Description	Part no.
46-piece	S2146

## Professional socket set



6.3 mm (1/4") drive, chrome-vanadium, hexagon sockets for maximum torque

- lever changeover ratchet with quick release
- handle with 6.3 mm (1/4 ") drive and output
- sockets 3.5-4-4.5-5-5.5-6-7-8-9-10-11-12-13-14 mm
- PH + PZ 1 + 2
- slot 4 – 5.5 – 7 mm
- T-profile with bore T10-15-20-25-30-40
- hexagon 3 – 4 – 5 – 6 – 8 mm
- universal joint, 2 extensions, sliding handle
- hexagon socket 1.5-2-2.5 mm



Description	Part no.
41-piece	06450L
Empty case	06450L-KOFFER

## Industrial socket spanner set



Torque and hardness according to DIN, 6.3 mm (1/4") drive, chrome-vanadium, hexagon sockets made for maximum torque

- mini ratchet wrench, fine-toothed with 72 teeth
- PRO TORQUE - socket spanner set 5 - 13 mm
- cross slot bits PH 1-2
- plain slot bits 4.5, 6 mm
- inner hexagon bits 3,4,5 mm
- pozidrive bits PZ 1-2
- T-profile bits, without tamperproof feature T10-T40



Description	Part no.
28-piece	S2143
Empty case	S2143-KOFFER

## Industrial socket spanner set



6,3 mm (1/4") drive, chrome-vanadium steel,

"4-in-1" multi-profile sockets suitable for:

- hexagon & double hexagon screws 4 - 14 mm
- E-profile screws E5 - E18
- Inch sizes from 5/32" - 9/16"

Screwdriver bits:

- Pozidriv PZ1, PZ2
- cross-slot PH1, PH2
- inner hexagon 3, 4, 5, 6, 7, 8 mm
- T-profile with hole T10, 15, 20, 25, 27, 30, 40
- XZN tripe square M4, M5, M6, M8, M10

Set also contains:

- 1 lever-type reversible 72-teeth ratchet wrench with socket release feature
- handle
- 90 mm extension
- cardan joint



Description	Part no.
39-piece	06420L

## Ratchet wrench



ERGO version, chrome-vanadium, with bent shaft to protect from injury, fine-toothed with 72 teeth, with socket locking mechanism



Description	Length	Part no.
Ratchet wrench	145 mm	05790L
Repair set		05790L-REP



## Ratchet wrench

72 6.3 1/4 YYY

ERGO version for minimising the risk of injury, with vinyl body, fine-toothed with 72 teeth, with socket locking mechanism.



① **Approx. 35% lighter than conventional models**

Length  
150 mm

Part no.  
**05799L**

## Reversing ratchet

72 CrV 6.3 1/4 YYY

- chrome-vanadium
- finely toothed with 72 teeth
- insert release pin
- length: 145 mm



Description  
Reversing ratchet  
Repair set

Length  
145 mm

Part no.  
**05795L**  
**05790L-REP**

## Ratchet wrench

72 CrV 6.3 1/4 YYY

fine-toothed with 72 teeth, socket locking mechanism, 2-component handle



① **Extra short**

Length  
108 mm

Part no.  
**05710SB**

## Ratchet wrench

36 6.3 1/4 YYY

with vinyl handle, highly resilient, with socket locking mechanism



Length  
150 mm

Part no.  
**06450-Knarre**

## Ratchet wrench

36 CrV 6.3 1/4 YYY

Chrome-vanadium, with plastic handle and socket locking mechanism



Length  
155 mm

Part no.  
**05700SB**

## Ratchet wrench

36 CrV 6.3 1/4 YYY

Chrome-vanadium, with rubber handle



Length  
140 mm

Part no.  
**05701L**

## Twist grip ratchet

60<sup>z</sup> CrV 6.3 1/4 YYY

Chrome-vanadium, fine-toothed

- the drive square is moved every time the twist grip is turned, making it easier to work in cramped conditions
- through-bolt square makes it suitable for clockwise and anticlockwise
- conventional ratchet work also possible
- with marked direction of rotation
- chrome-plated with ergonomic handle



Length

180 mm

Part no.

05714L

## Ratchet wrench

72<sup>z</sup> CrV 6.3 1/4 YYY

with telescopic extension, can be fixed in 3 positions at 175 – 210 – 240 mm. Fine-toothed with 72 teeth, 5° swivelling angle.



Description

Ratchet wrench

Ratchet wrench repair set

Part no.

05716L

05716L-REP

## Ratchet wrench

72<sup>z</sup> CrV 6.3 1/4 YYY

with 270° rotatable ratchet head. Ideal for working in cramped spaces. Total length only 110 mm.



Length

110 mm

Part no.

05715L

## Ratchet wrench

72<sup>z</sup> CrV 6.3 1/4 YYY

with 220° rotatable ratchet head



Length

155 mm

Part no.

05791L

## Ratchet wrench

72<sup>z</sup> CrV 6.3 1/4 YYY

with joint, chrome-vanadium, chrome-plated, with plastic handle, angle can be fixed in five positions



Length

135 mm

Part no.

05702SB

## Handle

6.3 1/4 YYY

Combination handle 6.3 mm (1/4"), matt chrome-plated



Length

150 mm

Part no.

06450-Handgriff





## T-handle screwdriver



with 1/4" drive

- the freewheeling sleeve handle allows screws and nuts to be screwed in and out quickly
- the knurl ensures a secure grip
- the sleeve handle can be locked into 4 positions, thus enabling the T-handle to be used in each position
- the narrow long shape is ideal for difficult positions and in case of less space
- the long T-handle ensures optimal force transfer



**Length**  
310 mm

**Part no.**  
**02086L**

## Sliding handle



Chrome-vanadium, matt chrome-plated



**Length**  
115 mm

**Part no.**  
**05707L**

## Hinged extension set



chrome-vanadium, matt chrome-plated. Makes mounting angles of about 15° possible without joints being necessary.



**Description**  
3-piece,  
50, 150, 250 mm

**Part no.**  
**05760SB**

## Extension



Chrome-vanadium, matt chrome-plated



**Length**  
50 mm  
75 mm  
150 mm

**Part no.**  
**05704L**  
**05705L**  
**05706L**

## Extension



Chrome-vanadium, with fitted hexagon



**Length**  
50 mm  
100 mm

**Part no.**  
**05712L**  
**05713L**



## Hinged extension

Chrome-vanadium, matt chrome-plated  
makes mounting angle of about 15° possible without joints being necessary

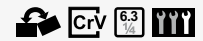

Length	Part no.
50 mm	05752L
100 mm	05753L
150 mm	05754L
250 mm	05755L

## Extension

Chrome-vanadium, chrome-plated, flexible  
for particularly difficult mounting work



① Flexible shank

Length	Part no.
150 mm	05708L
450 mm	05709L

## Cardan joint

Chrome-vanadium, matt chrome-plated



Part no.
05703L

## Adapter

Chrome-vanadium, matt chromed, enlarger socket



Description	Part no.
6.3 mm (1/4") inner to 10 mm (3/8") outer square	07916L

## Adapter

Chrome-vanadium, chrome-plated  
Enlarger socket



Description	Part no.
10 mm (3/8") sockets, 6.3 mm (1/4") ratchet	07904L
12,5 mm (1/2") sockets - 10 mm (3/8") ratchet	07905L
20 mm (3/4") sockets - 12,5 mm (1/2") ratchet	07906L

## IMPACT adapter

Enlargement insert



① Suitable for use with impact wrench

Description	Part no.
10 mm (3/8") sockets - 6,3 mm (1/4") ratchet	07936L





## Spanner socket, Hexagonal

Chrome-vanadium, chrome-plated



① **standard profile**

Size	Length	Part no.
3,5 mm	25 mm	05419L
4 mm	25 mm	05401L
4,5 mm	25 mm	05402L
5 mm	25 mm	05403L
5,5 mm	25 mm	05404L
6 mm	25 mm	05405L
7 mm	25 mm	05406L
8 mm	25 mm	05407L
9 mm	25 mm	05408L
10 mm	25 mm	05409L
11 mm	25 mm	05410L
12 mm	25 mm	05411L
13 mm	25 mm	05412L
14 mm	25 mm	05413L

## Socket spanner set, Hexagonal, Extra deep



Deep spanner sockets, chrome-vanadium, 6.3 mm (1/4") drive, in box

Spanner size 4 - 5 - 5.5 - 6 - 7 - 8 - 9 - 10 - 11 - 12 - 13 mm



Description	Part no.
11-piece	05430L

## Spanner socket, Hexagonal, Extra deep



Chrome-vanadium, chrome-plated



① **Standard profile**

Size	Length	Part no.
4 mm	50 mm	05430-4,0
4,5 mm	50 mm	05430-4,5
5 mm	50 mm	05430-5,0
5,5 mm	50 mm	05430-5,5
6 mm	50 mm	05430-6,0
7 mm	50 mm	05430-7,0
8 mm	50 mm	05430-8,0
9 mm	50 mm	05430-9,0
10 mm	50 mm	05430-10,0
11 mm	50 mm	05430-11,0
12 mm	50 mm	05430-12,0
13 mm	50 mm	05430-13,0
14 mm	50 mm	05430-14,0

## Jointed sockets, Double hexagon



Jointed sockets in double-hexagon version for spots that are difficult to access e.g. on gearboxes and clutch, chrome-vanadium, chrome-plated, on clamping rail, 6.3 mm (1/4") drive

• 5 - 5.5 - 6 - 7 - 8 - 9 - 10 - 11 - 12 - 13 mm



Description	Part no.
10-piece	06620L

## Spanner socket, Wave profile

Chrome-vanadium, chrome-plated



### ① Wave profile

Size	Length	Part no.
4 mm	26 mm	06455L-E4
4,5 mm	26 mm	06455L-E4,5
5 mm	26 mm	06455L-E5
5,5 mm	26 mm	06455L-E5,5
6 mm	26 mm	06455L-E6
7 mm	26 mm	06455L-E7
8 mm	26 mm	06455L-E8
9 mm	26 mm	06455L-E9
10 mm	26 mm	06455L-E10
11 mm	26 mm	06455L-E11
12 mm	26 mm	06455L-E12
13 mm	26 mm	06455L-E13
14 mm	26 mm	06455L-E14

## Screwdriver bits, E Profile

Chrome-vanadium on clamping rail  
6.3 mm (1/4") + 10 mm (3/8") drive

- 6.3 mm (1/4"): E6 - E7 - E8
- 10 mm (3/8"): E10 - E12 - E14 - E16



Description	Part no.
7-piece	04430L

## Spanner socket, E Profile

Chrome-vanadium, chrome-plated



Size	Length	Part no.
E 4	25 mm	05464L
E 5	25 mm	05465L
E 6	25 mm	05460L
E 7	25 mm	05461L
E 8	25 mm	05462L
E 10	25 mm	05466L
E 11	25 mm	05467L

## Socket spanner set, Outer multi-profile "4 in 1"

chrome-vanadium, 6.3 mm (1/4") drive on clamping rail, 4 - 14 mm for loosening hexagon and double-hexagon, E-profile and inch screws.



Description	Part no.
14-piece	05440L



## Socket spanner bit, Outer multi-profile "4 in 1"



Multi-profile '4-in-1', 6.3 mm (1/4") drive, chrome-vanadium, to release hex, double-hex, E-profile and inch-thread bolts



Size	Length	Part no.
4 mm	25 mm	05440L-4
4,5 mm	25 mm	05440L-4,5
5 mm	25 mm	05440L-5
6 mm	25 mm	05440L-6
5,5 mm	25 mm	05440L-5,5
7 mm	25 mm	05440L-7
8 mm	25 mm	05440L-8
9 mm	25 mm	05440L-9
10 mm	25 mm	05440L-10
11 mm	25 mm	05440L-11
12 mm	25 mm	05440L-12
13 mm	25 mm	05440L-13
14 mm	25 mm	05440L-14

## Screwdriver bit, Slot

chrome-vanadium



Profile	Size	Part no.
	4 mm	SE/4-4
	5,5 mm	SE/4-5
	6,5 mm	SE/4-6,5
	7 mm	SE/4-7

## Screwdriver bit, Cross

Chrome-vanadium



Profile	Size	Part no.
	PH 0	KE/4-0
	PH 1	KE/4-1
	PH 2	KE/4-2
	PH 3	KE/4-3

## Screwdriver bit, Pozidrive

Chrome-vanadium



Profile	Size	Part no.
	PZ 0	PE/4-0
	PZ 1	PE/4-1
	PZ 2	PE/4-2
	PZ 3	PE/4-3

## Screwdriver bit, Hexagonal socket

Chrome-vanadium



Profile	Size	Part no.
○	3 mm	IE/4-3
○	4 mm	IE/4-4
○	5 mm	IE/4-5
○	6 mm	IE/4-6
○	7 mm	IE/4-7
○	8 mm	IE/4-8

## Screwdriver bit, T profile without hole

without hole at the end, chrome-vanadium



Profile	Size	Part no.
⊕	T 7	TEO/4-T7
⊕	T 8	TEO/4-T8
⊕	T 9	TEO/4-T9
⊕	T 10	TEO/4-T10
⊕	T 15	TEO/4-T15
⊕	T 20	TEO/4-T20
⊕	T 25	TEO/4-T25
⊕	T 27	TEO/4-T27
⊕	T 30	TEO/4-T30
⊕	T 35	TEO/4-T35
⊕	T 40	TEO/4-T40

## Socket spanner set, T profile without hole

for spots that are difficult to access e.g. on gearboxes, body and the interior (controls and instruments), 6.3 mm (1/4") drive, S2 steel, high-sheen chrome-plated.

- T-profile jointed sockets T8-10-15-20-25-27-30-40
- Hexagon socket bits 3-4-5-6-7
- Bits PH 1-2-3
- Bit holder for 6.3 mm (1/4") bits
- Sliding handle 115 mm



Description	Part no.
18-piece	04462L



## Universal socket, T profile without hole

6.3 mm (1/4") drive, S2 steel, high-gloss chromium-plated

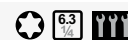

Profile	D	Part no.
	T 8	04462-T8
	T 10	04462-T10
	T 15	04462-T15
	T 20	04462-T20
	T 25	04462-T25
	T 27	04462-T27
	T 30	04462-T30
	T 40	04462-T40

## Screwdriver bits sockets with ball head, T profile without hole

6.3 mm (1/4") drive, 130 mm long, for spots that are difficult to reach, in box with moulded insert.

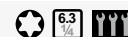

### Description

7-piece,  
T10 - 15 - 20 - 25 - 27 - 30 - 40

### Part no.

05450L

## Sockets with ball head, T profile without hole

6.3 mm (1/4") drive, 130 mm long, for spots that are difficult to reach



Profile	D	Part no.
	T 10	05451L
	T 15	05452L
	T 20	05453L
	T 25	05454L
	T 27	05455L
	T 30	05456L
	T 40	05457L

## Screwdriver bit, T profile with hole

tamperproof, chrome-vanadium

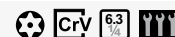

Profile	D	Part no.
	T 8	TEM/4-T8
	T 9	TEM/4-T9
	T 10	TEM/4-T10
	T 15	TEM/4-T15
	T 20	TEM/4-T20
	T 25	TEM/4-T25
	T 27	TEM/4-T27
	T 30	TEM/4-T30
	T 40	TEM/4-T40

## 5-star screwdriver bits sockets, 5 Star with hole



9-piece set, with hole at the end, chrome-vanadium, for VAG, Ford, Volvo, Mercedes-Benz, passenger cars and trucks, Rover etc.

- generator
  - engine control
  - air flow meter
  - door panelling
  - immobiliser
  - unit pumps
- T10 - T15 - T20 - T25 - T27 - T30 - T40 - T45 - T50



**Audi**  
**Ford**  
**Mercedes-Benz**  
**Mercedes-Benz LKW**  
**Rover**  
**Seat**  
**Škoda**  
**VW**  
**Volvo**  
**Volvo LKW**



Description	Profile	Part no.
9-piece		IP/4-SET

## Screwdriver bit, 5 Star with hole



with hole at the end, chrome-vanadium  
 For generator, engine control, air flow meter, door panelling in VAG, Ford, Volvo, Daimler-Benz as well as unit pumps on agricultural machines and Daimler-Benz Actros



**Audi**  
**Ford**  
**Mercedes-Benz**  
**Mercedes-Benz LKW**  
**Seat**  
**Škoda**  
**VW**  
**Rover**

Profile	D	Part no.
	IP 10	IP/4-T10
	IP 15	IP/4-T15
	IP 20	IP/4-T20
	IP 25	IP/4-T25
	IP 27	IP/4-T27
	IP 30	IP/4-T30
	IP 40	IP/4-T40
	IP 45	IP/4-T45
	IP 50	IP/4-T50

## Clamping rail



for 15 sockets with 6.3 mm (1/4") drive



Length	Part no.
412 mm	05400-LEISTE



## Industrial socket spanner set



torque and hardness according to DIN, 10 mm (3/8") drive, chrome-vanadium, sockets with wave profile for maximum torque

- lever-type reversible ratchet wrench, 72 teeth fine-toothed
- bits: T15-T20-T25-T27-T30-T40-T45 -T50-T55
- cross-slot PH 1-3, POZI PZ 1-3
- plain slot 5.5 -7-8 mm, hexagon bit 3-7, 8, 10 mm
- 18 hexagon sockets  
6-7-8-9-10-11-12-13-14-15-16-17-18-19-20-21-22-24 mm
- 10 deep hexagon sockets wave profile  
8-9-10-11-12-13-14-15-17-19 mm
- 2 spark plug sockets 21 + 16 mm
- 1 cardan joint 10 mm (3/8") with spring
- 1 sliding handle / extension 250 mm
- 1 hinged extension 75 mm
- 1 adapter 10 mm (3/8") outer square x 8 mm, outer hex



**Description**  
61-piece  
Empty case

**Part no.**  
**S2229**  
**S2229-KOFFER**

## Industrial socket spanner set



10 mm (3/8") drive, chrome-vanadium steel, hexagon sockets for maximum torque

- Lever-type reversible ratchet wrench with quick-release feature for sockets
- Hexagon sockets 6-7-8-9-10-11-12-13-15-17-19-22-24
- Spark plug sockets size 16 + 21
- T-profile, tamperproof T15-20-25-27-30-40
- Inner hexagon 5 – 6 – 7 – 8 – 10
- XZN 8 – 10 – 12
- 2 extensions
- Cardan joint
- Sliding handle



**Description**  
34-piece

**Part no.**  
**06520L**

## Industrial socket spanner set



Chrome-vanadium steel, wave profile sockets for maximum torque

- Lever-type reversible ratchet wrench with quick-release feature for sockets
- Wave profile sockets 6-7-8-9-10-11-12-13-14-15-16-17-18-19-20-21-22-24 mm
- 3 extensions 45, 75, 150 mm
- Sliding handle
- Spark plug sockets size 16 + 21 mm
- Cardan joint



**Description**  
26-piece  
Empty case

**Part no.**  
**06521L**  
**06521L-KOFFER**



## Industrial socket spanner set, Hexagonal



10 mm (3/8") drive, chrome-vanadium, hardness and torque according to DIN, sockets in hexagonal design for maximum torque.

Harley Davidson



- T-profile bits without tamperproof feature: T15-T20-T25-T27-T30-T40-T45-T50-T55
- cross PH 1-3, pozidrive PZ 1-3
- plain slot bits from 7/32" to 5/16"
- bits for inner hex screws from 1/8" - 3/8"
- hex sockets 1/4" - 15/16"
- 10 deep hex sockets 5/16" - 3/4"
- 2 spark-plug sockets 5/8" + 13/16" = 16 + 21 mm
- 1 cardan joint 10 mm (3/8") with spring
- 1 sliding handle / extension 250 mm
- 1 hinged extension 75 mm
- 1 lever-type reversible ratchet wrench 72 teeth fine-toothed
- 1 adapter 10 mm (3/8") outer square x 8 mm outer hex



Description	Profile	Part no.
61-piece	●	S2171

## Industrial screwdriver set



Chrome-vanadium, bit inserts firmly pressed with the socket

- screwdriver bits T10 - 15 - 20 - 25 - 27 - 30 - 40 - 45 - 50 - 55 - 60
- spanner sockets E4 - 6 - 8 - 10 - 12 - 14 - 16 - 18 - 20
- bits T10 - 15 - 20 - 25 - 27 - 30 - 40 - 50 - 55 x 8 mm
- 1 bit adapter



Description	Part no.
34-piece	04187L

## Ratchet wrench



ERGO version, chrome-vanadium, with bent shaft to protect from injury, fine-toothed with 72 teeth, with socket locking mechanism



Description	Length	Part no.
Ratchet wrench	206 mm	05890L
Repair set		05890L-REP



## Ratchet wrench



ERGO version, chrome-vanadium, with bent shaft to protect from injury, fine-toothed with 72 teeth, with socket locking mechanism



① approx. 35% lighter than conventional models

Length  
197 mm

Part no.  
**05899L**

## Reversing ratchet



- chrome-vanadium
- finely toothed with 72 teeth
- insert release pin
- length: 197 mm



Length  
197 mm

Part no.  
**05895L**

## Reversing ratchet



Chrome-vanadium, with rubber handle and socket locking mechanism



Length  
215 mm

Part no.  
**05800SB**

## Reversing ratchet



with joint, chrome-vanadium, chrome-plated, with plastic handle, angle can be fixed in five positions



Length  
240 mm

Part no.  
**05802L**

## Reversing ratchet



with ca. 220° rotatable ratchet head



Length  
240 mm

Part no.  
**05891L**

## Sliding handle

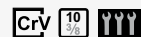

Chrome-vanadium, matt chrome-plated



Length  
202 mm

Part no.  
**S2229-Gleit**

## Extension set



Chrome-vanadium, chrome-plated, for covering large distances

- 375 + 450 + 600 mm



① Extra long

Description	Part no.
3-piece	05820L

## Extension

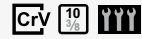

Chrome-vanadium, chrome-plated, with additional hexagon



Length	Part no.
45 mm	05804L
75 mm	05806L
150 mm	05805L

## Hinged extension

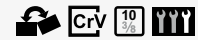

Chrome-vanadium, chrome-plated

makes mounting angle of about 15° possible without joints being necessary



Length	Part no.
75 mm	05851L
125 mm	05856L
150 mm	05852L
250 mm	05853L
450 mm	05855L

## Cardan joint



Chrome-vanadium, matt chrome-plated



Part no.
05803L

## IMPACT ball joint



Chrome-molybdenum, suitable for use with impact wrench, 3/8" drive, with groove and bore, with safety pin and rubber rings. The ball joint prevents blocking during use, as can happen with conventional cardan joints. Can be fixed rigidly for loosening and tightening.



Part no.
07812L

## Adapter

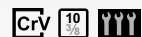

Chrome-vanadium, matt chromed, enlarger socket



Description	Part no.
10 mm (3/8") inner to 12,5 mm (1/2") outer square	07917L





## Adapter



Chrome-vanadium, chrome-plated  
Reducer socket



Description	Part no.
6,3 mm (1/4") sockets - 10 mm (3/8") ratchet	07901L
10 mm (3/8") sockets - 12,5 mm (1/2") ratchet	07902L
12,5 mm (1/2") sockets - 20 mm (3/4") ratchet	07903L

## Adapter



Chrome-vanadium, chrome-plated  
Enlarger socket



Description	Part no.
12,5 mm (1/2") sockets - 10 mm (3/8") ratchet	07905L

## IMPACT adapter



Reduction insert



① Suitable for use with impact wrench

Description	Part no.
6,3 mm (1/4") sockets - 10 mm (3/8") ratchet	07931L

## IMPACT adapter

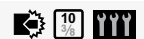

Enlargement insert



① Suitable for use with impact wrench

Description	Part no.
12,5 mm (1/2") sockets - 10 mm (3/8") ratchet	07939L

## Spanner socket, Hexagonal

Chrome-vanadium, chrome-plated



ⓘ Wave profile

Size	Length	Part no.
6 mm	28 mm	05501L
7 mm	28 mm	05502L
8 mm	28 mm	05503L
9 mm	28 mm	05504L
10 mm	28 mm	05505L
11 mm	28 mm	05506L
12 mm	28 mm	05507L
13 mm	28 mm	05508L
14 mm	28 mm	05509L
15 mm	28 mm	05510L
16 mm	28 mm	05511L
17 mm	30 mm	05512L
18 mm	30 mm	05516L
19 mm	30 mm	05513L
20 mm	30 mm	05514L
22 mm	30 mm	05517L
24 mm	30 mm	05515L

## Jointed sockets, Hexagonal

in hexagon version for spots that are difficult to access e.g. at gearbox, car body and interior (auxiliary equipment), chrome-vanadium, chrome-plated, on clamping rail, 10 mm (3/8") drive

- 10, 11, 12, 13, 14, 15, 16, 17, 18, 19 mm



Description	Part no.
10-piece	06600L

## Jointed socket, Hexagonal

Jointed socket in hexagon version for spots that are difficult to reach, chrome-vanadium, chrome-plated, 10 mm (3/8") drive



Size	Part no.
10 mm	06601L
11 mm	06602L
12 mm	06603L
13 mm	06604L
14 mm	06605L
15 mm	06606L
16 mm	06609L
17 mm	06607L
18 mm	06611L
19 mm	06608L





## Socket spanner set, Hexagonal, Extra deep



Deep spanner sockets, chrome-vanadium, 10 mm (3/8") drive, in box

- Spanner size 8 - 10 - 11 - 12 - 13 - 14 - 15 - 16 - 17 - 18 - 19



Description

11-piece

Part no.

05530L

## Spanner socket, Hexagonal, Extra deep



Chrome-vanadium, chrome-plated



Size

Length

Part no.

8 mm

64 mm

05530-8

9 mm

64 mm

05530-9

10 mm

64 mm

05530-10

11 mm

64 mm

05530-11

12 mm

64 mm

05530-12

13 mm

64 mm

05530-13

14 mm

64 mm

05530-14

15 mm

64 mm

05530-15

16 mm

64 mm

05530-16

17 mm

64 mm

05530-17

18 mm

64 mm

05530-18

19 mm

64 mm

05530-19

## Special insert, Hexagonal



10 mm (3/8") drive, thin head and extra slim, also suitable for machine operation.



Profile

Size

Length

Part no.



8 mm

110 mm

05531L



10 mm

110 mm

05532L



13 mm

110 mm

05533L

## Screwdriver bits, E Profile

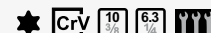

Chrome-vanadium on clamping rail  
6.3 mm (1/4") + 10 mm (3/8") drive

- 6.3 mm (1/4"): E6 - E7 - E8
- 10 mm (3/8"): E10 - E12 - E14 - E16



Description

7-piece

Part no.

04430L

## Spanner socket, E Profile

Chrome-vanadium, chrome-plated



Size	Length	Part no.
E 10	29 mm	05560L
E 11	29 mm	05561L
E 12	29 mm	05562L
E 14	29 mm	05563L
E 16	29 mm	05564L
E 18	29 mm	05565L

## Jointed sockets, E Profile

for spots that are difficult to access, e.g. on gears and clutch, chrome-vanadium, on clamping rail, 10 mm (3/8") drive

- E6, E8, E10, E12, E14



Description	Part no.
5-piece	04461L

## Multi-socket spanner bit, Hexagonal

Chrome-vanadium, chromium-plated, fits all hex nuts and inch sizes



Description	Part no.
9 - 22 mm	05550L

## Special bits

Chrome-vanadium, hardened, matt chrome-plated

- slotted bits in 10, 11, 12, 14, 17 and 19 mm
- for fitting temperature sensors, thermal switches and other components with cables at the top and at the side
- also suitable for screw connections for angled pipes
- the slot width is: 7.4 mm - 8.5 mm - 9.1 mm - 10.5 mm - 13 mm and 14.4 mm
- incl. metal rail



Description	Part no.
6-piece	01482L

## Open ring spanners

on clamping rail, ideal for injection lines, air-conditioning systems, brake lines, compressed air and hydraulic lines, power steering 10 mm (3/8") drive.



Description	Part no.
10-piece, 10-11-12-13-14-15-16-17-18-19 mm	01480L



## Open-ended ring spanner



ideal for injection lines, air conditioning systems, brake lines, compressed air and hydraulic lines and the power steering 10 mm (3/8") drive.

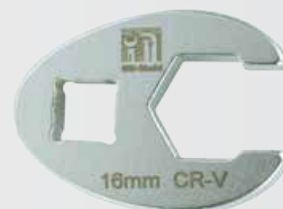

Size	Part no.
10 mm	01480L-10
11 mm	01480L-11
12 mm	01480L-12
13 mm	01480L-13
14 mm	01480L-14
15 mm	01480L-15
16 mm	01480L-16
17 mm	01480L-17
18 mm	01480L-18
19 mm	01480L-19

## Screwdriver bit, Slot



Chrome-vanadium



Profile	Size	Length	Part no.
⦿	5,5 mm	48 mm	S2229-SE5,5
⦿	7 mm	48 mm	S2229-SE7
⦿	8 mm	48 mm	S2229-SE8

## Screwdriver bit, Cross



Chrome-vanadium



Profile	Size	Length	Part no.
⊕	PH 1	48 mm	S2229-PH1
⊕	PH 2	48 mm	S2229-PH2
⊕	PH 3	48 mm	S2229-PH3

## Screwdriver bit, Pozidrive



Chrome-vanadium



Profile	Size	Length	Part no.
⊕	PZ 1	48 mm	S2229-PZ1
⊕	PZ 2	48 mm	S2229-PZ2
⊕	PZ 3	48 mm	S2229-PZ3



## Screwdriver bit, Hexagonal socket



Chrome-vanadium



Profile	Size	Length	Part no.
○	3 mm	48 mm	06520-INB3
○	4 mm	48 mm	06520-INB4
○	5 mm	48 mm	06520-INB5
○	6 mm	48 mm	06520-INB6
○	7 mm	48 mm	06520-INB7
○	8 mm	48 mm	06520-INB8
○	10 mm	48 mm	06520-INB10

## Screwdriver bits, Hexagonal socket



Chrome-vanadium on clamping rail  
10 mm (3/8") drive, inner hexagonal profile, corded

- 1/8", 5/32", 3/16", 7/32", 1/4", 5/16", 3/8"

Inch sizes for installation work on British vehicles, classic cars and US motorbikes



Aston Martin  
Austin Morris  
Austin Rover  
Bentley  
Jaguar  
Oldsmobile  
Plymouth  
Rolls Royce  
Rover

Description	Part no.
7-piece	04922L

## Screwdriver bit, Hexagonal socket



with ball head for spots that are difficult to reach



Profile	Size	Length	Part no.
○	3 mm	53 mm	05570L
○	4 mm	53 mm	05571L
○	5 mm	53 mm	05572L
○	5,5 mm	53 mm	05573L
○	6 mm	53 mm	05574L
○	7 mm	53 mm	05576L
○	8 mm	53 mm	05575L

## IMPACT ball joint bit, Spline



especially for screwing work in spots that are difficult to reach on the drive shafts of many vehicles



Audi  
Seat  
Škoda  
VW

Profile	Size	Length	Part no.
○	M8	130 mm	05215L
○	M10	130 mm	05216L

## Screwdriver bit, Spline

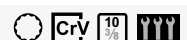

Chrome-vanadium



Profile	Size	Length	Part no.
○	M 8	90 mm	06520-XZN8
○	M 10	90 mm	06520-XZN10
○	M 12	90 mm	06520-XZN12



## Screwdriver bit, T profile without hole



without hole at the end, chrome-vanadium



Profile	Size	Length	Part no.
	T 15	48 mm	S2229-T15
	T 20	48 mm	S2229-T20
	T 25	48 mm	S2229-T25
	T 27	48 mm	S2229-T27
	T 30	48 mm	S2229-T30
	T 40	48 mm	S2229-T40
	T 45	48 mm	S2229-T45
	T 50	48 mm	S2229-T50
	T 55	48 mm	S2229-T55

## Screwdriver bit, T profile with hole



with hole at the end, chrome-vanadium



Profile	Size	Length	Part no.
	T 15	48 mm	06520-T15
	T 20	48 mm	06520-T20
	T 25	48 mm	06520-T25
	T 27	48 mm	06520-T27
	T 30	48 mm	06520-T30
	T 40	48 mm	06520-T40

## Helical groove inserts, Spiral groove

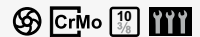

to release badly damaged nuts and bolts. The high-alloy special steel, combined with the aggressive groove profile, loosens all bolts.

10 mm (3/8") drive and additional external hex



Description	Part no.
11-piece, 8-10-11-12-13-14-15-16-17-19 mm	05555L

## Helical groove insert, Spiral groove

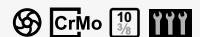

to release badly damaged nuts and bolts. The high-alloy special steel, combined with the aggressive groove profile, loosens all bolts.

10 mm (3/8") drive and additional external hex



Size	Part no.
8 mm	05555L-8
10 mm	05555L-10
11 mm	05555L-11
12 mm	05555L-12
13 mm	05555L-13
14 mm	05555L-14
15 mm	05555L-15
16 mm	05555L-16
17 mm	05555L-17
19 mm	05555L-19

## Clamping rail

for 15 sockets with 10 mm (3/8") drive



Part no.

**05500-LEISTE**



# 12,5 mm (1/2")

## Industrial socket spanner set



Torque and hardness according to DIN, 12,5 mm (1/2") drive, chrome-vanadium steel, hexagon sockets for maximum torque

- reversible ratchet wrench fine-toothed 72 teeth
- 2 Hinged extensions 125 + 250 mm
- 1 Cardan joint 12,5 mm (1/2")
- 1 Adapter for extension / sliding handle
- 2 Spark plug sockets 16 + 21 mm
- 20 Sockets with hexagon profile, 8 mm - 32 mm



Description

27-piece

Empty case

Part no.

**07624L**

**07624L-KOFFER**

## Industrial socket spanner set



Torque and hardness according to DIN, 12,5 mm (1/2") drive, chrome-vanadium steel, sockets with wave profile for maximum torque

- 1 reversible ratchet wrench, fine-toothed with 72 teeth
- 18 sockets with wave profile - 8, 9, 10, 11, 12, 13, 14, 15, 16, 17, 18, 19, 21, 22, 24, 27, 30, 32 mm
- 2 spark plug sockets 16 + 21 mm
- 2 extensions 125 + 250 mm
- 1 sliding handle 250 mm
- 1 cardan joint



Description

25-piece

Part no.

**07620L**





## Industrial socket spanner set, Hexagonal



Harley Davidson

12.5 mm (1/2") drive, chrome-vanadium, hardness and torque according to DIN, sockets in hexagon design for maximum torque

- lever-type reversible ratchet wrench 72 teeth
- 2 hinged extensions 125 + 250 mm
- 1 adapter for extension/sliding handle
- 2 spark-plug sockets 5/8" + 13/16" = 16 + 21 mm
- 20 hex sockets: 5/16" - 11/32" - 3/8" - 7/16" - 15/32" - 1/2" - 9/16" - 19/32" - 5/8" - 21/32" - 11/16" - 3/4" - 25/32" - 13/16" - 7/8" - 15/16" - 1" - 1 1/16" - 1 3/16" - 1 1/4"



Description

27-piece

Part no.

S21-120

## Industrial screwdriver set



Chrome-vanadium, in plastic box, 12.5 mm (1/2") drive, bit inserts firmly pressed with the socket

- screwdriver bits T20 - 25 - 27 - 30 - 40 - 45 - 50 - 55 - 60 - 70
- spanner sockets E10 - 11 - 12 - 14 - 16 - 18 - 20 - 22 - 24



Description

19-piece

Part no.

04180L

## Special bit assortment



Chrome-vanadium, all sockets in optimum length for the special application purpose:

- cylinder head screws
- drive and jointed shafts
- brake calipers



① The insert can be removed and fits in the drawers of all workshop mobile tool chests

Description	Size	Length	Part no.
8-piece			<b>04900L</b>
12.5 mm (1/2") drive - 7 x 140 mm			<b>04900L-INB7</b>
XZN 8 x 100 mm			<b>04900L-XZN8</b>
Cylinder head as well as jointed and drive shafts for VAG			
XZN 10 x 140 mm	M 10	140 mm	<b>04900L-XZN10</b>
cylinder head VAG, Daimler-Benz, Opel as well as drive shafts for Daimler-Benz			
XZN 12 x 140 mm	M 12	140 mm	<b>04900L-XZN12</b>
cylinder head Daimler-Benz on 6, 8, 12-cylinder engines			
RIBE 10.3 x 120			<b>05250L</b>
Cylinder head VAG from 11/96			
T 70 x 120			<b>04900L-TX70</b>
cylinder head screws Ford, Japanese vehicles			
T55 x 140			<b>04900L-TX55</b>
E 12 x 150			
cylinder head screws BMW from 1990 without removing the camshaft as well as generator adjustment on Opel vehicles			<b>05682L</b>

## Ratchet wrench



ERGO version, chrome-vanadium, with bent shaft to protect from injury, fine-toothed with 72 teeth, with socket locking mechanism



Description	Length	Part no.
Ratchet wrench	255 mm	<b>05990L</b>
Repair set		<b>05990L-REP</b>

## Ratchet wrench



ERGO version, chrome-vanadium, with bent shaft to protect from injury, fine-toothed with 72 teeth, with socket locking mechanism



① approx. 35% lighter than conventional models

Length	Part no.
252 mm	<b>05999L</b>

## Reversing ratchet

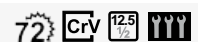

Reversing ratchet

- chrome-vanadium
- finely toothed with 72 teeth
- insert release pin
- length: 267 mm



Length	Part no.
267 mm	<b>05995L</b>





## Ratchet wrench

36<sup>z</sup> CrV 12,5 1/2 YYY

Chrome-vanadium, with plastic handle and socket locking mechanism



Length  
260 mm

Part no.  
05900SB

## Ratchet wrench

36<sup>z</sup> CrV 12,5 1/2 YYY

Chrome-vanadium, with rubber handle



Length  
252 mm

Part no.  
05901L

## Twist grip ratchet

60<sup>z</sup> CrV 12,5 1/2 YYY

Chrome-vanadium, fine-toothed

- the drive square is moved every time the twist grip is turned, making it easier to work in cramped conditions
- the captive through-bolt square makes it suitable for clockwise and anticlockwise use
- conventional ratchet work also possible
- with marked direction of rotation
- chrome-plated with ergonomic handle



Length  
290 mm

Part no.  
05914L

## Telescop ratchet wrench

72<sup>z</sup> CrV 12,5 1/2 YYY

with telescopic extension, chrome-vanadium, can be fixed in 6 positions at 305 - 330 - 360 - 385 - 415 - 445 mm.

Fine-toothed with 72 teeth, 5° swivelling angle.



Description	Part no.
Telescop ratchet wrench	05916L
repair set	05916L-REP

Part no.  
05916L  
05916L-REP

## Ratchet wrench

45<sup>z</sup> CrV 12,5 1/2 YYY

with joint, chrome-vanadium, chrome-plated, with plastic handle, angle can be fixed in five positions



Length  
286 mm

Part no.  
05902SB

## Ratchet wrench

72<sup>z</sup> CrV 12,5 1/2 YYY

with 180° rotatable ratchet head



Length  
310 mm

Part no.  
05991L

## Push-through ratchet

36 CrV 12,5 1/2 YYY

Chrome-vanadium, complete with square drive



Description	Length	Part no.
Komplett-Set	275 mm	05993L
Vierkant		05917L
Ratchet	275 mm	05993L-KNARRE

## Sliding handle

CrV 12,5 1/2 YYY

Chrome-vanadium, matt chrome-plated



Length	Part no.
250 mm	05907L

## Sliding block

CrV 12,5 1/2 YYY

Chrome-vanadium, matt chrome-plated, suitable for extensions with 16 mm diameter



ⓘ with 6.3 mm (3/8") drive on the back site

Length	Part no.
24 mm	05907L-1

## Jointed heavy-duty handle

CrV 12,5 1/2 YYY

Chrome-vanadium, suitable for transferring extremely high torques.



Description	Length	Part no.
Jointed heavy-duty handle	630 mm	05911L
Repair set		05911L-REP

## Power impact driver

12,5 1/2 YYY

Perfect for various applications such as releasing belt pulley retaining bolts, compensation shaft washers, etc.

- enables high loosening torque even in tight spaces
- with double hand-protection insulation



Length	Part no.
620 mm	05919L

## Extension set

CrV 12,5 1/2 YYY

Chrome-vanadium, chrome-plated, for covering large distances



ⓘ Extra long

Description	Part no.
450 + 600 + 750 mm	05920L



## Extension



Chrome-vanadium, matt chrome-plated



Length	Part no.
75 mm	05906L
125 mm	05904L
250 mm	05905L

## Hinged extension set



Chrome-vanadium, chrome-plated  
makes mounting angles of about 15° possible without joints being necessary

- 50 + 125 + 250 mm



Description	Part no.
3-piece	05970SB

## Hinged extension

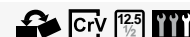

Chrome-vanadium, chrome-plated  
makes mounting angles of about 15° possible without joints being necessary



Length	Part no.
50 mm	05951L
125 mm	05952L
250 mm	05953L
375 mm	05954L
500 mm	05955L

## LED extension



1/2" drive, the integrated LED lamp with on/off switch illuminates installation spots especially brightly



Length	Part no.
60 mm	05912L

## IMPACT extension



Suitable for use with impact wrench



Length	Part no.
75 mm	07806L
125 mm	07807L
250 mm	07808L

## Cardan joint



Chrome-vanadium, matt chrome-plated



Part no.
05903L



## IMPACT cardan joint

Suitable for use with impact wrench  
chrome-molybdenum



Part no.  
**07809L**

## IMPACT ball joint

Chrome-molybdenum steel, suitable for use with impact wrench, 1/2" drive, with groove and bore. The ball joint prevents blocking during use, as can happen with conventional cardan joints.

Can be fixed rigidly for loosening and tightening.



Part no.  
**07811L**

## Adapter

Chrome-vanadium, matt chromed, enlarger socket



Description

12.5 mm (1/2") inner to 20 mm (3/4") outer square

Part no.  
**07918L**

## Adapter

Chrome-vanadium, chrome-plated  
Reducer socket



Description

10 mm (3/8") sockets, 12.5 mm (1/2") ratchet

Part no.  
**07902L**

## Adapter

Chrome-vanadium, chrome-plated  
Enlarger socket



Description

20 mm (3/4") sockets, 12.5 mm (1/2") ratchet

Part no.  
**07906L**

## IMPACT adapter

Reduction insert



ⓘ Suitable for use with impact wrench

Description

10 mm (3/8") sockets - 12,5 mm (1/2") ratchet

Part no.  
**07932L**





## IMPACT Adapter



Enlarger socket



① Suitable for use with impact wrench

Description	Part no.
20 mm (3/4") sockets - 12,5 mm (1/2") ratchet	07933L

## Spanner socket, Hexagonal



Chrome-vanadium, chrome-plated



① Standard profile

Size	Length	Part no.
8 mm	38 mm	05625L
9 mm	39 mm	05626L
10 mm	40 mm	05601L
11 mm	40 mm	05602L
12 mm	38 mm	05603L
13 mm	38 mm	05604L
14 mm	39 mm	05605L
15 mm	40 mm	05606L
16 mm	39 mm	05607L
17 mm	39 mm	05608L
18 mm	39 mm	05609L
19 mm	38 mm	05610L
20 mm	39 mm	05611L
21 mm	38 mm	05612L
22 mm	39 mm	05613L
23 mm	38 mm	05614L
24 mm	38 mm	05615L
25 mm	38 mm	05616L
27 mm	42 mm	05617L
28 mm	44 mm	05618L
30 mm	45 mm	05619L
32 mm	46 mm	05620L
36 mm	51 mm	05621L

## Spanner socket set, Hexagonal



chrome-vanadium, chrome-plated, 12.5 mm (1/2") drive, inch sizes:

- 3/8", 7/16", 1/2", 9/16", 5/8", 11/16", 3/4", 13/16", 7/8", 15/16"



- Austin
- Austin Morris
- Austin Rover
- Buick
- Cadillac
- Cobra
- General Motors
- GMC
- Jaguar
- Land Rover
- MG
- Mini
- Morgan
- Plymouth
- Rolls Royce
- Rover
- Triumph
- TVR
- Harley Davidson

Description	Profile	Part no.
10-piece	●	S21-125

## IMPACT spanner sockets, Hexagonal, Short



suitable for use with impact wrench, with groove and bore hole for ball, 1/2" drive

- 10 - 12 - 13 - 14 - 15 - 17 - 19 - 21 - 22 - 24 mm



① short version

Description	Profile	Part no.
10-piece	●	07950L

## IMPACT spanner socket, Hexagonal, Short



Suitable for use with impact wrench, with groove and bore hole for ball, burnished



Size	Length	Part no.
10 mm	38 mm	07820L
11 mm	38 mm	07821L
12 mm	38 mm	07822L
13 mm	38 mm	07823L
14 mm	38 mm	07824L
15 mm	38 mm	07825L
16 mm	38 mm	07826L
17 mm	38 mm	07827L
18 mm	38 mm	07828L
19 mm	38 mm	07829L
21 mm	38 mm	07835L
22 mm	38 mm	07830L
24 mm	38 mm	07831L
27 mm	40 mm	07832L
30 mm	48 mm	07833L
32 mm	44 mm	07834L

## IMPACT-Duty ball joint sockets, Hexagonal



in hexagon version for spots that are difficult to reach, chrome-molybdenum steel, suitable for use with impact screwdrivers, 12,5 mm (1/2") drive, with groove and bore

- 16, 17, 18, 19 mm



Description	Part no.
4-piece	07955L

## IMPACT-Duty ball joint insert, Hexagonal



in hexagon version for spots that are difficult to reach, chrome-molybdenum steel, suitable for use with impact wrench, 12,5 mm (1/2") drive, with groove and bore



Size	Part no.
16 mm	07951L
17 mm	07952L
18 mm	07953L
19 mm	07954L





## Spanner sockets, Hexagonal, Extra deep



Chrome-vanadium, chrome-plated

- 10 - 12 - 13 - 14 - 15 - 16 - 17 - 19 - 22 - 24 mm



Description	Profile	Part no.
10-piece	●	05630L

## Spanner socket, Hexagonal, Extra deep



Chrome-vanadium, chrome-plated



Size	Length	Part no.
10 mm	78 mm	05630-10
11 mm	78 mm	05630-11
12 mm	78 mm	05630-12
13 mm	78 mm	05630-13
14 mm	78 mm	05630-14
15 mm	78 mm	05630-15
16 mm	78 mm	05630-16
17 mm	78 mm	05630-17
18 mm	78 mm	05630-18
19 mm	78 mm	05630-19
20 mm	78 mm	05630-20
21 mm	78 mm	05630-21
22 mm	78 mm	05630-22
24 mm	78 mm	05630-24

## IMPACT spanner sockets, Hexagonal, Long



10-piece set, suitable for use with impact wrench, with groove and bore hole for ball, 12,5 mm (1/2") drive

- 10 - 12 - 13 - 14 - 15 - 17 - 19 - 21 - 22 - 24 mm



① long version

Description	Profile	Part no.
10-piece	●	07960L
Empty case		07960L-KOFFER

## IMPACT spanner socket, Hexagonal, Long

Suitable for use with impact wrench, with groove and bore hole for ball, chrome-molybdenum, burnished



Size	Length	Part no.
10 mm	78 mm	07840L
11 mm	78 mm	07841L
12 mm	78 mm	07842L
13 mm	78 mm	07843L
14 mm	78 mm	07844L
15 mm	78 mm	07845L
16 mm	78 mm	07846L
17 mm	78 mm	07847L
18 mm	78 mm	07848L
19 mm	78 mm	07849L
21 mm	78 mm	07805L
22 mm	78 mm	07850L
24 mm	78 mm	07851L
27 mm	78 mm	07852L
30 mm	78 mm	07853L
32 mm	78 mm	07854L



## Spanner sockets, Double hexagon

16-piece set, chrome-vanadium, chrome-plated

- 8 - 9 - 10 - 11 - 12 - 13 - 14 - 15 - 16 - 17 - 18 - 19 - 20 - 21 - 22 - 24 mm



Description	Profile	Part no.
16-piece		05640L



## Spanner socket, Double hexagon

Chrome-vanadium, chrome-plated



Size	Length	Part no.
8 mm	38 mm	05640-8
9 mm	38 mm	05640-9
10 mm	38 mm	05640-10
11 mm	38 mm	05640-11
12 mm	38 mm	05640-12
13 mm	38 mm	05640-13
14 mm	38 mm	05640-14
15 mm	38 mm	05640-15
16 mm	38 mm	05640-16
17 mm	38 mm	05640-17
18 mm	38 mm	05640-18
19 mm	38 mm	05640-19
20 mm	38 mm	05640-20
21 mm	38 mm	05640-21
22 mm	38 mm	05640-22
24 mm	38 mm	05640-24
27 mm	43 mm	05640-27
30 mm	45 mm	05640-30
32 mm	45 mm	05640-32
36 mm	51 mm	05640-36





## Spanner sockets, Double hexagon, Extra deep



Chrome-vanadium, chrome-plated

- 10 - 11 - 12 - 13 - 14 - 15 - 16 - 17 - 18 - 19 - 21 - 22 - 24 mm



Description	Profile	Part no.
13-piece		05632L

## Spanner socket, Double hexagon, Extra deep

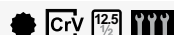

Chrome-vanadium, chrome-plated



Size	Length	Part no.
10 mm	78 mm	05632-10SB
11 mm	78 mm	05632-11SB
12 mm	78 mm	05632-12SB
11 mm	78 mm	05632-13SB
14 mm	78 mm	05632-14SB
15 mm	78 mm	05632-15SB
16 mm	78 mm	05632-16SB
17 mm	78 mm	05632-17SB
18 mm	78 mm	05632-18SB
19 mm	78 mm	05632-19SB
21 mm	78 mm	05632-21SB
22 mm	78 mm	05632-22SB
24 mm	78 mm	05632-24SB

## IMPACT spanner sockets, Double hexagon



high-strength, for loosening the propeller shaft screws on different vehicles, e.g. Audi, BMW, Citroën, Ford, Opel, Mercedes-Benz, Nissan, Škoda, Seat, Renault, VW etc.

comprising:

- 5 extremely deep double-hexagon sockets: 27-30-32-34-36 mm
- 3 Inner hex sockets 14-17-19 mm



- Opel
- Mercedes-Benz
- Ford
- BMW
- Fiat
- Nissan
- Seat
- Škoda
- Audi
- Toyota
- VW
- Citroën
- Renault
- Lancia
- Mercedes-Benz LKW
- Subaru

Description	Part no.
8-piece	10185L

## IMPACT spanner sockets, Double hexagon, Extra deep

high-strength, for loosening the propeller shaft screws on different vehicles, e.g. Audi, BMW, Ford, Opel, Mercedes-Benz, Nissan, Seat, Škoda, Toyota, VW etc.



- VW
- Škoda
- Seat
- Mercedes-Benz
- BMW
- Audi
- Fiat
- Ford
- Nissan
- Opel
- Subaru
- Toyota



Description	Profile	Size	Length	Part no.
3-piece	●	30, 32, 36 mm	78 mm	10190L
Passat 35, Golf VI	●	24 mm	78 mm	10189L
Truckgear G2/24/26, z.B. MB Actros and BMW drive shaft	●	27 mm	78 mm	10194L
VAG, BMW, Mercedes-Benz, Ford, Opel Toyota u.a.	●	30 mm	78 mm	10191L
Fiat, Ford, Mercedes-Benz, Nissan, Opel, Subaru u.a.	●	32 mm	78 mm	10192L
Fiat, Lancia, Renault u.a.	●	34 mm	78 mm	10196L
Fiat, Peugeot	●	35 mm	78 mm	10198L
Double hex	●	36 mm	82 mm	10181L

## Spanner socket, Wave profile

Chrome-vanadium, chrome-plated



### Wave profile

Size	Length	Part no.
8 mm	38 mm	07620L-E8
9 mm	38 mm	07620L-E9
10 mm	44 mm	07620L-E10
11 mm	44 mm	07620L-E11
12 mm	44 mm	07620L-E12
13 mm	44 mm	07620L-E13
14 mm	44 mm	07620L-E14
15 mm	44 mm	07620L-E15
16 mm	44 mm	07620L-E16
17 mm	44 mm	07620L-E17
18 mm	44 mm	07620L-E18
19 mm	44 mm	07620L-E19
20 mm	44 mm	07620L-E20
21 mm	44 mm	07620L-E21
22 mm	44 mm	07620L-E22
24 mm	44 mm	07620L-E24
27 mm	44 mm	07620L-E27
30 mm	44 mm	07620L-E30
32 mm	44 mm	07620L-E32

## Industrial socket spanner set, E Profile

Chrome-vanadium, in plastic box, 12.5 mm (1/2") drive

E-profile:

- E10 - 11 - 12 - 14 - 16 - 18 - 20 - 22 - 24



Description	Part no.
9-piece	04435L



## Spanner socket, E Profile

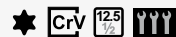

Chrome-vanadium, chrome-plated



Size	Length	Part no.
E10	38 mm	05660L
E11	38 mm	05661L
E12	38 mm	05662L
E14	38 mm	05663L
E16	38 mm	05664L
E18	38 mm	05665L
E20	38 mm	05666L
E22	38 mm	05667L
E24	38 mm	05668L

## Socket inserts, E Profile, Extra long



for E-profile screws, extra thin-walled and 150 mm long,

**BMW**  
**Mercedes-Benz**  
**VW**  
**MAN**  
**Audi**  
**Opel**

- E10 - E12 - E14 - E16 - E18 - E20

E10 e.g. For door hinge bolts on sides and levers of Mercedes-Benz Sprinter and identical LT to '05

E12 e.g. For cylinder head bolts BMW 90 without removing the camshaft as well as adjustment of the engine settings for Vauxhall / Opel vehicles, MAN valve covers

E14 e.g. For drive shafts Mercedes-Benz S-Class, cylinder head Vauxhal / Opel, Audi V6 as Audi 80 with ABS, BMW rear axle bearing unit

E16 e.g. For cylinder head bolts Mercedes-Benz A-Class at 1.4l and 1.7l Diesel

E18 e.g. For the brake caliper fitting on MAN commercial vehicles

E20 e.g. For the cylinder head bolts on MAN commercial vehicles



① E12 is able to remove cylinder head screws in BMW vehicles without removing the camshaft

Description	Profile	Length	Part no.
6-piece, E10-E12-E14-E16-E18-E20	★	150 mm	05685L

## Spanner sockets, E Profile, Extra deep

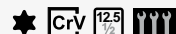

Chrome-vanadium, chrome-plated

- E10 - E11 - E12 - E14 - E16 - E18 - E20 - E22 - E24



Description	Profile	Part no.
9-piece	★	05680L

## Spanner socket, E Profile, Extra deep

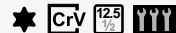

Chrome-vanadium, chrome-plated



Size	Length	Part no.
E10	78 mm	05670L
E11	78 mm	05678L
E12	78 mm	05671L
E14	78 mm	05672L
E16	78 mm	05673L
E18	78 mm	05674L
E20	78 mm	05675L
E22	78 mm	05676L
E24	78 mm	05677L



## IMPACT spanner sockets, E Profile, Long



suitable for use with impact wrench, with groove and bore hole for ball, 12,5 mm ( 1/2") drive

- E10 - 11 - 12 - 14 - 16 - 18 - 20 - 22 - 24



① long version

Description	Profile	Part no.
9-piece	★	S5100

## Spanner sockets, Outer multi-profile "4 in 1"



chrome-vanadium, suitable for E-profile, inch, metric, hexagon & double-hexagon.

- 8 - 9 - 10 - 11 - 12 - 13 - 14 - 15 - 16 - 17 - 18 - 19 - 20 - 21 - 22 - 24 - 27 - 30 - 32 mm



Description	Profile	Part no.
19-piece	Outer multi-profile "4 in 1"	05650L

## Socket spanner bit, Outer multi-profile "4 in 1"



1/2" drive, chrome-vanadium, to release hex, double-hex, E-profile and inch-thread bolts



Size	Length	Part no.
8 mm	25 mm	05650L-8
9 mm	25 mm	05650L-9
10 mm	25 mm	05650L-10
11 mm	25 mm	05650L-11
12 mm	25 mm	05650L-12
13 mm	25 mm	05650L-13
14 mm	25 mm	05650L-14
15 mm	25 mm	05650L-15
16 mm	25 mm	05650L-16
17 mm	25 mm	05650L-17
18 mm	25 mm	05650L-18
19 mm	25 mm	05650L-19
20 mm	25 mm	05650L-20
21 mm	25 mm	05650L-21
22 mm	25 mm	05650L-22
24 mm	25 mm	05650L-24
27 mm	25 mm	05650L-27
30 mm	25 mm	05650L-30
32 mm	25 mm	05650L-32

## Open ring spanners



on clamping rail, ideal for injection lines, air-conditioning systems, brake lines, compressed air and hydraulic lines, oil pressure switches, 12,5 mm (1/2") drive

- 20, 21, 22, 23, 24, 25, 26, 27, 28, 30, 32 mm
- extension 125 mm
- breaker bar 385 mm



MAN LKW  
Mercedes-Benz LKW

Description	Part no.
13-piece	01490L
Empty case	01490L-KOFFER



## Open ring spanner

ideal for injection lines, air-conditioning systems, brake lines, compressed air and hydraulic lines, oil pressure switches, 12,5 mm (1/2") drive

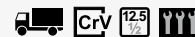
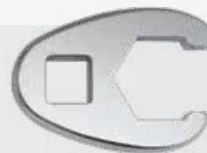

Size	Part no.
20 mm	01490L-20
21 mm	01490L-21
22 mm	01490L-22
23 mm	01490L-23
24 mm	01490L-24
25 mm	01490L-25
26 mm	01490L-26
27 mm	01490L-27
28 mm	01490L-28
30 mm	01490L-30
32 mm	01490L-32

## Screwdriver bits, Hexagonal socket

6-piece set, chrome-vanadium, pressed tightly to the socket, in box with moulded insert

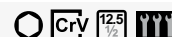

Description	Profile	Part no.
Hexagon profile 6 - 8 - 10 x 53 mm / 7 - 8 - 10 x 100 mm, 6-piece	○	S5117

## Screwdriver bits, Hexagonal socket

Chrome-vanadium, pressed tightly to the socket, in box

- 5 - 6 - 7 - 8 - 10 - 12 - 14 - 16 - 17 - 18 - 19 - 22 mm

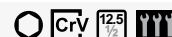

Description	Profile	Part no.
12-piece	○	04950L

## Screwdriver bits, Hexagonal socket

12.5 mm (1/2") drive, chrome-vanadium S2-special steel

- 55 mm long  
5 - 6 - 7 - 8 - 10 - 12 - 14 - 17 - 19 mm
- 100 mm long  
5 - 6 - 7 - 8 - 10 - 11 - 12 - 13 mm
- 140 mm long  
5 - 6 - 7 - 8 - 10 - 12 - 14 mm
- 200 mm long  
5 - 6 - 7 - 8 - 10 - 12 mm

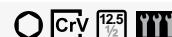

Description	Part no.
30-piece	04923L

## Screwdriver bit, Hexagonal socket, Short



Chrome-vanadium



Profile	Size	Length	Part no.
○	4 mm	53 mm	<b>05101L</b>
○	5 mm	53 mm	<b>05102L</b>
○	6 mm	53 mm	<b>05103L</b>
○	7 mm	53 mm	<b>05104L</b>
○	8 mm	53 mm	<b>05105L</b>
○	10 mm	53 mm	<b>05106L</b>
○	12 mm	53 mm	<b>05107L</b>
○	14 mm	53 mm	<b>05108L</b>
○	17 mm	53 mm	<b>05109L</b>
○	19 mm	53 mm	<b>05110L</b>
○	22 mm	53 mm	<b>05114L</b>
○	24 mm	53 mm	<b>05115L</b>

## Screwdriver bit, Hexagonal socket, Long



Chrome-vanadium



Profile	Size	Length	Part no.
○	4 mm	100 mm	<b>05000L</b>
○	5 mm	100 mm	<b>05001L</b>
○	6 mm	100 mm	<b>05002L</b>
○	7 mm	100 mm	<b>05003L</b>
○	8 mm	100 mm	<b>05004L</b>
○	10 mm	100 mm	<b>05005L</b>
○	11 mm	100 mm	<b>05048L</b>
○	12 mm	100 mm	<b>05006L</b>
○	13 mm	100 mm	<b>05049L</b>

## Screwdriver bit, Hexagonal socket, Long

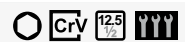

Chrome-vanadium



Profile	Size	Length	Part no.
○	5 mm	140 mm	<b>05012L</b>
○	6 mm	140 mm	<b>05013L</b>
○	7 mm	140 mm	<b>05014L</b>
○	8 mm	140 mm	<b>05015L</b>
○	10 mm	140 mm	<b>05017L</b>
○	12 mm	140 mm	<b>05041L</b>
○	14 mm	140 mm	<b>05007L</b>





## Screwdriver bit, Hexagonal socket, Long

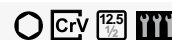

Chrome-vanadium



Profile	Size	Length	Part no.
○	5 mm	200 mm	<b>05042L</b>
○	6 mm	200 mm	<b>05043L</b>
○	7 mm	200 mm	<b>05044L</b>
○	8 mm	200 mm	<b>05045L</b>
○	10 mm	200 mm	<b>05046L</b>
○	12 mm	200 mm	<b>05047L</b>

## Screwdriver bit, Hexagonal socket, Long

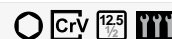

Chrome-vanadium



Description	Profile	Size	Length	Part no.
Brake calliper screws VW etc.	○	7 mm	230 mm	<b>05016L</b>

## Screwdriver bits, Hexagonal socket ball head, Long

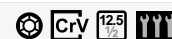

Chrome-vanadium

BMW

- 5 - 6 - 7 - 8 - 10 - 12 mm x 140 mm long



Description	Profile	Part no.
6-piece	⊗	<b>05010L</b>

## Screwdriver bit, Hexagonal socket ball head, Long

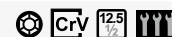

Chrome-vanadium



Profile	Size	Length	Part no.
⊗	4 mm	140 mm	<b>05010L-4</b>
⊗	5 mm	140 mm	<b>05010L-5</b>
⊗	5 mm	160 mm	<b>05011L</b>
⊗	6 mm	140 mm	<b>05010L-6</b>
⊗	7 mm	140 mm	<b>05010L-7</b>
⊗	8 mm	140 mm	<b>05010L-8</b>
⊗	10 mm	140 mm	<b>05010L-10</b>
⊗	12 mm	140 mm	<b>05010L-12</b>

## IMPACT screwdriver bits, Hexagonal socket



Impact screwdriver-ready, with groove and bore for the ball, 12.5 mm (1/2") drive, 75 mm long

- 5 - 6 - 8 - 10 - 12 - 14 - 17 - 19 mm



Description	Profile	Part no.
8-piece	○	<b>S5481</b>

## IMPACT screwdriver bit, Hexagonal socket



Impact screwdriver-ready, with groove and bore for the ball, 12.5 mm (1/2") drive, 75 mm long



Profile	Size	Length	Part no.
○	5 mm	75 mm	S5481-5
○	6 mm	75 mm	S5481-6
○	8 mm	75 mm	S5481-8
○	10 mm	75 mm	S5481-10
○	12 mm	75 mm	S5481-12
○	14 mm	75 mm	S5481-14
○	17 mm	75 mm	S5481-17
○	19 mm	75 mm	S5481-19

## Screwdriver bits, Spline



12.5 mm (1/2") drive, chrome-vanadium S2-special steel

- 55 mm long  
M5 - M6 - M8 - M9 - M10 - M12 - M14 - M16
- 100 mm long  
M5 - M6 - M8 - M9 - M10 - M12 - M14
- 140 mm long  
M5 - M6 - M8 - M9 - M10 - M12 - M14
- 200 mm long  
M8 - M10 - M12 - M14



Description	Part no.
26-piece	04424L

## Screwdriver bit



from set 04424L



Description	Size	Length	Part no.
	5 mm	140 mm	04424L-XZN5
	6 mm	140 mm	04424L-XZN6
	8 mm	140 mm	04424L-XZN8
	9 mm	140 mm	04424L-XZN9
XZN 10 x 140 mm cylinder head VAG, Daimler-Benz, Opel as well as drive shafts for Daimler-Benz	10 mm	140 mm	04900L-XZN10
XZN 12 x 140 mm cylinder head Daimler-Benz on 6, 8, 12-cylinder engines	12 mm	140 mm	04900L-XZN12
	14 mm	140 mm	04424L-XZN14

## XZN tripe square insert



from set 04424L



Size	Length	Part no.
8 mm	200 mm	04424L-XZN8L
10 mm	200 mm	04424L-XZN10L
12 mm	200 mm	04424L-XZN12L
14 mm	200 mm	04424L-XZN14L



## Screwdriver bits

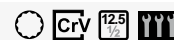

chrome-vanadium, pressed tightly to the socket, in box with moulded insert



Description	Part no.
6-piece, 6 - 8 - 10 x 53 mm / 8 - 10 - 12 x 100 mm	<b>S5106</b>

## Screwdriver bit, Spline, Short

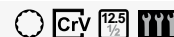

Chrome-vanadium



Profile	Size	Length	Part no.
○	M 5	53 mm	<b>05301L</b>
○	M 6	53 mm	<b>05302L</b>
○	M 8	53 mm	<b>05303L</b>
○	M 10	53 mm	<b>05304L</b>
○	M 12	53 mm	<b>05305L</b>
○	M 14	53 mm	<b>05306L</b>
○	M 16	53 mm	<b>05307L</b>

## Screwdriver bit, XZN tripe square, Spline

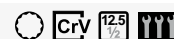

e.g. for cylinder head screws Mercedes-Benz M400, M420, M500 engines  
(cf. OEM 422589010900)

**Mercedes-Benz**



Description	Part no.
XZN tripe square M17 x 60 mm for cylinder head screws MB	<b>05253L</b>

## Screwdriver bit, Spline, Long

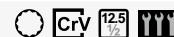

Chrome-vanadium



Description	Profile	Size	Length	Part no.
	○	M 5	100 mm	<b>05200L</b>
	○	M 6	100 mm	<b>05201L</b>
	○	M 8	100 mm	<b>05202L</b>
Cylinder head screws Daihatsu and Toyota	○	M 9	100 mm	<b>05207L</b>
	○	M 10	100 mm	<b>05203L</b>
	○	M 12	100 mm	<b>05204L</b>
	○	M 14	100 mm	<b>05205L</b>
	○	M 14	140 mm	<b>05227L</b>
	○	M 16	100 mm	<b>05228L</b>

## IMPACT screwdriver bits, Spline, Long



made of special steel, 12.5 mm (1/2") drive, suitable for use with impact wrench, XZN tripe square profile

Also ideal e.g. for screws glued into brake callipers or drive shafts, maximum strength



Description	Profile	Part no.
3-piece, M8, M10, M12	○	05213L

## IMPACT screwdriver bit, Spline, Long



made of special steel, 12.5 mm (1/2") drive, suitable for use with impact wrench, XZN tripe square profile

Also ideal e.g. for screws glued into brake callipers or drive shafts, maximum strength



Profile	Size	Length	Part no.
○	M 8	100 mm	05210L
○	M 10	100 mm	05211L
○	M 12	140 mm	05212L
○	M 18	78 mm	05218L

## IMPACT screwdriver bits, Spline



12,5 mm (1/2") drive, XZN tripe square M14, M16, M18 each in 40 + 75 mm length. For installation of the high-strength screws to brake carrier and shock absorber fitting, brake system, drive wheel on the camshaft and rear brake callipers, work on the chassis as well as removal and installation of the wheel bearings/wheel hub unit on the Passat 3C, Touareg and Phaeton, Touran from 2004 and Audi A3 from 2004, Golf V and identical Škoda vehicles



Audi  
Škoda  
VW

Description	Profile	Part no.
6-piece	○	10195L
M14 x 40 mm	○	10195L-14K
M16 x 40 mm	○	10195L-16K
M18 x 40 mm	○	10195L-18K
M14 x 75 mm	○	10195L-14L
M16 x 75 mm	○	10195L-16L
M18 x 75 mm	○	10195L-18L

## IMPACT screwdriver bits, Spline



Impact screwdriver-ready, with groove and bore for the ball, 12.5 mm (1/2") drive, 75 mm long

- M4 - 5 - 6 - 8 - 9 - 10 - 12 - 14 - 16



Description	Profile	Part no.
9-piece	○	S5482



## IMPACT screwdriver bit, Spline



Impact screwdriver-ready, with groove and bore for the ball, 12.5 mm (1/2") drive, 75 mm long



Profile	Size	Length	Part no.
○	M 4	75 mm	<b>S5482-4</b>
○	M 5	75 mm	<b>S5482-5</b>
○	M 6	75 mm	<b>S5482-6</b>
○	M 8	75 mm	<b>S5482-8</b>
○	M 9	75 mm	<b>S5482-9</b>
○	M 10	75 mm	<b>S5482-10</b>
○	M 12	75 mm	<b>S5482-12</b>
○	M 14	75 mm	<b>S5482-14</b>
○	M 16	75 mm	<b>S5482-16</b>

## Screwdriver bits, RB profile



12.5 mm (1/2") drive, chrome-vanadium S2-special steel

- 55 and 100 mm long  
M5 - M6 - M7 - M8 - M9 - M10 - M12 - M13 - M14
- 140 and 200 mm long  
M8 - M9 - M10 - M10.3 - M12 - M13 - M14



Description	Part no.
32-piece	<b>04422L</b>

## Screwdriver bit, RB-profile



Chrome-vanadium, e.g. head lamp, valve cover and spark plug cover.



Profile	Size	Length	Part no.
⊗	M 5	55 mm	<b>04561L</b>
⊗	M 6	55 mm	<b>04533L</b>
⊗	M 7	55 mm	<b>04534L</b>
⊗	M 8	55 mm	<b>04535L</b>
⊗	M 9	55 mm	<b>04536L</b>
⊗	M 10	55 mm	<b>04537L</b>
⊗	M 12	55 mm	<b>04562L</b>
⊗	M 13	55 mm	<b>04563L</b>
⊗	M 14	55 mm	<b>04564L</b>



## Screwdriver bit, RB-profile

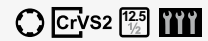

Chrome-vanadium, e.g. head lamp, valve cover and spark plug cover.



Profile	Size	Length	Part no.
	M 5	100 mm	04565L
	M 6	100 mm	04538L
	M 7	100 mm	04539L
	M 8	100 mm	04540L
	M 9	100 mm	04428L
	M 10	100 mm	04541L
	M 12	100 mm	04566L
	M 13	100 mm	04567L
	M 14	100 mm	04568L

## Screwdriver bit, RB-profile



Chrome-vanadium, e.g. head lamp, valve cover and spark plug cover.



Profile	Size	Length	Part no.
	M 8	140 mm	04542L
	M 9	140 mm	04543L
	M 10	140 mm	04429L
	M 10,3	140 mm	04569L
	M 12	140 mm	04544L
	M 13	140 mm	04570L
	M 14	140 mm	04545L

## Screwdriver bit, RB-profile



Chrome-vanadium, e.g. head lamp, valve cover and spark plug cover.



Profile	Size	Length	Part no.
	M 8	200 mm	04546L
	M 9	200 mm	04547L
	M 10	200 mm	04548L
	M 10,3	200 mm	04571L
	M 12	200 mm	04549L
	M 13	200 mm	04572L
	M 14	200 mm	04550L

## Screwdriver bit, RB profile



Chrome-vanadium

Alfa Romeo  
Fiat  
Lancia



Profile	Size	Length	Part no.
	M 7	240 mm	04426L
	M 8	240 mm	04427L





## IMPACT screwdriver bits, RB profile



suitable for use with impact wrench, groove and bore for ball, 12.5 mm (1/2") drive, 75 mm long

- M5 - 6 - 7 - 8 - 9 - 10 - 12 - 13 - 14



Description	Profile	Part no.
9-piece		S5483

## IMPACT screwdriver bit, RB profile



Impact screwdriver-ready, with groove and bore for the ball, 12.5 mm (1/2") drive, 75 mm long



Profile	Size	Length	Part no.
	M 5	75 mm	S5483-5
	M 6	75 mm	S5483-6
	M 7	75 mm	S5483-7
	M 8	75 mm	S5483-8
	M 9	75 mm	S5483-9
	M 10	75 mm	S5483-10
	M 12	75 mm	S5483-12
	M 13	75 mm	S5483-13
	M 14	75 mm	S5483-14

## Screwdriver bits, T profile without hole



12.5 mm (1/2") drive, chrome-vanadium S2-special steel

- 55 and 100 mm long  
T20 - T25 - T27 - T30 - T40 - T45 - T50 - T55 - T60 - T70
- 140 and 200 mm long  
T40 - T45 - T50 - T55 - T60 - T70



Description	Part no.
32-piece	04423L

## Screwdriver bits, T profile without hole



6-piece set, chrome-vanadium, pressed tightly to the socket, in box with moulded insert



Description	Profile	Part no.
6-piece T30 - T40 - T45 x 53 mm / T40 - T45 - T50 x 100 mm		S5116

## Screwdriver bit, T profile without hole, Short



without tamperproof feature, chrome-vanadium



Profile	Size	Length	Part no.
	T 20	53 mm	05241L
	T 25	53 mm	05242L
	T 27	53 mm	05251L
	T 30	53 mm	05243L
	T 40	53 mm	05244L
	T 45	53 mm	05245L
	T 50	53 mm	05246L
	T 55	53 mm	05247L
	T 60	53 mm	05248L
	T 70	53 mm	05249L

## Screwdriver bit, T profile without hole, Long



without tamperproof feature, chrome-vanadium



Profile	Size	Length	Part no.
	T 20	100 mm	05341L
	T 25	100 mm	05342L
	T 27	100 mm	05340L
	T 30	100 mm	05343L
	T 40	100 mm	05344L
	T 45	100 mm	05345L
	T 50	100 mm	05346L
	T 55	100 mm	05347L
	T 60	100 mm	05358L
	T 70	100 mm	05359L

## Screwdriver bit, T profile without hole, Extra long



without tamperproof feature, chrome-vanadium



Profile	Size	Length	Part no.
	T 40	140 mm	05392L
	T 45	140 mm	05393L
	T 50	140 mm	05394L
	T 60	140 mm	05396L
	T 70	140 mm	05397L
	T 30	300 mm	05398L
	T 80	100 mm	05399L





## Screwdriver bit, T profile without hole

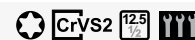

12.5 mm (1/2") drive, chrome-vanadium S2 special steel



Profile	Size	Length	Part no.
	T 40	200 mm	<b>05391L</b>
	T 45	200 mm	<b>05395L</b>
	T 50	200 mm	<b>05388L</b>
	T 55	200 mm	<b>05489L</b>
	T 60	200 mm	<b>05490L</b>
	T 70	200 mm	<b>05491L</b>

## Screwdriver bits, T profile without hole, Long



5-piece set, without tamperproof feature, chrome-vanadium

- T60 - T70 - T80 - T90 - T100



Description	Profile	Length	Part no.
5-piece		80 mm	<b>05380L</b>

## Screwdriver bit, T profile without hole, Long



without tamperproof feature, chrome-vanadium



Profile	Size	Length	Part no.
	T 60	80 mm	<b>05348L</b>
	T 70	80 mm	<b>05349L</b>
	T 80	80 mm	<b>05381L</b>
	T 90	80 mm	<b>05382L</b>
	T 100	80 mm	<b>05383L</b>

## IMPACT screwdriver bit, T profile without hole, Short



made of special steel, 12.5 mm (1/2") drive, suitable for use with impact wrench



Profile	Size	Length	Part no.
	T 20	53 mm	<b>05360L</b>
	T 25	53 mm	<b>05361L</b>
	T 27	53 mm	<b>05362L</b>
	T 30	53 mm	<b>05363L</b>
	T 40	53 mm	<b>05364L</b>
	T 45	53 mm	<b>05365L</b>
	T 50	53 mm	<b>05366L</b>
	T 55	53 mm	<b>05367L</b>

## IMPACT screwdriver bit, T profile without hole, Long



made of special steel, 12.5 mm (1/2") drive, suitable for use with impact wrench



Profile	Size	Length	Part no.
	T 20	100 mm	<b>05350L</b>
	T 25	100 mm	<b>05351L</b>
	T 27	100 mm	<b>05352L</b>
	T 30	100 mm	<b>05353L</b>
	T 40	100 mm	<b>05354L</b>
	T 45	100 mm	<b>05355L</b>
	T 50	100 mm	<b>05356L</b>
	T 55	100 mm	<b>05357L</b>

## IMPACT screwdriver bits, T profile without hole



Impact screwdriver-ready, with groove and bore for the ball, 12.5 mm (1/2") drive, 75 mm long

- T20 - T25 - T30 - T40 - T45 - T50 - T55 - T60 - T70



Description	Profile	Part no.
9-piece		<b>S5480</b>

## IMPACT screwdriver bit, T profile without hole



Impact screwdriver-ready, with groove and bore for the ball, 12.5 mm (1/2") drive, 75 mm long



Profile	Size	Length	Part no.
	T 20	75 mm	<b>S5480-20</b>
	T 25	75 mm	<b>S5480-25</b>
	T 30	75 mm	<b>S5480-30</b>
	T 40	75 mm	<b>S5480-40</b>
	T 45	75 mm	<b>S5480-45</b>
	T 50	75 mm	<b>S5480-50</b>
	T 55	75 mm	<b>S5480-55</b>
	T 60	75 mm	<b>S5480-60</b>
	T 70	75 mm	<b>S5480-70</b>

## Screwdriver bit, T profile with hole, Long



with tamperproof feature



Profile	Size	Length	Part no.
	T 100	75 mm	<b>05389L</b>





## Spiral slot inserts, spiral grooves, Spiral groove

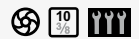

(For example hexagon socket / XZN tripe square / T-profile) or damaged studs (pre-drill!) For turning out round-turned inner profile screws. The left-turning, tapered spiral profile ensures an optimal force connection between tool and defective screw / stud bolts due to its aggressive surface structure and reliably remove the bolt.

- 3/8" inner square / 17 mm outer hexagon:  
2, 3, 4, 5, 6 mm
- 1/2" inner square / 22 mm outer hexagon:  
8, 10, 12, 14 mm



Description	Part no.
9-piece, 2 - 14 mm M5 - M24	<b>05542L</b>
Spiral groove socket with 2 mm diameter out of 05542L	<b>05542L-2</b>
Spiral groove socket with 3 mm diameter out of 05542L	<b>05542L-3</b>
Spiral groove socket with 4 mm diameter out of 05542L	<b>05542L-4</b>

## Spiral groove sockets, Spiral groove

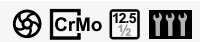

12.5 mm (1/2") drive, for loosening heavily damaged nuts and bolts. The high-alloy special steel combined with the aggressive groove profile makes it possible to loosen all screws.

- 10 - 11 - 12 - 13 - 14 - 15 - 16 - 17 - 19 mm



Description	Part no.
10-piece	<b>05545L</b>

## Helical groove insert, Spiral groove

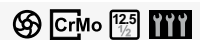

to release badly damaged nuts and bolts. The high-alloy special steel, combined with the aggressive groove profile, loosens all bolts.



Size	Length	Part no.
10 mm	24 mm	<b>05545L-10</b>
11 mm	24 mm	<b>05545L-11</b>
12 mm	24 mm	<b>05545L-12</b>
13 mm	24 mm	<b>05545L-13</b>
14 mm	24 mm	<b>05545L-14</b>
15 mm	24 mm	<b>05545L-15</b>
16 mm	24 mm	<b>05545L-16</b>
17 mm	24 mm	<b>05545L-17</b>
19 mm	24 mm	<b>05545L-19</b>

## Replacement square for push-through ratchet



Chrome-vanadium



Description	Part no.
Square	<b>05917L</b>

## Clamping rail



for 15 sockets with 12.5 mm (1/2") drive



Part no.  
**05600-LEISTE**

## Industrial tool case, Hexagonal



20 mm (3/4") drive

- Ratchet wrench 500 mm
- Extensions 100 - 200 mm
- Sliding handle 450 mm
- Hexagon sockets 19 - 22 - 24 - 27 - 30 - 32 - 36 - 38 - 41 - 46 - 50 mm



### Description

15-piece

### Profile



### Part no.

07650L

## Industrial tool case, Hexagonal



20 mm (3/4") drive, hardness and torque according to DIN

- Ratchet wrench 500 mm
- Extensions 100 - 200 - 400 mm
- Sliding handle 450 mm
- Hexagon sockets 19 - 21 - 22 - 23 - 24 - 26 - 27 - 29 - 30 - 32 - 34 - 36 - 38 - 41 - 46 - 50 mm



### Description

21-piece

Empty case

### Profile



### Part no.

07660L

07660L-KOFFER

## Industrial socket spanner set, Double hexagon



20 mm (3/4") drive, hardness and torque according to DIN

- ratchet wrench 500 mm
- extensions 100 - 200 - 400 mm
- sliding handle 450 mm
- bi-hexagon sockets 19 - 21 - 22 - 23 - 24 - 26 - 27 - 30 - 32 - 34 - 36 - 38 - 41 - 46 - 48 - 50 mm



### Description

21-piece

### Profile



### Part no.

07663L

## Power socket set



Chrome-molybdenum steel for tough and continuous garage use

- slide handle 450 mm long
- ratchet with screw-fit shaft, length: 500 mm
- with quick-action locking on the drive
- extensions in 105 and 250 mm
- cardan joint 105 mm
- sockets 20 mm (3/4"), hexagon, with bore hole and ball groove:
- 19, 21, 22, 23, 24, 26, 27, 29, 32, 35, 36, 38, 41, 46, 50 mm

- all parts can also be operated with 20 mm (3/4") impact screwdrivers, which means it is no longer necessary to buy additional power sockets for pneumatic tools



### Description

21 -piece

### Part no.

07605L



## IMPACT socket set, Double hexagon



High strength, for loosening the articulated shaft screws of various vehicles, e.g. Audi, BMW, Citroën, Ford, Opel, Mercedes-Benz, Nissan, Škoda, Seat, Renault, VW, etc.



### Content:

- 5 extra deep bi hex sockets  
27 - 30 - 32 - 34 - 36 mm
- 3 Inner hex sockets  
14 - 17 - 19 mm

Part no.  
**10186L**

## IMPACT special bit set



Chrome-molybdenum suitable for use with impact wrench. This range is universally suitable for mounting and dismounting work on cylinder head screws, brake calliper screws, steering column stalks (e.g. Actros), wheel flange screws, oil draining screws, bumper attachment etc.



Mercedes-Benz LKW  
DAF  
Iveco LKW  
MAN LKW

Bits with 22 mm hexagon drive and the following profiles:

- T-profile T60, T70, T80, T90, T100
- Inner hexagon 17, 19, 22, 24 mm
- Outer E-profile E18, E20, E22, E24

Additional bit holder with 20 mm (3/4") and 25 mm (1") drive as well as 1 allen key for locking the bits in the holder grub screw

Description  
16-piece

Part no.  
**07940L**

## Ratchet wrench

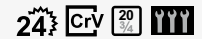

Chrome-vanadium, with socket locking mechanism



Length  
500 mm

Part no.  
**05950L**

## Reversible ratchet

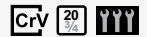

with telescope extension to lock in 6 position from 610 - 1010 mm. Highly durable, 24 teeth, 15° swivel angle.

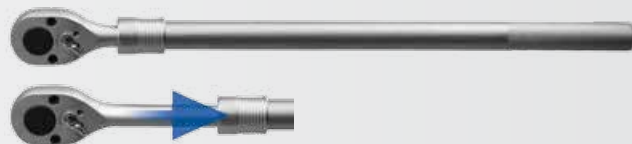

Description  
Reversible ratchet  
Repair set

Part no.  
**05958L**  
**05958L-REP**

## Sliding handle



Chrome-vanadium, matt chrome-plated



Length  
450 mm

Part no.  
**07660L-9**



## Jointed heavy-duty handle

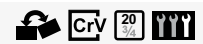

Chrome-vanadium, suitable for transferring extremely high torques.



Description	Length	Part no.
Jointed heavy-duty handle	630 mm	07661L
Repair set		07661L-REP

## Extension

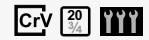

Chrome-vanadium



Length	Part no.
100 mm	07660L-4
200 mm	07660L-5
400 mm	07660L-6

## IMPACT extension



Suitable for use with impact wrench, chrome-molybdenum steel, burnished



Length	Part no.
175 mm	07900L-175
400 mm	07900L-400

## Adapter



Chrome-vanadium, chrome-plated

Reducer socket



Description	Part no.
12.5 mm (1/2") sockets, 20 mm (3/4") ratchet	07903L

## IMPACT Adapter



Reducer socket



① Suitable for use with impact wrench

Description	Part no.
12,5 mm (1/2") sockets - 20 mm (3/4") ratchet	07937L

## IMPACT Adapter



Enlarger socket



① Suitable for use with impact wrench

Description	Part no.
25 mm (1") sockets - 20 mm (3/4") ratchet	07934L





## Spanner socket, Hexagonal



Chrome-vanadium, chrome-plated



Description	Size	Length	Part no.
	19 mm	50 mm	07660L-19
	21 mm	50 mm	07660L-21
	22 mm	50 mm	07660L-22
	23 mm	50 mm	07660L-23
	24 mm	50 mm	07660L-24
	26 mm	50 mm	07660L-26
	27 mm	52 mm	07660L-27
	28 mm	52 mm	07660L-28
	30 mm	54 mm	07660L-30
	32 mm	56 mm	07660L-32
	33 mm	56 mm	07660L-33
	34 mm	57 mm	07660L-34
	36 mm	58 mm	07660L-36
	38 mm	62 mm	07660L-38
	41 mm	64 mm	07660L-41
special socket for Citroën drive shafts	44 mm	70 mm	07660L-44
	46 mm	70 mm	07660L-46
	50 mm	73 mm	07660L-50

## IMPACT spanner sockets, Hexagonal, Short



suitable for use with impact wrench, with groove and bore hole, 20 mm (3/4") drive

- 22 - 24 - 27 - 28 - 30 - 32 - 36 - 38 mm



① short version

Description	Profile	Part no.
8-piece	●	07900L

## IMPACT spanner socket, Hexagonal, Short



Suitable for use with impact wrench, chrome-molybdenum steel, with groove and bore hole for ball, burnished



Size	Length	Part no.
17 mm	50 mm	07900L-17
18 mm	50 mm	07900L-18
19 mm	50 mm	07900L-19
22 mm	50 mm	07900L-22
24 mm	50 mm	07900L-24
27 mm	55 mm	07900L-27
30 mm	55 mm	07900L-30
32 mm	55 mm	07900L-32
33 mm	55 mm	07900L-33
36 mm	55 mm	07900L-36
41 mm	57 mm	07900L-41
46 mm	63 mm	07900L-46
50 mm	68 mm	07900L-50
55 mm	74 mm	07900L-55

## IMPACT spanner sockets, Hexagonal, Long



8-piece set, suitable for use with impact wrench, with groove and bore hole, 20 mm (3/4") drive

- 22 - 24 - 27 - 28 - 30 - 32 - 36 - 38 mm



① long version

Description	Profile	Part no.
8-piece	●	07910L

## IMPACT spanner socket, Hexagonal, Long



Suitable for use with impact wrench, with groove and bore hole, burnished



Description	Size	Length	Part no.
	19 mm	95 mm	07910L-19
	22 mm	90 mm	07910L-22
	24 mm	90 mm	07910L-24
	27 mm	90 mm	07910L-27
	30 mm	90 mm	07910L-30
	32 mm	90 mm	07910L-32
	36 mm	90 mm	07910L-36
including for Ford Sierra + Opel Zafira wheel hub	41 mm	90 mm	07910L-41
	46 mm	95 mm	07910L-46
	50 mm	90 mm	07910L-50

## Socket spanner bit, double hex, Double hexagon

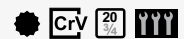

20 mm (3/4") drive to release axle nut connections on various vehicles, e.g. VAG Group



Size	Length	Part no.
19 mm	60 mm	07663L-19
21 mm	60 mm	07663L-21
22 mm	60 mm	07663L-22
23 mm	60 mm	07663L-23
24 mm	60 mm	07663L-24
26 mm	60 mm	07663L-26
27 mm	60 mm	07663L-27
30 mm	80 mm	07663L-30
32 mm	80 mm	07663L-32
34 mm	80 mm	07663L-34
36 mm	80 mm	07663L-36
38 mm	80 mm	07663L-38
41 mm	80 mm	07663L-41
46 mm	80 mm	07663L-46
48 mm	80 mm	07663L-48
50 mm	80 mm	07663L-50



## IMPACT spanner socket insert, Double hexagon, Long

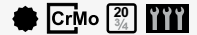

extremely deep bi-hexagon model, Chrome-Molybdänum  
Especially for drive shafts



Size	Part no.
24 mm	10186L-24
27 mm	10186L-27
30 mm	10186L-30
32 mm	10186L-32
34 mm	10186L-34
35 mm	10186L-35
36 mm	10186L-36

## IMPACT socket spanner bit, Double hexagon, Extra deep



with 12 flanks, highly durable, to release tighten drive shaft bolts on the Audi A4 from '01 and Audi A6 from '05 4-wheel drive with 6-speed manual gearbox 0A3 Fiat Ducato, Citroën Jumper, Peugeot Boxer, as well as ball joints on Renault Master, Opel Movano from, '10 etc.



Audi  
Citroën  
Fiat  
Opel  
Peugeot  
Renault

Used like:  
• VAG OE number T40097

Profile	Length	Part no.
	125 mm	05641L

## IMPACT spanner socket, E Profile

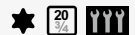

- E-profile
- long version
- material: chrome-molybdenum
- inner hexagonal according to DIN 3121 / ISO 1174
- suitable for machinery usage



Part no.  
05643SB

## IMPACT screwdriver bits, Hexagonal socket



Chrome-molybdenum steel, suitable for impact screwdrivers, with groove and bore hole

- Hexagon socket profile 14, 17, 19, 21, 22, 23, 24 mm
- Inner multipoint with bore hole M16 + M18



VW  
Mercedes-Benz  
Audi  
Seat  
Mercedes-Benz LKW

Description	Part no.
9-piece	07942L

## IMPACT screwdriver bit, internal hex profile

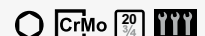

extra-strong, to release drive shaft bolts on various vehicles



Size	Length	Part no.
14 mm	60 mm	04552L
17 mm	60 mm	04553L
19 mm	60 mm	04554L
21 mm	60 mm	04555L
22 mm	60 mm	04556L
23 mm	60 mm	04557L
24 mm	60 mm	04558L
M16	60 mm	04559L
M18	60 mm	04560L

## IMPACT spanner socket insert, Hexagonal socket

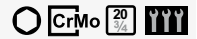

hexagon socket, Chrome-Molybdenum



Size	Part no.
14 mm	10186L-14
17 mm	10186L-17
19 mm	10186L-19

## IMPACT screwdriver bit, Hexagonal socket



high-strength, for loosening the propeller shaft screws on different vehicles, e.g. VAG, BMW, Mercedes-Benz, etc.

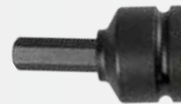

Audi  
BMW  
Mercedes-Benz  
Seat  
Škoda  
VW

Profile	Size	Length	Part no.
○	17 mm	76 mm	10197L
○	19 mm	76 mm	10199L

## IMPACT screwdriver bit, Hexagonal socket, Extra long



special length, for mounting retaining screws on the upper wishbone on rear axles on MAN types TGA and F2000



MAN LKW

Profile	Size	Length	Part no.
○	17 mm	170 mm	10111L

## IMPACT screwdriver bit, Spline



For the mounting of the retaining screw of wheel hub / wheel bearing units on the rear axle of Audi A3, Golf V, Touran as well as similar Škoda.



Audi  
Škoda  
VW

The complete unit is attached to the axle journal and assembled with the multi-point screw.

Profile	Length	Part no.
○	80 mm	301025L

## Locking ring



for 20 mm (3/4") IMPACT bits and extensions



Part no.  
07900L-RING

## Locking pin



for 20 mm (3/4") IMPACT bits and extensions



Part no.  
07900L-STIFT





## Industrial tool case, Hexagonal

25 mm (1" drive), chrome-vanadium

- lever-type ratchet wrench head 200 mm
- extensions 200 + 400 mm
- ratchet handle 550 mm
- sliding block
- inserts 36, 38, 41, 50, 55, 60, 65, 70, 75, 80 mm



Description

16-piece

Part no.

07675L

## Lever ratchet handle

removable head



Length

675 mm

Part no.

05959L

## Sliding handle

Chrome-vanadium, chrome-plated

- round steel 28 mm diameter



Length

560 mm

Part no.

05963L

## Jointed heavy-duty handle

Chrome-vanadium, suitable for transferring extremely high torques.



Length

1000 mm

Part no.

07662L

07662L-REP

## Extension

Chrome-vanadium, high gloss chromium-plated



Length

200 mm

Part no.

07675L-1

400 mm

07675L-2

## IMPACT extension

Suitable for use with impact wrench, chrome-molybdenum steel, burnished

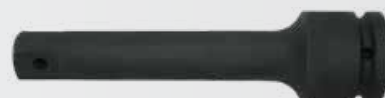

Length

175 mm

Part no.

07985L-175

330 mm

07985L-330

## IMPACT Adapter



Enlarger socket



① Suitable for use with impact wrench

Description	Part no.
25 mm (1") sockets - 20 mm (3/4") ratchet	07934L

## IMPACT Adapter



Reducer socket



① Suitable for use with impact wrench

Description	Part no.
20 mm (3/4") sockets - 25 mm (1") ratchet	07938L

## IMPACT sockets, Hexagonal



8-piece set, 1" drive, chrome-molybdenum, length 58 - 80 mm, high-strength version, with groove and bore

- Spanner size 27, 30, 32, 36, 38, 41, 46, 50 mm



Description	Part no.
8-piece	07980L

## IMPACT spanner socket, Hexagonal, Short



Suitable for use with impact wrench, chrome-molybdenum steel, with groove and bore hole



Size	Length	Part no.
22 mm	60 mm	07985L-22
24 mm	60 mm	07985L-24
27 mm	60 mm	07985L-27
30 mm	63 mm	07985L-30
32 mm	61 mm	07985L-32
33 mm	63 mm	07985L-33
36 mm	65 mm	07985L-36
41 mm	70 mm	07985L-41
46 mm	76 mm	07985L-46
50 mm	68 mm	07985L-50
55 mm	75 mm	07985L-55
60 mm	87 mm	07985L-60
65 mm	90 mm	07985L-65





## Socket spanner bit, Hexagonal, Short



Chrome-vanadium, high gloss chromium-plated



Size	Length	Part no.
36 mm	55 mm	07675L-36
41 mm	55 mm	07675L-41
46 mm	65 mm	07675L-46
50 mm	75 mm	07675L-50
55 mm	80 mm	07675L-55
60 mm	85 mm	07675L-60
65 mm	90 mm	07675L-65
70 mm	95 mm	07675L-70
75 mm	100 mm	07675L-75
80 mm	100 mm	07675L-80

## IMPACT spanner socket, Hexagonal



1" drive, e.g for bolting kingpins



Description	Profile	Size	Part no.
	●	85 mm	10322L
	●	95 mm	10323L
DAF rear axle brake	●	105 mm	10324L

## IMPACT spanner socket, Hexagonal, Long



Suitable for use with impact wrench, chrome-molybdenum steel, with groove and bore hole



Size	Length	Part no.
24 mm	100 mm	07980L-24
27 mm	100 mm	07980L-27
30 mm	90 mm	07980L-30
32 mm	100 mm	07980L-32
36 mm	90 mm	07980L-36
39 mm	100 mm	07980L-39
41 mm	90 mm	07980L-41
46 mm	100 mm	07980L-46
55 mm	100 mm	07980L-55
60 mm	120 mm	07980L-60
65 mm	125 mm	07980L-65
70 mm	125 mm	07980L-70

## Locking ring



for 25 mm (1") IMPACT bits and extensions



① For application with 07985L-STIFT!

Part no.  
07985L-RING



## Locking pin



for 25 mm (1") IMPACT bits and extensions



ⓘ To be used with 07985L-RING

Part no.  
**07985L-STIFT**



## Industrial socket spanner set

Hardness and torque in accordance with DIN, inserts in hexagon profile implementation for maximum torque

### With 6.3 mm (1/4") drive:

- Switching ratchet 155 mm
- Hand grip 150 mm
- Extension 50 and 100 mm
- Sliding grip 115 mm
- Universal joint
- Hexagon insert 4, 4.5, 5, 5.5, 6, 7, 8, 9, 10, 11, 12, 13, 14 mm
- Hexagon insert, long 4, 5, 6, 7, 8, 9, 10 mm
- E-profile E4, E5, E6, E7, E8
- T-profile insert T8, T9, T10, T15, T20, T25, T27, T30
- T-profile insert with face boring T8, T9, T10, T15, T20, T25, T27, T30
- Pozidriv insert No. PZ1, PZ2, PZ3
- Hexagon socket insert 3, 4, 5, 6 mm
- Slot insert 4, 5.5, 6.5, 7 mm
- Cross insert No. PH1, PH2, PH3
- Adapter for 1/4" bits
- Screwdriver for 1/4" bits
- T-profile bit T8, T10, T15, T20, T25
- T-profile bit with face boring T8, T10 (2x), T15, T20 (3x), T25 (2x), T40
- Pozidriv bit No. PZ1, PZ2
- Hexagon socket bit 3, 4, 5, 6 mm
- Hexagon socket with face boring 3, 4, 5, 6 mm
- Slot bit 4, 5, 5.5 mm
- Cross bit No. PH1, PH2
- Two-hole tightener screws bit No. 4, 6, 8
- Internal multi-point XZN screws bit M5, M6, M8
- Three-wing screw bit No. 1, 2, 3
- Four-wing screw bit No. 6, 8, 10
- Square-head bolt bit No. 1, 2

### With 10 mm (3/8") drive:

- Switching ratchet 205 mm
- Extension 125 mm
- Universal joint
- Hexagon insert 10, 11, 12, 13, 14, 15, 16, 17, 18, 19 mm
- Hexagon insert, long 10, 11, 12, 13, 14, 15 mm
- E-profile E8, E10, E12, E14, E16
- Spark plug insert 18 mm
- Adapter for 8 mm bits

### With 12.5 mm (1/2") drive:

- Switching ratchet 250 mm
- Extension 125 and 250 mm
- Universal joint
- Hexagon insert 10, 11, 12, 13, 14, 15, 17, 19, 20, 21, 22, 24, 27, 30, 32 mm
- Hexagon insert, long 16, 17, 18, 19, 22 mm
- E-profile E18, E20, E22, E24
- T-profile insert T55, T60
- Spark plug insert 16 and 21 mm
- Adapter for 8 mm bits
- Adapter from 3/8" inner-square to 1/2" outer-square

### Bits in 8 mm x 30 mm length:

- T-profile bit T25, T27 (2x), T30 (2x), T35 (2x), T40 (3x), T45 (2x), T50 (2x)
- Pozidriv bit No. PZ3, PZ4
- Hexagon socket bit 5.5, 6 (2x), 7, 8 mm
- Slot bit 6, 6.5, 8 mm
- Cross bit No. PH3, PH4
- Internal multi-point XZN screw bit M5, M6, M8, M10

### Offset spanner

- Hexagon key 1.27 (2x), 1.5 (2x), 2 (2x), 2.5, 3, 4, 5 mm

### Open-end ring spanner

- 8, 9, 10, 11, 12, 13, 14, 15, 16, 17, 18, 19 mm



Description  
219-piece

Part no.  
07631L

## Industrial socket spanner set



6.3 mm + 10 mm + 12.5 mm (1/4" + 3/8" + 1/2") drive, chrome-vanadium steel, hardness and torque according to DIN, sockets in wave profile version for maximum torque

### With 6.3 mm (1/4" drive):

- 1 each wave profile socket 4, 4,5, 5, 5,5, 6, 7, 8, 9, 10, 11, 12, 13, 14 mm
- 1 each wave profile socket extra long 4, 5, 6, 7, 8, 9, 10 mm
- 1 each E-profile E4, E5, E6, E7, E8 mm
- 1 each extension in 50 and 100 mm
- 1 each T-profile socket T8, T9, T10, T15, T20, T25, T27, T30
- 1 each T-profile socket, tamperproof T8, T9, T10, T15, T20, T25, T27, T30
- 1 each cross-slot socket Pozidrive no. 0, 1, 2
- 1 each inner hex socket 3, 4, 5, 6 mm
- 1 each plain slot socket 4,5, 5, 6,5, 7 mm
- 1 each cross-slot socket no. 0, 1, 2
- 1 each XZN tripe square socket 8-10-12
- 1 cardan joint
- 1 rotary handle 150 mm
- 1 ratchet 150 mm
- 1 sliding handle 110 mm

### With 10 mm (3/8") drive:

- 1 each wave-profile socket 10, 11, 12, 13, 14, 15, 16, 17, 18, 19 mm
- 1 each wave profile socket extra long 10, 11, 12, 13, 14, 15 mm
- 1 each E-profile E10, E11, E12, E14, E16, E18
- 1 extension 125 mm
- 1 ratchet 200 mm
- 1 spark plug socket 18 mm
- 1 adapter for 8 mm bits
- 1 cardan joint

### With 12.5 mm (1/2") drive:

- 1 each wave profile socket 10, 11, 12, 13, 14, 15, 16, 17, 18, 19, 20, 21, 22, 24, 27, 30, 32 mm
- 1 each wave profile socket extra long, 16, 18 mm
- 1 each pneumatic heavy-duty socket 17-19-21 mm
- 1 each E-profile E20, E24
- 1 each spark-plug socket 16, 21 mm
- 1 rotary handle 250 mm
- 1 extension 125 mm
- 1 ratchet 250 mm
- 1 cardan joint
- 1 adapter for 8 mm bits

### Following bits in 8 mm x 30 mm length:

- 1 each T-profile bit, tamperproof T40, T45, T50, T55, T60, T70
- 1 each T-profile bit T40, T45, T50, T55, T60, T70
- 1 each inner hex bit 7, 8, 10, 12, 14 mm
- 1 each cross-slot bit no. 3, 4
- 1 each plain slot bit 8, 10, 12 mm
- 1 each Pozidrive bit no. 3, 4
- 1 each inner hex key 1,5, 2, 2,5, 3, 4, 5, 6, 8, 10 mm
- 1 each T-profile inner square key T10, T15, T20, T25, T27, 30, T40, T45, T50
- Combination ratchet wrench, 72 teeth
- 8, 9, 10, 11, 12, 13, 14, 15, 16, 17, 18, 19 mm

① Premium assortment with combination ratchet wrenches, impact wheel nut sockets and high-quality allen key sets.

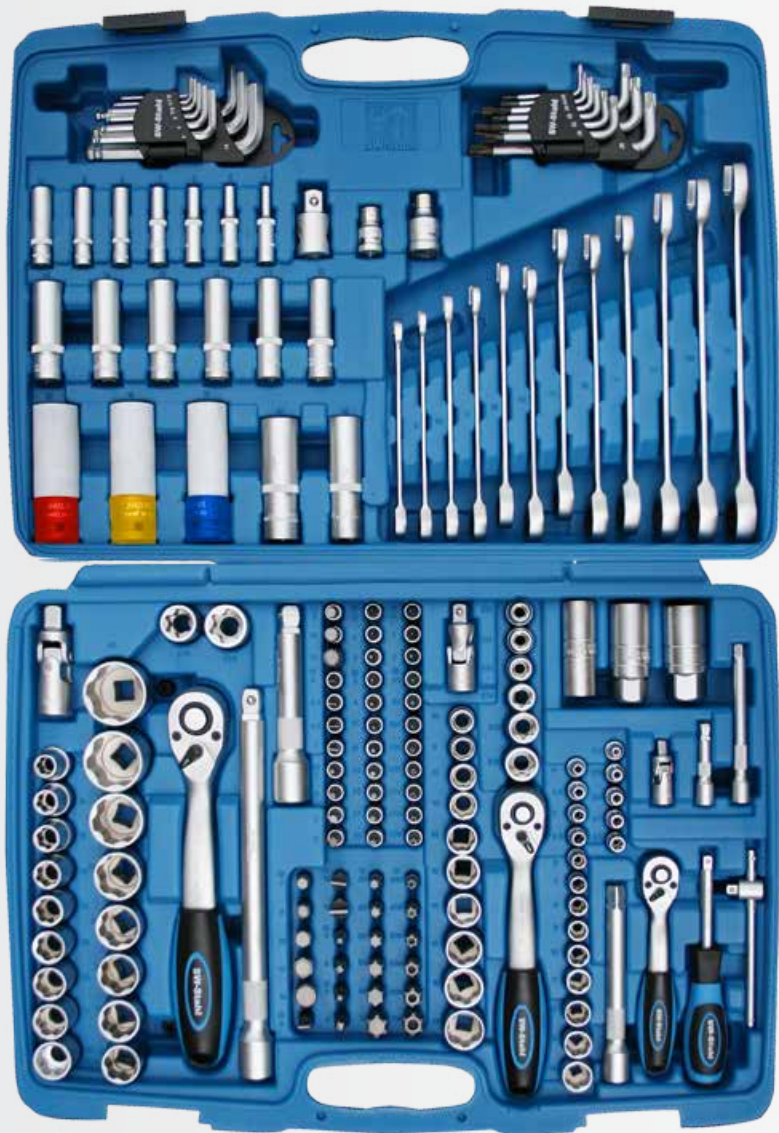

Description  
176-piece  
Empty case

Part no.  
**07635L**  
**07635L-KOFFER**



## Industrial socket spanner set



Hardness and torque according to DIN, /sockets in wave profile version for maximum torque.

### With 6,3 mm (1/4") drive:

- 1 each hexagon socket 4, 4.5, 5, 5.5, 6, 7, 8, 9, 10, 11, 12, 13, 14 mm
- 1 each hexagon socket extra long 4, 5, 6, 7, 8, 9, 10 mm
- 1 each E-profile E4, E5, E6, E7, E8
- 1 each extension in 50 and 100 mm
- 1 each T-profile socket T8, T9, T10, T15, T20, T25, T27, T30
- 1 each T-profile socket, tamperproof T8, T9, T10, T15, T20, T25, T27, T30
- 1 each cross-slot socket Pozidrive no. PZ0, PZ1, PZ2
- 1 each inner hex socket 3, 4, 5, 6 mm
- 1 each plain slot socket 4, 5.5, 6.5, 7 mm
- 1 each cross-slot socket no. 0, 1, 2
- 1 cardan joint
- 1 rotary handle 150 mm
- 1 ERGO reversible ratchet wrench 145 mm, 72 fine-toothed teeth
- 1 sliding handle 110 mm
- 1 adapter for 6.3 mm bits

### With 10,0 mm (3/8") drive:

- 1 each hexagon socket 10, 11, 12, 13, 14, 15, 16, 17, 18, 19 mm
- 1 each hexagon socket extra long 10, 11, 12, 13, 14, 15 mm
- 1 each E-profile E10, E11, E12, E14, E16, E18
- 1 extension 125 mm
- 1 ERGO reversible ratchet wrench 200 mm, 72 fine-toothed teeth
- 1 spark plug socket 18 mm
- 1 adapter for 8 mm bits
- 1 cardan joint

### With 12,5 mm (1/2") drive:

- 1 each hexagon socket 10, 11, 12, 13, 14, 15, 16, 17, 18, 19, 20, 21, 22, 24, 27, 30, 32 mm
- 1 each hexagon socket extra lang 16, 17, 18, 19, 22 mm
- 1 each E-profile E20, E24
- 1 each spark plug socket 16, 21 mm
- 1 extension 250 mm
- 1 extension 125 mm
- 1 ERGO reversible ratchet wrench 205 mm, 72 fine-toothed teeth
- 1 cardan joint
- 1 adapter for 8 mm bits

### Following bits in 8mm hex drive x 30 mm length:

- 1 each T-profile bit, tamperproof T40, T45, T50, T55, T60, T70
- 1 each T-profile bit T40, T45, T50, T55, T60, T70
- 1 each inner hex bit 7, 8, 10, 12, 14 mm
- 1 each cross-slot bit no. 3, 4
- 1 each plain slot bit 8, 10, 12 mm
- 1 each Pozidrive bit no. PZ3, PZ4
- 1 each Allen key 1.27, 1.5, 2, 2.5, 3, 4, 5 mm

### Following bits in 6,3 mm (1/4") drive x 25 mm length:

- 1 each XZN tripe square bit M5, M6, M8
- 1 T-profile bit, tamperproof T7
- 1 each T-profile bit T5, T6, T7
- 1 each wedge groove bit M5, M6, M7, M8, M9
- 1 each 5-star bit TS10, 15, 20, 25, 27, 30, 40, 45



📌 The practical tool set for every working day.

Description	Part no.
171-piece	<b>07630L</b>
Empty case	<b>07630L-KOFFER</b>

## Through-bolt socket spanner set, multi-profile "4 in 1"

CrV YYY

Chrome-vanadium, high-sheen chrome, 6,3 mm (1/4") - 10 mm (3/8") - 12,5 mm (1/2") drive, bits with multi-profile 4-in-1 can be used for hexagon, double-hexagon, inch, metric and E-profile

- through drilled bits allow working through bolts / threaded racks
- 3 fine-toothed ratchets for holding the special bits with 13 -19 - 22 mm
- 12 multi-profile bits for 13 mm chuck: 4,5, 5, 5.5, 6, 6.5, 7, 8, 9, 10, 11, 12, 13 mm
- 12 multi-profile bits for 19 mm chuck: 10, 11, 12, 13, 14, 15, 16, 17, 18, 19 mm
- 8 multi-profile bits for 22 mm chuck: 20, 21, 22, 23, 24, 27, 30, 32 mm
- 3 cardan joints 6,3 mm - 10 mm - 12,5 mm (1/4" - 3/8" - 1/2")
- 3 open and 3 closed extensions
- 3 outer-square adapters for driving "normal" spanner sockets 6,3 mm - 10 mm - 12,5 mm (1/4" - 3/8" - 1/2")



Description  
50-piece

Part no.  
07685L

## Industrial socket spanner set

DIN 72 CrV 12.5 6.3 YYY

6.3 mm + 12.5 mm (1/4" + 1/2") in high-grade aluminium box, sockets with multi-profile "4 in 1", suitable for hex, bi-hex, E-profile and inch sizes

- 6.3 mm + 12.5 mm (1/4" + 1/2") sockets from 4 -32 mm
- 6.3 mm + 12.5 mm (1/4" + 1/2") reversible ratchet wrench, fine-toothed, Ergoform
- T-profile sockets, without bore from T8 - T30
- Cross-slot and Pozidrive sockets 1 + 2
- Inner hex sockets 3 - 6 mm
- Plain slot sockets 4 - 7 mm
- T-profile bits without bore from T40 - T55
- Cross-slot and Pozidrive sockets 3 + 4
- Inner hex sockets 8 - 14 mm
- Plain slot sockets 8 - 12 mm
- Spark plug sockets 16 + 21 mm
- Cardan joints, extensions, handles



Description  
82-piece in multi-profile "4-in-1"  
Empty case

Part no.  
07665L  
07665L-KOFFER





## Industrial socket spanner set, Hexagonal



6.3 mm (1/4"), 10 mm (3/8") drive, chrome-vanadium, hardness and torque according to DIN, hexagon bits for maximum torque

- 2 lever-type reversible ratchet, 72 teeth, fine-toothed 6.3 mm (1/4"), 10 mm (3/8") drive
- 6.3 mm (1/4") drive short bits: 5/32", 3/16", 7/32", 1/4", 9/32", 5/16", 11/32", 3/8", 7/16", 1/2"
- 6.3 mm (1/4") drive deep bits: 1/4", 5/16", 3/8", 7/16", 1/2"
- 1 bit adapter 6.3 mm (1/4")
- 1 rotational handle 6.3 mm (1/4")
- 1 cardan joint 6.3 mm (1/4")
- 1 extension 50 mm, with outer hexagon 6.3 (1/4")
- 1 slide handle with adapter 6.3 mm (1/4")
- 10 mm (3/8") drive short bits: 1/2", 9/16", 19/32", 5/8", 11/16", 3/4", 25/32", 13/16", 7/8", 15/16", 1"
- 10 mm (3/8") drive deep bits: 9/16", 5/8", 11/16", 3/4"
- 1 bit adapter 10 mm (3/8")
- 1 cardan joint 10 mm (3/8")
- 2 x extension 50 and 100 mm, 10 mm (3/8")
- 3 spark plug bits 10 mm (3/8"): 5/8", 3/4", 13/16"
- 29-piece bit assortment with cross slot, straight slot, Pozidrive, inner-hex, T-profile
- 9-piece combination spanner set: 1/4", 5/16", 3/8", 7/16", 1/2", 9/16", 5/8", 11/16", 3/4"
- inner hexagon Allen key set: 1/16", 5/64", 3/32", 1/8", 5/32", 3/16", 1/4", 5/16", 3/8"
- 1 adapter from 6.3 mm (1/4") to 10 mm (3/8")



Description

92-piece

Profile



Part no.

S2299

## Socket spanner set, Hexagonal



with rust-protected surface 6.3 mm (1/4") + 12.5 mm (1/2")

Made of chrome-vanadium, corded, ideal for flat screw heads and nuts where conventional sockets slip and become damaged.

The sockets are profiled to the outer edge and milled in the force-fit area, so that the pressure is transmitted mainly through the flank.

Thanks to the special rust-proof coating they can be used in a wide range of application areas such as shipbuilding and the food industry.

Sizes:

6.3 mm (1/4") drive 4, 5, 6, 7, 8, 9, 10, 11, 12, 13, 14 mm  
12.5 mm (1/2") drive 10, 11, 12, 13, 14, 15, 16, 17, 18, 19, 20, 21, 22, 24, 27, 30, 32 mm



① new FULL SIZE profile + rust-resistant coating

Description

28-piece

Profile



Part no.

05655L

## Universal tool case



6.3 mm + 12.5 mm (1/4" + 1/2") drive, chrome-vanadium, wave profile sockets for maximum torques, hardness, torque and dimensional stability according to DIN

### 6.3 mm (1/4") drive:

- 11 - spanner sockets 4-4.5-5-5.5-6-7-8-9-10-11-13 mm
- 5 - deep spanner sockets 6-7-8-10-12 mm
- 1 - reversible ratchet wrench with quick release feature 150 mm
- 1 - rotary handle 150 mm
- 1 - extension 75 mm
- 1 - cardan joint
- 1 - bit-adapter
- 42 - screwdriver bits, (plain slot, cross-slot, Pozidrive, hex, T-profile, T-profile tamperproof)

### 12,5 mm (1/2") drive:

- 14 - spanner sockets
- 10-11-12-13-14-15-16-17-19-22-24-27-30-32 mm
- 1 - reversible ratchet wrench with quick-release feature, 250 mm
- 1 - extension 125 mm
- 2 - spark-plug sockets 16 + 21 mm
- 1 - cardan joint

### Other tools:

- 3 - plain slot screwdriver 4 x 80 mm, 6.5 x 150 mm, 5 x 200 mm
- 2 - cross-slot screwdriver no. 1 x 80 mm, no. 2 x 100 mm
- 1 - locksmith's hammer 300 gr
- 1 - universal pliers 170 mm
- 1 - water pump pliers 240 mm
- 12 - combination spanner 6-7-8-9-10-11-12-13-14-15-17-19 mm
- 1 - car light tester 6 - 12 V
- 1 - cable lug pressing pliers 200 mm



① The comprehensive range also makes it ideal for mobile repairs

Description	Part no.
104-piece	<b>06960L</b>
Empty case	<b>06960L-KOFFER</b>

## Hinged extensions

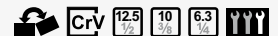

Chrome-vanadium, chrome-plated  
With support square for maximum stability during rigid use of extensions

- 6.3 mm, (1/4") drive: 50 - 100 - 225 mm
- 10 mm (3/8") drive: 75 - 150 - 225 mm
- 12.5 mm (1/2") drive: 50 - 125 - 250 mm



Description	Part no.
9-piece	<b>05985L</b>

## Jointed sockets



with spring system, chrome-vanadium, chrome-plated polished  
Indispensable mounting aid when extensions are used - prevents the mounting connection sagging too much



Description	Part no.
3-piece	<b>06610L</b>





## Adapter set



Chrome-vanadium, matt chromed

- 6.3 mm (1/4") inner to 10 mm (3/8") outer square
- 10 mm (3/8") inner to 12.5 mm (1/2") outer square
- 12.5 mm (1/2") inner to 20 mm (3/4") outer square



Description	Part no.
3-piece	<b>07915L</b>
6,3 mm (1/4") inner to 10 mm (3/8") outer square	<b>07916L</b>
10 mm (3/8") inner to 12,5 mm (1/2") outer square	<b>07917L</b>
12,5 mm (1/2") inner to 20 mm (3/4") outer square	<b>07918L</b>

## Adapter set



with reducer and enlarger sockets in sturdy plastic box, chrome-vanadium, chrome-plated. Contains all sizes between 6.3 mm (1/4") and 20 mm (3/4") as drive and output



Description	Part no.
6-piece	<b>07920L</b>
Empty case	<b>07920L-KOFFER</b>
6,3 mm (1/4") sockets - 10 mm (3/8") ratchet	<b>07901SB</b>
10 mm (3/8") sockets - 12,5 mm (1/2") ratchet	<b>07902SB</b>
12,5 mm (1/2") sockets - 20 mm (3/4") ratchet	<b>07903SB</b>
10 mm (3/8") sockets - 6,3 mm (1/4") ratchet	<b>07904SB</b>
12,5 mm (1/2") sockets - 10 mm (3/8") ratchet	<b>07905SB</b>
20 mm (3/4") sockets - 12,5 mm (1/2") ratchet	<b>07906SB</b>

## IMPACT adapter set



with reducer and enlarger sockets in sturdy plastic box, made of special steel, burnished. Contains all sizes between 6,3 mm (1/4") and 20 mm (3/4") as drive and output.



① Suitable for use with impact wrench

Description	Part no.
6-piece	<b>07930L</b>
Empty case	<b>07930L-KOFFER</b>
6,3 mm (1/4") sockets - 10 mm (3/8") ratchet	<b>07931L</b>
10 mm (3/8") sockets - 6,3 mm (1/4") ratchet	<b>07936L</b>
10 mm (3/8") sockets - 12,5 mm (1/2") ratchet	<b>07932L</b>
12,5 mm (1/2") sockets - 10 mm (3/8") ratchet	<b>07939L</b>
20 mm (3/4") sockets - 12,5 mm (1/2") ratchet	<b>07933L</b>
12,5 mm (1/2") sockets - 20 mm (3/4") ratchet	<b>07937L</b>
25 mm (1") sockets - 20 mm (3/4") ratchet	<b>07934L</b>
20 mm (3/4") sockets - 25 mm (1") ratchet	<b>07938L</b>



## IMPACT-adapter and ball joint set



Chrome-molybdenum steel, suitable for use with impact wrench, with groove and bore adapters:

- 6.3 mm (1/4") inner x 10 mm (3/8") outer
- 10 mm (3/8") inner x 6.3 mm (1/4") outer
- 10 mm (3/8") inner x 12.5 mm (1/2") outer
- 12.5 mm (1/2") inner x 10 mm (3/8") outer
- 12.5 mm (1/2") inner x 20 mm (3/4") outer
- 20 mm (3/4") inner x 12.5 mm (1/2") outer
- 20 mm (3/4") inner x 25 mm (1") outer
- 25 mm (1") inner x 20 mm (3/4") outer

ball joints:

- 6,3 mm (1/4"), 10 mm (3/8"), 12.5 mm (1/2")



Description  
11-piece

Part no.  
07935L

## Special screwing system



for tight installation angles, indispensable for

- timing belt cover
- belt pulley
- water pump
- gear oil control

But also for universal use for all work in the 6,3 mm (1/4") and 10 mm (3/8") range. Combination ratchet spanner with only 50% of the height of a conventional 6,3 mm (1/4") ratchet, key fine-toothed with 72 teeth = 5% swivelling angle.

The open design of the sockets allows mounting on stud bolts. The use of all 10 mm (3/8") is possible using the enclosed adapter.



Description  
29-piece

Part no.  
36000L

## Special screwdriver bits



Chrome-vanadium, 6.3 mm + 12.5 mm (1/4" + 1/2" drive) for almost all standard and special screwing jobs in the automotive sector. Contains bits and sockets in exact useful lengths for working on brakes, cylinder heads, drive shafts, gear and oil draining screws etc.

- 7 T-profile sockets  
T40-45-50-55-60-70 x 140 mm, T80 x 100 mm
- 1 T-profile socket with bore T30 x 300 mm
- 6 inner XZN tripe square sockets M9x100, M10x140, M12x140, M14x140, M16x100, M16 (with bore) x55,
- 1 inner XZN tripe square socket made of chrome-molybdenum steel M18x75 (one-piece)
- 4 RB sockets M7x240, M8x240, M9x100, M10x140
- 1 inner hexagon socket with ball head 5x160 mm
- 4 inner hexagon sockets 10x140 mm, 11x140 mm, 13x140 mm, 7x230 mm
- 5 inner hexagon sockets 14-17-19-22-24 x 55 mm
- 9 IP-profile bits 6.3 mm (1/4")-hexagon with bore: T10-15-20-25-27-30-40-45-50



Description  
38-piece

Part no.  
04600L

Alfa Romeo  
Audi  
BMW  
Daihatsu  
Fiat  
Ford  
Honda  
Lancia  
MAN LKW  
Mercedes-Benz  
Mercedes-Benz LKW  
Opel  
Seat  
Škoda  
Suzuki  
Toyota  
VW  
Yamaha  
Ducati  
Kawasaki  
Moto Morini

## Adapter set for ratchet spanners

Chrome-vanadium, high-sheen chrome-plated, can replace 4 ratchets when used in connection with ratchet ring spanners

- 4 adapters with quick-release:
  - 1/4" square (suitable for 10 mm ring spanner)
  - 3/8" square (suitable for 13 mm ring spanner)
  - 1/2" square (suitable for 19 mm ring spanner)
  - 3/4" square (suitable for 32 mm ring spanner)
- 3 bit adapters:
  - for 1/4" bits (suitable for 10 mm ring spanner)
  - for 8 mm bits (suitable for 13 mm ring spanner)
  - for 10 mm bits (suitable for 19 mm ring spanner)



Description  
7-piece

Part no.  
07925L

## Magnet adapter set

for holding screws securely, particularly in areas that are hard to access.

- 6,3 mm - 10 mm - 12,5 mm (1/4" - 3/8" - 1/2") drive



Description  
3-piece

Part no.  
07929L

## Spiral slot inserts, spiral grooves, Spiral groove

For turning out round-turned inner profile screws. (For example hexagon socket / XZN tripe square / T-profile) or damaged studs (pre-drill!) The left-turning, tapered spiral profile ensures an optimal force connection between tool and defective screw / stud bolts due to its aggressive surface structure and reliably remove the bolt.

- 3/8" inner square / 17 mm outer hexagon:
  - 2, 3, 4, 5, 6 mm
- 1/2" inner square / 22 mm outer hexagon:
  - 8, 10, 12, 14 mm



Description  
9-piece, 2 - 14 mm or M5 - M24

Part no.  
05542L  
05542L-2  
05542L-3  
05542L-4

Spiral slot socket with 2 mm diameter out of 05542L  
Spiral slot socket with 3 mm diameter out of 05542L  
Spiral slot socket with 4 mm diameter out of 05542L



# BIT INSERTS





# BIT INSERTS

# 108-127



▶ 6,3 mm (1/4")

110-119

▶ 8 mm

119-120

▶ 10 mm (3/8")

121-125

▶ Assortments

125-127





## Industrial socket spanner set



Torque and hardness according to DIN, 6.3 mm (1/4") drive, chrome vanadium steel, hexagon sockets for maximum torque

- ratchet wrench, fine-toothed with 72 teeth with socket release feature
- hexagon sockets 4 - 14 mm
- cross slot bits PH 1-2-3, PZ 1-2-3
- plain slot bits 4-7 mm
- T-profile bits without tamperproof feature T10-T40
- inner hexagon sockets 3-8 mm
- flexible shaft
- extensions 50-100 mm
- cardan joint
- handle with 6.3 mm (1/4") drive
- sliding handle
- allen keys 1,2-2,5 mm



**Description**  
46-piece

**Part no.**  
S2146

## Ratchet wrench set



Chrome vanadium S2 special steel. The S-type shaped ratchet wrench has a 6.3 mm (1/4") hex bit drive and a 6.3 mm (1/4") square drive for socket wrench with an insert stop, fine toothed 72 teeth, left/right reversible.

- extension 50 mm
- cardan joint
- bit holder
- T-profile bits 10-15-20-25-27-30
- inner hex bits 3-4-5-6-8 mm
- plain slot bits 4,5-5,5-7 mm
- cross slot bits PH1-PH2-PH3
- Pozidrive bits PZ1-PZ2-PZ3
- socket wrench inserts 6.3 mm (1/4")



**Description**  
33-piece,  
5-6-7-8-9-10-11-12-13 mm

**Part no.**  
36015L

## Professional roll-up bag for bikes



with belt loop, 6,3 mm (1/4") hexagon drive

- 1 handle with magnetic bit holder and quick lock
- 1 extension 125 mm with magnetic bit holder
- 4 spanner sockets with magnet 6, 8, 10, 13 mm
- plain slot bit 5.5 mm
- cross-slot bits PH1, PH2, PH3
- Pozidriv bit PZ2
- hexagon socket bits 3, 4, 5, 6 mm
- TX-profile bits T10, T15, T20, T25, T30, T40, T45



**Description**  
22-piece

**Part no.**  
07450L

## Bit assortment



in plastic box, chrome-vanadium, 6.3 mm (1/4") drive.

- special bits for electronics
- inner hex also in inch sizes
- frequently required bits available more than once
- T-profile with hole
- T-profile without hole
- inner hex
- plain slot
- cross
- pozidrive
- XZN tripe square
- clamping bits
- three-wing
- four-wing
- inner square bits



**Description**  
100-piece

**Part no.**  
04140L

## Bit Set



incl. magnetic screwdriver bit holder, magnetic quick release bit holder and 1/4" socket adapter.

### 1/4" bits, shape c 6.3, length 25 mm:

- cross bit No. PH00, PH0, PH1 (5x), PH2 (5x), PH3 (5x), PH4
- T-profile bit  
T5, T6, T7, T8, T9, T10, T15, T20, T25, T27, T30, T40, T45
- inner hex bit tamperproof 2, 2.5, 3, 4, 5, 6 mm
- inner hex bit 1/16", 5/64", 3/32", 7/64", 1/8", 9/64", 5/32", 3/16", 7/32", 1/4"
- bit for clutch-screws No. #1, #2, #3
- inner hex bit tamperproof 5/64", 3/32", 7/64", 1/8", 9/64", 5/32"
- T-profile bit tamperproof T5, T6, T7, T8, T9, T10, T15, T20, T25, T27, T30, T35, T40, T45
- two-hole tightener screws bit 4, 6, 8, 10 mm
- square-head bolt bit No. #0, #1, #2, #3
- inner hex bit 1.5, 2, 2.5, 3, 3.5, 4, 4.5, 5, 5.5, 6, 7, 8 mm
- internal multi-point XZN screws bit M5, M6, M8
- four-wing screw bit 6, 8, 10 mm
- internal 5 star screws bit  
Ts10, Ts15, Ts20, Ts25, Ts27, Ts30, Ts40, Ts45, Ts50
- slot bit 2, 2.5, 3, 3.5, 4, 4.5, 5, 5.5, 6, 6.5, 7, 8 mm
- Pozidrive bit No.  
PZ00, PZ0, PZ1 (5x), PZ2 (5x), PZ3 (4x), PZ4
- three-wing screw bit No. #1, #2, #3, #4

### 1/4" bits, shape E 6.3, length 50 mm:

- cross bit No. PH1, PH2, PH3
- Pozidrive bit No. PZ1, PZ2, PZ3
- inner hex bit 2.5, 3, 4, 5, 6 mm
- T-profile bit tamperproof T10, T15, T20, T25, T27, T30, T40
- four-wing screw bit 6, 8, 10 mm
- two-hole tightener screws bit 4, 6, 8, 10 mm
- three-wing screw bit No. #1, #2, #3, #4

### 1/4" bits, shape E 6.3, length 75 mm:

- cross bit No. PH1, PH2, PH3
- Pozidrive bit No. PZ1, PZ2, PZ3
- inner hex bit 2.5, 3, 4, 5, 6 mm
- T-profile bit tamperproof T10, T15, T20, T25, T27, T30, T40

### 1/4" sockets, shape E 6.3:

- size 4, 5, 6, 7, 8, 9, 10, 11, 12, 13 mm
- size 5/32", 3/16", 7/32", 1/4", 9/32", 5/16", 11/32", 3/8", 7/16", 1/2"



**Description**  
208-piece

**Part no.**  
04141L





## Bit assortment



in plastic box, chrome-vanadium, 6.3 mm (1/4") drive suitable for machine drive, bits milled off at front allowing use in the most difficult of space situations, particularly in the electronics field, length 75 mm each

- 1 magnetic bit holder
- T-profile with hole T 8-10-15-20-25-27-30-35-40
- T-profile without hole T 10-15-20-25-30
- inner hex with hole 2-2.5-3-4-5-6 mm
- inner hex without hole 4-5-6 mm
- plain slot: 4-5-6 mm
- cross: PH 1, PH 2
- Pozidrive: PZ 1, PZ 2
- Inner XZN tripe square M5-M6-M8
- clamping bits 4-6-8-10 mm
- three-wing no. 1-2-3-4 mm
- four-wing no. 6-8-10 mm
- inner square S1, S2
- clutch C1-C2-C3



**Description**  
50-piece

**Part no.**  
04145L

## Bit assortment



stainless steel (INOX) - especially for working outdoors and with food applications.

- Up to 20% increase in torque values
- Service life tripled
- Prevents extraneous rust on stainless steel screws

17 bits, 25 mm long, 6.3mm (1/4") hexagon drive

- Slot 5.5 - 6.5 mm
- Cross-slot 1 - 2 - 3
- PZ 1 - 2 - 3
- T-profile T10 - 15 - 20 - 25 - 30 - 40
- Hexagon socket 4 - 5 - 6 mm

1 bit holder with fast ejector and magnet



**Description**  
18-piece

**Part no.**  
04128L

## Bit assortment



chrome-vanadium S2 special steel, with colour marking for each profile. In display box with adjustable belt clip.

- 30 bits, 25 mm long
- plain slot 3-4-5-6 mm
- cross 1-2-2-3
- PZ 1-2-2-3
- Hexagon socket 3-4-5-6 mm
- T-profile T10-15-20-25-27-30-40
- T-profile with bore T10-15-20-25-27-30-40
- 6,3 mm (1/4") square adapter
- 1 bit holder with quick ejection



**Description**  
32-piece

**Part no.**  
04126L



## Bit assortment



chrome-vanadium S2 special steel, with colour marking for each profile

- 60 bits, 25 mm long
  - plain slot: 3x 4 mm, 3x 6 mm
  - cross-slot: 3x PH1, 6x PH2, 3x PH3
  - pozidrive: 3x PZ1, 6x PZ2, 3x PZ3
  - hexagon socket: 3x 4 mm, 3x 5 mm, 3x 6 mm
  - T-profile: 2x T10, 2x T15, 2x T20, 2x T25, 2x T27, 2x T30, 2x T40
  - T-profile with hole: 1x T10, T15, T20, T25, T27, T30, T40
- 
- 9 bits, 75 mm long
  - plain slot: 4 mm, 6 mm
  - cross-slot: PH1, PH2, PH3
  - pozidrive: PZ1, PZ2
  - T-profile: T20, T25
- 
- 6,3 mm (1/4") drive
  - 2 bit holders, 1 with quick ejection



Description

71-piece

Part no.

04127L

## Bit assortment



Chrome-vanadium, length 25 mm, assorted in plastic box

6 bits each of the following sizes/profiles:

- plain slot profile 4.5, 6, 7 mm
- cross-slot profile PH1, PH2, PH3
- pozidrive profile PZ1, PZ2, PZ3
- inner hexagon profile 4, 5, 6 mm
- T-profile T10, 15, 20, 25, 30, 40



Description

108-piece

Part no.

04142L

## Bit assortment, T plus profile



the cams of the T-Plus profile have a flatter design compared with the standard T-profile:

- higher torques through optimum interlocking
- longer service life of the bits through improved tool fit

T-Plus is currently used for e.g.:

Fiat 1.3i/1.4i, Ford, General Motors, Nissan, Opel Corsa, Renault, Subaru, Toyota, VW Passat etc. e.g.: flywheel, timing belt cover S2 special steel, in plastic box, with 6.3 mm (1/4") and 10 mm (3/8") socket adapter incl. magnetic bit holder for 6.3 mm (1/4") bits.

T-Plus profile with and without hole:

- TP10 - TP15 - TP20 - TP25 - TP30 - TP40 - TP45 - TP50 - TP55 - TP60



Fiat  
Ford  
Nissan  
Opel  
Renault  
Subaru  
Toyota  
VW

ⓘ T-Plus tools can not be used with T-profile screws!

Description

23-piece

Part no.

04191L

## Mini bit ratchet



With mounting for a 6.3 mm (1/4") hex drive.

- forged steel, chrome-plated
- finely toothed with 72 teeth
- adjustable, with magnet
- incl. hanger hole



Part no.

05745L



## Magnetic holder



for 6.3 mm (1/4") bits



**Length**  
60 mm

**Part no.**  
**MH-4**

## Automatic bit holder



Holder for 6.3 mm (1/4") bits



**Length**  
50 mm  
100 mm

**Part no.**  
**04112L**  
**04113L**

## Special adapter for screwdriver bits



Description	Part no.
6,3 mm (1/4") drive for 6,3 mm (1/4") bits	<b>05400L</b>
12,5 mm (1/2") drive for 8 mm bits	<b>05629L</b>
10 mm (3/8") drive for 8 mm bits	<b>04186-ADAPTER</b>
12,5 mm (1/2") drive for 10 mm bits	<b>05600L</b>
10 mm (3/8") drive for 10 mm bits	<b>05500L</b>

## Adapter set



for drills and cordless screwdrivers, chrome-vanadium  
6.3 + 10 + 12.5 mm square (1/4"+3/8"+1/2") with ball, 6.3 mm (1/4") hex  
drive, for use of standard spanner sockets in chucks



Description	Part no.
3-piece	<b>S8204</b>

## Adapter



for 6.3 mm (1/4") hex to square  
Chrome-vanadium, 25 mm long, burnished, with backstop



**Length**  
25 mm

**Part no.**  
**EH-5**

## Socket adapter



for drills and cordless screwdrivers, chrome-vanadium

6.3 mm (1/4") hex drive, 10 mm (3/8") square with ball, extra short,  
for use of standard spanner sockets in chucks



**Part no.**  
**S8203**

## Socket adapter



for sockets with 6.3 mm (1/4") drive, also suitable for drills and cordless screwdrivers



### Length

25 mm  
50 mm

### Part no.

EH-2  
EH-4

## Screwdriver bit, Slot, Short



chrome-vanadium



Profile	Size	Length	Part no.
	4 mm	25 mm	SB/4-4
	5 mm	25 mm	SB/4-5
	6,5 mm	25 mm	SB/4-6,5
	7 mm	25 mm	SB/4-7

## Screwdriver bit, Slot, Long



chrome-vanadium



Profile	Size	Length	Part no.
	4 mm	75 mm	SB/4-4L
	5 mm	75 mm	SB/4-5L
	6,5 mm	75 mm	SB/4-6,5L
	7 mm	75 mm	SB/4-7L

## Screwdriver bit, Cross, Short



chrome-vanadium



Profile	Size	Length	Part no.
	PH 0	25 mm	KB/4-0
	PH 1	25 mm	KB/4-1
	PH 2	25 mm	KB/4-2
	PH 3	25 mm	KB/4-3
	PH 4	25 mm	KB/4-4

## Screwdriver bit, Cross, Long



chrome-vanadium



Profile	Size	Length	Part no.
	PH 0	75 mm	KB/4-0L
	PH 1	75 mm	KB/4-1L
	PH 2	75 mm	KB/4-2L
	PH 3	75 mm	KB/4-3L
	PH 4	75 mm	KB/4-4L





## Screwdriver bit, Pozidrive, Short



Chrome-vanadium



Profile	Size	Length	Part no.
⊕	PZ 1	25 mm	PB/4-1
⊕	PZ 2	25 mm	PB/4-2
⊕	PZ 3	25 mm	PB/4-3
⊕	PZ 4	25 mm	PB/4-4

## Screwdriver bit, Pozidrive, Long



Chrome-vanadium



Profile	Size	Length	Part no.
⊕	PZ 1	75 mm	PB/4-1L
⊕	PZ 2	75 mm	PB/4-2L
⊕	PZ 3	75 mm	PB/4-3L
⊕	PZ 4	75 mm	PB/4-4L

## Screwdriver bit, Hexagonal socket

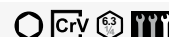

Chrome-vanadium



Profile	Size	Length	Part no.
○	3 mm	25 mm	IBO/4-3
○	4 mm	25 mm	IBO/4-4
○	5 mm	25 mm	IBO/4-5
○	6 mm	25 mm	IBO/4-6
○	7 mm	25 mm	IBO/4-7
○	8 mm	25 mm	IBO/4-8
○	10 mm	25 mm	IBO/4-10

## Screwdriver bit, Hexagonal socket, Long

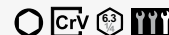

Chrome-vanadium



Profile	Size	Length	Part no.
○	2 mm	75 mm	IBO/4-2L
○	3 mm	75 mm	IBO/4-3L
○	4 mm	75 mm	IBO/4-4L
○	5 mm	75 mm	IBO/4-5L
○	6 mm	75 mm	IBO/4-6L
○	7 mm	75 mm	IBO/4-7L
○	8 mm	75 mm	IBO/4-8L
○	10 mm	75 mm	IBO/4-10L

## Screwdriver bit, Spline



Chrome-vanadium



Profile	Size	Length	Part no.
○	M 4	25 mm	XBO/4-4
○	M 5	25 mm	XBO/4-5
○	M 6	25 mm	XBO/4-6
○	M 8	26 mm	XBO/4-8

## Screwdriver bit, Spline, Long



Chrome-vanadium



Profile	Size	Length	Part no.
○	M 4	75 mm	XBO/4-4L
○	M 5	75 mm	XBO/4-5L
○	M 6	75 mm	XBO/4-6L
○	M 8	75 mm	XBO/4-8L

## Screwdriver bit, T profile without hole



Chrome-vanadium



Profile	Size	Length	Part no.
⊕	T 7	25 mm	TBO/4-T7
⊕	T 8	25 mm	TBO/4-T8
⊕	T 9	25 mm	TBO/4-T9
⊕	T 10	25 mm	TBO/4-T10
⊕	T 15	25 mm	TBO/4-T15
⊕	T 20	25 mm	TBO/4-T20
⊕	T 25	25 mm	TBO/4-T25
⊕	T 27	25 mm	TBO/4-T27
⊕	T 30	25 mm	TBO/4-T30
⊕	T 40	25 mm	TBO/4-T40
⊕	T 45	25 mm	TBO/4-T45

## Screwdriver bit, T profile without hole, Long



Chrome-vanadium



Profile	Size	Length	Part no.
⊕	T 7	75 mm	TBO/4-T7L
⊕	T 8	75 mm	TBO/4-T8L
⊕	T 9	75 mm	TBO/4-T9L
⊕	T 10	75 mm	TBO/4-T10L
⊕	T 15	75 mm	TBO/4-T15L
⊕	T 20	75 mm	TBO/4-T20L
⊕	T 25	75 mm	TBO/4-T25L
⊕	T 27	75 mm	TBO/4-T27L
⊕	T 30	75 mm	TBO/4-T30L
⊕	T 40	75 mm	TBO/4-T40L
⊕	T 45	75 mm	TBO/4-T45L





## Screwdriver bit, T profile with hole, Short



Chrome-vanadium



Profile	Size	Length	Part no.
	T 7	25 mm	TBM/4-T7
	T 8	25 mm	TBM/4-T8
	T 9	25 mm	TBM/4-T9
	T 10	25 mm	TBM/4-T10
	T 15	25 mm	TBM/4-T15
	T 20	25 mm	TBM/4-T20
	T 25	25 mm	TBM/4-T25
	T 27	25 mm	TBM/4-T27
	T 30	25 mm	TBM/4-T30
	T 40	25 mm	TBM/4-T40
	T 45	25 mm	TBM/4-T45



## Screwdriver bit, T profile with hole, Long



Chrome-vanadium



Profile	Size	Length	Part no.
	T 7	75 mm	TBM/4-T7L
	T 8	75 mm	TBM/4-T8L
	T 9	75 mm	TBM/4-T9L
	T 10	75 mm	TBM/4-T10L
	T 15	75 mm	TBM/4-T15L
	T 20	75 mm	TBM/4-T20L
	T 25	75 mm	TBM/4-T25L
	T 27	75 mm	TBM/4-T27L
	T 30	75 mm	TBM/4-T30L
	T 40	75 mm	TBM/4-T40L
	T 45	75 mm	TBM/4-T45L

## Screwdriver bit, Square, Short



chrome-vanadium



Profile	Size	Length	Part no.
	No. 0	25 mm	VKB/4-0
	No. 1	25 mm	VKB/4-1
	No. 2	25 mm	VKB/4-2
	No. 3	25 mm	VKB/4-3

## Screwdriver bit, Square, Long



Chrome-vanadium



Profile	Size	Length	Part no.
□	No. 0	75 mm	VKB/4-0L
□	No. 1	75 mm	VKB/4-1L
□	No. 2	75 mm	VKB/4-2L
□	No. 3	75 mm	VKB/4-3L

# 8 mm

## Screwdriver bit, Slot, Short



Chrome-vanadium



Profile	Size	Length	Part no.
⦿	8 mm	25 mm	SB/8-8
⦿	10 mm	25 mm	SB/8-10
⦿	12 mm	30 mm	SB/8-12

## Power bit, Slot



for hand-held impact wrench with 8 mm drive, e.g. 04100L, 04103L, 04130L, 05040L



Description	Profile	Size	Length	Part no.
Power bit	⦿	8	36 mm	04100L-S8
Power bit	⦿	10	36 mm	04100L-S10

## Screwdriver bit, Cross, Short



Chrome-vanadium



Profile	Size	Length	Part no.
⊕	PH 3	30 mm	KB/8-3
⊕	PH 4	30 mm	KB/8-4

## Power bit, Cross



for hand-held impact wrench with 8 mm drive, e.g. 04100L, 04103L, 04130L, 05040L



Description	Profile	Size	Length	Part no.
Power bit	⊕	PH 2	36 mm	04100L-K2
Power bit	⊕	PH 3	36 mm	04100L-K3





## Screwdriver bit, Pozidrive, Short



Chrome-vanadium



Profile	Size	Length	Part no.
⊕	PZ 3	30 mm	PB/8-3
⊕	PZ 4	30 mm	PB/8-4

## Screwdriver bit, Hexagonal socket, Short



Chrome-vanadium



Profile	Size	Length	Part no.
○	7 mm	30 mm	IBO/8-7
○	8 mm	30 mm	IBO/8-8
○	10 mm	30 mm	IBO/8-10
○	12 mm	30 mm	IBO/8-12
○	14 mm	30 mm	IBO/8-14

## Screwdriver bit, T profile without hole, Short



Chrome-vanadium



Profile	Size	Length	Part no.
⊕	T 40	30 mm	TBO/8-T40
⊕	T 45	30 mm	TBO/8-T45
⊕	T 50	30 mm	TBO/8-T50
⊕	T 55	30 mm	TBO/8-T55
⊕	T 60	30 mm	TBO/8-T60
⊕	T 70	30 mm	TBO/8-T70

## Screwdriver bit, T profile with hole, Short



Chrome-vanadium



Profile	Size	Length	Part no.
⊕	T 7	30 mm	04186T7
⊕	T 8	30 mm	04186-T8
⊕	T 10	30 mm	04186T10
⊕	T 15	30 mm	04186T15
⊕	T 20	30 mm	04186T20
⊕	T 25	30 mm	04186T25
⊕	T 27	30 mm	04186T27
⊕	T 30	30 mm	04186T30
⊕	T 40	30 mm	04186T40
⊕	T 45	30 mm	04186T45
⊕	T 50	30 mm	04186T50
⊕	T 55	30 mm	04186T55
⊕	T 60	30 mm	04186T60
⊕	T 70	30 mm	04186T70



## Combination bit set



Chrome-vanadium, with 10 mm (3/8") + 12,5 mm (1/2") mandrel adapter.

- T-profile T 20 - 25 - 30 - 40 - 45 - 50 - 55, 30 mm short
- T-profile T 20 - 25 - 30 - 40 - 45 - 50 - 55, 75 mm long
- inner hexagon 4 - 5 - 6 - 7 - 8 - 10 - 12 mm, 35 mm short
- inner hexagon 4 - 5 - 6 - 7 - 8 - 10 - 12 mm, 75 mm long
- XZN tripe square 5 - 6 - 8 - 10 - 12, 35 mm short
- XZN tripe square 5 - 6 - 8 - 10 - 12, 75 mm long



Description  
40-piece

Part no.  
04470L

## Screwdriver bits, Hexagonal socket



Chrome-vanadium, with 12.5 mm (1/2") mandrel adapter



Description

Profile

Part no.

15-piece  
4, 5, 6, 7, 8, 10, 12 mm - 30 mm short  
4, 5, 6, 7, 8, 10, 12 mm - 75 mm long

○

04920L

## Screwdriver bit, Hexagonal socket, Short



Chrome-vanadium



Profile

Size

Length

Part no.

○

4 mm

30 mm

05120L

○

5 mm

30 mm

05121L

○

6 mm

30 mm

05122L

○

7 mm

30 mm

05123L

○

8 mm

30 mm

05124L

○

10 mm

30 mm

05125L

○

12 mm

30 mm

05126L

## Screwdriver bit, Hexagonal socket, Long



Chrome-vanadium



Profile

Size

Length

Part no.

○

4 mm

75 mm

05020L

○

5 mm

75 mm

05021L

○

6 mm

75 mm

05022L

○

7 mm

75 mm

05023L

○

8 mm

75 mm

05024L

○

10 mm

75 mm

05025L

○

12 mm

75 mm

05026L



## Screwdriver bits, Spline



Chrome-vanadium, with 12.5 mm (1/2") mandrel adapter



Description	Profile	Part no.
11-piece		
5 - 6 - 8 - 10 - 12, 30 mm short	○	<b>04415L</b>
5 - 6 - 8 - 10 - 12, 75 mm long		
6-piece in self-service pack		
5 - 6 - 8 - 10 - 12, 30 mm short	○	<b>04416SB</b>

## Screwdriver bit, Spline, Short



Chrome-vanadium



Profile	Size	Length	Part no.
○	M 5	30 mm	<b>05320L</b>
○	M 6	30 mm	<b>05321L</b>
○	M 8	30 mm	<b>05322L</b>
○	M 10	30 mm	<b>05323L</b>
○	M 12	30 mm	<b>05324L</b>

## Screwdriver bit, Spline, Long



Chrome-vanadium

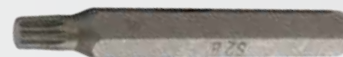

Profile	Size	Length	Part no.
○	M 5	75 mm	<b>05220L</b>
○	M 6	75 mm	<b>05221L</b>
○	M 8	75 mm	<b>05222L</b>
○	M 10	75 mm	<b>05223L</b>
○	M 12	75 mm	<b>05224L</b>

## Combination bit set, RB profile

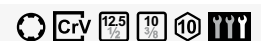

for **Ribe-profile** screws, chrome-vanadium, in plastic box, 10 mm + 12.5 mm (3/8" + 1/2") drive

- M5-6-7-8-9-10-11-12-13, 30 mm long
- M5-6-7-8-9-10-11-12-13-14, 100 mm long
- M10.3 x 100 mm long for cylinder head screws VAG



Audi  
Seat  
Škoda  
VW  
Fiat  
Lancia

Description	Part no.
22-piece	<b>04425L</b>

## Screwdriver bit, RB profile, Short



Chrome-vanadium



Profile	Size	Length	Part no.
	M 5	30 mm	04425K5
	M 6	30 mm	04425K6
	M 7	30 mm	04425K7
	M 8	30 mm	04425K8
	M 9	30 mm	04425K9
	M 10	30 mm	04425K10
	M 11	30 mm	04425K11
	M 12	30 mm	04425K12
	M 13	30 mm	04425K13

## Screwdriver bit, RB profile, Long



Chrome-vanadium



Profile	Size	Length	Part no.
	M 5	100 mm	04425L5
	M 6	100 mm	04425L6
	M 7	100 mm	04425L7
	M 8	100 mm	04425L8
	M 9	100 mm	04425L9
	M 10	100 mm	04425L10
	M 10,3	100 mm	04425L10,3
	M 11	100 mm	04425L11
	M 12	100 mm	04425L12
	M 13	100 mm	04425L13
	M 14	100 mm	04425L14

## T-Profile bit set, T profile without hole



Chrome-vanadium, with 1/2" mandrel adapter



Description	Profile	Part no.
15-piece T 20 - 25 - 30 - 40 - 45 - 50 - 55, 30 mm short T 20 - 25 - 30 - 40 - 45 - 50 - 55, 75 mm long		04420L
7-piece in self-service pack T 25 - 30 - 40 - 45 - 50 - 55, 30 mm short		04421SB



## Screwdriver bit, T profile without hole, Short



Chrome-vanadium



Profile	Size	Length	Part no.
	T 15	30 mm	05339L
	T 20	30 mm	05330L
	T 25	30 mm	05331L
	T 27	30 mm	05337L
	T 30	30 mm	05332L
	T 40	30 mm	05333L
	T 45	30 mm	05334L
	T 50	30 mm	05335L
	T 55	30 mm	05336L
	T 60	50 mm	05338L

## Screwdriver bit, T profile without hole, Long



Chrome-vanadium



Profile	Size	Length	Part no.
	T 15	75 mm	05239L
	T 20	75 mm	05230L
	T 25	75 mm	05231L
	T 27	75 mm	05237L
	T 30	75 mm	05232L
	T 40	75 mm	05233L
	T 45	75 mm	05234L
	T 50	75 mm	05235L
	T 55	75 mm	05236L
	T 60	75 mm	05238L

## Screwdriver bit, T profile without hole



round shaft



Description	Profile	Part no.
T40 x 75 mm		05257L-T40
T50 x 75 mm		05257L-T50

## Screwdriver bits, T profile with hole



Chrome-vanadium, with 10 mm + 12.5 mm (3/8" + 1/2") mandrel adapter

30 mm short:

- T10 - 15 - 20 - 25 - 27 - 30 - 40 - 45 - 50 - 55 - 60 - 70

75 mm long:

- T10 - 15 - 20 - 25 - 27 - 30 - 40 - 45 - 50 - 55 - 60 - 70



Description	Profile	Part no.
26-piece		04480L
Empty case		04480L-KOFFER

## Screwdriver bit, T profile with hole, Short



Chrome-vanadium



Profile	Size	Length	Part no.
⊕	T 10	30 mm	04480K10
⊕	T 15	30 mm	04480K15
⊕	T 20	30 mm	04480K20
⊕	T 25	30 mm	04480K25
⊕	T 27	30 mm	04480K27
⊕	T 30	30 mm	04480K30
⊕	T 40	30 mm	04480K40
⊕	T 45	30 mm	04480K45
⊕	T 50	30 mm	04480K50
⊕	T 55	30 mm	04480K55

## Screwdriver bit, T profile with hole, Long



Chrome-vanadium



Profile	Size	Length	Part no.
⊕	T 10	75 mm	04480L10
⊕	T 15	75 mm	04480L15
⊕	T 20	75 mm	04480L20
⊕	T 25	75 mm	04480L25
⊕	T 27	75 mm	04480L27
⊕	T 30	75 mm	04480L30
⊕	T 40	75 mm	04480L40
⊕	T 45	75 mm	04480L45
⊕	T 50	75 mm	04480L50
⊕	T 55	75 mm	04480L55

## Assortments

### Combination bit set



Chrome-vanadium, with 6,3 mm + 10 mm + 12,5 mm (1/4" + 3/8" + 1/2") socket adapter

- E-profile 6,3 mm (1/4"), E4 - 5 - 6 - 7 - 8
- E-Profil 10 mm (3/8"), E10 - 11 - 12 - 14
- E-profile 12,5 mm (1/2"), E16 - 18 - 20
- T-profile with hole, T10 - 15 - 20 - 25 - 27 - 30 - 40 - 45 - 50 - 55 - 60 x 30 mm
- Inner hex bits 4 - 5 - 6 - 7 - 8 - 10 - 12 - 14 x 30 mm
- XZN tripe square bits M5 - 6 - 8 - 10 - 12 x 30 mm
- T-profile without hole T20 - 25 - 27 - 30 - 40 - 45 - 50 - 55 - 60 x 75 mm long
- Inner hex bits 5 - 6 - 7 - 8 - 10 x 75 mm long
- XZN tripe square bits M6 - 8 - 10 - 12 x 75 mm long



Description  
56-piece

Part no.  
04475L



## Combination screwing set



Chrome-vanadium, in plastic box, socket adapter 6.3 + 10 + 12.5 mm (1/4" + 3/8" + 1/2"), sockets with 6.3 mm (1/4") + 10 mm (3/8") drive

- E-profile sockets 4-5-6-7-8-10-12-14-16-18-20
- T-profile bits with hole 8-9-10-15-20-25-27-30-40-45-50 x 30 mm short
- T-profile bits without hole 25-27-30-40-45-50-55-60-70x 75 mm long



**Description**  
35-piece

**Part no.**  
04440L

## Screw set



for E and T-profile screws with and without tamperproof feature, chrome-vanadium, in plastic box, 6.3 mm (1/4") + 10 mm (3/8") + 12.5 mm (1/2") drive

- 4 adapters 1/4" x 6 mm, 3/8" x 10 mm, 1/2" x 10 mm, 1/2" x 14 mm
- T-profile with hole 1/4" drive T8-9-10-15-20 x 30 mm short
- T-profile with hole 10 mm drive T25-27-30-40-45-50 x 30 mm short
- T-profile without hole 10 mm drive T25-27-30-40-45-50 x 75 mm long
- T-profile without hole 14 mm drive T55-60-70 x 75 mm long
- sockets 1/4" drive E4-5-6-7-8
- sockets 3/8" drive E10-12-14 16-18-20
- flat ring spanners E6x8 - 10x12 - 14x18 - 20x24



**Description**  
39-piece

**Part no.**  
04445L

## Screw set



for E and T-profile screws with and without tamperproof feature, chrome-vanadium, in plastic case, 6.3 + 10 + 12.5 mm (1/4" + 3/8" + 1/2") drive

- screwdriver with hole T8-10-15-20-25-27-30-40
- E-profile 1/2", E12-14-16-18-20-22-24
- E-profile 1/4", E4-5-6-7-8-10-11
- flat ring spanners E6x8-10x12-14x18-20x24
- angled screwdriver T8-10-15-20-25-27-30-40-45-50-55-60
- 6.3 mm (1/4") bits without hole T7-8-9
- 6.3 mm (1/4") bits with hole T10-15-20-25-27-30-40
- sockets 6.3 mm (1/4") without hole T10-15-20-25-27-30
- bits 10 mm drive with hole T40-45-50-55-60-70 x 30 mm short
- bits 10 mm drive without hole T15-20-25-30-40-45-50-55-60 x 75 mm long
- extendable magnetic lifter



**Description**  
72-piece  
Empty case

**Part no.**  
04490L  
04490L-KOFFER

## Combination screwing set



Chrome-vanadium, in plastic case, 10 mm (3/8") mandrel adapter, 6.3 + 10 mm (1/4" + 3/8") inserts

- T-profile 7 - 8 - 9 - 10 - 15 - 20 - 25 - 27 - 30 - 40 - 45 - 50-55 x 30 mm short
- E-profile 4 - 5 - 6 - 7 - 8 - 10 - 12 - 14 - 16

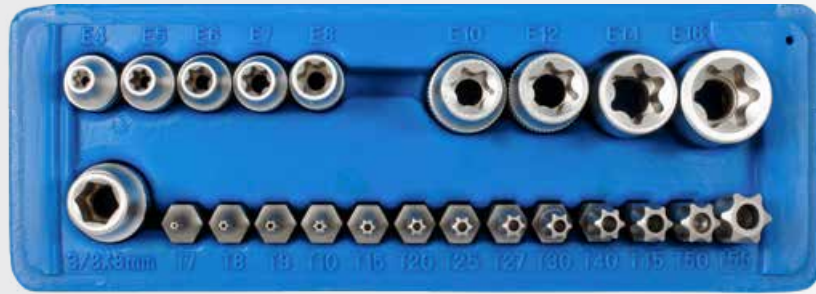

**Description**  
23-piece

**Part no.**  
04186L

## Combination screwing set



sockets with 6.3 mm (1/4") + 10 mm (3/8") + 12.5 mm (1/2") drive

E-sockets:

- E 4-5-6-7-8, 6.3 mm (1/4")
- E 10-11-12-14, 10 mm (3/8")
- E 16-18-20-22-24, 12.5 mm (1/2")

T-profil bits without hole, S2-steel:

- T 20-25-30-40-45-50-55, 10 mm, hexagon per 30 mm and 75 mm



**Description**  
30-piece

**Part no.**  
04442L

## IMPACT special bit set



Chrome-molybdenum suitable for use with impact wrench.

This range is universally suitable for mounting and dismantling work on cylinder head screws, brake calliper screws, steering columns (e.g. Actros), wheel flange screws, oil draining screws, bumper etc.

Bits with 22 mm hexagon drive and the following profiles:

- T-profile T60, T70, T80, T90, T100
- Inner hexagon 17, 19, 22, 24 mm
- Outer E-profile E18, E20, E22, E24

Additional bit holder with 20 mm (3/4") and 25 mm (1") drive as well as 1 allen key for locking the bits in the holder grub screw



**Mercedes-Benz LKW**  
**DAF**  
**Iveco LKW**  
**MAN LKW**

**Description**  
16-piece

**Part no.**  
07940L



# SCREWING TOOLS







# SCREWING TOOLS

128-153



▶ Screwdrivers 130-142



▶ Allen Keys 142-148



▶ T-handle Screwdrivers 148-152



▶ Other Screwing Tools 152-153





## Screwdriver set



- with 2-component handle, blue / black, blade chrome-plated from CV-S2 steel
- with hole in handle for torque reinforcement
- durable by twist-resistant connection of blade and handle
- optimal torque transmission due to ergonomic and non-slip grip
- with black, magnetic tip



Description	Part no.
6-piece, 3+4+5,5+6,5, PH 1+2	31810L
5-piece, 2+3+4+5,5+6,5	31811L
6-piece, T 10+15+20+25+27+30	31812L
4-piece, T 6+7+8+9	31813L
5-piece, 2, PH 0+1+2+3	31814L
6-piece, 4+5,5, PZ 1+2, T 20+25	31815L
6-piece, 4+6,5, PH 1+2, PZ 1+2	31817L

## Workshop screwdriver set



**Racing Experience**, with 2-component handle, black/grey, Blade made of CV steel, with forged hexagon drive

- Good to hold thanks to torsion-resistant connections between blade and handle
- Low-fatigue screwing and optimum torque transmission through ergonomic handle shape



Description	Part no.
5-piece, Slot 3,5 x 75 mm, 5,5 x 100 mm, 6,5 x 125 mm, PH 1+2	31455L
6-piece, Slot 3,5 x 75 mm, 5,5 x 100 mm, 6,5 x 125 mm, PH 1+2+3	31456L

## Workshop screwdriver set, T profile without hole



**Racing Experience**, with 2-component handle, black/grey, Blade made of chrome-molybdenum steel.

- Good to hold thanks to torsion-resistant connections between blade and handle
- Low-fatigue screwing and optimum torque transmission through ergonomic handle shape
- T8 - T10 - T15 - T20 - T25 - T27 - T30 - T40



Description	Profile	Part no.
8-piece		31457L

## Workshop screwdriver set



with 2-component handle and black tip, chrome-vanadium

- 4x PH 1 x 75 mm
- 10x PH 2 x 100 mm
- 1x PH 3 x 150 mm
- 4x plain slot 4 mm x 75 mm
- 10x plain slot 6 mm x 100 mm
- 1 x plain slot 8 mm x 150 mm



**Bargain pack**

Description	Part no.
30-piece	32000L

## Screwdriver set, T profile without hole

11-piece set, chrome-vanadium,

- T 6 - 7 - 8 - 9 - 10 - 15 - 20 - 25 - 27 - 30 - 40



Description	Profile	Part no.
11-piece		31505L

## Screwdriver set, T profile with hole

8-piece, chrome-vanadium, 2-component handle

- T 8 - 10 - 15 - 20 - 25 - 27 - 30 - 40



Description	Profile	Part no.
8-piece		31500L

## Screwdriver set, 5 Star with hole

e.g. for unit pumps on Mercedes-Benz trucks (Actros and Atego), air flow meters on VAG vehicles, spare wheel holders, instrument and interior panelling



Audi  
Mercedes-Benz LKW  
Seat  
Škoda  
VW



Description	Profile	Part no.
8-piece		31510L

## Screwdriver set, Extra long

with 2-component handles

- Cross-slot profile PH 2
- Plain slot profile 6 mm



Description	Blade Length	Part no.
2-piece	450 mm	31604L

## Screwdriver, Slot

- with 2-component handle, blue/black, blade matt chrome-plated made of CV-S2 steel
- black tip
- with hole in handle for increasing torque
- durable through anti-twisting connection of blade and handle
- optimum torque transmission through ergonomic and non-slip handle shape



Description	Profile	Part no.
2,0 x 63 mm		31752SB
3,0 x 80 mm		31753SB
4,0 x 100 mm		31754SB
5,5 x 125 mm		31755SB
6,5 x 150 mm		31756SB



## Garage screwdriver, Slot



**Racing Experience**, with dual-component shaft, black/grey, blade made of CV steel, with forged-on hex

- Durable owing to anti-twist connections between blade and handle
- Fatigue-free operation of the screwdriver and ideal torque transmission thanks to the ergonomic shape of the handle



Description	Profile	Part no.
3,5 x 75 mm	⦿	31411L
4,5 x 90 mm	⦿	31415L
5,5 x 100 mm	⦿	31412L
6,5 x 125 mm	⦿	31413L
8,0 x 150 mm	⦿	31414L

## Workshop screwdriver, Slot



with 2-component handle and black tip, chrome-vanadium



Description	Profile	Part no.
4,0 x 75 mm	⦿	32001L
6,0 x 100 mm	⦿	32002L
8,0 x 150 mm	⦿	32003L

## Carburettor screwdriver, Slot



with 6,0 x 25 mm



Profile	Size	Length	Part no.
⦿	6 mm	75 mm	31608L

## Carburettor screwdriver, Slot



for regulating idling and mixing with Pierburg carburettors on BMW, Mercedes-Benz, Ford, Peugeot and Renault vehicles



**BMW**  
**Ford**  
**Mercedes-Benz**  
**Peugeot**  
**Renault**

Profile	Size	Length	Part no.
⦿	3 mm	360 mm	31603L

## Screwdriver, Cross



- with 2-component handle, blue/black, blade matt chrome-plated made of CV-S2 steel
- black tip
- with hole in handle for increasing torque
- durable through anti-twisting connection of blade and handle
- optimum torque transmission through ergonomic and non-slip handle shape



Description	Profile	Part no.
PH0 x 60 m	⊕	31760SB
PH1 x 80 mm	⊕	31761SB
PH2 x 100 mm	⊕	31762SB
PH3 x 150 mm	⊕	31763SB

## Garage screwdriver, Cross



**Racing Experience**, with dual-component shaft, black/grey, blade made of CV steel, with forged-on hex

- Durable owing to anti-twist connections between blade and handle
- Fatigue-free operation of the screwdriver and ideal torque transmission thanks to the ergonomic shape of the handle



Description	Profile	Part no.
PH 1	⊕	31401L
PH 2	⊕	31402L
PH 3	⊕	31403L

## Workshop screwdriver, Cross



with 2-component handle and black tip, chrome-vanadium



Description	Profile	Part no.
PH1 x 75 mm	⊕	32005L
PH2 x 100 mm	⊕	32006L
PH3 x 150 mm	⊕	32007L

## Carburettor screwdriver, Cross



with PH2 x 25 mm



Profile	D	Length	Part no.
⊕	PH 2 mm	75 mm	31609L

## Screwdriver, Pozidrive



- with 2-component handle, blue/black, blade matt chrome-plated made of CV-S2 steel
- black tip
- with hole in handle for increasing torque
- durable through anti-twisting connection of blade and handle
- optimum torque transmission through ergonomic and non-slip handle shape



Description	Profile	Part no.
PZ1 x 80 mm	⊕	31741SB
PZ2 x 100 mm	⊕	31742SB





## Screwdriver, T profile without hole



- with 2-component handle, blue/black, blade matt chrome-plated made of CV-S2 steel,
- black tip
- with hole in handle for increasing torque
- durable through anti-twisting connection of blade and handle
- optimum torque transmission through ergonomic and non-slip handle shape



Description	Profile	Part no.
T6 x 60 mm		31706SB
T7 x 60 mm		31707SB
T8 x 60 mm		31708SB
T9 x 60 mm		31709SB
T10 x 80 mm		31710SB
T15 x 80 mm		31715SB
T20 x 100 mm		31720SB
T25 x 100 mm		31725SB
T27 x 115 mm		31727SB
T30 x 115 mm		31730SB

## Workshop screwdriver, T profile without hole



Workshop screwdriver with 2-component handle, black grey, RX edition, blade made of high-alloy chrome-plated molybdenum-vanadium steel, with burnished tip

- preserved by the twist of the blade and handle connections
- high torque transfer and optimum transmission of torque due to ergonomic handle shape

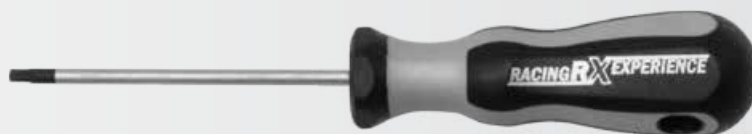

Profile	Size	Blade Length	Part no.
	T 8	70 mm	31208L
	T 10	80 mm	31210L
	T 15	80 mm	31215L
	T 20	90 mm	31220L
	T 25	90 mm	31225L
	T 27	110 mm	31227L
	T 30	110 mm	31230L
	T 40	120 mm	31240L

## Screwdriver, T profile with hole



Chrome-vanadium, 2-component handle



Description	Profile	Part no.
T8 x 75 mm		04490-T8
T10 x 100 mm		04490-T10
T15 x 100 mm		04490-T15
T20 x 100 mm		04490-T20
T25 x 100 mm		04490-T25
T27 x 100 mm		04490-T27
T30 x 100 mm		04490-T30
T40 x 115 mm		04490-T40

## Screwdriver, 5 Star with hole

e.g. for unit pumps on Mercedes-Benz trucks (Actros and Atego), air flow meters on VAG vehicles, spare wheel holders, instrument and interior panelling



Audi  
Mercedes-Benz LKW  
Seat  
Škoda  
VW

Description	Profile	Part no.
IP10 x 125 mm	⊕	31510L-10
IP15 x 125 mm	⊕	31510L-15
IP20 x 125 mm	⊕	31510L-20
IP25 x 125 mm	⊕	31510L-25
IP27 x 125 mm	⊕	31510L-27
IP30 x 125 mm	⊕	31510L-30
IP40 x 125 mm	⊕	31510L-40
IP45 x 125 mm	⊕	31510L-45

## Screwdriver, Hexagonal

with 2-component handle and outer hexagon for increasing torque



Profile	Size	Length	Part no.
⬢	8 mm	240 mm	02083L
⬢	10 mm	240 mm	02084L
⬢	13 mm	240 mm	02087L

## Bit screwdriver

with power handle and removable bit holder

- 2 cross-slot bits PH1, PH2
- 2 plain slot bit 5, 7 mm
- 2 Pozidrive bits PZ1, PZ2



Description	Part no.
8-piece	04104SB

## Telescopic screwdriver

with 6,3 mm (1/4") inner drive, automatic locking, 17-fold length adjustment from 275 - 435 mm, especially handy 2-component handle. Ideal for all fitting work. The bits are held reliably in place by a permanent magnet.



Description	Part no.
275 - 435 mm	02091L

## Hose clamp tool, Hexagonal

Flexible, with encapsulated shaft for protection from humidity, dirt and rust.



Profile	Size	Length	Part no.
⬢	6 mm	260 mm	02076L
⬢	7 mm	260 mm	02077L
⬢	8 mm	260 mm	02078L



## Flexible driver, Hexagonal



with flexible shaft, mainly for use on hose clamps, with hexagonal socket



Profile	Size	Length	Part no.
◆	6 mm	280 mm	02066L
◆	7 mm	280 mm	02067L
◆	8 mm	280 mm	02068L

## Bit screwdriver



with flexible drive shaft



Length	Part no.
260 mm	02095L

## Socket screwdriver



with flexible, encapsulated shaft

- 6,3 mm (1/4") drive



Length	Part no.
306 mm	02090L

## Screwdriver set, Impact-proof



- with 2-component handle, blue/black, blade matt chrome-plated made of CV-S2 steel
- impact-resistant, continuous blade, with impact cap
- with 4 mm hexagon socket for increasing torque
- durable through anti-twisting connection of blade and handle
- optimum torque transmission through ergonomic and non-slip handle shape
- with black, magnetic tip

Content:

- Screwdriver slot 4,5 mm, 5,5 mm, 8 mm
- Philips PH1, PH2



Description	Part no.
5-piece, Sizes 4,5+5,5+8, PH 1+2	31816L

## Screwdriver set



chrome-vanadium with through blades, hexagon drive to increase torque, Ergonomic soft handle

- plain slot 3.2 x 75 - 6 x 38 - 5 x 75 - 6 x 100 - 8 x 150 - 9 x 200
- cross slot PH 0 x 75 - 1 x 75 - 2 x 38 - 2 x 100 - 3 x 150 - 4 x 200



Description	Part no.
12-piece	S7890



## Workshop screwdriver set



chrome-vanadium special steel "S2", extremely wear-resistant with through, impact-proof 6-edge blade, hexagon socket drive for increasing torque and magnetised bronzed blades.  
2-component handle with finely grooved surface

- plain slot screwdriver 3.2 - 9.5
- cross slot screwdriver PH 0 - 4
- different lengths



### Description

12-piece  
empty case

### Part no.

**S7891**  
**S7891-KOFFER**

## Workshop screwdriver set



chrome-vanadium special steel "S2", extremely wear-resistant with through, impact-proof 6-edge blade, hexagon socket drive for increasing torque and magnetised bronzed blades.  
2-component handle with finely grooved surface

- plain slot screwdriver 6.0 x 8.0
- cross slot screwdriver PH 1 - 2 - 3



### Description

5-piece

### Part no.

**S7892**

## Screwdriver impact-proof, Slot



- with 2-component handle, blue/black, continuous impact-resistant blade, with impact cap
- blade matt chrome-plated made of CV-S2 steel,
- black tip
- with hexagon receiver for torque boost
- durable through anti-twisting connection of blade and handle
- optimum torque transmission through ergonomic and non-slip handle shape



### Description

4,5 x 100 mm  
5,5 x 125 mm  
8,0 x 150 mm

### Profile



### Part no.

**31794SB**  
**31795SB**  
**31798SB**

## Workshop screwdriver, Slot



Chrome-vanadium special steel "S2", extremely wear-resistant with through, impact-proof 6-edge blade, hexagon socket drive for increasing torque and magnetised burnished blades.  
2-component handle with finely grooved surface



### Description

3,2 x 75 mm  
5,0 x 75 mm  
6,0 x 38 mm  
6,0 x 100 mm  
8,0 x 150 mm  
9,5 x 200 mm

### Profile



### Part no.

**31801SB**  
**31802SB**  
**31803SB**  
**31804SB**  
**31805SB**  
**31806SB**





## Screwdriver impact-proof, Cross



- with 2-component handle, blue/black, blade matt chrome-plated made of CV-S2 steel,
- black tip
- with hole in handle for increasing torque
- durable through anti-twisting connection of blade and handle
- optimum torque transmission through ergonomic and non-slip handle shape



Description	Profile	Part no.
PH1 x 80 mm	⊕	31791SB
PH2 x 100 mm	⊕	31792SB

## Workshop screwdriver, Cross



Chrome-vanadium special steel "S2", extremely wear-resistant with through, impact-proof 6-edge blade, hexagon socket drive for increasing torque and magnetised burnished blades. 2-component handle with finely grooved surface



Description	Profile	Part no.
PH0 x 75 mm	⊕	31901SB
PH1 x 75 mm	⊕	31902SB
PH2 x 38 mm	⊕	31903SB
PH2 x 100 mm	⊕	31904SB
PH3 x 150 mm	⊕	31905SB
PH4 x 200 mm	⊕	31906SB

## Screwdriver set



Chrome-vanadium, through blade, forged hexagon drive, black tip, wooden handle.

- PH1 x 80 mm, PH2 x 100 mm
- 4.5 x 90 mm, 5.5 x 100 mm, 7.0 x 125 mm, 9.0 x 150 mm



Description	Part no.
6-piece	30501L

## Screwdriver set



Chrome-vanadium, through blade, forged hexagon drive, hexagon blade, black tip, ergonomic wooden handle with grip recesses

- 5,5 - 6,5 - 8,0 mm
- PH1 - PH2



Description	Part no.
5-piece	30800L

## Screwdriver, Slot

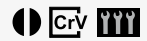

Chrome-vanadium, through blade, forged hexagon drive, black tip, wooden handle



Description	Profile	Part no.
4,5 mm x 90 mm	⦿	30600L
5,5 mm x 100 mm	⦿	30601L
7,0 mm x 125 mm	⦿	30602L
9,0 mm x 150 mm	⦿	30603L
10,0 mm x 175 mm	⦿	30604L
12,0 mm x 200 mm	⦿	30605L

## Screwdriver, Slot

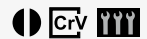

Chrome-vanadium, through blade, forged hexagon drive, hexagon blade, black tip, ergonomic wooden handle with grip recesses



Description	Profile	Part no.
5,5 mm x 100 mm	⦿	30901L
6,5 mm x 125 mm	⦿	30902L
8,0 mm x 150 mm	⦿	30903L
10,0 mm x 175 mm	⦿	30904L
12,0 mm x 200 mm	⦿	30905L
14,0 mm x 250 mm	⦿	30906L

## Screwdriver, Cross



Chrome-vanadium, through blade, forged hexagon drive, black tip, wooden handle



Description	Profile	Part no.
PH1 x 80 mm	⊕	30701L
PH2 x 100 mm	⊕	30702L
PH3 x 150 mm	⊕	30703L

## Screwdriver, Cross



Chrome-vanadium, through blade, forged hexagon drive, hexagon blade, black tip, ergonomic wooden handle with grip recesses



Description	Profile	Part no.
PH1 x 75 mm	⊕	31001L
PH2 x 100 mm	⊕	31002L
PH3 x 150 mm	⊕	31003L
PH4 x 200 mm	⊕	31004L





## Screwdriver, Pozidrive



Chrome-vanadium, through blade, forged hexagon drive, black tip, wooden handle



Description	Profile	Part no.
PZ1 x 80 mm	+	30751L
PZ2 x 100 mm	+	30752L
PZ3 x 150 mm	+	30753L

## Mini-screwdriver, Slot



Assortment:

- 20 x red: 3 x 40 mm
- 20 x yellow: 3 x 60 mm
- 20 x blue: 3 x 80 mm



Description	Profile	Part no.
60 pieces with clip/stand	⊖	32300L

## Mini-screwdriver, Slot



Assortment



Description	Profile	Part no.
12 pieces with plastic clip on card	⊖	32310L
12 pieces with metal clip on card	⊖	32320L

## Safety screwdriver set



with ergonomically shaped plastic handles, 1000 Volt

- Plain slot: 2.5 x 75 - 4 x 100 - 5.5 x 125 - 6.5 x 150 mm
- Cross slot: PH 1 x 80, 2 x 100 mm
- Voltage tester 3 x 60 mm



ⓘ 1000 Volt

Description	Part no.
7-piece	31610L

## Screwdriver set, Slot



Precision mechanic's screwdriver



Description	Part no.
6-piece, 1 - 1,2 - 1,8 - 2,4 - 3 - 3,5 mm	32600SB

## Replug screwdriver set

with 7 replaceable 120 mm precision double blades, ideal e.g. for electronics work

- Holder for blades
- 4 T-profile double blades
- T6xT10, T7xT15, T8xT20, T9xT15
- 3 cross/plain slot double blades
- PH00 x 2 mm, PH 0 x 3 mm, PH1 x 4 mm

The blades are clamped onto the retainer and could be therefore used with an overall length of 135 - 210 mm.



**Description**  
8-piece

**Part no.**  
31400L

## Replug screwdriver set

Chrome-vanadium, ideal e.g. for electronics work

- 1 ratchet screwdriver
- 1 extension with telescopic extension 115 mm
- 1 flexible extension 200 mm
- 6 hexagon sockets 2.5 - 3.0 - 3.5 - 4.0 - 4.5 - 5.0 mm
- 6 reversible blades, 120 mm long
- Plain slot: 2 - 3 - 4 mm
- Cross-slot: No. 00 - 0 - 1
- T-profile, tamperproof: T5 - 6 (2x) - 10 - 15 - 20
- 9 bits T-profile: T4 - 5 - 6 - 7 - 8 - 9 - 10 - 15 - 20
- 7 bits plain slot: 1 - 1.5 - 2 - 2.5 - 3 - 3.5 - 4 mm
- 4 bits cross-slot: No. 000 - 00 - 0 - 1
- 2 bits Pozzi: No. 0 - 1
- 8 bits inner hexagon
- 0.7 - 0.9 - 1.3 - 1.5 - 2.0 - 2.5 - 3.0 - 4.0 mm



**Description**  
45-piece

**Part no.**  
31450L

## Replug screwdriver set

reversible, with two-way handle and blades 175 mm long

- Bit adapter + bit holder
- Blade extension
- Plain slot 4,5 - 6,5 mm
- Inner hex (normal x ball head) 3 - 4 - 5 - 6 - 7 mm
- T-profile T25 x 27 - T30 x 40
- Hexagon socket spanners 5 - 6 - 7 - 8 - 10 - 11 - 12 - 13 mm



**Description**  
19-piece

**Part no.**  
30030L

## Changeable screwdriver

Cross slot PH2  
Plain slot 6 mm

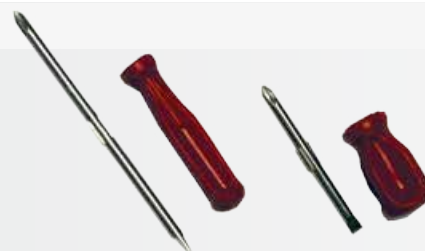

**Description**  
Long model  
Short model

**Part no.**  
31100L  
31200L



## Permanent magnet



For magnetising and demagnetising screwdriver blades, tweezers, etc. Housing made of high-quality ABS plastic, unbreakable, cadmium-free.

The tools are slowly fed through the rectangular opening (+) for magnetisation through the stepped opening (-) for demagnetisation.



Part no.  
30014L

## Allen key

### Allen key set

Chrome-vanadium, on a ring



Description	Produktqualität	Part no.
8-piece Inner hexagon 2 - 2.5 - 3 - 4 - 5 - 6 - 8 - 10 mm	III	04310SB
10-piece, inch sizes Inner hexagon 1/16" - 5/64" - 3/32" - 1/8" - 5/32" - 3/16" - 7/32" - 1/4" - 5/16" - 3/8"	III	S21-202

### Allen key set, Hexagonal socket

Chrome-vanadium, burnished, in folding holder

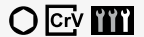

Description	Profile	Part no.
7-piece, inner hexagon 2.5 - 3 - 4 - 5 - 6 - 8 - 10 mm	○	04350SB

## Allen key, Hexagonal socket

DIN ○ CrV 1117

Chrome-vanadium, DIN 911



Profile	Size	Length	Width	Part no.
○	1,5 mm	47 mm	16 mm	04701L
○	2 mm	51 mm	18 mm	04702L
○	2,5 mm	55 mm	20 mm	04703L
○	3 mm	64 mm	22 mm	04704L
○	3,5 mm	68 mm	26 mm	04705L
○	4 mm	72 mm	29 mm	04706L
○	4,5 mm	81 mm	33 mm	04707L
○	5 mm	83 mm	34 mm	04708L
○	5,5 mm	86 mm	37 mm	04709L
○	6 mm	93 mm	38 mm	04710L
○	7 mm	99 mm	41 mm	04711L
○	8 mm	105 mm	43 mm	04712L
○	9 mm	111 mm	46 mm	04713L
○	10 mm	116 mm	48 mm	04714L
○	11 mm	126 mm	52 mm	04715L
○	12 mm	135 mm	56 mm	04716L
○	13 mm	141 mm	62 mm	04717L
○	14 mm	150 mm	69 mm	04718L
○	15 mm	157 mm	70 mm	04719L
○	16 mm	162 mm	74 mm	04720L
○	17 mm	174 mm	78 mm	04721L
○	18 mm	184 mm	82 mm	04722L
○	19 mm	200 mm	90 mm	04723L
○	20 mm	202 mm	92 mm	04724L
○	21 mm	204 mm	97 mm	04725L
○	22 mm	222 mm	102 mm	04726L
○	24 mm	242 mm	110 mm	04727L





## Allen key, Hexagonal socket, Extra long



Chrome-vanadium, DIN 911



ⓘ Extra long

Profile	Size	Length	Width	Part no.
○	1,5 mm	99 mm	18 mm	04801L
○	2 mm	99 mm	18 mm	04802L
○	2,5 mm	110 mm	20 mm	04803L
○	3 mm	125 mm	24 mm	04804L
○	4 mm	137 mm	28 mm	04805L
○	5 mm	159 mm	32 mm	04806L
○	6 mm	180 mm	37 mm	04807L
○	7 mm	188 mm	40 mm	04808L
○	8 mm	197 mm	44 mm	04809L
○	9 mm	215 mm	46 mm	04810L
○	10 mm	221 mm	50 mm	04811L
○	12 mm	225 mm	55 mm	04813L
○	14 mm	282 mm	70 mm	04815L
○	17 mm	323 mm	77 mm	04818L
○	19 mm	365 mm	88 mm	04819L
○	22 mm	405 mm	95 mm	04820L
○	24 mm	430 mm	105 mm	04821L

## Pin-type Allen key



Size	Part no.
3 mm	04750L
4 mm	04751L
5 mm	04752L
6 mm	04753L
8 mm	04754L
10 mm	04755L

## Allen key set, Hexagonal socket ball head



Chrome-vanadium

- 130 - 320 mm long, ball-head version on long blade, mounting angle up to 15°
- 3 - 4 - 5 - 6 - 7 - 8 - 10 - 12 - 14 - 17 mm



Description	Profile	Part no.
10-piece	⊗	04380L



## Allen key set, Hexagonal socket ball head

Chrome-vanadium, with ball head on long blade, allows angled fitting up to 15°.

- Inner hexagon 2.5 - 3 - 4 - 5 - 6 - 8 - 10 mm



### Description

7-piece

### Profile



### Part no.

04360SB

## Allen key set, Hexagonal socket ball head

Chrome-vanadium, in patented holder, angled fitting up to 15°.

① Holder can be used as T-handle!



### Description

8-piece,  
inner hexagon 2 - 2.5 - 3 - 4 - 5 - 6 - 8 - 10 mm

### Profile



### Part no.

04370SB

## Allen key set, Hexagonal socket ball head

Chrome-vanadium, spheroid head with inlaid permanent magnet on the long handle; enables assembly angles up to 15°



### Description

9-piece, inner hexagon  
1.5 - 2 - 2.5 - 3 - 4 - 5 - 6 - 8 - 10 mm

### Profile



### Part no.

04205SB

## Allen key set, Hexagonal socket ball head

Chrome-vanadium

- one blade is extra short for where there is little space above the screw
- one blade is extra long for the greatest possible torque
- inner hexagon version on the long blade as ball-head mounting angle up to 15°

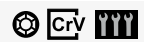

### Description

9-piece, inner hexagon  
1.5 - 2 - 2.5 - 3 - 4 - 5 - 6 - 8 - 10 mm

### Profile



### Part no.

04210SB

## Allen key set, Hexagonal socket ball head

Chrome-vanadium, with ball head on long leg angled fitting up to 15°



Harley Davidson

### Description

9-piece, inner hexagon  
1/16", 5/64", 3/32", 1/8", 5/32", 3/16", 1/4", 5/16", 3/8"

### Profile



### Part no.

S21-205

## Allen key set, RB profile

Chrome-vanadium

- M 4 - 5 - 6 - 7 - 8 - 9 - 10



### Description

7-piece

### Profile



### Part no.

04495L



## Allen key set, T profile without hole

Chrome-vanadium, in plastic box

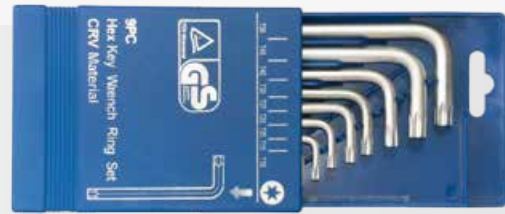

Description	Profile	Part no.
T-profile T 10 - 15 - 20 - 25 - 27 - 30 - 40 - 45 - 50	⊗	04410SB



## Allen key set, T profile without hole

Chrome-vanadium, bronzed, in folding holder



Description	Profile	Part no.
8-piece, T-profile without hole T 9 - 10 - 15 - 20 - 25 - 27 - 30 - 40	⊗	04450SB



## Allen key set, T profile without hole

Chrome-vanadium, in patented holder, angled fitting up to 15°.



① Holder can be used as T-handle!

Description	Profile	Part no.
8-piece, T-profile without hole T 10 - 15 - 20 - 25 - 30 - 40 - 45 - 50	⊗	04485SB



## Allen key set, T profile without hole

Chrome-vanadium



- one blade is extra short for where there is little space above the screw
- one blade is extra long for the greatest possible torque



Description	Profile	Part no.
9-piece, T-profile T 10 - 15 - 20 - 25 - 27 - 30 - 40 - 45 - 50	⊗	04220SB

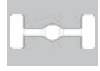

## Allen key set, T profile without hole, Extra long

Chrome-vanadium, high-alloy, with ball head on long blade, makes fitting work possible in cramped conditions, high-strength, extra long version, mounting angle up to 15°



- T 10 - 15 - 20 - 25 - 27 - 30 - 40 - 45 - 50



Description	Profile	Part no.
9-piece with ball head on long blade	⊗	04230L



## Allen key, T profile without hole, Extra long



Chrome-vanadium, high-alloy, with ball head on long blade, makes fitting work possible in cramped conditions, high-strength, extra long version, mounting angle up to 15°

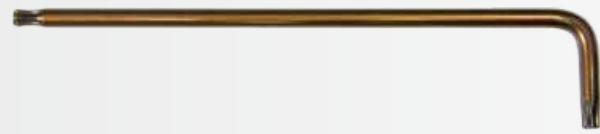

Size	Part no.
T 10	04230L-T10
T 15	04230L-T15
T 20	04230L-T20
T 25	04230L-T25
T 27	04230L-T27
T 30	04230L-T30
T 40	04230L-T40
T 45	04230L-T45
T 50	04230L-T50

## Allen key, T profile without hole



chrome-vanadium



Profile	Size	Length	Width	Part no.
	T 8	49 mm	17 mm	TW-T8
	T 10	59 mm	23 mm	TW-T10
	T 15	64 mm	26 mm	TW-T15
	T 20	70 mm	27 mm	TW-T20
	T 25	75 mm	28 mm	TW-T25
	T 27	69 mm	28 mm	TW-T27
	T 30	83 mm	31 mm	TW-T30
	T 40	88 mm	35 mm	TW-T40
	T 45	95 mm	40 mm	TW-T45
	T 50	111 mm	46 mm	TW-T50
	T 55	123 mm	52 mm	TW-T55
	T 60	138 mm	59 mm	TW-T60

## Allen key set, T profile with hole



Chrome-vanadium, burnished, in folding holder



Description	Profile	Part no.
8-piece, T-profile with hole T 9 - 10 - 15 - 20 - 25 - 27 - 30 - 40		04455L

## Allen key set, T profile with hole



Chrome-vanadium, in patented holder



Holder can be used as T-handle!

Description	Profile	Part no.
8-piece, T-profile, tamperproof T 10 - 15 - 20 - 25 - 30 - 40 - 45 - 50		04484L





## Allen key set, T profile with hole

Chrome-vanadium, with magnet on the long blade



Description	Profile	Part no.
9-piece T-profile, T10 - 15 - 20 - 25 - 27 - 30 - 40 - 45 - 50	⬤	04215SB

## Allen key set, 5 Star with hole

Chrome-vanadium

- T10, T15, T20, T25, T27, T30, T40, T45, T50



Description	Profile	Part no.
9-piece, 5-star profile with tamperproof feature	⬤	04494L

## T-handle Screwdriver

### T-handle screwdriver, Hexagonal

Chrome-vanadium, with hook hole

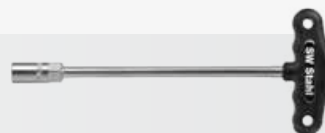

Profile	Size	Blade Length	Part no.
⬤	6 mm	230 mm	02080-6X230
⬤	7 mm	230 mm	02080-7X230
⬤	8 mm	230 mm	02080-8X230
⬤	9 mm	230 mm	02080-9X230
⬤	10 mm	230 mm	02080-10X230
⬤	11 mm	230 mm	02080-11X230
⬤	12 mm	230 mm	02080-12X230
⬤	13 mm	230 mm	02080-13X230
⬤	14 mm	230 mm	02080-14X230

### T-handle screwdriver set, Hexagonal

with patented magnetic system, screws and nuts are held reliably

- 8 x 230 mm
- 10 x 350 mm
- 13 x 230 mm

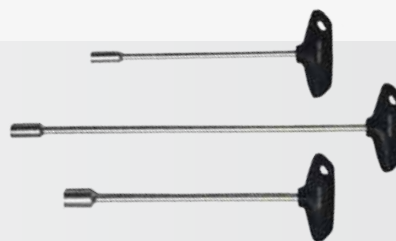

Description	Profile	Part no.
3-piece	⬤	02050L

### T-handle screwdriver, Hexagonal

with patented magnetic system, screws and nuts are held reliably



Profile	Size	Blade Length	Part no.
⬤	8 mm	230 mm	02051L
⬤	10 mm	230 mm	02053L
⬤	13 mm	230 mm	02055L
⬤	10 mm	350 mm	02063L

## Full-metal screwdriver, Hexagonal

**Racing Experience**, with extra long and heavy T-handle for high screwing speeds, with outer hexagon for the placement of jaw or ring spanners



Description	Part no.
6 x 250 mm, T-handle 180 mm	02085L-6
8 x 250 mm, T-handle 200 mm	02085L-8
10 x 250 mm, T-handle 200 mm	02085L-10
12 x 250 mm, T-handle 200 mm	02085L-12
13 x 250 mm, T-handle 250 mm	02085L-13

## T-handle screwdriver, E Profile

Chrome-vanadium, with hook hole, for E-profile screws

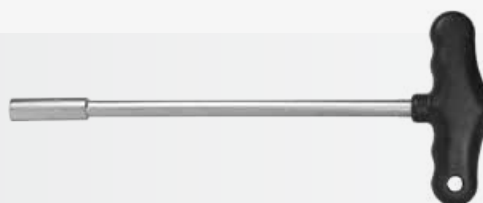

Profile	Size	Length	Part no.
★	E 6	230 mm	02030L
★	E 7	230 mm	02031L
★	E 8	230 mm	02032L
★	E 12	230 mm	02034L
★	E 14	230 mm	02035L
★	E 16	230 mm	02036L

## Screwdriver set, Inner hexagon, ball head

with T-handle and hook hole in stand, chrome-vanadium

- 2 - 3 - 4 mm x 100 mm length
- 5 - 6 - 7 mm x 150 mm length
- 8 - 10 mm x 200 mm length

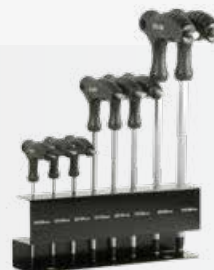

Description	Profile	Part no.
8-piece	⊗	31650L

## T-handle screwdriver, Inner hexagon, ball head

with T-handle and hook hole, spherical head on a long handle, chrome-vanadium

assembly angle up to 15°

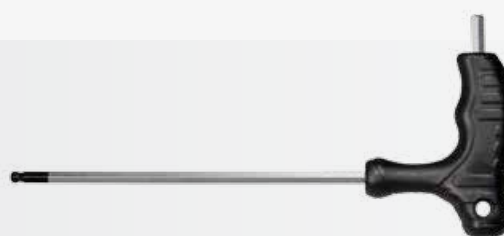

Description	Profile	Part no.
2,0 x 100 mm	⊗	31650L-2
3,0 x 100 mm	⊗	31650L-3
4,0 x 100 mm	⊗	31650L-4
5,0 x 150 mm	⊗	31650L-5
6,0 x 150 mm	⊗	31650L-6
7,0 x 150 mm	⊗	31650L-7
8,0 x 200 mm	⊗	31650L-8
10,0 x 200 mm	⊗	31650L-10



## T-handle pin wrench assortment, Inner hexagon



**Racing Experience**, full metal with t-profile at three ends, high strength, slim, for quick and /precise fitting work

- 2 - 2,5 - 3 - 4 - 4,5 - 5 - 6 - 7 - 8 - 10 mm



Description	Profile	Part no.
10-piece	○	31655L

## T-handle pin wrench, Inner hexagon



**Racing Experience**, full metal with t-profile at three ends, high strength, slim, for quick and / precise fitting work

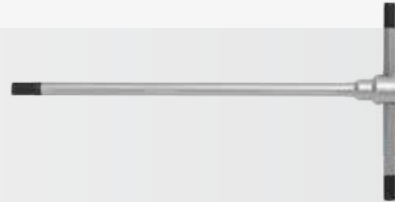

Profile	Size	Length	Width	Part no.
○	2 mm	125 mm	65 mm	31655L-2
○	3 mm	125 mm	65 mm	31655L-3
○	8 mm	250 mm	125 mm	31655L-8
○	14 mm	340 mm	170 mm	31655L-14

## T-handle screwdriver set, T profile without hole



Chrome-vanadium, with hook hole.

- T10 x 128 mm long
- T15 - 20 - 25 - 27 - 30 - 40 x 235 mm long



Description	Profile	Part no.
7-piece	⊗	02020L

## T-handle screwdriver, T profile without hole



Chrome-vanadium, with hook hole

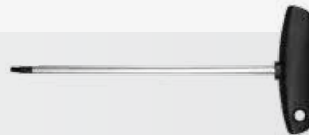

Description	Profile	Part no.
T10 x 100 mm	⊗	02010L
T15 x 200 mm	⊗	02011L
T20 x 200 mm	⊗	02012L
T25 x 200 mm	⊗	02013L
T27 x 200 mm	⊗	02014L
T30 x 200 mm	⊗	02015L
T40 x 200 mm	⊗	02016L

## T-handle screwdriver set, T profile without hole, Extra long



Chrome-vanadium, with hook hole, total length 400 mm for long fitting distances on instruments, engine, bodywork, fuseboxes etc.

- T10 - T15 - T20 - T25 - T27 - T30

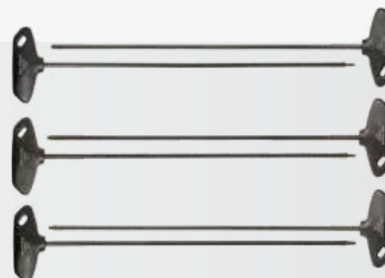

Mercedes-Benz LKW  
Seat  
VW  
Renault  
Mercedes-Benz  
Ford  
BMW

① Extra long

Description	Profile	Part no.
6-piece	⊗	32500L

## T-handle screwdriver, T profile without hole, Extra long



Chrome-vanadium, with hook hole for long fitting distances on instruments, engine, bodywork, fuseboxes etc.



ⓘ Extra long

Profile	Size	Length	Part no.
	T 10	390 mm	32500L-T10
	T 15	390 mm	32500L-T15
	T 20	390 mm	32500L-T20
	T 25	390 mm	32500L-T25
	T 27	390 mm	32500L-T27
	T 30	390 mm	32500L-T30

## Screwdriver set, T profile without hole



with T-handle and hook hole in stand, chrome-vanadium

- T10 - 15 - 20 - 25 x 100 mm length
- T27 - 30 - 40 x 150 mm length
- T45 - 50 x 200 mm length



Description	Profile	Part no.
9-piece		31660L

## T-handle screwdriver, T profile without hole



with T-handle and hook hole, chrome-vanadium



Description	Profile	Part no.
T10 x 100 mm		31660L-T10
T15 x 100 mm		31660L-T15
T20 x 100 mm		31660L-T20
T25 x 100 mm		31660L-T25
T27 x 150 mm		31660L-T27
T30 x 150 mm		31660L-T30
T40 x 150 mm		31660L-T40
T45 x 200 mm		31660L-T45
T50 x 200 mm		31660L-T50

## T-handle pin wrench assortment, T profile without hole



**Racing Experience**, full metal with t-profile at three ends, high strength, slim, for quick and /precise fitting work

- T10-15-20-25-27-30-40-45-50-55



Description	Profile	Part no.
10-piece		31665L



# T-handle Screwdriver



## T-handle pin wrench assortment, T profile without hole

**Racing Experience**, full metal with t-profile at three ends, high strength, slim, for quick and /precise fitting work

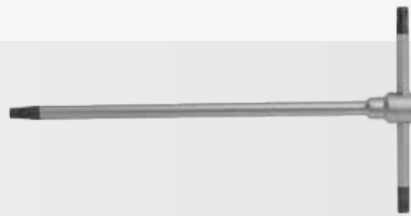

Profile	Size	Length	Width	Part no.
⊗	T 10	125 mm	65 mm	<b>31665L-10</b>
⊗	T 15	125 mm	65 mm	<b>31665L-15</b>
⊗	T 20	125 mm	65 mm	<b>31665L-20</b>
⊗	T 25	180 mm	90 mm	<b>31665L-25</b>
⊗	T 27	180 mm	90 mm	<b>31665L-27</b>
⊗	T 30	180 mm	90 mm	<b>31665L-30</b>
⊗	T 40	210 mm	105 mm	<b>31665L-40</b>
⊗	T 45	250 mm	125 mm	<b>31665L-45</b>
⊗	T 50	250 mm	125 mm	<b>31665L-50</b>
⊗	T 55	300 mm	145 mm	<b>31665L-55</b>
⊗	T 60	320 mm	165 mm	<b>31665L-60</b>

## T-handle screwdriver



with 1/4" drive

- the freewheeling sleeve handle allows screws and nuts to be screwed in and out quickly
- the knurl ensures a secure grip
- the sleeve handle can be locked into 4 positions, thus enabling the T-handle to be used in each position
- the narrow long shape is ideal for difficult positions and in case of less space
- the long T-handle ensures optimal force transfer



**Length**  
310 mm

**Part no.**  
**02086L**

## Other Screwing Tools

### Hand-held impact wrench set

in metal box, with 2 cross and 2 plain slot blades each



Description	Part no.
5-piece, workshop model	<b>04103L</b>
5-piece, standard model	<b>04100L</b>

### Professional manual impact wrench set

profi version, with protective handle, high-alloy plain and cross slot bits in long and short version, especially for extremely tight screws e.g. on generator, brake callipers etc. 12.5 mm (1/2") drive, also suitable for plug-type bits, can be switched right/left. Can be used for bits with 8 mm drive, extra-strong, impact-absorbing handle, high-strength bits made of hardened special steel.

- cross slot PH2 and PH3, 36 mm long
- plain slot 8 and 10 mm, 36 mm long
- cross slot PH2 and plain slot 8 mm, 80 mm long



Description	Part no.
8-piece	<b>04130L</b>



## Hand-held impact wrench set



with oversize inner hex bits for worn screws, high-strength version.

The tools are made with a slight oversize and are tapered. This means the bits can be struck into the screw head by means of a hammer and then loosened with a spanner or even better with the hand-held impact wrench included.



① Ideal for brake discs, brake callipers, starters, belt pulley etc.

Description	Profile	Size	Part no.
12-piece			<b>05040L</b>
		T 40	<b>05233L</b>
Oversize bit 5,1 mm		5,1 mm	<b>05035L</b>
Oversize bit 6,1 mm		6,1 mm	<b>05036L</b>
Oversize bit 7,1 mm		7,1 mm	<b>05037L</b>
Oversize bit 8,1 mm		8,1 mm	<b>05038L</b>

## Power bit, Slot



for hand-held impact wrench with 8 mm socket, e.g. 04100L, 04103L, 04130L, 05040L



Description	Profile	Size	Length	Part no.
Power bit		8	36 mm	<b>04100L-S8</b>
Power bit		10	36 mm	<b>04100L-S10</b>

## Power bit, Cross



for hand-held impact wrench with 8 mm socket, e.g. 04100L, 04103L, 04130L, 05040L



Description	Profile	Size	Length	Part no.
Power bit		PH 2	36 mm	<b>04100L-K2</b>
Power bit		PH 3	36 mm	<b>04100L-K3</b>



# PLIERS





# PLIERS

# 154-179



▶ Assortments	156-158
▶ Water Pump Pliers	158-160
▶ Combination Pliers	161
▶ Side Cutters	161-162
▶ Long Nose Pliers	162-163
▶ Carpenters Pincers	163
▶ Tower Pincers	164
▶ Pipe Wrench	164
▶ Bolt cutters	164
▶ Crimping Pliers	165-166
▶ Rivet Pliers	166-167
▶ Electronics Pliers	168-170
▶ Other Pliers	170-178





## Pliers set

DIN CrV YYY YYY

with heavy-duty insulated handles

- water pump pliers 240 mm
- universal pliers 180 mm
- side-cutting pliers 160 mm
- telephone pliers straight 200 mm
- telephone pliers bent 200 mm



Description

Part no.

5-piece

Z1120

## Pliers set

DIN YYY

with strong insulated handles

- telephone pliers, 200 mm (40750L)
- side-cutting pliers, 180 mm (40580L)



Description

Part no.

2-piece

Z1125

## Pipe wrench set

CrV YYY

- chrome-vanadium
- with integrated industry and clamp protection



① highly resilient

Description

Part no.

3-piece, 175 + 240 + 300 mm long

41903L

## Pipe wrench set

CrV YYY

forged, with "S"-jaws, powerful hold and slip-off protection thanks to 3-point grip, painted blue, jaws polished

- 1-1,5-2 inch



Description

Part no.

3-piece

42250L

## Precision mechanic's tool set

YYY

in case

- universal pliers 120 mm
- side-cutting pliers 115 mm
- long-nosed pliers bent 125 mm
- long-nosed pliers straight 130 mm
- 3 electronic plain slot screwdrivers 2 - 2.5 - 3 x 50 mm
- 3 electronic cross-slot screwdrivers sizes 00 - 0 - 1 x 50 mm



Description

Part no.

10-piece

40706L

## Circlip pliers set, Extra short

4-piece set for inner and outer circlips. Insulated handles, for small circlips.

- tip diameter: 1 mm
- inner and outer circlips
- straight and bent



Description	Length	Part no.
4-piece	75 mm	41470L

## Circlip pliers set

forged, chrome-plated, handles rough foam-insulated, 150 mm long

- inner, straight, 27-3 mm
- inner, bent, 27-3 mm
- outer, straight, 4-29 mm
- outer, bent, 4-29 mm

① 1.5 mm tip



Description	Length	Part no.
4-piece	150 mm	41405L

## Circlip pliers set

forged, chrome-plated, handles rough foam-insulated, 175 mm long

- Inner, straight, 32-3 mm
- inner, bent, 27-3 mm
- outer, straight, 4-33 mm
- outer, bent, 4-29 mm

① 2.0 mm tip



Description	Length	Part no.
4-piece	175 mm	41410L

## Circlip pliers set

forged, handles rough foam-insulated, 225 mm long, in artificial leather case

- inner, straight, 42-4,5 mm
- inner, bent, 39-4 mm
- outer, straight, 4-32 mm
- outer, bent, 4-35 mm

① 2,5 mm tip



Description	Length	Part no.
4-piece	225 mm	41415L

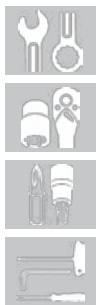

## Nose pliers set, Extra long



Straight, 45° angled + 90° angled



Description  
3-piece

Part no.  
40710L

## Gripping pliers set



with non-slip handles

- 2 universal-gripping pliers, 130 mm
- 3 universal-gripping pliers, 180 mm
- 5 universal-gripping pliers, 225 mm
- 1 langbeck locking pliers, 160 mm
- 1 langbeck locking pliers, 225 mm
- 2 spot welding locking pliers, 280 mm
- 2 welder's locking pliers, 225 mm



Description  
16-piece

Part no.  
41560L

## Special grip set



With snap release.

- for welding and clamping work on door openings, wheel arches, side walls, folding plates and also U-profiles etc.
- as mounting aid on doors, wheel arches and many other places



Description  
5-piece

Part no.  
41561L

## Water pump pliers

### Water pump pliers



**Racing Experience**, pushbutton adjustment with fine pitch. Inverted safety box joint with wide guide faces, anti-pinch protection for safe work in any position. High-grade tempering, teeth additionally inductively hardened. Titanium finish, 2-component handle sleeve



Length  
240 mm

Part no.  
41935L

## Water pump pliers

CrV YYY

- with box-joint precision design
- ergonomic insulated handles
- chrome-vanadium



Length  
250 mm

Part no.  
41965L

## Water pump pliers

DIN YYY

- tested according to DIN EN/IEC 60900
- 2-component handle sleeves
- 1000V



Length  
240 mm

Part no.  
41905L

## One-hand water pump plier

CrVs2 YYY

With patented automatic adjustment for a perfect hand-grip and single-handed operation! Box-joint design & pinch protection for safe use. Has special jaw shape, making it perfectly suitable for pipes as well as for nuts and screws.



ⓘ Automatic clamping on all parts.

Length  
240 mm

Part no.  
42124L

## Water pump pliers

DIN CrV YYY

for easy and safe work, DIN ISO 8976.

- Pressure head adjustment, quick and accurate
- Inverted through-inserted safety joint with broad guide surfaces
- Anti-trap guard in each setting
- Micro-surface finishing for smooth adjustments
- Double-locking gripper jaws
- Teeth with additional inductive hardening
- High-grade annealing
- Chrome-vanadium steel, die-forged and oil-hardened
- Titanium finishing
- Dip-insulated grips

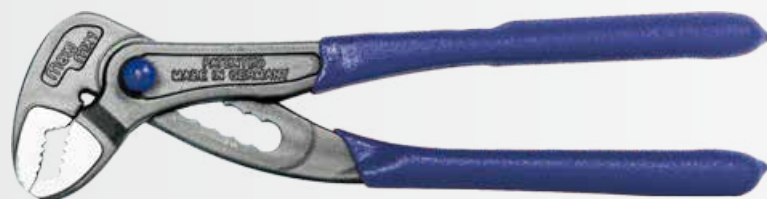

Description  
max. jaw width 50 - 180 mm

Length  
180 mm

Part no.  
41718L





## Water pump pliers



with automatic jaw width adjustment.

- Fine adjustments by drag & drop
- Inverted through-inserted safety joint with broad guide surfaces
- Anti-trap guard in each setting
- Double-locking gripper jaws
- Anti-trap guard for safe work in any position
- Teeth with additional inductive hardening
- High-grade annealing
- Chrome-vanadium steel, die-forged and oil-hardened
- Titanium finishing
- Dip-insulated grips



Description	Length	Part no.
max. jaw width: 50 mm	250 mm	41725L
max. jaw width: 75 mm	320 mm	41732L
max. jaw width: 100 mm	400 mm	41740L

## Water pump pliers



with box-joint design and pinch protection



Length	Part no.
240 mm	41900L

## Pipe wrench set



- chrome-vanadium
- with integrated industry and clamp protection



① highly resilient

Description	Part no.
3-piece, 175 + 240 + 300 mm long	41903L

## Water pump pliers



Chrome-vanadium, with through-inserted articulation and anti-trap guard



① highly resilient- new quality!

Length	Part no.
175 mm	41917L
240 mm	41924L
300 mm	41930L

## Water pump pliers



- chrome-vanadium
- with integrated industry and clamp protection



Length	Part no.
175 mm	41950L
300 mm	41970L



## Power combined pliers

DIN 111

### Racing Experience

- burner hole shaped as multi-purpose ring spanner up to ca. SW 18 mm
- titanium finish
- 2-component handle sleeve



Length

180 mm

Part no.

40460L

## Ergo combination pliers

111

### Racing Experience

- lever transmission
- inductively hardened cutting edge
- suitable for hard and soft wires or cables
- gripping zone for flat and round profile
- burner hole shaped as multi-purpose ring spanner up to ca. SW 18 mm
- with opening spring
- lockable
- titanium finish
- 2-component handle sleeve



Description

angled 45°

Part no.

40410L

## Universal pliers

DIN 111

- with burner hole
- with ergonomic insulated handles



Length

180 mm

Part no.

40450L

## Universal pliers

DIN 111

- tested according to DIN EN/IEC 60900
- with 2-component handle sleeves
- 1000V



Length

180 mm

Part no.

40405L

## Side cutter

### Side cutter

DIN 111

### Racing Experience

- titanium finish surface
- dual-component handle



Length

160 mm

180 mm

Part no.

40535L

40537L





## Lever-force side-cutting pliers

DIN ȳȳȳ

### Racing Experience

- inductively hardened precision cutting edge
- enormous cutting force, 40% force saved thanks to special leverage
- special tool steel, drop-forged, oil-hardened
- titanium finish, 2-component handle sleeve

### Cutting values:

- Piano wire - 2300 N/mm<sup>2</sup> - 3.0 mm
- Hard wire - 1800 N/mm<sup>2</sup> - 3.5 mm
- Medium-hard wire - 750 N/mm<sup>2</sup> - 4.5mm



Length  
200 mm

Part no.  
40536L

## Side-cutting pliers

DIN ȳȳȳ

- with strong insulated handles



Length  
160 mm  
180 mm

Part no.  
40550L  
40580L

## Heavy-duty side-cutting pliers, Extra long

DIN ȳȳȳ

with strong handle insulation and extra-long lever for the powerful cutting of all wires including piano wire up to approx. 3 mm diameter

① Extra long



Length  
255 mm

Part no.  
40560L

## Side-cutting pliers

DIN ȳȳȳ

- tested according to DIN EN/IEC 60900
- with 2-component handle sleeves
- 1000V



Length  
165 mm

Part no.  
40505L

# Nose Pliers

## Nose pliers

ȳȳȳ

### Racing Experience

- long, flat-round jaws
- toothed gripping face
- for hard and soft wires
- burner hole shaped as multi-purpose ring spanner up to ca. SW 15 mm
- titanium finish
- 2-component handle sleeve



Description	Length	Part no.
Straight Version	200 mm	40735L
Bent Version 45°	200 mm	40736L

## Nose pliers

DIN

with strong insulated handles



Description	Length	Part no.
Straight	160 mm	40740L
Straight	200 mm	40750L
Bent	200 mm	40755L

## Nose pliers set, Extra long

Straight, 45° angled and 90° angled



Description	Part no.
3-piece	40710L

## Nose pliers, Extra long

extra long version



Head version	Length	Part no.
Straight	310 mm	40710L-1
45° angled	310 mm	40710L-2
90° angled	310 mm	40710L-3

## Scissor-type jointed pliers, Extra long

for spots that are difficult to access, e.g. behind the interior trim, dashboard, engine compartment etc.

- Thanks to the double joint, the pliers remain slim even when fully opened, extending their working length for use in much deeper spots



Head version	Length	Part no.
Straight	350 mm	40711L
45° angled	350 mm	40712L

# Carpenters Pincers

## Carpenters Pincers

DIN

according to DIN 9243A



Length	Part no.
180 mm	40120L
200 mm	40130L





## Tower pincers

DIN 111

according to DIN ISO 9242A



### Length

220 mm

250 mm

### Part no.

40210L

40220L

# Pipe Wrench

## Pipe wrench set

CrV 111

forged, with "S"-jaws, powerful hold and slip-off protection thanks to 3-point grip, painted blue, jaws polished

- 1-1,5-2 inch



### Description

3-piece

### Part no.

42250L

## Pipe wrench

CrV 111

- forged, with "S"-jaws
- powerful hold and slip-off protection thanks to 3-point grip,
- painted blue
- jaws polished



### Description

1,0 inch

1,5 inch

2,0 inch

### Length

335 mm

420 mm

525 mm

### Part no.

42210L

42220L

42230L

# Bolt cutters

## Bolt cutter

111

handles made of steel tube, with adjustable blades, with rubber grips



### Description

Max. 6 mm Ø

Max. 8 mm Ø

Max. 10 mm Ø

Max. 12 mm Ø

### Length

465 mm

620 mm

750 mm

920 mm

### Part no.

45050L

45060L

45070L

45080L

## Gripping pliers set



with non-slip handles

- 2 universal-gripping pliers, 130 mm
- 3 universal-gripping pliers, 180 mm
- 5 universal-gripping pliers, 225 mm
- 1 langbeck locking pliers, 160 mm
- 1 langbeck locking pliers, 225 mm
- 2 spot welding locking pliers, 280 mm
- 2 welder's locking pliers, 225 mm

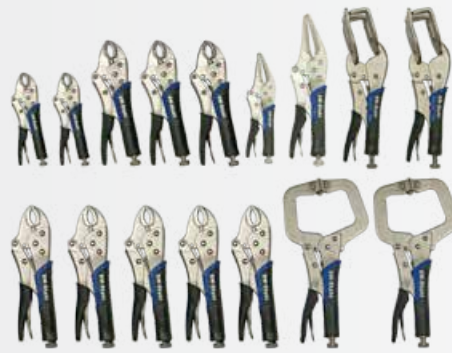

Description

16-piece

Part no.

41560L

## Special grip set



With snap release.

- for welding and clamping work on door openings, wheel arches, side walls, folding plates and also U-profiles etc.
- as mounting aid on doors, wheel arches and many other places



Description

5-piece

Part no.

41561L

## Automatic gripping pliers



with quick-action adjustment

- can be used without any pre-adjustment
- infinite adjustment of the clamping force independent of the workpiece
- simple and injury-free release
- high-strength version

ⓘ **One-handed operation possible!**



Length

150 mm

250 mm

Part no.

41551L

41552L

## Locking pliers



with forged jaws, with wire cutter



Length

250 mm

Part no.

41500L

## Locking pliers, Extra short



mini, universal version, semi-circular jaws, chrome-plated, 6 rivets



Length

100 mm

Part no.

41501L





## Locking pliers



with forged jaws, with wire cutter, adjustable, lever insulated with vinyl

- clamping range up to 32 mm



**Length**  
250 mm

**Part no.**  
41502L

## Locking pliers



Special steel, 3-fold adjustment, can be clamped up to 55 mm



**Length**  
250 mm

**Part no.**  
41505L

## Langbeck Locking pliers



with extremely narrow bit for spots that are difficult to access



**Length**  
170 mm  
225 mm

**Part no.**  
41520L  
41521L

## Spot welding locking pliers



forged

- side length: 80 mm
- max opening width: 80 mm



**Length**  
280 mm  
460 mm

**Part no.**  
41515L  
41516L

# Rivet Pliers

## Shear rivet tool



for aluminium and steel rivets and rivet nuts, with many accessories, an absolute must for working on riveted window lifters

- pads 3.2 - 4.0 - 4.8 - 5.0 - 6.4 mm
- rivet nuts M4 - 5 - 6 - 8 - 10
- handles can be unfolded to 500 mm
- little force required



**Length**  
500 mm

**Part no.**  
42760L

## Blind rivet pliers

for aluminium work, with replaceable nosepieces

- 2.4 - 3.0 - 4.0 - 4.8 mm



Length

250 mm

Part no.

42700SB

## Professional blind rivet pliers

profi version, for aluminium rivets, with replaceable nosepieces

- 2,4 - 3,0 - 4,0 - 4,8 mm



Length

250 mm

Part no.

42710L

## Blind rivet pliers

head can be turned through 360°, for aluminium rivets, with 4 replaceable nosepieces

- 2.4 - 3.0 - 4.0 - 4.8 mm



Length

250 mm

Part no.

42750L

## Blind rivet pliers set

box with pliers and 100 different blind rivets

- with four replaceable heads
- for blind rivets 2.4 - 3.0 - 4.0 - 4.8 mm
- incl. 100 blind rivets (25 per size)



Length

250 mm

Part no.

42800L

## Plastic rivet gun set

for the fast and professional riveting of wheel housing, sill and interior panelling as well as dashboards e.g. on the BMW X3, X5, X6 / Chrysler / Ford / Jaguar / Saab etc.

Contains the following sizes:

- 10 pieces in Ø 5.0 mm x 15.8 mm
- 10 pieces in Ø 5.0 mm x 17.2 mm
- 10 pieces in Ø 6.6 mm x 17.2 mm
- 10 pieces in Ø 6.3 mm x 25.2 mm
- incl. 1 rivet gun for plastic rivets



BMW  
Chrysler  
Ford  
Jaguar  
Saab

Description

41-piece

10 pieces in Ø 5,0 mm x 15,8 mm

10 pieces in Ø 5,0 mm x 17,2 mm

10 pieces in Ø 6,6 mm x 17,2 mm

10 pieces in Ø 6,3 mm x 25,2 mm

Part no.

42761L

42761L-1

42761L-2

42761L-3

42761L-4



## Electronics side-cutting pliers



### Racing Experience

- with oval head
- 2-component soft-grip ESD handle sleeve grey/black
- drop-forged, made of high-quality tool steel with bevel
- sturdy and durable for hard and soft wires



**Length**  
125 mm

**Part no.**  
40590L

## Electronics taper tap



### Racing Experience

- with wide head and long cutting edges
- with 2-component soft-grip ESD handle sleeve grey/black
- drop-forged, made of high-quality tool steel with fine bevel
- sturdy and durable for hard and soft wires



**Length**  
125 mm

**Part no.**  
40591L

## Electronics long-nosed pliers



### Racing Experience

- short jaws
- with 2-component soft-grip ESD handle sleeve grey/black
- drop-forged, made of high-quality tool steel without blow to protect components and wires
- sturdy and durable



Description	Length	Part no.
Straight version	130 mm	40790L
bent version 45°	130 mm	40791L

## Stripping pliers



self-adjusting 0.2 - 6 mm<sup>2</sup>, with wire cutter

- ideal for doubly insulated cables
- separates insulation in the middle of a cable too, to solder branches
- for pressing insulated or non-insulated cable lugs and ignition plugs



ⓘ **Self-adjusting**

**Length**  
210 mm

**Part no.**  
42410SB

## Cable stripping tongs



self-adjusting for cables 0.2-6 mm<sup>2</sup>

- with adjustable length stop for insulation stripping 8-12 mm
- cable cutter up to 2 mm diameter
- determination for space-efficient retention and care of the cutting blades



ⓘ **Self-adjusting**

**Part no.**  
42420L



## Cable lug gripper

- especially for insulated ties 1.5 - 2.5 - 6.0 mm
- stripping: 0.75 - 1.0 - 1.5 - 2.5 - 4.0 - 6.0 mm
- screw cutter M2.6 - M3 - M3.5 - M4 - M5



Part no.  
**42500L**

## Cable lug gripper

- especially for **non-insulated** ties 1.5 - 2.5 - 6.0 mm
- stripping: 0.75 - 1.0 - 1.5 - 2.5 - 4.0 - 6.0 mm
- screw cutter M2.6 - M3 - M3.5 - M4 - M5



Part no.  
**42501L**

## Cable lug gripper

- for insulated and **non-insulated** ties 1.5 - 2.5 - 6.0 mm
- stripping: 0.75 - 1.0 - 1.5 - 2.5 - 4.0 - 6.0 mm
- screw cutter M2.6 - M3 - M3.5 - M4 - M5



Part no.  
**42504L**

## Cable lug gripper

professional - with leverage and forced lock



### Description

- for insulatet ties 0,5 - 6 mm<sup>2</sup>
- for non-insulatet ties 0,5 - 6 mm<sup>2</sup>
- Pair of spare jaws for 42565L

Part no.  
**42550SB**  
**42565SB**  
**42566L**

## Cable lug gripper

with replaceable mouthpieces, forced lock, 2-K insulated handle, in plastic box

- jaw A: for insulated cable lugs from 0.5 - 6.0 mm<sup>2</sup> (red, blue, yellow)
- jaw B: for closed, non-insulated cable lugs from 0.5 - 10.0 mm
- jaw C: for open, non-insulated cable lugs from 0.5 - 6.0 mm, up to 6.3 mm width
- jaw D: for cable end sleeves with and without collar from 0.5 - 4.0 mm
- jaw F: for cable end sleeves over 4.0 mm



### Description

- 6-piece
- Pair of replacement jaws A
- Pair of replacement jaws B
- Pair of replacement jaws C
- Pair of replacement jaws D
- Pair of replacement jaws F

Part no.  
**42585L**  
**42585L-A**  
**42585L-B**  
**42585L-C**  
**42585L-D**  
**42585L-F**





## Pair of additional jaws



for cable lug gripper 42585L

- Jaw H: for crimp connectors with cable cross-section 0.5 mm<sup>2</sup> / 2.5 mm<sup>2</sup> / 8-10 mm<sup>2</sup> e.g. for Japanese motorcycles (Honda, Kawasaki, Yamaha, etc.)



**Description**  
Pair of jaws H

**Part no.**  
42585L-H



## Pair of additional jaws



for cable lug gripper 42585L

- jaw E: for BNC/TNC coaxial plug RG58, RG59, RG62 with hexagonal fit



**Description**  
Pair of jaws E

**Part no.**  
42585L-E



## Cable lug gripper



for cable end sleeves, forged, with spring and handle protection

- for sleeves 0.5 - 0.75 - 1.0 - 1.5 - 2.5 mm<sup>2</sup>



**Length**  
150 mm

**Part no.**  
42520L



## Other Pliers

### Circlip pliers set, Extra short



- Insulated handles, for small circlips.
- tip diameter: 1 mm
- inner and outer circlips
- straight and bent



**Description**  
4-piece

**Length**  
75 mm

**Part no.**  
41470L



## Circlip pliers set

forged, chrome-plated, handles rough foam-insulated, 150 mm long

- inner, straight, 27-3 mm
- inner, bent, 27-3 mm
- outer, straight, 4-29 mm
- outer, bent, 4-29 mm

① 1.5 mm tip

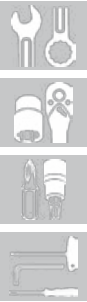

Description	Length	Part no.
4-piece	150 mm	41405L

## Circlip pliers set

forged, chrome-plated, handles rough foam-insulated, 175 mm long

- Inner, straight, 32-3 mm
- inner, bent, 27-3 mm
- outer, straight, 4-33 mm
- outer, bent, 4-29 mm

① 2.0 mm tips



Description	Length	Part no.
4-piece	175 mm	41410L

## Circlip pliers set

forged, handles rough foam-insulated, 225 mm long, in artificial leather case

- inner, straight, 42-4,5 mm
- inner, bent, 39-4 mm
- outer, straight, 4-32 mm
- outer, bent, 4-35 mm

① 2.5 mm tips



Description	Length	Part no.
4-piece	225 mm	41415L

## Circlip pliers set, Extra long

maxi, for inner and outer circlips, lockable, exchangeable tips

straight - 45° - 90°  
max. spread 85 mm

① 3.0 mm tips



Length	Part no.
440 mm	41416L





## Circlip pliers



for wheel bearing circlips according to DIN 472 and 984, max tip diameter according to DIN 5256: 2.3 mm, for bore diameters of 40 - 100 mm, anti-slip handle.

The 45° angle of the tips enables precise work. Two available sizes cover all standard ranges of circlips used on wheel bearings.



Description	Length	Part no.
Size 2 / 40-100 mm	220 mm	41310L
Size 3 / 85 - 140 mm	330 mm	41315L

## Circlip pliers, switchable



These circlip pliers are switchable and can work with inner- and outer circlips. One pliers for all circlips. Additional straight and bent tips are enclosed. They interchangeable fast and easily. The pliers are suitable for circlips between 8 mm and 48 mm.



Description	Part no.
Circlip pliers	41360L
Replacement tips	41360L-1

## Circlip pliers



according to DIN, forged, chrome-plated

- sturdy shape
- non-slip precision tips
- Titan finish
- insulated handles
- for circlips 19 - 60 mm



ⓘ 1,7 mm tips Ø

Description	Head version	Length	Part no.
Outer circlip straight	straight	180 mm	41301L
Outer circlip bent	bent	170 mm	41302L
Inner circlip straight	straight	180 mm	41401L
Inner circlip bent	bent	170 mm	41402L

## Padded pliers set



for professional attachment of the seat covers to the upholstery, e.g.

- when replacing the seat covers or the upholstery
- when replacing the airbag sensor mat (passenger seat)
- when replacing the underseat heating mat



ⓘ Incl. 100 clamps

Description	Part no.
Padded pliers set	94808L
100 replacement clamps	94808L-1

## Spark plug connector pliers

with strong insulated handles. Also suitable for pulling off injection lines



**Description**

Normal shape

**Length**

200 mm

**Part no.**

402001

## Spark plug connector pliers

for extremely deep-seated spark plugs on multivalve engines. The gripping surface is calibrated for the safe gripping of the plug connector



Mercedes-Benz  
Suzuki

**Length**

290 mm

**Part no.**

402006SB

## Glow plug pliers

For removing and installing difficult to access glow plug sockets in modern diesel engines, e.g. from Audi, BMW, Mercedes, VW



Mercedes-Benz  
BMW  
Audi  
VW

**Description**

Straight version

**Length**

240 mm

**Part no.**

402002

Bent version

240 mm

402003

## Valve sealing ring pliers

For removing the valve stem gaskets.



**Length**

250 mm

**Part no.**

08510L

## Fuel Hose Clip Loosening Pliers

for removal and replacement of hose clips connections on in-line fuel filters, e.g. for VW, Audi, Fiat, Mercedes-Benz, Opel.

With the pliers, the locking can be pushed forward (lock) and backwards (unlock).



Opel  
Audi  
Fiat  
Mercedes-Benz  
General Motors  
VW

**Part no.**

61708L

## Fuel line detaching pliers

For loosening plug-in connectors with snap-in pins.

- ideal for changing fuel filters
- 90° angled – therefore well suited for tight working conditions
- e.g. for Alfa, Audi, Fiat, Lancia, Volvo, VW etc.



Alfa Romeo  
Audi  
Fiat  
Lancia  
Volvo  
VW

**Length**

210 mm

**Part no.**

61718L



## Pliers set

for loosening fuel line connectors on VAG, Fiat, Ford, Opel, Peugeot, Renault and Citroën



**YYY**  
Audi  
Citroën  
Fiat  
Ford  
Opel  
Peugeot  
Renault  
Seat  
Škoda  
VW

**Description**  
3-piece

**Part no.**  
61715L

## CLIC hose clamping pliers

- with rotatable and angled jaws
- for loosening and closing the CLIC and CLIC-R clamps on fuel lines, drive shafts, etc.
- length 190 mm



**YYY**  
Audi  
Citroën  
Fiat  
Mercedes-Benz  
Opel  
Peugeot  
Renault  
Seat  
Škoda  
VW

**Length**  
190 mm

**Part no.**  
45000L

## Spring clip pliers

- with hardened jaws
- For fitting and removing small spring clips with three ends e.g. on fuel and tank bleeding pipes on Audi, VW, Seat, Škoda vehicles etc.



**YYY**  
Audi  
Seat  
Škoda  
VW

**Description**  
Clamping range up to 28 mm

**Length**  
192 mm

**Part no.**  
45001L

## Band-type clamp pliers

for self-clamping spring clamps from 18 – 54 mm on fuel and coolant hoses.

- with bowden cable, suitable for all installation spots which are difficult to access
- safe hold thanks to lever locking

e.g. for:

- Alfa, Audi, Citroën, Fiat, Ford, Hyundai, Lancia, MAN, Mercedes-Benz, Mini (BMW), Opel, Peugeot, Porsche, Renault, Seat, Toyota, VW, Volvo, etc



**YYY**  
Alfa Romeo  
Audi  
Citroën  
Fiat  
Ford  
Hyundai  
Lancia  
MAN  
Mercedes-Benz  
Mini  
Opel  
Peugeot  
Porsche  
Renault  
Seat  
Toyota  
Volvo  
VW

**Description**  
Band-type clamp pliers  
Replacement cable

**Length**  
630 mm  
630 mm

**Part no.**  
61777L  
61777L-1

## Band-type clamp pliers

with bowden cables for flat and normal clamps, patented, suitable for all installation spots. Clamps can no longer slip thanks to the special seats. With new clamp systems, only the bowden cable has to be replaced, the expensive purchase of new pliers is no longer necessary

① infinitely adjustable

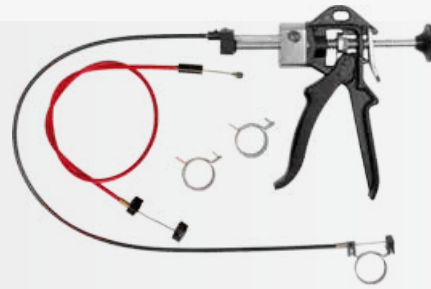

Description	Part no.
Pliers with Bowden cables	61771L
Standard cable for normal clamps (black)	61773L
Standard cable for flat clamps (red)	61774L
Additional cable for MAO clamps (blue)	61776L

## Band-type clamp pliers

for spring-loaded band-type clamps, clamp seat can be turned



Description	Length	Part no.
Straight model	200 mm	61760L

## Band-type clamp pliers

for spring-loaded band-type clamps, clamp seat can be turned



Description	Length	Part no.
angled model	240 mm	61765L

## BMW pipe separating pliers

Screwed clamping pliers (15 and 22 mm). Pliers can be spread in 5 settings by grooved box-joint, works similar to water pump pliers.

For removing pipes on the gear-oil cooler (automatic gearbox)

for BMW:

- 1 - E81, 82, 87, 88
- 3 - E46, 90, 91, 92, 93
- 5 - E60, 61
- 6 - E64, 63
- 7 - E65, 66
- X3 - E83
- X5 - E53, 70
- X6 - E71
- Z4/Coupé - E85, 86
- Mini R50, 52, 53

BMW OE No. 170030



BMW

Part no.
08446L





## Safety tongs for exhaust clamps

- for widening and holding the exhaust clamps open during exhaust replacement
- Suitable for e.g.: Citroën, Peugeot and Renault
- 4 locking positions to relieve the strain on the hand
- clamps from 20 - 60 mm



Citroën  
Peugeot  
Renault

Length  
300 mm

Part no.  
26005L



## Squeeze out pliers

for exhaust suspensions.

- for easier dismantling of exhaust suspensions.
- 25° opening angle for sufficient space



Length  
285 mm

Part no.  
26003L



## Ejector tool for exhaust rubbers

large version

- makes it easier to remove suspension rubbers
- sufficient space thanks to 25° opening angle
- with self-centring pressure pin
- suitable for small delivery trucks and large passenger cars



Length  
360 mm

Part no.  
26004L



## Plate bending and edging pliers

To bend metal plates at various angles

- length 280 mm
- width approx. 62 mm
- max opening approx. 60 mm
- high-quality/heavy design
- dip-insulated grips



### Kopf-Ausführung

Straight  
45° angled  
90° angled

Part no.  
92520L  
92521L  
92522L



## CV boot pliers

for infinite and earless clamps on radiators, fuel hoses, air filter housings on the Opel Astra as well as CV boots on new VW and Mercedes-Benz types



Audi  
Seat  
Škoda  
VW  
Mercedes-Benz  
Opel

Length  
235 mm

Part no.  
41460L





## CV boot pliers

with blank holder, prevents the boots closure/becoming loose, for universal use e.g. for VAG, Opel, BMW, Mercedes-Benz, Honda, Nissan, Mazda etc. e.g. during work on the fuel filters and water pump.

① With additional square 12,5 mm (1/2")

Length  
235 mm

Part no.  
61790L



Mazda  
Honda  
BMW  
Audi  
Mercedes-Benz  
Nissan  
Opel  
Seat  
Škoda  
VW



## CV boot pliers

for attaching the lug clamps (Oetiker system).  
For use at the side where space is tight e.g. on CV boots, radiator and fuel hoses etc.

Length  
245 mm

Part no.  
61791L



## CV boot pliers

for axle tubes without steps or lugs, e.g. for VAG, BMW, Mercedes-Benz and Toyota.

Length  
245 mm

Part no.  
41461L



BMW  
Audi  
Mercedes-Benz  
Škoda  
Toyota



## Universal balance weight pliers

for loosening weights on rims

- chromed
- length 245 mm
- handles isolated

Length  
245 mm

Part no.  
41440L



## Balancing weight pliers

The adhesive weight tongs are a release forceps for glued balancing weights.

- includes an integrated spring
- prevents the scratching of the aluminium rims during peeling

Length  
245 mm

Part no.  
41442L





## Drum Brake spring pliers



Ideal for the quick and easy removal and assembly of the brake shoes from the drum brakes. Universal for all standard spring plates of 7 - 30 mm diameter. Due to the angled shape also suitable for hard-to-reach places. Length 180 mm.



Length  
180 mm

Part no.  
01476L



## Brake spring pliers



with movable claw for riveted and glued pads

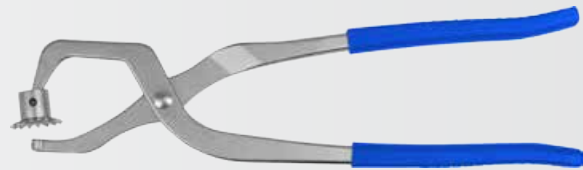

Length  
317 mm

Part no.  
40810L

## Brake spring pliers



For removing and installing the brake drum spring, for both glued and riveted linings



① Extra heavy duty

Length  
500 mm

Part no.  
40811L



# OTHER HAND TOOLS





# OTHER HAND TOOLS

# 180-237



▶ Measuring Tools	182-184
▶ Cutting Tools	185-188
▶ Drill and Mill Tools	188-197
▶ Thread Tapping Tools	198-205
▶ Thread Repair Tools	205-211
▶ Pick and Hook Sets	212-214
▶ Brushes / Files / Polishing	215-218
▶ Hammers / Chisels / Punches	218-225
▶ Cotter Pin Drives / Pin Punches / Scribing Tools	225-228
▶ Bar Clamps	228
▶ Grease Guns / Cartridge Press	228-231
▶ Pullers	231-236





## Precision calliper gauge



stainless, for outer, inner and depth measurement, 200 mm measuring range shown in millimetres and inches, nonius 1/20 mm



Measuring range  
200 mm

Part no.  
72301L

## Calliper gauge



stainless, with depth measurement, 150 mm measuring range, in case



Description  
Measuring range 0 - 150 mm

Part no.  
72300SB

## Digital caliper gauge



stainless, in a box.

- with depth measurement
- 150 mm measuring range
- with mm/inch scale, indicating nonius 1/100 mm
- adjustable 0-position and mm/Inch setting
- + / - display
- inc. battery



Description  
Measuring range 0 - 150 mm  
Replacement battery

Part no.  
72350L  
72350L-Batt

## Digital brake disc caliper



Extra long and narrow design makes it possible to measure the brake disc even when the wheels are mounted.

- measuring range from 0 - 80 mm to 0 - 3.2"
- depth of the external measuring tongs 28 mm / 1.10"
- resolution 0,01 mm / 0,0005"
- accuracy  $\pm 0,025$  mm /  $\pm 0,001$ "
- LCD display
- stable, hardened stainless steel
- automatic shutdown
- incl. 3 Volt CR2032 battery



Description  
Measuring range 0 - 80 mm  
Replacement battery

Part no.  
72347L  
72350L-Batt

## Brake disc gauge



servicing specifications state that the thickness of the brake discs is decisive as to whether they have to be replaced or not.

In addition, discs of different thicknesses have been fitted in some vehicles e.g. VW Lupo within one model series. This means that the thickness has to be measured to establish whether or not the correct disc is fitted



Description  
Measuring range 0 - 60 mm

Part no.  
72345L

## Brake gauge

suitable for brake discs and drums from 160 to 360 mm in diameter



### Description

Measuring range 160 - 360 mm

### Part no.

72340L

## Outside micrometer

ideal for measuring e.g. valve setting shims, wear on brake discs, camshafts etc.

- scale division 0.01 mm
- gradient per revolution 0.5 mm
- measuring areas hardened
- with clamping lever and ratchet stop
- including hook wrench



### Description

Measuring range 0 - 25 mm

### Part no.

72351L

## Precision gauge

from diesel special tool set 26060L



### Part no.

26067L

## Flexible magnetic base holder

flexible, for gauge or other measuring instruments

- Thanks to the prism base which can be switched on and off, the bracket holds perfectly to struts, which are not made of alloy material
- For versatile adjustment including precision setting
- Ideal for testing the brake discs and wheel hubs for axial run-out

① Can be used with 26067L precision gauge!



### Description

holder

### Part no.

07354L

Gauge

26067L

## Valve gauge

in nickle-plated cover holder



### Description

0,05 - 1,00 mm / 13 gauges

### Part no.

09102L

0,05 - 1,00 mm / 20 gauges

09103L



## Valve gauge



21 blades, conical

- 0.10 - 0.12 - 0.14 - 0.16 - 0.18 - 0.20 - 0.22 - 0.24 - 0.26 - 0.28 - 0.30 - 0.32 - 0.34 - 0.36 - 0.38 - 0.40 - 0.42 - 0.44 - 0.46 - 0.48 - 0.50 mm



**Description**  
0,10 - 0,50 mm / 21 gauges

**Part no.**  
**09104L**

## Tape measure



with plastic housing, with stopper  
indication in metric and inch measurements.



**Description**  
2 m long

**Part no.**  
**72000L**

## Tape measure



with plastic housing, with stopper



**Description**  
5 m long, tape 25 mm wide

**Part no.**  
**72200L**

## Tape measure



in plastic housing, with stopper and belt clip



**Description**  
8 m long, tape 25 mm wide

**Part no.**  
**72050L**

## Folding wooden yardstick



with spring, 2 m long

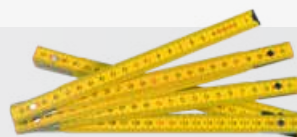

**Description**  
Standard model

**Part no.**  
**72400L**

## Folding wooden yardstick



with spring, 2 m long



**Description**  
Industrial quality

**Part no.**  
**72410L**

## Aluminium spirit level



with 3 bubble levels

- horizontal 180°
- vertical 45° and 90°



**Description**  
400 mm

**Length**  
400 mm

**Part no.**  
**72405L**



## Knife set with break-off blades

made of plastic, with one 18 mm and two 9 mm knives

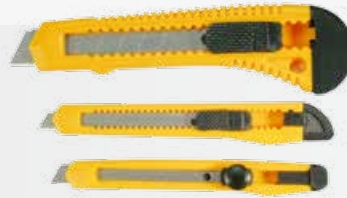

**Description**  
3-piece

**Part no.**  
90605SB

## Knife with break-off blade

made of plastic



**Description**  
with 18 mm blade  
with 9 mm blade

**Part no.**  
90610L  
90615L

## Knife with break-off blade

with automatic blade locking and blade magazine.  
The used blades are pushed out of the front and the following blade can be used



① With 6 replacement blades in the magazine

**Description**  
Knife inc. blades, 18 mm width

**Part no.**  
90670SB

## Professional knife with break-off blade

heavy-duty version with cast zinc housing and 18 mm wide blade in metal blade guide. Safe grip thanks to rubber non-slip protection on the back.



**Part no.**  
90690SB

## Knife with break-off blade

with metal blade guide and sturdy housing



**Description**  
with 18 mm blade

**Part no.**  
90645L

## Knife with break-off blade

with metal blade guide and sturdy housing



**Description**  
with 9 mm blade

**Part no.**  
90640L





## Replacement break-off blades



in plastic case



Description	Part no.
10 units, 18 mm wide	90620L
10 units, 9 mm wide	90630L

## Jackknife



with trapezoidal blade, 153 mm long (extended)  
Particularly handy, high cutting performance



① Foldable

Description	Part no.
Knife with 5 blades	90665L
5 top-quality replacement blades	90666L

## Safety knife



professional with automatic blade retraction

- suitable for trapezoidal and hook blades
- heavy-duty version with cast zinc housing
- ergonomically shaped soft-touch handle
- integrated storage compartment for 5 replacement blades
- metal blade guide



Description	Length	Part no.
Safety knife	250 mm	90661L
5 top-quality replacement blades		90666L

## Universal scissors



with ergonomic 2-component handle, blades made of stainless steel, one blade with fine teeth.  
With spring, safety catch and stripping recess.  
Suitable for paper, cardboard, rubber, foils and many other applications.



Part no.  
S2050

## Pipe and hose cutter



for separating plastic pipes made of polypropylene and polyethylene,  
with lever transmission for pipes from 5 - 40 mm diameter



Part no.  
S1902

## Hose cutter



with stainless steel blade in plastic housing. Suitable  
for hose diameters from 4 - 16 mm



Part no.  
S1912

## Sheet shears

lever transmission, industrial quality, toothed, inductively hardened cutting edges



Description	Length	Part no.
Right-hand cut	260 mm	92710L
Left-hand cut	260 mm	92720L

## Household saw

made of steel wire with metal sawblade



Description	Part no.
For 150 mm spare blades	71500L

## Household saw

with wooden handle and metal sawblade



Description	Part no.
For 150 mm spare blades	71700L

## Professional saw

with pistol handle and extremely pointed design for tight angles, with metal sawblade



Description	Part no.
For 150 mm spare blades	71705L

## Professional saw

profi-version, with pistol handle and extra high hoop for sawing objects with a large cross-section, with metal sawblade



Description	Part no.
For 150 mm spare blades	71710L

## Metal sawblades

12 units - 150 mm long



Length	Part no.
150 mm	71800L

## Metal saw

made of tubular steel, adjustable, with hoop handle, with metal sawblade



Description	Part no.
For 300 mm spare blades	70200L





## Professional saw



adjustable, with rubber handle, made of rectangular tube with metal sawblade



Description	Part no.
For 300 mm spare blades	70250L

## Metal sawblade



HSS Biflex high-performance blade, 24 teeth/inch

- Made in Germany



### 📌 New Quality

Description	Length	Part no.
HSS Biflex high-performance blade	300 mm	71600L
10 piece	300 mm	71650L

## Reciprocating saw blade



HSS, tooth pitch 1.4, for steel and stainless steel measuring 1.5 to 2.5 mm, milled and corrugated teeth, long-life design, made in Germany, pack of 5



Description	Part no.
5-piece, 150 x 19 x 0,9 mm	71615L
5-piece, 200 x 19 x 0,9 mm	71616L

# Drill and Mill Tools

## Range of thread and tap drills, M4 – M10



very handy combination range for drilling, cutting and counterboring the most common standard metric threads.

Contents:

- tap twist drill HSS-G DIN338:  $\varnothing$  3.3 mm,  $\varnothing$  4.2 mm,  $\varnothing$  5.0 mm,  $\varnothing$  6.8 mm,  $\varnothing$  8.5 mm
- thread tap form B DIN371 HSS-E (Co5): M4x0.7, M5x0.8, M6x1.0, M8x1.25, M10x1.5
- countersink 90° HSS DIN335C HSS,  $\varnothing$  10.4 mm,  $\varnothing$  16.5 mm
- handy plastic box with threaded cover.



Description	Part no.
12-piece	82229L

## Spiral drill set



HSS roll-milled, DIN 338, in round box

- 1 unit each 1.0 - 10.00 x 0.5 mm increasing



Description	Part no.
19-piece	80300L

## Spiral drill set

HSS in metal box

DIN HSSs YYY



Description	Part no.
19-piece, roll-milled 1 - 10 mm x 0.5 increasing	80419L
25-piece, roll-milled 1 - 13 mm x 0,5 increasing	80425L
Empty metal box for 19-piece set	80318L
Empty metal box for 25-piece set	80424L

## Spiral drill set

HSS roll-milled, DIN 338, in metal box

- 10 units each 1.0 - 8.0 x 0.5 mm increasing
- 5 units each 8.5 - 10.0 x 0.5 mm increasing

DIN HSSs YYY



Description	Part no.
170-piece	80200L

## Left-hand drill set

HSS ground (DIN 338)  
left-handed thread, for drilling out broken screw heads, threaded bolts etc.

- 3 - 4 - 5 - 6 - 7 mm

DIN HSSs YYY



ⓘ Left-handed thread!

Description	Part no.
5-piece	80505L

## Spiral drill set

HSS in metal box

HSSs YYY YYY



Description	Part no.
19-piece, ground, TITANIUM nitrified 1 - 10 mm x 0.5 increasing	80519L
25-piece, ground, TITANIUM nitrified 1 - 13 mm x 0,5 steigend	80525L
Empty metal box for 19-piece set	80318L
Empty metal box for 25-piece set	80424L



## Spiral drill set

DIN HSS YYY

HSS, ground, DIN 338, TITANIUM nitrified for long tool life, in metal box

- 10 units each 1.0 - 8.0 x 0.5 mm increasing
- 5 units each 8.5 - 10.0 x 0.5 mm steps



① Ground

Description	Part no.
170-piece	80210L

## Spiral drill set

DIN YYY

HSS, 5% cobalt alloy, drill manufactured according to DIN 338, in metal box

- Ground from solid material
- 10 units each 1.0 - 8.0 x 0.5 mm increasing
- 5 units each 8.5 - 10.0 x 0.5 mm increasing



① Ground

Description	Part no.
170-piece	80220L

## Spiral drill set

DIN HSS YYY

in metal box, HSS, **COBALT ALLOYED**, for maximum demands on service life and cutting ability. Also suitable for cutting high-alloy materials over 800 N/mm<sup>2</sup>, with crosswise grinding according to DIN 1412C, point angle of 135°.

Please heed the reference rotary speeds:

- 2 mm = ca. 1,300 rpm
- 5 mm = ca. 510 rpm
- 8 mm = ca. 210 rpm



Description	Part no.
25-piece, 1 - 13 mm x 0,5 increasing	80625L
19-piece, 1 - 10 mm x 0,5 increasing	80619L

## Spiral drill set

DIN YYY

HSS, **COBALT ALLOYED**, for maximum demands on service life and cutting ability. Also suitable for cutting high-alloy materials over 800 N/mm<sup>2</sup>, with crosswise grinding according to DIN 1412C, point angle of 135°. Packed in paper bags, please heed packaging units. Please heed the reference rotary speeds:

Please heed the reference rotary speeds:

- 2 mm = ca. 1,300 rpm
- 5 mm = ca. 510 rpm
- 8 mm = ca. 210 rpm

19-piece in patented box, 1.0 - 10 mm x 0.5 mm increasing



Description	Part no.
19-piece	80719L

## Spiral drill

DIN HSS YYY

DIN 338, roll-milled, in individual tear-off pockets with hook tag

- ① Up to 3.3 mm = 3 units
- Up to 5.0 mm = 2 units
- Up to 13.0 mm = 1 unit



Size	Length	Part no.
1,00 mm	34 mm	80010SB
1,50 mm	40 mm	80015SB
2,00 mm	48 mm	80020SB
2,50 mm	57 mm	80025SB
3,00 mm	63 mm	80030SB
3,20 mm	66 mm	80032SB
3,50 mm	71 mm	80035SB
4,00 mm	76 mm	80040SB
4,10 mm	76 mm	80041SB
4,20 mm	76 mm	80042SB
4,50 mm	82 mm	80045SB
4,80 mm	87 mm	80048SB
5,00 mm	87 mm	80050SB
5,50 mm	96 mm	80055SB
6,00 mm	96 mm	80060SB
6,50 mm	100 mm	80065SB
7,00 mm	110 mm	80070SB
7,50 mm	110 mm	80075SB
8,00 mm	112 mm	80080SB
8,50 mm	116 mm	80085SB
9,00 mm	125 mm	80090SB
9,50 mm	125 mm	80095SB
10,00 mm	130 mm	80100SB
10,50 mm	132 mm	80105SB
11,00 mm	140 mm	80110SB
11,50 mm	141 mm	80115SB
12,00 mm	150 mm	80120SB
12,50 mm	150 mm	80125SB
13,00 mm	150 mm	80130SB





## Spiral drill



HSS, ground, **TITANIUM nitrified**, 5 times the tool life, excellent dimensional stability



Size	Part no.
1,00 mm	TIN1,00
1,50 mm	TIN1,50
2,00 mm	TIN2,00
2,50 mm	TIN2,50
3,00 mm	TIN3,00
3,20 mm	TIN3,20
3,50 mm	TIN3,50
4,00 mm	TIN4,00
4,50 mm	TIN4,50
4,80 mm	TIN4,80
5,00 mm	TIN5,00
5,50 mm	TIN5,50
6,00 mm	TIN6,00
6,50 mm	TIN6,50
7,00 mm	TIN7,00
7,50 mm	TIN7,50
8,00 mm	TIN8,00
8,50 mm	TIN8,50
9,00 mm	TIN9,00
9,50 mm	TIN9,50
10,00 mm	TIN10,00
10,50 mm	TIN10,50
11,00 mm	TIN11,00
11,50 mm	TIN11,50
12,00 mm	TIN12,00
12,50 mm	TIN12,50
13,00 mm	TIN13,00





## Spiral drill

HSS YYY

HSS, **COBALT ALLOYED**, for maximum demands on service life and cutting ability. Also suitable for cutting high-alloy materials over 800 N/mm<sup>2</sup>, with crosswise grinding according to DIN 1412C, point angle of 135°.

Please heed the reference rotary speeds:

- 2 mm = approx. 1.300 U/min.
- 5 mm = approx. 510 U/min.
- 8 mm = approx. 210 U/min.



Size	Length	Part no.
1,00 mm	34 mm	KOB-1,00
1,50 mm	41 mm	KOB-1,50
2,00 mm	50 mm	KOB-2,00
2,50 mm	58 mm	KOB-2,50
3,00 mm	61 mm	KOB-3,00
3,30 mm	66 mm	KOB-3,30
3,50 mm	70 mm	KOB-3,50
4,00 mm	75 mm	KOB-4,00
4,20 mm	76 mm	KOB-4,20
4,50 mm	79 mm	KOB-4,50
5,00 mm	86 mm	KOB-5,00
5,50 mm	94 mm	KOB-5,50
6,00 mm	96 mm	KOB-6,00
6,30 mm	102 mm	KOB-6,30
6,50 mm	102 mm	KOB-6,50
7,00 mm	110 mm	KOB-7,00
7,50 mm	110 mm	KOB-7,50
8,00 mm	117 mm	KOB-8,00
8,50 mm	117 mm	KOB-8,50
8,80 mm	125 mm	KOB-8,80
9,00 mm	133 mm	KOB-9,00
9,50 mm	127 mm	KOB-9,50
10,00 mm	133 mm	KOB-10,00
10,50 mm	135 mm	KOB-10,50
11,00 mm	143 mm	KOB-11,00
11,50 mm	145 mm	KOB-11,50
12,00 mm	152 mm	KOB-12,00
12,50 mm	152 mm	KOB-12,50
13,00 mm	152 mm	KOB-13,00

## Spiral drill bit set

HSS 6.3 6.3 YYY

in patented folding box, HSS, ground, low risk of breakages, high dimensional stability

- 1 - 1,5 - 2 - 2,5 - 3 - 3,5 - 4 - 4,5 - 5 - 5,5 - 6 - 6,5 - 7 - 7,5 - 8 - 8,5 - 9 - 9,5 - 10 mm

6,3 mm (1/4") drive



Description	Part no.
19-piece	82200L





## Spiral drill bit



HSS, ground, 1/4" drive



ⓘ The short length significantly reduces the risk of breakage

Size	Length	Part no.
1,00 mm	32 mm	82200-1,00
1,50 mm	32 mm	82200-1,50
2,00 mm	34 mm	82200L-2,00
2,50 mm	36 mm	82222L
3,00 mm	39 mm	82200-3,00
3,30 mm	38 mm	82223L
3,50 mm	40 mm	82200-3,50
4,00 mm	45 mm	82200-4,00
4,20 mm	45 mm	82224L
4,50 mm	46 mm	82200-4,50
5,00 mm	50 mm	82225L
5,50 mm	50 mm	82200-5,50
6,00 mm	50 mm	82200-6,00
6,50 mm	50 mm	82200-6,50
6,80 mm	50 mm	82226L
7,00 mm	50 mm	82200-7,00
7,50 mm	51 mm	82200-7,50
8,00 mm	51 mm	82200-8,00
8,50 mm	53 mm	82227L
9,00 mm	53 mm	82200-9,00
9,50 mm	54 mm	82200-9,50
10,00 mm	54 mm	82200-10,00

## Spiral drill



for professional drilling work in concrete, stone and masonry in all lathes and percussion drills.

With stable TCT plate, point angle 130°, DIN 8039, milled spiral groove, surface burnished then polished



Size	Length	Part no.
3,00 mm	75 mm	80801SB
4,00 mm	75 mm	80802SB
5,00 mm	85 mm	80803SB
6,00 mm	100 mm	80804SB
7,00 mm	100 mm	80805SB
8,00 mm	120 mm	80806SB
9,00 mm	120 mm	80807SB
10,00 mm	120 mm	80808SB
12,00 mm	120 mm	80810SB
13,00 mm	150 mm	80811SB
14,00 mm	150 mm	80812SB

## Masonry breaching drill set



with SDS shank, 12 - 16 - 24 mm x 1,000 mm long



ⓘ Extra long

Description	Part no.
3-piece	S2012



## Weld spot drill



for pneumatic weld spot drills Vario, HSS-E, TITANIUM nitrified



① For pneumatic machines

Size	Length	Part no.
8 mm	44 mm	82588L

## Weld spot drill



HSS, regrindable



Size	Length	Part no.
6 mm	66 mm	82560L
7 mm	74 mm	82570L
8 mm	79 mm	82580L

## Weld spot drill



HSS-E, TITANIUM nitrified - ca. 5 times the tool life, regrindable



Size	Length	Part no.
8 mm	79 mm	82591L

## Weld spot cutter



with exchangeable cutter, HSS



Description	Part no.
Complete cutter	82500L
Replacement cutter	82501L

## Quick-release chuck



Description	Part no.
0.8 - 10 mm, 3/8", 24 UNF, right-hand rotation	S9935
2 - 13 mm, 1/2", right-hand rotation	S9936

## Chuck



3-piece, with SDS adapter and chuck key  
impact-resistant, right- and left-hand rotation



Description	Part no.
3-piece, 2 - 13 mm (1/2"), right-and left-hand rotation	S9937



## Twist drill set



HSS, TITANIUM nitrified for extremely long tool life.

- 4 - 12 mm (4, 5, 6, 7, 8, 9, 10, 11, 12 mm)
- 4 - 20 mm (4, 6, 8, 10, 12, 14, 16, 18, 20 mm)
- 4 - 30 mm (4, 6, 8, 10, 12, 14, 16, 18, 20, 22, 24, 26, 28, 30 mm)



**Description**

3-piece

**Part no.**

**82415L**



## Twist drill set



HSS nitride coated, right-handed thread, high cutting capacity and feed thanks to spiral groove shape.

- 4, 5, 6, 7, 8, 9, 10, 11, 12 mm
- 4, 6, 8, 10, 12, 14, 16, 18, 20 mm
- 6, 8, 10, 12, 14, 16, 18, 20, 22, 24, 26, 28, 30 mm



**Description**

3-piece

**Part no.**

**82416L**

6-30 mm

**82417L**

(6, 8, 10, 12, 14, 16, 18, 20, 22, 24, 26, 28, 30 mm)



## Twist drill



HSS, titanium nitrified for optimum tool life, industrial quality, drilling steps increasing in steps of 2 mm



**Description**

4 - 22 mm

**Part no.**

**82411SB**

4 - 32 mm

**82412SB**



## Twist drill



HSS nitride coated, right-handed thread, high cutting capacity and feed thanks to spiral groove shape.



**Description**

6-30 mm,

6, 8, 10, 12, 14, 16, 18, 20, 22, 24, 26, 28, 30

**Part no.**

**82417L**



## Step drill

DIN HSS YYY

HSS, right-handed thread with crosswise grinding  
Ideal for metric cable glands in accordance with DIN/EN 50262

- for sheet steel and stainless steel, max. 2 mm thickness
- for non-metals max. 5 mm thickness
- with 11 stages
- 10 mm drive for drill



Description	Part no.
6,5 - 40,5 mm	82418L

## Hole cutter

HSS YYY

HSS in industrial quality



Description	Part no.
8 - 20 mm	82401L
5 - 31 mm	82404L
16 - 30 mm	82402L
24 - 40 mm	82403L

## Assortment of countersinks

DIN HSS YYY

- HSS
- DIN 335 Form C
- packed in metal box

Sizes: 6,3 - 8,3 - 10,4 - 12,4 - 16,5 - 20,5



Description	Part no.
6-piece	82420L
12,4 mm	82421L

## Hardmetal burrs

YYY

Hardmetal burrs as per DIN8033

- for deflashing, chamfer edges, weld seam and surface machining
- staggered teeth joint for great removal of material on cast iron, steel and stainless steel
- shaft diameter 6 mm

Contents:

- 1x form B – cylindrical with end-face serration toothing
- 1x form D – ball shape
- 1x form G – pointed arch shape



Description	Part no.
3-piece	82550L





## Threading die adapter set



can be used for all threading dies from M3 – M14, allows straightforward cutting of outer threads, with a ratchet wrench it can even be used in spots that are difficult to access, such as stud bolts etc.

- die holder for 20 x 5 mm
- die holder for 25 x 9 mm
- die holder for 30 x 11 mm
- die holder for 38 x 14 mm
- die holder extension 63 mm
- die holder extension 98 mm
- hexagon adapter



Description	Part no.
7-piece	<b>82280L</b>
For DIN threading dies 20 x 5 mm	<b>82280L-1</b>
For DIN threading dies 25 x 9 mm	<b>82280L-2</b>
For DIN threading dies 30 x 11 mm	<b>82280L-3</b>
For DIN threading dies 38 x 14 mm	<b>82280L-4</b>
Extension 63 mm	<b>82280L-5</b>
Extension 98 mm	<b>82280L-6</b>
Hexagon adapter	<b>82280L-7</b>

## Thread tap set



in metal box, HSS, ground taper, second and finishing tap

Each 3 x M3 - 4 - 5 - 6 - 8 - 10 - 12



Description	Part no.
21-piece, M3 - M12	<b>81790L</b>

## Thread cutting tool set



HSS, ground, in powder-coated metal box

- Hand tap sets
- M3 - 4 - 5 - 6 - 8 - 10 - 12
- Tap wrenches
- Thread gauges
- Tool holders with ratchet
- 7 HSS core movers



Description	Part no.
31-piece, M3 - M12	<b>82231L</b>

## Thread cutting tool set



HSS, ground, in powder-coated metal box

- hand tap sets and round threading dies
- M3 - 4 - 5 - 6 - 8 - 10 - 12
- tap wrenches
- die holder
- thread gauge



Description	Part no.
32-piece, M3 - M12	<b>82233L</b>

## Thread cutting tool set

HSS, ground, in plastic box

- hand tap sets and round threading dies
- M3 - 4 - 5 - 6 - 8 - 10 - 12
- tap wrenches
- thread gauges
- tool holders with ratchet
- 7 HSS core drills



DIN HSS YYY



Description  
40-piece, M3 - M12

Part no.  
82245L

## Thread cutting tool set

M2 - M18

- Normal threads
- Fine threads
- Tool holder
- Die holder
- Adapter
- Thread taps and threading dies in the following sizes:
- M2 x 0.4, M3 x 0.5, M4 x 0.7, M5 x 0.8, M6 x 1.0, M6 x 0.75, M7 x 1.0, M7 x 0.75, M8 x 0.75, M8 x 1.0, M8 x 1.25, M9 x 0.75, M9 x 1.0, M9 x 1.25, M10 x 0.75, M10 x 1.0, M10 x 1.25, M10 x 1.5, M11 x 0.75, M11 x 1.0, M11 x 1.25, M11 x 1.5, M12 x 0.75, M12 x 1.0, M12 x 1.25, M12 x 1.5, M12 x 1.75, M14 x 1.0, M14 x 1.25, M14 x 1.5, M14 x 2.0, M16 x 1.0, M16 x 1.5, M16 x 2.0, M18 x 1.5

① Only suitable for cleaning or re-cutting existing threads.



YYY

Description  
110-piece, M2 - M18

Part no.  
82251L

## Thread cutting tool set

Packed in a plastic box. Contains threading die and tap in the following sizes:

- |                      |                        |
|----------------------|------------------------|
| <b>Fine threads:</b> | <b>Normal threads:</b> |
| • 6x0.75             | • 6x1.0                |
| • 8x1.0              | • 8x1.25               |
| • 10x1.25            | • 10x1.5               |
| • 12x1.5             | • 12x1.75              |
| • 14x1.5             | • 14x2.0               |
| • 16x1.5             | • 16x2.0               |
| • 18x1.5             | • 18x2.5               |
| • 20x1.5             | • 20x2.5               |
| • 22x1.5             | • 22x2.5               |
| • 24x1.5             | • 24x3.0               |

- Also included:
- screwdriver, slotted
  - adapter
  - die holder
  - tap wrench
  - tool holder



YYY

① Only suitable for cleaning or re-cutting existing threads.

Description  
45-piece, M6 - M24  
45-piece, Tungsten steel, 1/4 " - 1"  
Empty case for 82250L / 82250L-ZOLL / 82255L

Part no.  
82250L  
82250L-ZOLL  
82250L-KOFFER



## Thread cutting tool set

- normal threads
- fine threads
- tool holders
- die holders
- adapters
- etc.



① Only suitable for cleaning or re-cutting existing threads.

Description	Part no.
45-piece, Titanium nitrified, M6 - M24	82255L



## Range of thread and tap drills, M4 – M10

very handy combination range for drilling, cutting and counterboring the most common standard metric threads.

Contents:

- tap twist drill HSS-G DIN338:  $\varnothing$  3.3 mm,  $\varnothing$  4.2 mm,  $\varnothing$  5.0 mm,  $\varnothing$  6.8 mm,  $\varnothing$  8.5 mm
- thread tap form B DIN371 HSS-E (Co5): M4x0.7, M5x0.8, M6x1.0, M8x1.25, M10x1.5
- countersink 90° HSS DIN335C HSS,  $\varnothing$  10.4 mm,  $\varnothing$  16.5 mm



handy plastic box with threaded cover.

Description	Part no.
12-piece, M4 - M10	82229L



## Thread gauge

for thread cutting tool set, metrical



Description	Part no.
	82246L



## Tap extension

according to DIN 377, squares according to DIN 10



Description	Size	Length	Part no.
M3	2,7 mm	80 mm	81622L
M4	3,4 mm	95 mm	81623L
M5 - M6 - M8	4,9 mm	110 mm	81624L
M9 - M10	5,5 mm	115 mm	81625L
M 11	6,2 mm	120 mm	81626L
M12 - M13	7,0 mm	125 mm	81627L
M14 - M16	9,0 mm	130 mm	81629L



## Tap wrench

adjustable, according to DIN 1814



Description	Part no.
M1 - M8, Size 0	81801L
M1 - M10, Size 1	81802L
M1 - M12, Size 1,5	81803L
M4 - M20, Size 2	81804L
M5 - M20, Size 3	81805L
M9 - M27, Size 4	81806L



## Tool holder

with ratchet, switchable



Description	Length	Part no.
M3 - M8	60 mm	81601L
M5 - M12	130 mm	81602L
M3 - M8	255 mm	81603L
M5 - M12	310 mm	81604L

## Hand tap set

DIN 352, HSS, ground taper, second and finishing tap



Description	Thread	Thread pitch	Part no.
3-piece	M3	0,5	81700L
Taper tap	M3	0,5	81711L
Second tap	M3	0,5	81712L
Finishing tap	M3	0,5	81713L
3-piece	M4	0,7	81701L
Taper tap	M4	0,7	81714L
Second tap	M4	0,7	81715L
Finishing tap	M4	0,7	81716L
3-piece	M5	0,8	81702L
Taper tap	M5	0,8	81717L
Second tap	M5	0,8	81718L
Finishing tap	M5	0,8	81719L
3-piece	M6	1,00	81703L
Taper tap	M6	1,00	81720L
Second tap	M6	1,00	81721L
Finishing tap	M6	1,00	81722L
3-piece	M7	1,00	81785L
3-piece	M8	1,25	81704L
Taper tap	M8	1,25	81723L
Second tap	M8	1,25	81724L
Finishing tap	M8	1,25	81725L
3-piece	M10	1,50	81705L
Taper tap	M10	1,50	81726L
Second tap	M10	1,50	81727L
Finishing tap	M10	1,50	81728L
3-piece	M12	1,75	81706L
Taper tap	M12	1,75	81729L
Second tap	M12	1,75	81730L
Finishing tap	M12	1,75	81731L
3-piece	M14	2,00	81707L
Taper tap	M14	2,00	81732L
Second tap	M14	2,00	81733L
Finishing tap	M14	2,00	81734L
3-piece	M16	2,00	81708L
Taper tap	M16	2,00	81735L
Second tap	M16	2,00	81736L
Finishing tap	M16	2,00	81737L
3-piece	M18	2,50	81709L
Taper tap	M18	2,50	81738L
Second tap	M18	2,50	81739L
Finishing tap	M18	2,50	81740L
3-piece	M20	2,50	81710L
Taper tap	M20	2,50	81741L
Second tap	M20	2,50	81742L
Finishing tap	M20	2,50	81743L





## Single tooth thread tap

DIN HSS YYY

DIN 352, HSS, ground



① Taper, second and finishing tap in one

Thread	Thread pitch	Part no.
M3	0,50	81750L
M4	0,70	81751L
M5	0,80	81752L
M6	1,00	81753L
M8	1,25	81754L
M10	1,50	81755L
M12	1,75	81756L

## Single tooth thread tap

HSS YYY

for thread inserts

Taper, second and finishing tap in one



Thread	Thread pitch	Part no.
M5	0,8	84031L
M6	1,0	84032L
M7	1,0	84033L
M8	1,25	84034L
M10	1,50	84035L
M12	1,75	84036L
M14	1,25	84037L

## Hand tap set

DIN HSS YYY

DIN 2181, HSS, ground



① Fine-thread taper and finishing tap

Description	Thread	Thread pitch	Part no.
2-piece	M3	0,35	81760L
2-piece	M4	0,35	81761L
2-piece	M4	0,50	81762L
2-piece	M5	0,50	81763L
2-piece	M6	0,75	81764L
2-piece	M8	0,75	81765L
2-piece	M8	1,00	81766L
2-piece	M10	1,00	81767L
2-piece	M10	1,25	81768L
2-piece	M11	1,25	81780L
2-piece	M12	1,00	81769L
2-piece	M12	1,25	81770L
2-piece	M12	1,50	81771L
2-piece	M14	1,25	81772L
2-piece	M14	1,50	81773L
2-piece	M16	1,50	81774L
2-piece	M18	1,50	81775L
2-piece	M20	1,50	81776L
2-piece	M24	1,50	81778L

## Die holder

DIN 

according to DIN 225



Description	Part no.
for M1 - M3, 16 x 5 mm	82000L
for M3 - M4, 20 x 5 mm	82001L
for M4 - M6, 20 x 7 mm	82002L
for M7 - M9, 25 x 9 mm	82003L
for M10 - M11, 30 x 11 mm	82004L
for M12 - M14, 38 x 14 mm	82005L
for M16 - M20, 45 x 18 mm	82006L
for M22 - M24, 55 x 22 mm	82007L
for M27 - M36, 65 x 25 mm	82008L

## Round threading die

HSS 

HSS

standard outer diameter



Thread	Thread pitch	Width	Height	Part no.
M3	0,50	25 mm	9 mm	81930L
M4	0,70	25 mm	9 mm	81931L
M5	0,80	25 mm	9 mm	81932L
M6	1,00	25 mm	9 mm	81933L
M8	1,25	25 mm	9 mm	81934L
M10	1,50	25 mm	9 mm	81935L
M12	1,75	25 mm	9 mm	81936L

## Round threading die

DIN  HSS 

according to DIN 223, HSS

different DIN outer diameters



Thread	Thread pitch	Width	Height	Part no.
M3	0,50	20 mm	5 mm	81900L
M4	0,70	20 mm	5 mm	81901L
M5	0,80	20 mm	7 mm	81902L
M6	1,00	20 mm	7 mm	81903L
M7	1,00	25 mm	9 mm	81940L
M8	1,25	25 mm	9 mm	81904L
M10	1,50	30 mm	11 mm	81905L
M12	1,75	38 mm	14 mm	81906L
M14	2,00	38 mm	14 mm	81907L
M16	2,00	45 mm	18 mm	81908L
M18	2,50	45 mm	18 mm	81909L
M20	2,50	45 mm	18 mm	81910L



## Round threading die

DIN HSS YYY

according to DIN 223, HSS  
different DIN outer diameters



### ① Fine thread pitch

Thread	Thread pitch	Width	Height	Part no.
M3	0,35	20 mm	5 mm	81911L
M4	0,35	20 mm	5 mm	81912L
M4	0,50	20 mm	5 mm	81913L
M5	0,50	20 mm	5 mm	81914L
M6	0,75	20 mm	7 mm	81915L
M8	0,75	25 mm	9 mm	81916L
M8	1,00	25 mm	9 mm	81917L
M10	1,00	30 mm	11 mm	81918L
M10	1,25	30 mm	11 mm	81919L
M12	1,00	38 mm	10 mm	81920L
M12	1,25	38 mm	10 mm	81921L
M12	1,50	38 mm	10 mm	81922L
M12	1,75	38 mm	14 mm	81906L
M14	1,25	38 mm	10 mm	81923L
M14	1,50	38 mm	10 mm	81924L
M16	1,50	45 mm	14 mm	81925L
M18	1,50	45 mm	14 mm	81926L
M20	1,50	45 mm	14 mm	81927L

## Tap bit set

HSS 6.3 1/4 YYY

Single tooth tap, HSS, ground, in patented folding box, 6.3 mm (1/4") drive

- M 3 - 4 - 5 - 6 - 8 - 10



Description  
6-piece

Part no.  
82220L

## Tap bit

HSS 6.3 1/4 YYY

HSS, ground, 6.3 mm (1/4") drive

### ① The short length is ideal for spots that are difficult to reach



Thread	Thread pitch	Length	Part no.
M3	0,50	33 mm	82211L
M4	0,70	35 mm	82212L
M5	0,80	36 mm	82213L
M6	1,00	39 mm	82214L
M8	1,25	40 mm	82215L
M10	1,50	41 mm	82216L

## Tap and spiral drill bit set

HSS 6.3 1/4 YYY

Single tooth tap and spiral drill bits, HSS, ground, in patented folding box, 1/4" drive

- Thread taps: M 3 - 4 - 5 - 6 - 8 - 10
- Spiral drill: 2,5 - 3,3 - 4,2 - 5,0 - 6,8 - 8,5 mm



Description  
12-piece

Part no.  
82230L

## Combined drill bit set

HSS, ground, 6.3 mm (1/4") drive,"3 in 1"

- M3 - 4 - 5 - 6 - 8 - 10



① Core moving, thread tapping & deburring

Description	Part no.
6-piece	82700L

## Combined drill bit

6.3 mm (1/4") drive,"3 in 1"



① Core moving, thread tapping & deburring

Thread	Thread pitch	Part no.
M3	0,50	82701L
M4	0,70	82702L
M5	0,80	82703L
M6	1,00	82704L
M8	1,25	82705L

# Thread Repair Tools

## Stud bolt thread repair kit

for re-cutting or cleaning stud bolts or screws. The cutting jaws can be separated to place the tool on an undamaged thread section. The thread can then be cleaned or re-cut. Especially suitable for wheel bolts or wheel screws.

For outer thread: M12x1.25, M12x1.50, M14x1.50



Produktqualität	Length	Width	Height	Weight	Part no.
	125 mm	88 mm	46 mm	0,26 kg	02371L

## Thread repair set

in box, complete with the respectively suitable spiral drill (Ø 5,2 mm, 6,3 mm, 8,3 mm, 10,4 mm, 12,4 mm), tap, inserting tool, tang break tool and repair inserts.

Includes the following sizes:

- M5 x 0,8
- M6 x 1,00
- M8 x 1,25
- M10 x 1,50
- M12 x 1,75



Part no.  
84015L



## Thread repair set

in box, complete with the respectively suitable spiral drill (Ø 6,3 mm, 8,3 mm, 10,4 mm, 12,4 mm, 14,4 mm), tap, inserting tool, tang break tool and repair inserts.

Includes the following sizes:

- M6 x 1,00
- M8 x 1,25
- M10 x 1,50
- M12 x 1,75
- M14 x 1,25



Part no.  
**84016L**

## Thread repair set

complete with spiral drill, tap, inserting tool, tang break tool and repair inserts



Thread	Thread pitch	Part no.
M5	0,8	<b>84017L</b>

Part no.  
**84017L**

## Thread repair set

complete with spiral drill, tap, inserting tool, tang break tool and repair inserts



Thread	Thread pitch	Part no.
M6	1,0	<b>84018L</b>

Part no.  
**84018L**

## Thread repair set

complete with spiral drill, tap, inserting tool, tang break tool and repair inserts



Thread	Thread pitch	Part no.
M7	1,0	<b>84019L</b>

Part no.  
**84019L**

## Thread repair set

complete with spiral drill, tap, inserting tool, tang break tool and repair inserts



Thread	Thread pitch	Part no.
M8	1,25	<b>84020L</b>

Part no.  
**84020L**

## Thread repair set

complete with spiral drill, tap, inserting tool, tang break tool and repair inserts



Thread	Thread pitch	Part no.
M10	1,50	84021L

## Thread repair set

complete with spiral drill, tap, inserting tool, tang break tool and repair inserts



Thread	Thread pitch	Part no.
M12	1,75	84022L

## Thread repair set

for spark plug threads, with tap, inserting tool and repair inserts



① In the case of spark plug threads, the tang must be removed by long-nosed pliers

Thread	Thread pitch	Part no.
M14	1,25	84023L

## Repair sleeves

25-piece



Thread	Thread pitch	Part no.
M5	0,8	84024L
M6	1,0	84025L
M7	1,0	84030L
M8	1,25	84026L
M10	1,50	84027L
M12	1,75	84028L
M14	1,25	84029L

## Installation hook and Tang break tool

for thread inserts  
2-piece



Thread	Thread pitch	Part no.
M5	0,8	84038L
M6	1,0	84039L
M7	1,0	84040L
M8	1,25	84041L
M10	1,50	84042L
M12	1,75	84043L
M14	1,25	84044L





## Thread file



for inner and outer threads, makes fast cleaning of threads from rust or soiling possible



Description	Length	Part no.
Metric pitches 0.80 - 1.00 - 1.25, 1.50 - 1.75 - 2.00 - 2.50 - 3.00	230 mm	<b>81680L</b>
Imperial pitches 10 - 11 - 12 - 14 - 16 - 18 - 20 - 24 turns per inch	230 mm	<b>81685L</b>

## Thread tapping set



for cleaning and recutting wheel screws and threads. Complete with 10 mm (3/8") seats for mounting by ratchet.

- M12 x 1,25 mm
- M12 x 1,50 mm
- M14 x 1,50 mm



ⓘ **Rusty and faulty threads cause false torque values and can lead to loose wheels!**

Description	Part no.
12-piece	<b>02370L</b>

## Thread cutting tool set



9 part set in a plastic case, for the servicing and repairing the thread on/in the connecting piece for the gas/fluid lines of refrigeration, gas and hydraulic equipment.

The thread size of the individually contained chaser is marked separately. Through this it can be used for measuring and determining thread sizes.

- for trimming and cleaning outer and inner threads
- the drive takes place via a jointly supplied axle or socket wrench insert

sizes that are contained:

- M14 x 1.5 - M16 x 1.5 - M18 x 1.5 - M 20 x 1.5 - M22 x 1.5 - M24 x 1.5 - M27 x 2.0 - M28 x 1.5



Description	Part no.
9-piece, M14 - M28	<b>82240L</b>



## Stud bolt extractor set

Only system in the world not to apply radial pressure to the sheared off bolt. Can be used for thread sizes M5 + M6 + M8 + M10

- for raised torn off bolts
- for flush torn off bolts
- for sunken torn off bolts

Ideal for manifold screws e.g. Opel and VAG



Audi  
Opel  
Seat  
Škoda  
VW



Description	Size	Length	Part no.
22-piece			<b>04150L</b>
Drill bushing 5.1 mm with thread			<b>04150GB5,1</b>
Drill bushing 2,6 mm			<b>04150BB2,6</b>
Drill bushing 3,4 mm			<b>04150BB3,4</b>
Drill bushing 5,1 mm			<b>04150BB5,1</b>
Hand tap M3 left, 1st turn			<b>04150HGB3-1</b>
Hand tap M3 left, 3rd turn			<b>04150HGB3-3</b>
Hand tap M4 left, 1st turn			<b>04150HGB4-1</b>
Hand tap M4 left, 3rd turn			<b>04150HGB4-3</b>
Hand tap M6 left, 1st turn			<b>04150HGB6-1</b>
Hand tap M6 left, 3rd turn			<b>04150HGB6-3</b>
Byloos screw type 1, for M5 thread			<b>04150L-1</b>
Byloos screw type 2, for M6 thread			<b>04150L-2</b>
Byloos screw type 3, for M8 + M10 threads			<b>04150L-3</b>
Spiral drill	2,50 mm	58 mm	<b>KOB-2,50</b>
Spiral drill	3,30 mm	66 mm	<b>KOB-3,30</b>
Spiral drill	5,00 mm	86 mm	<b>KOB-5,00</b>
Short strip (flange) 25 x 15 x 93 mm			<b>04165KL</b>
Long strip (flange) 25 x 15 x 140 mm			<b>04165LL</b>
Guide bush for M6 flanges			<b>04165FH6</b>
Guide bush for M8 flanges			<b>04165FH8</b>

## Stud bolt extractor set

comprising a double-ring ratchet spanner 14 x 17 mm and four special inserts for the automatic clamping of the stud bolts in sizes 6, 8, 10 and 12 mm



Description	Part no.
5-piece	<b>04169L</b>

## Reaming tool set

for heavily damaged bolts and nuts along with torn stud bolts

- 4 inserts, 12.5 mm (1/2") / hex-socket drive wrench size 21 with automatic stud bolt clamping in sizes 6, 8, 10 and 12 mm, chrome-vanadium
- 8 special inserts for worn-out bolts and nuts made of high-alloy chrome-molybdenum steel, 9 - 10 - 11 - 12 - 13 - 14 - 16 - 19 mm / 10 mm (3/8") drive
- 5 screw extractors with square drive for M 3-6 / M 6-8 / M8-11 / M11-14 / M14-18 (drill into bolts beforehand)



Description	Part no.
17-piece	<b>04166L</b>

## Stud bolt extractors

- 6 - 8 - 10 - 12 mm



Part no.
<b>04160L</b>



## Stud bolt extractor

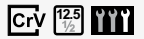

for quick replacing of stud bolts



Size	Part no.
6 mm	04161L
8 mm	04162L
10 mm	04163L
12 mm	04164L

## Stud extractor



to extract broken studs with a diameter of 6.3 mm to 14 mm

- Right/left clamp function
- with 19 mm hex drive



Part no.  
04167L

## Helical groove inserts, Spiral groove



to release badly damaged nuts and bolts. The high-alloy special steel, combined with the aggressive groove profile, loosens all bolts. 10 mm (3/8") drive and additional external hex



Description	Part no.
11-piece, 8-10-11-12-13-14-15-16-17-19 mm	05555L

## Helical groove insert, Spiral groove



to release badly damaged nuts and bolts. The high-alloy special steel, combined with the aggressive groove profile, loosens all bolts. 10 mm (3/8") drive and additional external hex



Size	Part no.
8 mm	05555L-8
10 mm	05555L-10
11 mm	05555L-11
12 mm	05555L-12
13 mm	05555L-13
14 mm	05555L-14
15 mm	05555L-15
16 mm	05555L-16
17 mm	05555L-17
19 mm	05555L-19

## Spiral groove sockets, Spiral groove

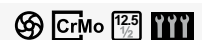

12.5 mm (1/2") drive, for loosening heavily damaged nuts and bolts. The high-alloy special steel combined with the aggressive groove profile makes it possible to loosen all screws.



Description	Part no.
10-piece, 10 - 11 - 12 - 13 - 14 - 15 - 16 - 17 - 19 mm	05545L

## Helical groove insert, Spiral groove



to release badly damaged nuts and bolts. The high-alloy special steel, combined with the aggressive groove profile, loosens all bolts.



Size	Length	Part no.
10 mm	24 mm	05545L-10
11 mm	24 mm	05545L-11
12 mm	24 mm	05545L-12
13 mm	24 mm	05545L-13
14 mm	24 mm	05545L-14
15 mm	24 mm	05545L-15
16 mm	24 mm	05545L-16
17 mm	24 mm	05545L-17
19 mm	24 mm	05545L-19

## Spiral slot inserts, Spiral groove

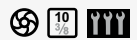

(For example hexagon socket / XZN tripe square / T-profile) or damaged studs (pre-drill!) For turning out round-turned inner profile screws. The left-turning, tapered spiral profile ensures an optimal force connection between tool and defective screw / stud bolts due to its aggressive surface structure and reliably remove the bolt.



- 3/8" inner square / 17 mm outer hexagon: 2, 3, 4, 5, 6 mm
- 1/2" inner square / 22 mm outer hexagon: 8, 10, 12, 14 mm

Description	Part no.
9-piece, 2 - 14 mm or M5 - M24	05542L
Spiral groove socket with 2 mm diameter out of 05542L	05542L-2
Spiral groove socket with 3 mm diameter out of 05542L	05542L-3
Spiral groove socket with 4 mm diameter out of 05542L	05542L-4

## Screw extractor set



in box

- M3 - M19



Description	Part no.
5-piece	82105L

## Nut splitter



for the mechanical splitting of faulty or overwound nuts without damaging the thread



Description	Part no.
7 up to 16 mm	11000SB
13 up to 24 mm	11005L





## Hook Set

This special hook set includes four spoon-like hooks for levering O-rings out of a groove. These hooks do not have any sharp edges to prevent damage to the O-ring or the seat of the seal. Slip-proof handles ensure a firm and strong purchase. The SW-Stahl cloth bag allows neat storage of the hooks.

The set contains:

- four spoon-like hooks
- hook with straight tip
- hook with angled tip (90°)
- hook with curved tip
- hook as piercing awl



Description

8-piece

Part no.

94872L

## Scraper and hook set

hardened

- scraper 275 mm
- scraper 215 mm
- hook 90°
- parting awl
- hook 45°



Description

5-piece

Part no.

94880L

## Mini hook set

Ideal for O-rings, seals etc.

- straight tip
- 90° tip
- hook tip
- parting awl



Description

4-piece

Part no.

94870L

## Mini hook set

ideal for O-rings, seals etc.  
With non-slip handles

- straight tip
- 90° tip
- hook tip
- parting awl



Description

4-piece

Part no.

94871L

## Universal hook set

deal for removing shaft sealing rings and O-rings. The special corkscrew shape of the tips allows sealing and O-rings to be removed even where space is tight e.g. on the camshaft, gearshift lever shaft etc.

- 170 mm and 120 mm T-handle with cell rubber in corkscrew shape
- 150 mm mini-hook, angled twice, 75 mm blade length



Description	Part no.
3-piece	94874L

## Fitting hook

Perfect for the removal and fitting of springs on brakes, headlights, motorbike mufflers and much more besides. The bent shape of the spring hook allows a free view of the fitting spot

- alloyed steel
- hardened



Length	Part no.
160 mm	10515L

## Special scraper set

with sharp edges in different widths, e.g. for glass adhesive

- 5 blades each 12, 16, 20 mm + 16 mm/53°
- 5 trapezoidal blades
- Universal blade
- 2-component scraper handle



Description	Part no.
27-piece	94860L
10 blades 12 mm	94861L
10 blades 16 mm	94862L
10 blades 20 mm	94863L
10 blades 16 mm / 53°	94864L
10 trapezoidal blades	90657L

## Seal scraper set

stainless, handle lengths each 115 mm

- 100 x 31 mm, thickness 1.1 mm
- 100 x 31 mm, thickness 2.4 mm
- 50 x 20 mm, thickness 1.1 mm
- 50 x 20 mm, thickness 2.4 mm



Description	Part no.
4-piece	94840L

## Quality scraper

forged, with wooden handle

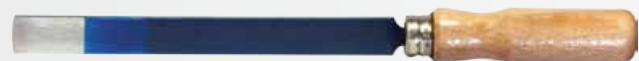

Description	Length	Part no.
Flat scraper	325 mm	94100L
Triangular hollow scraper	325 mm	94200L
Triangular spoon scraper	325 mm	94300L



## Triangular hollow scraper



with hardwood handle



Part no.  
**94201L**

## Quality scraper set



with plastic handle,  
Blade width 23 mm, length 240 mm



Description	Part no.
2-piece	<b>94820L</b>
Sticker scraper	<b>94810SB</b>
Seal scraper	<b>94815SB</b>

## Quality scraper



with plastic handle,  
Blade width 23 mm, length 240 mm



Description	Part no.
Seal scraper	<b>94815L</b>

## Professional scraper



stainless, with extra sharp blade, ideal for window adhesive



Description	Part no.
Blade width: 30 mm	<b>94825SB</b>

## Scraper set



with 40 mm wide, exchangeable blades

- used for all applications
- due to its extra small design, can also be used in hard to reach places



Description	Part no.
2-piece	<b>90603SB</b>

## Painter's spatula



with wooden handle



Length	Width	Part no.
220 mm	100 mm	<b>91006L</b>

## Brush set

comprising a handle with extension and 36 assorted brushes with 1/4" drive and 8-9-10-11-12-13-14-15-16-17-18-19 mm diameter for cleaning and deburring cylinders, bushings, pipes and other workpieces with nylon facing, brass facing and steel facing

Application examples are:

- brake callipers sleeve
- O-ring cut-ins
- injector seat
- valves on exhaust gas recirculation
- inlets and outlets
- crossbar seal on injection lines on Opel cylinder heads



VW  
Opel  
Mercedes-Benz



ⓘ when used with machine only use clockwise running

Description

Part no.

38-piece

62330L

## Brush head

in painting brush design, with 6 mm clamping mandrel, for use with drills, steel wire, max 4,500 rpm.



Dia.

Part no.

30 mm

62220L

## Brush head

with 6 mm clamping mandrel, for use with drills, steel wire, max 4,500 rpm.



Dia.

Part no.

50 mm

62203SB

75 mm

62204SB

## Brush head

with thread connection M14, for use with one-hand angle grinders, max 12,000 rpm.



Dia.

Part no.

65 mm

62210SB

80 mm

62211L

## Disc brush

with 6 mm clamping mandrel for use with drills, steel wire, max 4,500 rpm.



Dia.

Part no.

75 mm

62303SB

100 mm

62304SB





## Disc brush



braided, with 6 mm clamping mandrel for use with drills, steel wire, max 12,500 r.p.m.

Especially long-life industrial brush



Dia.

Part no.

75 mm

62320SB

## Disc brush



braided, in cone form, with M14 x 2 mm thread connection for use in one-hand angle grinders, steel wire, max 12,500 rpm.

Especially long-life industrial brush



① Cone form

Dia.

Part no.

100 mm

62315SB

115 mm

62316SB

## Disc brush



braided, with 22.2 mm bore hole for use in one-hand angle grinders, steel wire, max 11,000 rpm.

Especially long-life industrial brush



Dia.

Part no.

115 mm

62310SB

## Brush set

comprising one brush each made of brass, steel and plastic



Description

Part no.

3-piece

93910L

## Spark plug brush



made of brass wire, for gentle cleaning of the spark plug electrode.



Length

Part no.

150 mm

93900L

## Hand brush



made of steel wire, with wooden body



① Steel wire

Description

Part no.

2-rowed

61301L

3-rowed

61302L

4-rowed

61303L

5-rowed

61304L



## Hand brush

made of brass, with wooden body

① Brass



Description	Part no.
2-rowed	61201L
3-rowed	61202L
4-rowed	61203L
5-rowed	61204L

## Assortment of brushes

made of pure China bristles



Description	Part no.
5-piece	61405SB

## Assortment of brushes

repair brushes, different sizes



Description	Part no.
9-piece	61409SB

## Workshop files

for metal, with wooden handle

Round, flat, half-round, triangular, square



Description	Length	Part no.
5-piece	300 mm	90902SB

## Industry-standard file

with plastic handle



Description	Part no.
Flat hand, cut 2, 200 mm	90931L
Half round, cut 2, 200 mm	90932L
Round, cut 2, 200 mm	90933L
Three-square, cut 2, 200 mm	90934L
Square, cut 2, 200 mm	90935L

## Key file set

with plastic handle, different profiles.



Description	Part no.
6-piece	93706SB



## Contact file



e.g. for cleaning spark-plug contacts



Length

Part no.

150 mm

93605L

## Grinding tool set



with 6 mm shaft for use with drills



Description

Part no.

5-piece

62500SB

## Grinding tool set



ceramic, with a 6 mm receiver shaft for use with drills and axial grinders. The set contains the shaped grinding points which are used most often incl. roughening files. Suitable for use with all steel grades: For burring, beveling and breaking edges.

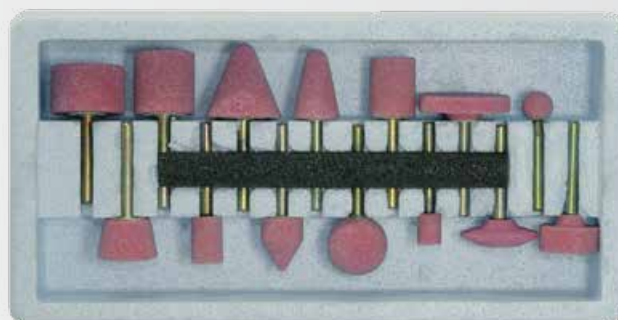

- 2 pens (cone shape/semi-round) 32x32 + 32x29
- 1 pen (cone shape/pointed) 18x22
- 2 pens (ball shape) 25 mm + 13 mm
- 1 pen (bowl) 25x16
- 1 pen (flat/round) 32 x 6
- 7 pins (cylindric) 10x13, 13x20, 20x25, 25x10, 25x25, 32x20, 40x6
- 1 roughening file (semi-round) 16x150 mm

Description

Part no.

15-piece

62510L

# Hammers / Chisels / Punches

## Locksmith's hammer set

forged, with fibreglass handle, absolutely "wobble-free" attachment, handle area with rubber insulation

Head weights: 300 - 500 - 800 g



① Fibreglass handle

Description

Part no.

3-piece

50430L

## Locksmith's hammer

- forged
- with fibreglass handle
- absolutely "wobble-free" attachment
- handle area with rubber insulation



① Fibreglass handle

Head weight

Part no.

300 g

50403L

500 g

50405L

800 g

50408L

1000 g

50410L

2000 g

50420L

## Hammer assortment

high-quality hammer assortment for maximum working safety

- extremely impact-proof
- safety pin
- round safety wedge
- forged head
- manufactured according to DIN 1041

consisting of hammers 50903L, 300 g + 50905L, 500 g + 50908L, 800 g



① Hickory handle and metal shaft protection sleeve

Description	Part no.
3-piece	50930L

## Hammer

high-quality hammer for maximum working safety

- hickory handle, extremely impact-proof
- handle protective sleeve
- safety pin
- round safety wedge
- forged head
- manufactured according to DIN 1041, TÜV-tested



① Hickory handle and metal shaft protection sleeve

Head weight	Part no.
200 g	50902L
300 g	50903L
400 g	50904L
500 g	50905L
800 g	50908L
1000 g	50910L
1500 g	50915L
2000 g	50920L

## Locksmith's hammer

with double-cambered wooden handle and cast ring wedge



Head weight	Part no.
100 g	50101L
200 g	50102L
300 g	50103L
400 g	50104L
500 g	50105L
800 g	50106L
1000 g	50107L
1500 g	50108L
2000 g	50109L





## Hammer handle

suitable for hammers with given head weight



Head weight	Part no.
100 g	50110L
200 g	50111L
300 g	50112L
400 g	50113L
500 g	50114L
800 g	50115L
1000 g	50116L
1500 g	50117L
2000 g	50118L

## Club hammer

forged, with wooden handle



**DIN**

Head weight	Part no.
1000 g	50201L
1250 g	50202L
1500 g	50203L
2000 g	50204L

## Hammer wedges set

- safe hammer wedges made of malleable cast iron
- ground reciprocally, toothed
- suitable for hammers with given head weight of 100-6000 g
- Includes the following sizes:  
2 x 00: 13 mm / 5 x 0: 16 mm / 6 x 1: 20 mm / 5 x 2: 23 mm /  
5 x 3: 26 mm / 2 x 4: 29 mm / 1 x 5: 32 mm



Description	Part no.
25-piece	50128L

## Hammer wedge

suitable for hammers with given head weight.



Description	Head weight	Part no.
Size 00	100 - 200 g	50119L
Size 0	300 - 400 g	50120L
Size 1	500 - 600 g	50121L
Size 2	800 - 1000 g	50122L
Size 3	1500 g	50123L
Size 4	2000 g	50124L
Size 5	3000 - 6000 g	50125L
Size 5,5	8000 g	50126L
Size 6	10.000 g	50127L

## Sledgehammer

with fibreglass handle, the hammer head is wedged and cast, coated matt black, length ca. 900 mm, non-slip rubber handle



Head weight	Part no.
5000 g	50610L

## Sledgehammer

forged, with wooden handle



Head weight	Part no.
3000 g	50600L
4000 g	50601L
5000 g	50602L
6000 g	50603L
8000 g	50604L
10 000 g	50605L

## Rubber hammer

with fibreglass shaft



Head diameter	Head weight	Part no.
60 mm	500 g	50705L
70 mm	750 g	50707L
76 mm	1200 g	50712L

## Rubber hammer

with cambered wooden handle

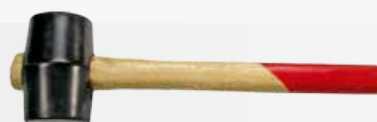

Head diameter	Head weight	Part no.
55 mm	250 g	50701L
65 mm	500 g	50702L
75 mm	750 g	50703L

## Plastic hammer

with wooden handle



Description	Part no.
Complete hammer	51102L
Pair of replacement heads	51105L

## Copper hammer

non-recoil hammer with fibreglass handle for the damage-free striking of bearings, rings etc.



Head diameter	Head weight	Part no.
25 mm	454 g	50501L
32,5 mm	680 g	50502L
38 mm	908 g	50503L

## Panel beating hammer

with fibreglass handle and specially shaped hammer head



Head weight	Length	Part no.
225 g	255 mm	51120L





## Non-recoil hammer



without recoil, completely rubberised

- made of polyurethane glass fibre
- the hammer does not recoil thanks to steel balls in the hammer head
- especially for use during tyre changing for loosening rims that have become rusted tight



Head diameter	Length	Weight	Part no.
60 mm	375 mm	1,2 kg	51112L

## Non-recoil hammer



non-recoil, completely rubberised

- made of polyurethane glass fibre
- the steel balls in the hammer head prevent the hammer recoiling
- especially for use during tyre changing, for loosening rims that have become rusted tight



Head diameter	Length	Weight	Part no.
70 mm	500 mm	2,1 kg	51113L
105 mm	1050 mm	5,250 kg	51115L

## Nail puller



Description	Length	Part no.
German version	500 mm	50607L
Import version	600 mm	50606L

## Chisel



Chrome-vanadium, with tempered punch head, coated



Description	Length	Part no.
Flat chisel	150 mm	94502L
Flat chisel	200 mm	94503L
Flat chisel	250 mm	94504L

## Chisel



Chrome-vanadium, with tempered punch head, coated



Description	Length	Part no.
Cross-cut chisel	175 mm	94510L

## Chisel- and pin punch set



reinforced version with octagon shaft, drop-forged high-strength carbon steel.

- 6 different flat chisel:
  - 12 x 165, 15.5 x 175, 19.5 x 200, 22 x 205, 22 x 255, 25.5 x 250 mm
- 3 pin punch 3 x 150, 5.5 x 255, 9.5 x 255 mm
- 1 drift punch 9.5 x 205 mm
- 2 center punch 150 + 200 mm long



Description	Part no.
12-piece	82660L

## Body chisel

with hand protection, secured impact head



Length	Width	Part no.
240 mm	26 mm	94000L

## Body slot-type chisel set

- 1 wide body chisel 60 mm wide x 250 mm long, with heavy hand protection
- 1 narrow body chisel 26 mm wide x 230 mm long, with heavy hand protection
- 1 narrow body chisel 26 mm wide x 230 mm long, without hand protection
- 1 special body chisel 20 mm wide x 295 mm long, with extra thin tip, with space-saving light insulation

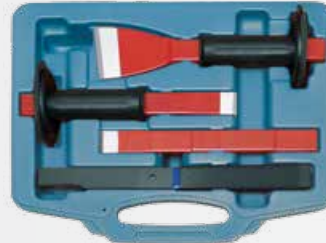

Description	Part no.
4-piece	94005L

## Body separating chisel set

single-piece blade and ergonomic handle. For cutting welding points on bodywork.

- 3 different shapes (straight, 15° angle, 90° angle)



Description	Part no.
3-piece	94006L
straight	94007L
15° angle	94008L
90° angle	94009L

## Set of steel stamping letters and numbers

alloy steel, 3 mm character height, complete from 0-9 and A-Z in a practical plastic case.



Description	Part no.
36-piece	08820L

## Steel stamping letters

for striking into steel an iron with consistent font, according to DIN 1451, engraving on offset surface and depth limitation



Description	Part no.
Letter height 3 mm	08800L
Letter height 4 mm	08801L
Letter height 5 mm	08802L
Letter height 6 mm	08803L
Letter height 8 mm	08804L
Letter height 10 mm	08805L



## Steel stamping numbers



for striking into steel an iron with consistent font according to DIN 1451, engraving on offset surface and depth limitation



Description	Part no.
Letter height 3 mm	08901L
Letter height 4 mm	08902L
Letter height 5 mm	08903L
Letter height 6 mm	08904L
Letter height 8 mm	08905L
Letter height 10 mm	08906L
Letter height 12 mm	08907L

## Punch set



in box, for making individual seals etc.

- 3 - 4 - 5 - 6 - 7 - 8 - 10 - 11 - 12 mm



Description	Part no.
9-piece	95080L

## Wad punch set



in pouch, painted, ground

- 3 - 5 - 7 - 9 - 10 - 13 - 16 - 19 - 22 mm



Description	Part no.
9-piece	95060L

## Wad punch set



in wooden case, painted, ground

- 2 - 4 - 6 - 8 - 10 - 12 - 14 - 16 - 18 - 20 mm



Description	Part no.
10-piece	95070L



## Wad punch



Painted, ground



Size	Length	Part no.
3 mm	105 mm	95003L
4 mm	105 mm	95004L
5 mm	110 mm	95005L
6 mm	110 mm	95006L
7 mm	123 mm	95007L
8 mm	123 mm	95008L
9 mm	123 mm	95009L
10 mm	132 mm	95010L
11 mm	132 mm	95011L
12 mm	133 mm	95012L
13 mm	140 mm	95013L
14 mm	140 mm	95014L
15 mm	140 mm	95015L
16 mm	140 mm	95016L
17 mm	148 mm	95017L
18 mm	148 mm	95018L
19 mm	148 mm	95019L
20 mm	160 mm	95020L
21 mm	160 mm	95021L
22 mm	160 mm	95022L
23 mm	170 mm	95023L
24 mm	170 mm	95024L
25 mm	170 mm	95025L
26 mm	180 mm	95026L
27 mm	180 mm	95027L
28 mm	180 mm	95028L
29 mm	190 mm	95029L
30 mm	190 mm	95030L
31 mm	190 mm	95031L
32 mm	190 mm	95032L
33 mm	190 mm	95033L
35 mm	197 mm	95035L
36 mm	197 mm	95036L
37 mm	197 mm	95037L
38 mm	197 mm	95038L
39 mm	197 mm	95039L
40 mm	197 mm	95040L
41 mm	197 mm	95041L
42 mm	197 mm	95042L
45 mm	197 mm	95045L
47 mm	197 mm	95047L
48 mm	197 mm	95048L
50 mm	197 mm	95050L

## Cotter Pin Drives / Pin Punches / Scribing Tools

### Pin punch



with impact-reducing "PRAXAGRIP-INSULATION"  
High wear-resistance, tempered punch heads



Size	Part no.
3 mm	82640L
4 mm	82641L
5 mm	82642L
6 mm	82643L
8 mm	82644L





## Pin punch



with impact-reducing "PRAXAGRIP-INSULATION"  
High wear-resistance, tempered punch heads



Size	Part no.
10 mm	82645L
12 mm	82646L
14 mm	82647L
16 mm	82648L

## Pin punch set



Chrome-vanadium, with tempered punch head

- 3 - 4 - 5 - 6 - 7 - 8 mm



Description	Part no.
6-piece in metal box	82620L
6-piece in plastic pouch	82630L

## Pin punch set



Chrome-vanadium, with hardened impact head

- 2 - 3 - 4 - 5 - 6 - 8 mm



Description	Part no.
6-piece in plastic holder	82625L

## Pin punch



Chrome-vanadium, with tempered punch head



Size	Part no.
2 mm	82600L
3 mm	82601L
4 mm	82602L
5 mm	82603L
6 mm	82604L
8 mm	82605L
10 mm	82606L
12 mm	82607L

## Pin punch



with extra-long mandrel, especially for brake pins



Description	Size	Length	Part no.
On 3 mm recessed tip	6 mm	175 mm	09030L
Special length for brake pins	4 mm	175 mm	09040L

## Drift punch

CrV 

Chrome-vanadium, with tempered punch head



Size	Part no.
3 mm	82650L
4 mm	82651L
5 mm	82652L
8 mm	82653L

## Centre punch

CrV 

Chrome-vanadium, with tempered punch head

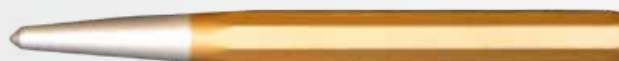

Size	Length	Part no.
12 mm	120 mm	94600L

## TCT marker



Pen form

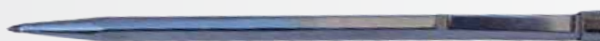

Length	Part no.
150 mm	80370L

## TCT marker



with pushbutton and retractable tip



Length	Part no.
150 mm	80380L

## TCT marker



Angled form



Length	Part no.
250 mm	80375L

## Rivet setter

CrV 

Chrome-vanadium

- Octagonal shaft
- Painted surface
- Uncoated head
- Bore diameter 2.5 mm



Size	Part no.
2 mm	42730L
3 mm	42731L
4 mm	42732L
5 mm	42733L
6 mm	42734L
8 mm	42735L
10 mm	42736L





## Rivet header



Chrome-vanadium

- Octagonal shaft
- Painted surface
- Uncoated head
- Bore diameter 3.5 mm



Size	Part no.
2 mm	42740L
3 mm	42741L
4 mm	42742L
5 mm	42743L
6 mm	42744L
8 mm	42745L
10 mm	42746L

## Bar Clamps

### Bar clamp



with 120 mm overhang  
Heavy-duty version with zink-plated rail



Length	Depth	Part no.
290 mm	120 mm	73401L
490 mm	120 mm	73402L

## Grease Guns / Cartridge Press

### Mini grease gun including grease bag



SW-Stahl mini grease gun, including a grease tube (80 g) for filling the grease gun.

- ideal tool for regular maintenance on striking mechanism of impact wrenches
- supports the long life cycle of impact wrenches
- easy handling
- suitable for nearly every kind of impact wrench



Description	Part no.
2-piece	64311L

### SW-Stahl High performance grease



High-quality lithium-calcium grease for the lubrication of compressed-air impact screwdrivers. Suitable for utilization at increased temperatures and extreme pressure loading. EP additives provide for optimal lubricating quality even in the presence of up to 20% water.

Temperature application range: - 30°C to +130°C.  
Identification in accordance with DIN 51502: KP2K-30.



Part no.
64311L-F

## Hand-lever grease press

with up to 10,000 psi pressure, with pressure valve for draining air bubbles, suitable for filling with cartridges or bulk grease



Description	Part no.
Standard press with nozzle pipe and hydraulic mouthpiece	64301L
Reinforced hose 300 mm incl. 4-jaw mouthpiece	64302L
Hydraulic mouthpiece	64305L
Nozzle pipe	64304L

## Single-handed grease gun

with up to 10,000 psi pressure, with bleeding screw, suitable for filling either with cartridges (400 / 220 mm) or bulk grease, with nozzle pipe and hydraulic mouthpiece



Part no.  
64310L

## Pneumatic grease gun

volume 400 ccm, complete with

- nozzle pipe
- hydraulic mouthpiece
- reinforced hose

① suitable for cartridges

Working pressure min/max:  
max. 8 bar



Part no.  
64350L

## Battery-operated grease gun

12 Volt - 3-way insert:

- standard grease cartridges + hose + pump / direct filling
- maximum working pressure / load capacity: 420 bar / 6,000 psi
- 750 mm flexible outlet hose with metal protection
- lockable trigger
- battery charge state display
- 12 V / 1.7 Ah NiCd rechargeable battery
- fast charger
- incl. spare battery 12 V
- capacity of the grease cartridge: 400 g
- amount pumped: 80 g/min at 70 bar

① Independent of the power supply, thus ideal for the lubrication of machines and vehicles in mobile use



Description	Part no.
Set	64340L
Replacement battery	64340L-1



## Grease gun accessories set

- 90° lubricating agent attachment
- straight extension
- 300 mm hose extension
- 90° adapter
- rubber lubricating tip
- needle tip
- 360° adapter



Description

7-piece

Part no.

64315L

## Reinforced hose

for hand-lever grease presses with M10 x 1 threaded receptacle.



Description

Reinforced hose 300 mm incl. 4-jaw mouthpiece

Part no.

64302L

## Hydraulic mouthpiece

for hand-lever grease presses, 4-jaw



Part no.

64305L

## Cartridge press

for all standard cartridges (220 mm)



Part no.

24000L

## Cartridge press

open model for all standard cartridges (220 mm)



Part no.

24010L

## Cartridge press

with aluminium cylinder, for standard 220 mm cartridges and bag



Part no.

24020L

## Foam gun



for standard PU foam cartridges

- simple handling thanks to low gun weight
- exact dosing without drips
- fill joints and cavities precisely
- cartridges can remain screwed onto the foam gun even when work is interrupted



Part no.  
21515L

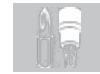

## Pullers

### Universal remover set



with forged jaws, can be reversed for inner and outer

- 2-arm, 75 mm
- 3-arm, 100 mm
- 3-arm, 150 mm



Description  
3-piece

Part no.  
10405L

### Remover, universal



2-arm - with forged jaws, can be reversed for inner and outer

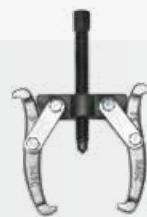

Clamping width  
75 mm  
100 mm  
150 mm

Part no.  
09510L  
09515L  
09525L

### Remover, universal



3-arm - with forged jaws, can be reversed for inner and outer



Clamping width  
100 mm  
150 mm

Part no.  
09615L  
09620L



## Remover



with fine-threaded spindle, forged,

- reversible for inner and outer
- parallel pull-off hooks in every position

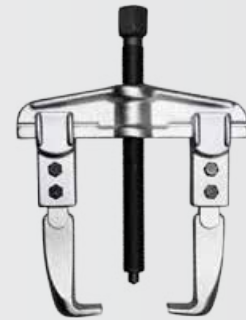

Clamping width	Clamping depth	Part no.
90 mm	100 mm	09550L
130 mm	100 mm	09551L
160 mm	150 mm	09552L
200 mm	150 mm	09553L
250 mm	200 mm	09554L

## Universal remover



Chrome-vanadium steel with forged jaws

- can be used with 2 or 3 arms
- can be reversed for inner and outer
- innovative spring mechanism for simple conversion



Clamping width	Clamping depth	Part no.
76 - 102 mm	100 mm	10402L
76 - 178 mm	180 mm	10403L

## Universal removal tool set



with quick-change function and locking of the arms, can be used with 2 or 3 arms.

- can be used as inner and outer removal tool
- interchangeable bases
- span width from 50 - 100 mm
- 100 - 170 mm clamping depth



ⓘ Save time with quick change!

Description	Part no.
8-piece	09691L

## Remover set



forged, chrome-molybdenum steel, 2 and 3-arm can be used

- 100 - 200 - 250 mm span width
- can be used as inner and outer remover
- replaceable, hardened remover bases (ca. 25 mm)
- span width max. 130 mm



Description	Part no.
12-piece	09690L
Replacement claw	09690L-1



## Remover set

Hydraulic, 10 t, can be used as 2 and 3-arm remover as well as a separating tool up to 105 mm, forged jaws, polished remover clips, spindle extension with centring tip,

- 100 mm arms
- 150 mm arms
- 200 mm arms
- spindle extension 20, 35 mm and 85 mm
- hydraulic spindle for many remover systems applicable



Description	Part no.
Remover set 10 t	<b>09680L</b>
Cutting blades 75 to 105 mm	<b>10002L</b>
Hydraulic spindle, max, 12 t	<b>09681L</b>

## Hydraulic spindle

Hydraulic spindle 12 t, compatible with many extractor systems, external thread, Whitworth 55° (37 mm x 1.6) 16G10 (3/8")



① Replacement to 09680L

Part no.
<b>09681L</b>

## Inner bearing puller set

Inner bearing puller set and case  
With spreader arms from 8 - 33 mm for universal use.  
The impact weight makes it easier to pull out fixed bearings



Description	Part no.
11-piece	<b>09665L</b>

## Spreading sleeve

from the set 09665L



Length	Diameter max.	Diameter min.	Thread	Part no.
110 mm	11 mm	8 mm		<b>09665L-3</b>
129 mm	17 mm	12 mm		<b>09665L-4</b>
131 mm	23 mm	18 mm		<b>09665L-5</b>
131 mm	29 mm	24 mm		<b>09665L-6</b>
131 mm	34 mm	30 mm		<b>09665L-7</b>
50 mm			M10	<b>09665L-8</b>
50 mm			M8	<b>09665L-9</b>
50 mm			M6	<b>09665L-10</b>



## Remover set



for differential, ball bearing, small toothed wheels and belt pulleys



Description  
15-piece

Part no.  
09650L

## Remover set



for lock-rings, ball bearings etc.  
3-arm inner and outer remover with impact weight

Inner remover:

- 34 - 110 mm
- 26 - 110 mm
- 36 - 110 mm

Outer remover:

- 30 - 110 mm
- 21 - 110 mm
- 15 - 110 mm



Description  
5-piece

Part no.  
09660L

## Cutting off plate cylinder



Universal, for span widths from 32 to 78 mm  
and clamping depths from 75 mm to 105 mm

Ideal for thin-walled V-belt pulleys, ball bearings, roller bearings, discs, bushings, pinions etc.

Closely fitting parts are loosened safely from their seat by pressing the separating jaws together



Description  
14-piece  
Cutting blades 30 to 50 mm  
Cutting blades 75 to 105 mm

Part no.  
09675L  
10001L  
10002L

## Ball-joint extractor



For removing the ball joints from the steering knuckle, e.g. Steering rod, stabilizer and the like.

- clamping height up to 50 mm
- fork opening 20 mm



Description  
Short fork, fine thread spindle  
Long fork, fine thread spindle

Part no.  
10005L  
10006L

## Ball-joint remover

for pushing the ball pin out when removing ball joints from the stabiliser, steering knuckle, steering lever etc.

- Clamping range up to 55 mm
- Width 22 mm



Audi  
BMW  
Fiat  
Ford  
Mercedes-Benz  
Nissan  
Opel  
Peugeot  
Renault  
Rover  
Saab  
Seat  
Škoda  
Toyota  
Volvo  
VW

### Description

Clamping range can be adjusted in 2 fixed stages, 30 + 55 mm, with fine-thread spindle

### Part no.

10008L

## Ball-joint remover

Extra large, forged, universally applicable for trucks. The fork extension serves to drive the tool with a targeted hammer strike.

- Fork opening 20 mm



### Description

Extra large with fork extension

### Part no.

10007L

## Ball-joint remover set

with fine-thread spindles

- E23 x H55
- E28 x H55
- E34 x H63



Mercedes-Benz  
VW  
Audi  
Fiat

ⓘ Especially suitable under cramped conditions

### Description

3-piece

### Part no.

10015L

23 mm wide, 55 mm useful height, for almost all passenger cars, particularly BMW E39 and MB W210

10010L

28 mm wide, 55 mm useful height especially for Audi A4, A6, A8, VW Passat etc., Opel Movano, MB W203

10011L

34 mm wide, 63 mm useful height especially for VW"LT" from model year 96, Mercedes-Benz Sprinter from model year 95, VW"T4", Fiat Ducato etc.

10012L

## Ball joint remover set

with interchangeable fork system, allows disassembly of ball joints in various sizes.

- Suitable for cars, light trucks and SUVs
- 5 interchangeable forks 20-22-24-27-30 mm
- Max. extractor width 125 mm



ⓘ Heavy duty version

### Description

6-piece

### Part no.

10019L



## Ball-joint remover



for universal use with trucks/commercial vehicles

- with two seats 24 + 32 mm width
- with oil hydraulic spindle for easy and fast work
- clamping range: 55 105 mm



ⓘ **Warning: Clean and lubricate the screw with grease (MOS2), before using it.**

Description	Part no.
24 + 32 mm width	<b>10004L</b>







# AIR TOOLS



# AIR TOOLS

## 238-257



▶ Compressor	240
▶ Impact Wrenches	241-243
▶ Ratchet Wrenches	244-245
▶ Blasting Guns	245-246
▶ Die Grinders	246
▶ Cutt-Off Tool	247
▶ Vibro Impact Air Hammers	247-248
▶ Body Air Tools	248-250
▶ Other Air Tools	251-252
▶ Air Tool Accessories	253-257





## Piston compressor

- V-belt powered 2-cylinder serial power unit
- includes a pressure reducer for setting an exact delivery pressure
- start up relief via a Condor MDR 2 pressure switch
- with large profiled, ball bearing hard rubber wheels
- condensate discharge takes place by means of a ball cock



Suction capacity	Pressure vessel capacity	Part no.
360 l/min	50 l	25200L

## Piston Compressor

- V-belt powered 2-cylinder, single step power unit
- start up relief via the pressure switch control
- with large profiled, ball bearing hard rubber wheels and castor wheels for simple handling
- condensate discharge takes place by means of a ball cock
- scope of delivery includes a phase changing plug



Suction capacity	Pressure vessel capacity	Part no.
600 l/min	90 l	25201L

## Piston Compressor

- V-belt powered 2-cylinder serial power unit
- start up relief via a Condor MDR 2 pressure switch
- with large profiled, ball bearing hard rubber wheels
- condensate discharge takes place by means of a ball cock
- scope of delivery includes a phase changing plug
- 2 castor wheels on the front for perfect handling



Suction capacity	Pressure vessel capacity	Part no.
780 l/min	90 l	25202L

## Piston Compressor

- V-belt powered 2-cylinder, single step power unit
- start up relief via a Condor pressure control switch
- with large profiled, ball bearing hard rubber wheels and castor wheels for simple handling
- condensate discharge takes place by means of a ball cock



Suction capacity	Pressure vessel capacity	Part no.
600 l/min	200 l	25203L

## Piston Compressor

- space-saving compressed air tank (standing embodiment)
- slow-running 2 cylinder serial power unit with a high level of effectiveness
- large-size suction air filter
- incl. a damper set for vibration-free operation
- condensate discharge takes place by means of a ball cock



Suction capacity	Pressure vessel capacity	Part no.
690 l/min	270 l	25204L



## Vibration pneumatic impact screwdriver



6.3 mm (1/4") drive

Especially for the removal of jammed glow elements through several impact pulses and 4-stage adjustable loosening torque.

- extra small and handy
- right/left direction of rotation
- quick-action coupling
- loosening torque from 20 to 50 Nm
- weight 2.12 kg
- hose connection: 6,3 mm (1/4")
- sound pressure: 95 dB (A)
- 5 IMPACT hexagon sockets 50 mm long, 8–9–10–11–12 mm
- extension 50 mm
- power joint 6,3 mm (1/4")

Loosening torque adjustable in 4 stages:

- stage 1: 20 Nm
- stage 2: 30 Nm
- stage 3: 40 Nm
- stage 4: 50 Nm



### Description

8-piece

### Part no.

S3224

## Pneumatic impact wrench



12.5 mm (1/2") drive

In spite of the impact wrench having a quite short headroom (98 mm), it has enough power to carefully loosen the screws and nuts. The wrench can also be used in cramped spaces.

- high performance twin hammer mechanism
- fatigue-proof work due to extremely low net weight
- single-handle switching for clockwise/ anticlockwise running
- very low vibration
- threefold torque selection
- with a non-slip handle
- 1/4" inlet nipple included



### Maximum loosening torque

1172 Nm

### Length

98 mm

### Weight

1,11 kg

### Part no.

S3249

## Pneumatic stubby impact wrench



12.5 mm (1/2") drive

Ideal for loosening the high-tensile fitting of half-shaft screws on single sided swing arms of motorcycles, especially Ducati and MV Agusta.

- very short design
- high performance twin hammer mechanism
- fatigue-proof work due to extremely low net weight
- very quiet
- very low vibration
- with a non-slip handle
- 1/4" inlet nipple included



### Maximum loosening torque

1300 Nm

### Length

120 mm

### Weight

1,5 kg

### Part no.

S3284





## Pneumatic impact wrench



12.5 mm (1/2") drive

- high performance twin hammer mechanism
- fatigue-proof work due to extremely low net weight
- single handed switching for clockwise / anticlockwise running
- very low noise
- very low vibration
- threefold torque selection
- with a non-slip handle
- 1/4" inlet nipple included



Maximum loosening torque	Length	Weight	Part no.
1300 Nm	153 mm	1,2 kg	S3275



## Pneumatic impact wrench

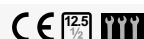

12.5 mm (1/2") drive

- high performance twin hammer mechanism
- fatigue-proof work due to extremely low net weight
- single handed switching for clockwise / anticlockwise running
- very low noise
- very low vibration
- threefold torque selection
- with a non-slip handle
- 1/4" inlet nipple included



Maximum loosening torque	Length	Weight	Part no.
1756 Nm	183 mm	1,9 kg	S3276



## Pneumatic impact wrench



20 mm (3/4") drive

- pistol design
- high performance twin hammer mechanism
- very light aluminium casing
- very low noise
- low-vibration
- threefold torque selection
- with a non-slip handle
- 3/8" inlet nipple included



Maximum loosening torque	Length	Weight	Part no.
3200 Nm	215 mm	3,40 kg	S3277



## Pneumatic impact wrench



25 mm (1") drive

- pistol design
- high performance twin hammer mechanism
- aluminium casing very low in weight
- very quiet
- low-vibration
- threefold torque selection
- with a non-slip handle
- 3/8" inlet nipple included



Maximum loosening torque	Length	Weight	Part no.
3200 Nm	223 mm	3,50 kg	S3278



## Light Duty pneumatic impact wrench



25 mm (1") drive

- short anvil
- high performance twin hammer mechanism
- aluminium casing very low in weight
- low-vibration
- threefold torque selection
- 1/2" inlet nipple included



Maximum loosening torque

Length

Weight

Part no.

3800 Nm

378 mm

6,3 kg

S3279

## Light Duty pneumatic impact wrench



25 mm (1") drive

- long anvil 210 mm (8,3")
- high performance twin hammer mechanism
- aluminium casing very low in weight
- low-vibration
- threefold torque selection
- 1/2" inlet nipple included



Maximum loosening torque

Length

Weight

Part no.

3800 Nm

547 mm

7,2 kg

S3280

## Magnetic stand for tyre station



for tyre station, for attachment to lifting platforms and all metallic surfaces.

Avoids damage to the impact wrench, torque wrench and compressed air hoses caused by them being dropped on the floor.

Conversion times are reduced.

The risk of injury caused by compressed air hoses lying about is reduced.



ⓘ Carrying force 25 kg

Part no.

07395L

## Mini grease gun including grease bag



SW-Stahl mini grease gun, including a grease tube (80 g) for filling the grease gun.

- ideal tool for regular maintenance on striking mechanism of impact wrenches
- supports the long life cycle of impact wrenches
- easy handling
- suitable for nearly every kind of impact wrench



Description

2-piece

Part no.

64311L

## Pneumatic ratchet wrench

- ratchet head protected against dirt
- easy to switch (left / right)
- fatigue-proof work as a result of extremely low net weight
- very quiet
- rear exhaust
- cold insulated and anti-slip handle
- very low-vibration
- 1/4" inlet nipple included



Drive	Maximum Torque	Length	Weight	Part no.
6.3	41 Nm	196 mm	0,5 kg	S3281
10	41 Nm	196 mm	0,5 kg	S3282

## Pneumatic ratchet wrench

12.5 mm (1/2") drive

- ratchet head protected against dirt
- easy to switch (left / right)
- fatigue-proof work as a result of extremely low net weight
- very quiet
- rear exhaust
- cold insulated and anti-slip handle
- very low-vibration
- 1/4" inlet nipple included



Drive	Maximum Torque	Length	Weight	Part no.
12.5	68 Nm	256 mm	1,2 kg	S3283

## Pneumatic ratchet wrench

12.5 mm (1/2") drive, with rubberised handle  
incl. 6.3 mm (1/4") pneumatic plug nipple



Drive	Maximum Torque	Length	Weight	Part no.
12.5	108 Nm	286 mm	1,33 kg	S3283

## Pneumatic ratchet wrench set

12.5 mm (1/2") drive

- 7 IMPACT hexagon sockets 10 - 11 - 12 - 13 - 15 - 17 - 19 mm
- 1 bit adapter
- 3 screwdriver bits (slot 5,5 mm, PH2, PH3)
- 1 extension 75 mm
- Incl. oil
- maximum torque: 74 Nm
- right and left hand rotation
- with quick-action coupling
- weight of ratchet screwdriver: 1,2 kg
- air consumption: 113 l/min
- hose connection: 6.3 mm (1/4")



Description	Maximum Torque	Length	Part no.
15-piece	74 Nm	278 mm	S3230

## Magnetic stand for tyre station



for tyre station, for attachment to lifting platforms and all metallic surfaces.

Avoids damage to the impact wrench, torque wrench and compressed air hoses caused by them being dropped on the floor.

Conversion times are reduced.

The risk of injury caused by compressed air hoses lying about is reduced.



ⓘ Carrying force 25 kg

Part no.  
07395L



## Blasting Guns

### Blasting gun

made of high-grade diecast aluminum



Part no.  
25010L

### Blasting gun

made of seamless, chrome-plated steel tube, handle made of blue nylon fibre, (1/4") inner thread



Length  
1000 mm  
325 mm  
250 mm  
100 mm

Part no.  
21514L  
21516L  
21517L  
21518L



## Blow-out pin



Can be connected directly to the air coupling.

- with clip
- extremely handy and ready readily available at all times
- extremely narrow outlet e.g. for blowing out lines
- pressure can be infinitely adjusted



① **Ideal for the smock bag.**

Max. operating pressure	Air flow rate	Length	Part no.
12 bar	at 6 bar approx. 300 l/min	110 mm	25015L

## Rubber blow-out pin



for simple operation by simply slightly bending the rubber tip, for use in places that are difficult to access e.g. when blowing the engine dry after an engine wash or for painted spots.

- very handy
- 80 mm long
- max. operating pressure 10.3 bar
- 6.3 mm (1/4") inner thread



Max. operating pressure	Length	Part no.
10,3 bar	80 mm	25016L

## Magnetic holder



for blasting guns, so they are always on hand at the workstation, e.g. at the lifting platform.



Part no.  
21519L

# Die Grinders

## Pneumatic axial grinder set



Ultra compact, with 10 grinding stones and oil spray device. For use in spots that are difficult to access, for machining intake ducts etc. in the tuning sector.

- axis diameter of the grinding and milling heads 3 mm
- only 135 mm long (without hose), 16 mm diameter
- very low in weight – less than 200 g (without hose)



Description	Speed	Working pressure min/max:	Air consumption	Compressed air connection	Part no.
17-piece	54.000 rpm	6,3 bar	143 l/min	1/4 Zoll	S3263

## Pneumatic axial grinder



for grinding, milling, deburring etc., with 6 mm collet chuck

- Inc. 6.3 mm (1/4") pneumatic connection incl. plug nipple
- max. 22,000 rpm
- exhaust air outlet at the rear
- safety lever prevents unintentional switch-on



Description	Working pressure min/max:	Air consumption	Compressed air connection	Part no.
Straight	6,3 bar	126 l/min	1/4 Zoll	S3260
Bent 90°	6,3 bar	99 l/min	1/4 Zoll	S3265
Replacement chuck				S3261

## Pneumatic angle grinder



Extra long, flat head for 100 mm grinding wheel size.

- recommended hose size 3/8"
- vibration 0.6 m/s<sup>2</sup>
- grinding wheel adapter 16 mm



① Suitable cutting disc see!

Description	Idle speed	Part no.
Angle grinder	14.000 rpm	<b>S3268</b>
Cutting disc Ø 100 mm	max. 15.280 rpm.	<b>9600-M</b>

## Vibro Impact Air Hammers

### Pneumatic chipping hammer



with 4 different chisels, compressed air coupling and pressure adjustment screw

- pneumatic chipping hammer 150 mm with retaining spring
- working pressure 6,2 bar (90 psi)
- air consumption 113 l/min
- compressed air connection 1/4"
- blow count 3000/min
- 4 pneumatic chisels
- automatic oiler
- hose adapter
- oil can



Description	Working pressure max:	Air consumption	Part no.
8-piece	6,2 bar	113 l/min	<b>S3213</b>

### Vibro pneumatic chisel set



contains 4 different impact chisels with different profiles. ideal for support e.g.:

- when loosening nuts and screw connections which have rusted tight
- for pressing the supporting joint cone out of the rear axle
- with rust solvents, since they penetrate deeper due to the vibration
- incl. compressed air nipple 1/4"
- with quick-action chuck
- with backlash damping
- stroke rate: 2100/min.
- chisel shaft: around 10 mm
- working stroke: 10 mm
- working pressure: 6.2 bar



Description	Blow count	Working pressure max:	Part no.
8-piece	2100/min	6,2 bar	<b>S3211</b>



## Needle scaler attachment

The needle scaler attachment is used for the removal of coatings on solid metal parts. With the metal needles it is the perfect tool to get rust off rims, frame parts or iron fences. Additionally you easily are able to remove paint, plastering or cement.

The needle scaler is an attachment to pneumatic chippings from sets S3211 and S3213.

Main features:

- 19 needles with diameter 2,8 mm each
- diameter of inner stud 10,1 mm
- diameter of support thread ~ 30,5 mm



Part no.  
**S3215**

## Body Air Tools

### Pneumatic air underbody protection gun



suitable for all standard cartridges, with cavity hose 500 mm



ⓘ Clean thoroughly after each use!

**Air consumption**

300 l/min

Part no.

**25050L**

### Pneumatic air bodywork saw



for use with jigsaw blades for sawing various materials such as metal, plastic, rubber and wood. For processing these materials, sawblades with different tooth pitches are available.

- stroke frequency: 9,000 rev./min
- construction length: 235 mm
- weight: 770 g
- air consumption: 120 l/minute
- operating pressure: 6.3 bar
- sound pressure level: 72.0 dB (a)
- acceleration: 26.0 m/s<sup>2</sup>
- max. cutting output: 1.2 mm



ⓘ Delivery incl. 2 sawblades 70624L (24 teeth)

**Working pressure**

max. 6,3 bar

**Air consumption**

120 l/min

**Length**

235 mm

**Part no.**

**40008L**



## Pneumatic glazing remover



inc. standard straight blade

- 57 mm long
- 20,000 rpm
- air consumption 113l/min.
- with 6,3 mm (1/4") pipe connection
- weight only ca. 1,150g

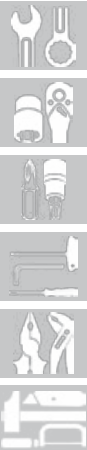

Description	Working pressure max:	Air consumption	Part no.
Complete unit	6,3 bar	113 l/min	40003L
1 straight replacement blade, 57 mm			400030L

## Pneumatic beating hammer



A vacuum is created, which causes the device to stick to the body, allowing dents to be pulled out easily using the hammer.

- 3 replaceable suction cups 60, 120, 155 mm diameter
- 1,500 g impact weight
- ca. 620 mm long
- 1/4" pressure connection
- up to 100 kg pull-off force



<b>Working pressure max:</b>		<b>Part no.</b>
6-8 bar		23045L

## Pneumatic spot weld cutter



with removable clamp for spots that are difficult to access and automatic drill advance, cutting depth can be adjusted infinitely on the ring in steps of 0.05 mm. This means the second sheet is not drilled through, and reworking is not necessary.

inc. 3 x 8 mm cutter drill



Speed	Working pressure max:	Air consumption	Part no.
1600 rpm	6,3 bar	220 l/min	40020L

## Pneumatic hole and edge setting tool



ideal and fast tool for preparing spot welding work. Hole punching and setting is all done with a single tool.

- hole diameter 5 mm
- rebate width 22 mm
- rebate depth 12 mm
- max. sheet thickness: 1,5 mm

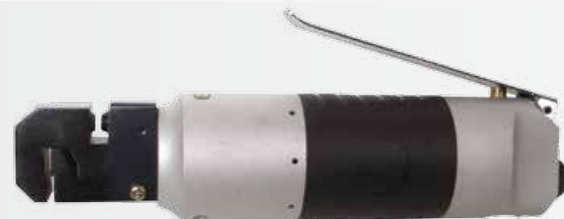

Working pressure max:	Air consumption	Length	Part no.
6,3 bar	113 l/min	270 mm	93020L





## Needle scaler attachment

The needle scaler attachment is used for the removal of coatings on solid metal parts. With the metal needles it is the perfect tool to get rust off rims, frame parts or iron fences. Additionally you easily are able to remove paint, plastering or cement.

The needle scaler is an attachment to pneumatic chippings from sets S3211 and S3213.

Main features:

- 19 needles with diameter 2,8 mm each
- diameter of inner stud 10,1 mm
- diameter of support of thread ~ 30,5 mm



Part no.  
**S3215**

## Pneumatic spray gun

top can model, 600 cm<sup>3</sup>, nozzle 1.5 mm  
with universal spraying head: round, wide, flat



Max. operating pressure

Air flow rate

Part no.

4 bar

370 l/min

**25000L**

## Pneumatic painting gun

compact version 120 ccm.

- aluminium housing
- chrome-plated finish
- PP tank 120 ccm, with filter
- rustproof spraying head (0.8 mm)
- EURO quick-action pneumatic connection



Max. operating pressure

Air flow rate

Part no.

2 - 3,5 bar

226 l/min

**25005L**

## Pneumatic spray gun

with cup, 0.6 l volume, suitable for

- Solvents
- Rust protection agents
- Lubricants and cleaning agents



Max. operating pressure

Air flow rate

Part no.

8 bar

330 l/min

**25020L**

## Pneumatic spray gun

Can be used for cleaning agents and solvents, with flexible outlet to allow problematical working areas to be reached



Max. operating pressure

Air flow rate

Part no.

8 bar

330 l/min

**25055L**

## Pneumatic grease gun

volume 400 ccm, complete with

- nozzle pipe
- hydraulic mouthpiece
- reinforced hose

① Also suitable for cartridges!



Working pressure max:

max. 8 bar

Part no.

64350L

## Pneumatic pump

for oil barrels, for the extraction of motor oil from barrels

- Following connection to a compressor, pressure is built up in the barrel, causing the oil to be expelled
- suitable for barrels up to 200 litres capacity
- including different hoses
- automatic interruption in operation through safety valve
- inc. extension hose for refilling or pumping off liquids under extremely cramped conditions



Description

30 l/min output

Working pressure min/max:

2,1 - 6,2 bar

Air consumption

85 l/min

Part no.

08480L

## Pneumatic oil filter removal aid

for the clean removal of oil filters

- quick and efficient thanks to pneumatic technology
- Avoidance of unnecessary special waste for disposal
- no oil residue that can often not be avoided despite careful cleaning

### Contents:

- Pneumatic nailer with installation needle
- Magnetic holder
- Hose with brass grommet
- 20 replacement valves

### Advantages:

- Fast and clean dismantling
- Saves costs and goes easy on the environment
- Customer complaints on the subject of dripping oil residue are avoided



**Description**  
Complete set

**Part no.**  
08490L

## Pneumatic sandblasting gun

CE 

Heavy-duty ABS housing

- Blasting sand tank capacity 600 cm<sup>3</sup>
- for use with regular aluminium oxide grit F46 to F100
- air connection 6.3 (1/4")
- Air consumption 3.3 litres / second
- 5 mm steel tip
- With compressed air connection



**Part no.**  
25070L

## Pneumatic sandblasting gun

CE 

ideal for numerous applications on vehicle bodies and all metallic surfaces. For the removal of old paint, rust, heavy soiling with 4 different blasting fittings and a template for precise spot blasting, e.g. in the case of gravel throw damage

- for 6.3 mm (1/4") compressed air hoses
- working pressure 4 - 12 bar
- air consumption max. 350 l/min

- I = 15 mm
- II = 13 x 13 mm
- III = 15 x 15 mm
- IV = 13 x 15 mm



 Use with standard blasting sand.

**Description**  
Sandblasting gun, complete  
Replacement granulate bag

**Part no.**  
25065L  
25066L

## Magnetic stand for tyre station

for tyre station, for attachment to lifting platforms and all metallic surfaces.

Avoids damage to the impact wrench, torque wrench and compressed air hoses caused by them being dropped on the floor.

Conversion times are reduced.

The risk of injury caused by compressed air hoses lying about is reduced.

① Carrying force 25 kg



Part no.  
07395L

## Magnetic holder

for blasting guns, so they are always on hand at the workstation, e.g. at the lifting platform.



Part no.  
21519L

## Pneumatic Maintenance Unit

The pneumatic air maintenance unit consists of pressure regulator, moisture separator and oil-mist lubricator, and thus offers a complete maintenance unit for your pneumatic tools. Two independent extraction points with quick coupling reliably supply filtered and dry compressed air, for example for spray guns, or additionally oiled compressed air, for example for impact wrenches. In this way you achieve optimum conditions for the tools in use and extend their service life.

- maximum air pressure in the intake: 15 bar
- maximum temperature: 60°C (at maximum pressure)
- filter insert: 10 µ
- adjustment range of the regulator : 0.5 to 11 bar
- adjustment range of the oil-mist lubricator: 1 drop every 300 to 600 l/min.
- Max. throughput quantity: 3,100 l/min



Part no.  
25029L

## Pressure regulator

with digital display, for compressors

- continually adjustable from 0.2 - 11 bar
- protects pneumatic tools by reducing compressor pressure
- can be attached to the tool or air distributor / compressor



Part no.  
25048L

## Automatic oiler

with 6.3 mm (1/4") thread connection



Part no.  
25046L



## Waste air hose



for pneumatic tools with 6.3 mm (1/4") hose connection.

- keeps cold, soiled and oily air away from the fitter and the vehicle
- reduces noise level

The waste air hose is simply inserted between the tool and the pneumatic connection. The plastic sleeve is then pulled over the handle (warm a little if necessary). This means the waste air flowing through the handle is discharged through the hose.



**Length**

500 mm

**Part no.**

**25039L**

## Pneumatic air hose



(transparent) with fabric lining, coupling and plug nipple (DN 7.2 brass) prefitted.

- Maximum operating pressure: 15 bar
- Fabric lining: Polyester threads
- Operating temperature: -20°C to +60°C
- Without cadmium or silicon
- Age and UV-resistant



**Inner diameter**

6 mm

**Length**

5 m

**Part no.**

**25091L**

6 mm

10 m

**25092L**

## Pneumatic air hose



(transparent) with fabric lining, coupling and plug nipple (DN 7.2 brass) prefitted

- Maximum operating pressure: 15 bar
- Fabric lining: Polyester threads
- Operating temperature: -20°C to +60°C
- Without cadmium or silicon
- Age and UV-resistant



**Inner diameter**

9 mm

**Length**

5 m

**Part no.**

**25093L**

9 mm

10 m

**25094L**

## Pneumatic air hose



(transparent) with fabric lining, coupling and plug nipple (DN 7.2 brass) prefitted

- Maximum operating pressure: 10 bar
- Fabric lining: Polyester threads
- Operating temperature: -20°C to +60°C
- Without cadmium or silicon
- Age and UV-resistant



**Inner diameter**

13 mm

**Length**

10 m

**Part no.**

**25095L**

## Pneumatic air hose



in soft technology with cross-woven lining, 3-ply. Coupling and plug nipple (DN 7.2 steel) pre-fitted.

Immense flexibility and resilience, even at low temperatures. Low weight and high compressive strength. The steel compressed air connections are more durable than those made of brass.

- Maximum operating pressure: 15 bar
- Fabric lining: Polyester threads
- Operating temperature: -20°C to +60°C
- Oil and petrol-repellent
- Without cadmium or silicon
- Extra soft and dimensionally stable
- Age and UV-resistant
- TÜV-tested



Inner diameter	Length	Part no.
9 mm	5 m	25096L
9 mm	10 m	25097L
9 mm	20 m	25098L

## Pneumatic helical hose



with nickel-plated quick couplings.

- internal hose diameter: 10 mm
- external hose diameter: 14 mm
- total length (extended): 10 m
- material: Polyurethane
- working pressure: 6.9 bar / 100 psi
- bursting pressure: 20.7 bar / 300 psi
- connecting thread: 10 mm (3/8")



Inner diameter	Outer diameter	Length	Part no.
10 mm	14 mm	10 m	25051L

## Pneumatic helical hose



with quick-action couplings



Inner diameter	Outer diameter	Length	Part no.
6 mm	8 mm	10 m	25040L

## Pneumatic air hose



with quick-action couplings



Inner diameter	Outer diameter	Length	Part no.
6 mm	10 mm	10 m	25045L





## Winding drum for pneumatic hose



suitable for wall and ceiling mounting, pvc hose with adjustable hose stopper.

- hose pull-out can be locked every 0.1 m
- 0,5 m hose mounting
- 15 m useful hose
- complete with 1/4" quick-action couplings
- with automatic reeling
- inner diameter of the hose: 12,5 mm
- outer diameter of the hose: 18,8 mm



Description	Max. operating pressure	Inner diameter	Outer diameter	Part no.
15 m	20 bar	12,5 mm	16 mm	25061L

## Pneumatic air hose drum



with 30 m pneumatic air hose

- inner diameter 8 mm
- outer diameter 12 mm
- 6.3 mm (1/4") compressed air connection
- on platform rotatable through 360°



Inner diameter	Outer diameter	Part no.
8 mm	12 mm	25047L

## Pneumatic quick coupling, one-hand operation



DN 7.2, with outer thread

- brass
- with non-return valve
- nominal flow: 1300NI/min (at 6 bar preliminary pressure and drop in pressure of 1 bar)



External screw thread	Part no.
3/8 inch	25080L
1/2 inch	25081L

## Pneumatic quick coupling, one-hand operation



DN 7.2, with internal thread

- Brass
- With non-return valve
- Nominal flow: 1300NI/min (at 6 bar pre-pressure and 1 bar pressure loss)

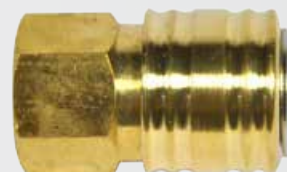

Internal screw thread diameter	Part no.
1/4 inch	25082L

## Pneumatic quick coupling, one-hand operation



DN 7.2, with hose nozzle

- Brass
- With non-return valve
- Nominal flow: 1300NI/min (at 6 bar pre-pressure and 1 bar pressure loss)



Outer diameter	Part no.
6 mm	25044L
9 mm	25083L
13 mm	25084L



## Pneumatic air plug nipple



DN 7.2, with external thread

- Brass
- Nominal flow: 1300NI/min (at 6 bar pre-pressure and 1 bar pressure loss)



External screw thread

1/4 inch  
3/8 inch  
1/2 inch

Part no.

25043L  
25085L  
25086L

## Pneumatic air plug nipple



DN 7.2, with internal thread

- Brass
- Nominal flow: 1,300NI/min (at 6 bar pre-pressure and 1 bar pressure loss)



Internal screw thread diameter

1/4 inch

Part no.

25087L

## Pneumatic air plug nipple



DN 7.2, with hose nozzle

- Brass
- Nominal flow: 1300NI/min (at 6 bar pre-pressure and 1 bar pressure loss)



Outer diameter

6 mm  
9 mm  
13 mm

Part no.

25088L  
25089L  
25090L

## Pneumatic air plug nipple



DN 5.5, with external thread

- Nickel-plated brass
- Nominal flow: 700NI/min (at 6 bar pre-pressure and 1 bar pressure loss)



ⓘ Swiss standard, also used in the Netherlands!

External screw thread

1/4 inch

Part no.

25049L

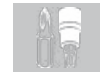

# POWER / CORD- LESS TOOLS





# POWER / CORDLESS TOOLS

## 258-267



▶ Cordless Battery Tools

260-261



▶ Induction Heater

261-265



▶ Battery Charger

265-267



▶ Hot Air Blower

267



▶ Hot-Melt Gun

267





## Cordless Drill / Driver



Chuck capacity 10 mm, 28 Nm max. torque

- with LED lighting
- powerful 14.4 V motor
- 2 speed gear train
- idling speed: 0-1400 rpm
- production quality-monitored according to ISO 9001
- ergonomic soft grip for low-fatigue work
- incl. one 14.4 V battery (Li-Ion), 3.0 AH and fast charger with LED display of the charging status
- fast charging possible within 60 minutes
- with detailed operating instructions



① With high-quality lithium ion battery

Description	Speed	Maximum Torque	Part no.
Complete set	1400 U/min	28 Nm	S3200
Replacement battery 14,4 V			S3114-1
Fast charging device 14,4 V			S3114-2

## Cordless Impact Driver



Quick release chuck 6,3 mm (1/4") inner hexagon, 136 Nm max. torque

- with LED lighting
- powerful 14.4 V motor
- idling speed: 0-2300 rpm
- production quality-monitored according to ISO 9001
- long service life thanks to sturdy metal housing for impact head
- ergonomic soft grip for low-fatigue work
- incl. one 14.4 V battery (Li-Ion), 3.0 AH and fast charger with LED display of the charging status
- fast charging possible within 60 minutes
- with detailed operating instructions



① With high-quality lithium ion battery

Description	Part no.
Complete set	S3201
Replacement battery 14,4 V	S3114-1
Fast charging device 14,4 V	S3114-2

## Replacement battery



### Racing Experience

- short charging time - one hour
- with LED status report

① With high-quality lithium ion battery



Description	Part no.
Replacement battery 14,4 V	S3114-1
Replacement battery 19,2 V	S3119-1

## Fast charging device for replacement battery



### Racing Experience

- for Li-Ion batteries
- short charging time – only 1 hour
- with LED charging report



Description	Part no.
Fast charging device 14.4 V	S3114-2

## Battery-operated grease gun



12 Volt - 3-way insert:

- standard grease cartridges + hose + pump / direct filling
- maximum working pressure / load capacity: 420 bar / 6,000 psi
- 750 mm flexible outlet hose with metal protection
- lockable trigger
- battery charge state display
- 12 V / 1.7 Ah NiCd rechargeable battery
- fast charger
- incl. spare battery 12 V
- capacity of the grease cartridge: 400 g
- amount pumped: 80 g/min at 70 bar



① Independent of the power supply, thus ideal for the lubrication of machines and vehicles in mobile use

Description	Part no.
Complete set	64340L
Replacement battery	64340L-1

# Induction Heater

## Easy-Heater



for the fast and precise heating of rusted, seized bolts and nuts or micro-encapsulated connections. Thanks to the inductive pinpoint heating, there is no need to use a welding torch which would lead to other components heating up as well. The additional generator with cooling system guarantees permanent use without unnecessary breaks.

Including 3 heating coils which can be shaped flexible and have a long service life:

- 25 mm at the side
- 20 mm vertical
- "pancake" coil



① The device fulfills the European standards!

Description	Part no.
5-piece	62100L
Lateral Heating Coil out of 62100L	62100L-1
Vertical Heating Coil out of 62100L	62100L-2
Pancake Coil out of 62100L	62100L-3
Flexible Heating Coil for 62100L	62100L-4
Heating Coil for Glow Plugs for 62100L	62100L-5
Heating Coil for Injectors for 62100L	62100L-6



## SAUER Uni-Heat U1230

The unit and the induction head have been designed specifically for removing small dents in the vehicle body. The targeted warming of the vehicle body pushes the dent out of the sheet metal.

### Product benefits:

- Pinpoint heating of components
- No open flames — no heating of/damage to surrounding components
- Particularly suitable for use in tight spaces
- Rapid and easy
- Saves time and increases productivity

### Techn. data:

- Heat output: 1.0 kW
- Current consumption: 10 A
- Power supply: 230 V
- Induction cable: 4.5 m
- Weight: 6 kg



Description
Uni-Heat U1230
Induction head for U1230

Part no.
70100200
70200201

## SAUER Uni-Heat U3230

For a wide range of tasks on vehicle bodies. Ideal for removing adhesive labels, lettering, paint, decorative strips, and insulating mats. The special induction head included also allows removal of glued-in windscreens.

In addition to the basic unit, the scope of delivery also includes the following induction tools:

- Heating pad: For heating entire areas
- Heating rod: For the pinpoint heating of e.g. screws, nuts, tie rods, and exhaust pipes.
- Special head: For removing glued-in car windscreens

### Product benefits:

- Pinpoint heating of components
- No open flames — no heating of/damage to surrounding components
- Particularly suitable for use in tight spaces
- Rapid and easy
- Saves time and increases productivity

### Techn. data:

- Heat output: 3.0 kW
- Current consumption: 16 A
- Power supply: 230 V
- Induction cable: 2.2 m
- Weight: 12.5 kg



Description
Uni-Heat U3230
Heating pad for U3230
Induction head for U3230
Induction rod for U3230
Replacement foot switch for U3230
Replacement glove for U3230

Part no.
70100300
70200301
70200303
70200304
70200305
70200302

## SAUER Maxi-Heat X4230

Professional induction heating unit for heating iron-based materials. The integrated liquid cooling system guarantees high performance even during continuous operation. Induction handle and ferrite core are also available separately.

### Product benefits:

- Pinpoint heating of components
- No open flames — no heating of/damage to surrounding components
- Particularly suitable for use in tight spaces
- Rapid and easy
- Saves time and increases productivity

### Techn. data:

- Heat output: 3.7 kW
- Current consumption: 25 A
- Power supply: 230 V
- Liquid cooling system, 20 ltr.
- Induction cable: 4 m
- Weight: 60 kg



### Description

### Part no.

Maxi-Heat X4230

70100400

Induction handle for X4 and X5 series

70200401

Replacement ferrite core for standard handle

70200402

Vertical induction handle for X4 and X5 series

70200403

Replacement ferrite core for vertical handle

70200404

## SAUER Maxi-Heat X5230

Professional induction heating unit with increased output for more demanding applications. The integrated liquid cooling system guarantees high performance even during continuous operation. Induction handle and ferrite core are also available separately.

### Product benefits:

- Pinpoint heating of components
- No open flames — no heating of/damage to surrounding components
- Particularly suitable for use in tight spaces
- Rapid and easy
- Saves time and increases productivity

### Techn. data:

- Heat output: 5.0 kW
- Current consumption: 28 A
- Power supply: 230 V
- Liquid cooling system, 13 ltr.
- Induction cable: 4 m
- Weight: 70 kg



### Description

### Part no.

Maxi-Heat X5230

70100500

Induction handle for X4 and X5 series

70200401

Replacement ferrite core for standard handle

70200402

Vertical induction handle for X4 and X5 series

70200403

Replacement ferrite core for vertical handle

70200404



## SAUER Maxi-Heat X5380

Professional induction heating unit with increased output for more demanding applications. With 380 volt connector plug. The integrated liquid cooling system guarantees high performance even during continuous operation. Induction handle and ferrite core are also available separately.

### Product benefits:

- Pinpoint heating of components
- No open flames — no heating of/damage to surrounding components
- Particularly suitable for use in tight spaces
- Rapid and easy
- Saves time and increases productivity

### Techn. data:

- Heat output: 5.0 kW
- Current consumption: 28 A
- Power supply: 380 V
- Liquid cooling system, 13 ltr.
- Induction cable: 4 m
- Weight: 85 kg



Description	Part no.
Maxi-Heat X5380	70100600
Induction handle for X4 and X5 series	70200401
Replacement ferrite core for standard handle	70200402
Vertical induction handle for X4 and X5 series	70200403
Replacement ferrite core for vertical handle	70200404

## SAUER Maxi-Heat X11380

Professional induction heating unit for heavy-duty applications. The integrated liquid cooling system guarantees high performance even during continuous operation. Induction handle and ferrite core are also available separately.

### Product benefits:

- Pinpoint heating of components
- No open flames — no heating of/damage to surrounding components
- Particularly suitable for use in tight spaces
- Rapid and easy
- Saves time and increases productivity

### Techn. data:

- Heat output: 11.0 kW
- Current consumption: 16 A
- Power supply: 380 V
- Liquid cooling system: 13 ltr.
- Induction cable: 4 m
- Weight: 107 kg



Description	Part no.
Maxi-Heat X11380	70100700
Standard induction handle for X11380	70200701
Replacement ferrite core for standard handle	70200702
Vertical induction handle for X11380	70200703
Replacement ferrite core for vertical handle	70200704



## SAUER Maxi-Heat X16380



Professional induction heating unit with increased output for heavy-duty applications. The integrated liquid cooling system guarantees high performance even during continuous operation. Induction handle and ferrite core are also available separately.

### Product benefits:

- Pinpoint heating of components
- No open flames — no heating of/damage to surrounding components
- Particularly suitable for use in tight spaces
- Rapid and easy
- Saves time and increases productivity

### Techn. data:

- Heat output: 16.0 kW
- Current consumption: 32 A
- Power supply: 380 V
- Liquid cooling system, 25 ltr.
- Induction cable: 4 m
- Weight: 145 kg



Description	Part no.
Maxi-Heat X16380	70100800
Standard induction handle for X16380	70200801
Replacement ferrite core for standard handle	70200802
Vertical induction handle for X16380	70200803
Replacement ferrite core for vertical handle	70200804

# Battery Charger

## Battery charger



Fully automatic process-controlled charger, especially suitable for motorbike and scooter batteries from 1.2 Ah to 20 Ah. The straightforward charging is carried out via a plug-type charger: Just connect, then charge directly in the socket – that's it!

- Maintenance charge + permanent charge function

### Delivery:

Charge Box 0.8 with adapter cable (pole clamps, lugs, cigarette lighter) and pocket.



Charging current	Battery capacity	Charging voltage	Part no.
0,8 A	1,2 - 20 Ah	12 / 14,4 V	34008L

## Battery charger



Fully automatic process-controlled charger for no less than three different charging modes: motorbike, car and high (AGM + GEL) batteries – only one charger for three battery types! Simple mode change by pressing the "MODE" button. For battery types from 1.2 Ah to 120 Ah. Even batteries that have been completely discharged can be charged again.

- pulse charge + maintenance charge + permanent charging function

### Delivery:

Charge Box 3.6 with adapter cable (pole clamps, lugs, cigarette lighter) and pocket.



Charging current	Battery capacity	Charging voltage	Part no.
0,8 / 3,6 A	1,2 - 120 Ah	12 / 14,4 / 14,7 V	34036L



## Battery charger



Fully automatic process-controlled charger, especially suitable for mobile homes, buses, agricultural machinery, boats and rehabilitation vehicles for capacities from 14 Ah to 230 Ah and from 14 Ah to 120 Ah. The Charge Box 7.0 can be switched from 12 V to 24 V.

- Pulse charge + maintenance charge + permanent charging function

Delivery: Charge Box 7.0 with adapter cable (pole clamps, lugs, cigarette lighter) and pocket.



Charging current	Battery capacity	Charging voltage	Part no.
7 / 5 / 3,5 / 1,5 A	12V 14 bis 230 / 24V 14 bis 120 Ah	14,4 / 14,7 / 28,8 / 29,4 V	34070L

## Adapter cable pole clamps



for connecting to the positive and negative terminal of a battery. The current connection for loading of a battery.



Description	Part no.
Pole clamps	34500L

## Adapter cable lugs



ideal for conservation charging of vintage cars, seasonal cars and motorbikes. It is possible to connect the 6 mm ring cable sockets to the battery permanently.



Description	Part no.
Cable sockets	34510L

## Adapter cable cigarette lighter



ideal for loading the battery via cigarette lighter. Especially useful for car batteries which are difficult to access.



ⓘ Suitable only for cigarette lighter with steady current

Description	Part no.
Cigarette lighter	34520L

## Adapter cable 12V DIN



for loading via 12V connection of BMW motorbikes.



BMW

Description	Part no.
12V DIN	34521L

## Battery charger



Fully automatic processor-controlled charging computer with LCD display. For all 12 and 24 V lead-acid batteries (wet, gel, AGM).

- Mains voltage 120 - 240 V ~ 50 / 60 Hz
- Possible charging current 12V / 24V – 5A or 10A
- Inverse polarity and overheating protection, without sparking
- Digital display of current voltage (Volt = V) and charging current (Ampere = I)
- Ideal for maintenance charge (e.g. during programming or fault queries), permanent charge and pulse charge
- Incl. two permanently connected terminal clamps



### Charging current

12V / 24V - 5A / 10A

### Charging voltage

12 / 24 V

### Part no.

34100L

## Hot Air Blower

### SAUER Plastic Welder PW320



Plastic welding unit for welding cracked or broken plastic parts such as bumpers, inner fenders, plastic coverings etc.

#### Product benefits:

- Hot air also reaches spots around corners
- Pinpoint heating of objects
- Self-sufficient unit
- Stepless temperature adjustment
- Stepless adjustment of air volume

#### Techn. data:

- Heat output: 320 W
- Current consumption: 3.15 A
- Power supply: 230 V
- Air temperature: 150–500°C
- Length of hose package: 1.18 m
- Weight: 3.9 kg



### Part no.

70100900

### Hot air blower

e.g. for removing residual adhesive, heating hoses, paint-stripping work etc. with different attachments

- power 2000 Watts
- stage 1: 350 ° C / 300 l / min.
- stage 2: 550 ° C / 500 l / min.



### Part no.

62005SB

## Hot-Melt Gun

### Hot melt glue gun

with German three wire safety plug and consumables



① including 2 glue sticks with 100 x 11 mm!

Description	Length	Width	Part no.
gun			62010SB
6 glue sticks	100 mm	11 mm	62015SB



# TORQUE TOOLS





# TORQUE TOOLS

## 268-277



▶ Torque Wrenches 270-275

▶ Torque Screwdrivers 275

▶ Torque Angle Gauges 275-276

▶ Torque Multipliers 276





## Torque Wrench

6.3 1/4 YYY

### 6,3 mm (1/4"), 5 – 25 Nm

- calibrated torque with certificate and serial number
- accuracy  $\pm 4\%$
- with switchable ratchet head
- direct numerical display of the desired torque values
- extra fine scale division
- reliable locking of the rotary handle by means of push button
- ergonomically optimized handle
- service-friendly as repair kits are available



Description	Drive	Minimum Torque	Maximum Torque	Part no.
Torque Wrench	6.3	5 Nm	25 Nm	03811L
Repair set for ratchet wrench	6.3			03811L-REP
Spare handle				03819L

## Torque Wrench

10 3/8 YYY

### 10 mm (3/8"), 10 – 50 Nm

- calibrated torque with certificate and serial number
- accuracy  $\pm 4\%$
- with switchable ratchet head
- direct numerical display of the desired torque values
- extra fine scale division
- reliable locking of the rotary handle by means of push button
- ergonomically optimized handle
- service-friendly as repair kits are available



Description	Drive	Minimum Torque	Maximum Torque	Part no.
Torque Wrench	10	10 Nm	50 Nm	03812L
Repair set for ratchet wrench	10			03812L-REP
Spare handle				03819L

## Torque Wrench

12.5 1/2 YYY

- calibrated torque with certificate and serial number
- accuracy  $\pm 4\%$
- with switchable ratchet head
- direct numerical display of the desired torque values
- extra fine scale division
- reliable locking of the rotary handle by means of push button
- ergonomically optimized handle
- service-friendly as repair kits are available



Description	Drive	Minimum Torque	Maximum Torque	Part no.
Torque Wrench	12.5	20 Nm	100 Nm	03813L
Torque Wrench	12.5	40 Nm	200 Nm	03814L
Torque Wrench	12.5	60 Nm	340 Nm	03815L
Repair set for ratchet wrench	12.5			03813L-REP
Repair set for ratchet wrench	12.5			03814L-REP
Repair set for ratchet wrench	12.5			03815L-REP
Spare handle				03819L

## Torque Wrench

20  $\frac{3}{4}$

- calibrated torque with certificate and serial number with switchable ratchet head
- accuracy  $\pm 4\%$
- direct numerical display of the desired torque values
- reliable locking of the rotary handle by means of push button
- extra fine scale division
- ergonomically optimized handle
- service-friendly as repair kits are available



Description	Drive	Minimum Torque	Maximum Torque	Part no.
Torque Wrench		110 Nm	550 Nm	<b>03816L</b>
Torque Wrench		150 Nm	750 Nm	<b>03817L</b>
Repair set for ratchet wrench				<b>03816L-REP</b>
Spare handle				<b>03819L</b>

## Torque Wrench

25  $\frac{1}{2}$

- calibrated torque with certificate and serial number with switchable ratchet head
- accuracy  $\pm 4\%$
- direct numerical display of the desired torque values
- reliable locking of the rotary handle by means of push button
- extra fine scale division
- ergonomically optimized handle
- service-friendly as repair kits are available



Description	Drive	Minimum Torque	Maximum Torque	Part no.
Torque Wrench		200 Nm	1000 Nm	<b>03818L</b>
Repair set for ratchet wrench				<b>03818L-REP</b>
Spare handle				<b>03819L</b>

## Torque Wrench

6.3  $\frac{1}{8}$

- calibrated torque wrench with certificate and serial number
- left and right-handed
- with switchable ratchet head
- double scale Ft-LB
- extra-fine scale division
- secure locking of the rotary handle
- service-friendly as repair kits are available



Description	Drive	Minimum Torque	Maximum Torque	Part no.
Torque Wrench		2 Nm	10 Nm	<b>03810L</b>
Torque Wrench		5 Nm	25 Nm	<b>03809L</b>
Repair set for ratchet wrench				<b>03810L-REP</b>





## Torque Wrench



- calibrated torque wrench with certificate and serial number
- left and right-handed
- with switchable ratchet head
- double scale Ft-LB
- extra-fine scale division
- secure locking of the rotary handle
- service-friendly as repair kits are available



Drive	Minimum Torque	Maximum Torque	Part no.
	20 Nm	100 Nm	<b>03808L</b>
	40 Nm	200 Nm	<b>03807L</b>
	60 Nm	340 Nm	<b>03821L</b>

## Torque Wrench



- calibrated torque wrench with certificate and serial number
- for clockwise and anti-clockwise tightening
- with changeable ratchet head
- double scale Ft-LB
- extra-fine dial division
- secure interlocking of the turn grip
- service friendly, since repair sets are available

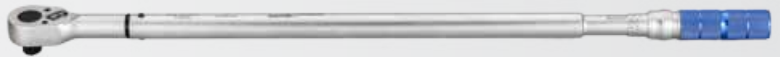

Drive	Minimum Torque	Maximum Torque	Part no.
	110 Nm	550 Nm	<b>03822L</b>

## Torque Wrench



- Socket connector for insert tools, 14x18 mm
- The head is replaced in seconds
- Calibrated torque wrench with calibration certificate and series number
- Direct numerical display of the selected torque value
- Secure locking of the rotating handle by push button
- Ideal ergonomic handle form
- Repair set is available as a welcome service feature
- Wide programme of optionally available insert tools



Minimum Torque	Maximum Torque	Part no.
40 Nm	200 Nm	<b>03830L</b>

## Reversible ratchet insert



Socket 14 x 18 mm



Drive	Part no.
	<b>03831L</b>

## Square drive insert



Socket 14 x 18 mm



Drive	Part no.
	<b>03832L</b>



## Open-ended spanner insert



Socket 14 x 18 mm



Description	Part no.
Open-ended spanner - wrench size 13	03833L
Open-ended spanner - wrench size 14	03834L
Open-ended spanner - wrench size 15	03835L
Open-ended spanner - wrench size 16	03836L
Open-ended spanner - wrench size 17	03837L
Open-ended spanner - wrench size 18	03838L
Open-ended spanner - wrench size 19	03839L
Open-ended spanner - wrench size 21	03841L
Open-ended spanner - wrench size 22	03842L
Open-ended spanner - wrench size 24	03844L
Open-ended spanner - wrench size 27	03847L

## Ring wrench insert



Socket 14 x 18 mm



Description	Part no.
Ring wrench insert - wrench size 13	03853L
Ring wrench insert - wrench size 14	03854L
Ring wrench insert - wrench size 15	03855L
Ring wrench insert - wrench size 16	03856L
Ring wrench insert - wrench size 17	03857L
Ring wrench insert - wrench size 18	03858L
Ring wrench insert - wrench size 19	03859L
Ring wrench insert - wrench size 21	03861L
Ring wrench insert - wrench size 22	03862L
Ring wrench insert - wrench size 24	03864L
Ring wrench insert - wrench size 27	03867L

## Torque wrench



electronic, right/left triggering and switching, acoustic triggering, measuring range 20 - 200 Nm, easy to set with precise description of use.  
The wrench does not have to be reset after use, since the electronics prevent spring wear.

- with serial number and calibration certificate
- 9V battery included



① **New improved version**

Drive	Minimum Torque	Maximum Torque	Part no.
	20 Nm	200 Nm	03935L





## Digital torque adapter



transforms every ratchet into a torque wrench

- Precision +/- 2%
- For right and left-hand tightening
- acoustic / optical signal when reaching the preset torque



Description	Drive	Minimum Torque	Maximum Torque	Part no.
12,5 mm (1/2") drive		40 Nm	200 Nm	<b>03928L</b>

## Torque wrench



switchable, set value can be locked, in plastic box



**With certificate**

Description	Drive	Minimum Torque	Maximum Torque	Part no.
Torque wrench		19 Nm	110 Nm	<b>03905L</b>
Torque wrench		40 Nm	210 Nm	<b>03933L</b>
Repair set 1/2"				<b>03933L-REP</b>



## Torque wrench



with 12.5 mm (1/2") drive  
the torque set is fixed by a locking screw



Drive	Minimum Torque	Maximum Torque	Part no.
	30 Nm	210 Nm	<b>03900L</b>

## Torque wrench



in case, the torque set is fixed by a locking screw, the scope of delivery includes a 125 mm extension as well as a reducing adapter to 10 mm (3/8") drive



Drive	Minimum Torque	Maximum Torque	Part no.
	28 Nm	210 Nm	<b>03902L</b>

## Torque wrench



switchable, set value can be locked, in plastic box



Drive	Minimum Torque	Maximum Torque	Part no.
	5 Nm	25 Nm	<b>03920L</b>
	5 Nm	25 Nm	<b>03921L</b>

## Torque wrench



switchable, set value can be locked



Description	Drive	Minimum Torque	Maximum Torque	Part no.
Torque wrench		100 Nm	500 Nm	03940L-IMP
Torque wrench		140 Nm	700 Nm	03941L-IMP
Torque wrench		140 Nm	980 Nm	03942L-IMP
Repair set for ratchet 3/4"				03942L-REP



## Torque Screwdrivers

### Torque screwdriver



with outer square drive, torque can be locked at 1 - 5 Nm inc. 1/4" bit adapter



Drive	Minimum Torque	Maximum Torque	Part no.
	1 Nm	5 Nm	03903L

### Torque screwdriver



default setting at 1.4 Nm with 6.3 mm (1/4") hex bit adapter



Drive	Output	Torque	Part no.
	6,3 mm (1/4") hexagonal	1,4 Nm	03907L

### Torque screwdriver



default setting at 1.4 Nm with 6.3 mm (1/4") hex socket for interchangeable torque blades.

Dual-component torque screwdriver with set torque (tolerance  $\pm 6\%$ ).



Description	Drive	Torque	Part no.
Handle		1,4 Nm	03904L
Replacement blade			03904L-1

## Torque Angle Gauges

### Rotary angle measuring disc



for use on 12.5 mm (1/2") torque wrenches, simple measuring instrument with additional fixing



Drive	Part no.
	03910L



## Rotary angle measuring device

for use on 12.5 mm (1/2") torque wrenches, can be fixed in place using a clamping screw



Drive

Part no.



03915L

## Rotary angle measuring device

for use on 12.5 mm (1/2") drive tools with maximum measuring precision, enables tightening of the specified angle e.g. for cheese-head screws in one operation, max. load capacity approx. 280 Nm full-metal version with magnetic foot for fixing



Drive

Part no.



03916L

# Torque Multipliers

## Torque reproducer



Reproducer and truck wheel bolt service set, 25 mm (1") input and output with extension, crank and inserts 24, 27, 30, 32, 33, 36, 38 mm, transferrable torque: 3200 Nm

CAUTION: Only use for loosening purposes. The extreme 56-fold gear ratio will otherwise lead to damage to screws, threads and nuts  
Even extremely tight or rusty wheel bolts can be loosened easily, then the bolt is either removed quickly or refitted using the extension and crank.



Description

Drive

Part no.

10-piece,  
24, 27, 30, 32, 33, 36, 38 mm  
5-piece,  
32, 33 mm



03965L



03966L

## Torque reproducer



truck wheel bolt service set with integrated torque wrench. Facilitates the loosening of wheel bolts with up to 1.400 Nm as well as the tightening with up to 650 Nm. Therefore it is an ideal tool for service operations.

As a counter-piece is included, the torque reproducer is also suitable for installation and removal of wheel bolts on wheels with wheel cap. Please be advised that you need to order suitable impact spanner sockets separately.



ⓘ Please check the tightening torque immediately after wheel change!

Description

Drive

Part no.

4-piece



03955L



# DIAGNOSIS AND TESTING UNITS





# DIAGNOSIS & TESTING UNITS 278-287



▶ OBD-Diagnostic	280
▶ Engine Compression Test	280-281
▶ Diesel Injection Test	282
▶ Fuel Pressure Test	283
▶ Oil Pressure Test	284
▶ Coolant Test	284-286
▶ Ignition Test	286
▶ Noise Diagnostic	286-287





## Fault code reader

for reading out and deleting the engine fault memory via OBDII plug. General (P0, P2, P3 and U0) and vehicle-dependent (P1, P3, U1) codes are recognised for the brands Audi, Alfa Romeo, BMW, Chrysler, Citroën, Daewoo, Daihatsu, Fiat, Ford, Honda, Hyundai, Iveco, Jaguar, KIA, Lexus, MAN, Mazda, Mercedes-Benz, Mitsubishi, Nissan, Opel, Peugeot, Porsche, Renault, Saab, Scania, Škoda, Subaru, Suzuki, Toyota, VW, Volvo

- Suitable for vehicles with OBDII / EOBD Petrol engines from '00, diesel from '03

Protocols supported:

CAN, ISO9141, KW2000, VPW, PWM  
Many other functions, e.g.

- Reading and deleting the DCTs of the control units- Deleting the status of the engine warning lamp
- Inquiry of the VIN on vehicles manufactured since '02 (mode 9 supported)
- Status inquiry for sensors with engine running
- Language settings English, French, German, Dutch, Spanish
- Date storage and printing (printing in conjunction with USB cable and external computer)
- In a practical nylon bag



Alfa Romeo  
Audi  
BMW  
Chrysler  
Citroën  
Daewoo  
Daihatsu  
Fiat  
Ford  
Honda  
Hyundai  
Iveco  
Jaguar  
Kia  
Lexus  
MAN  
Mazda  
Mercedes-Benz  
Mitsubishi  
Nissan  
Opel  
Peugeot  
Porsche  
Renault  
Saab  
Scania LKW  
Škoda  
Subaru  
Suzuki  
Toyota  
Volvo  
VW  
Seat

- ⓘ Incl. operating manual and software CD in English, additional battery not included!  
Does not delete any safety-related and currently pending faults.

Part no.  
**32291L**

## Engine Compression Test

### Compression tester

The compression tester is used in place of the spark plug or injection nozzle for the straightforward testing of whether pistons, piston rings or cylinder heads are faulty. After the engine has turned over several times through the starter, the cylinder compression can be read off on the tester.

For diesel engines, inc. quick-action couplings for fast work. Integrated resetting device for repeated measurement without dismantling being necessary.

- flexible hose ca. 355 mm long
- scale 0 - 70 bar / 0 - 1000 psi
- 6 spark plug adapters
- 2 x M10 (68 mm), 1 x M10 (54 mm), 3 x M12 (44 mm)
- 2 injection valve adapters
- 2 diesel pre-heating adapters
- 1 angled adapter 90°
- 5 connection adapters for coupling



Engine type  
Diesel

Part no.  
**26071L**



## Compression and pressure loss tester

for petrol & diesel engines.

For professionally testing compression and pressure loss in most car, truck, motor cycle, bus, agricultural vehicle and boat engines as well as in Hdi / TDCi and pump nozzle engines. Contains a glow plug adapter for the following manufacturers e.g.: Alfa, BMW, Chrysler, Daewoo, Fiat, Ford, Hyundai, Isuzu, Land Rover, Mazda, Mercedes-Benz, Mitsubishi, Nissan, Opel, PSA, Renault, Saab, Suzuki, Toyota, VAG, Vauxhall, Volvo, etc.

- glow plug adapters M10, M12, M14 and M18
- compression pressure tester, max. 50 bar
- quick-action couplings (straight and angular versions)
- injection nozzle adapters M20, M22, M24 and for Ford Stana-dyne injectors



- Alfa Romeo
- BMW
- Chrysler
- Daewoo
- Fiat
- Ford
- Hyundai
- Isuzu
- Land Rover
- Mazda
- Mercedes-Benz
- Mitsubishi
- Nissan
- Opel
- Renault
- Saab
- Suzuki
- Toyota
- Vauxhall
- Volvo



Description	Engine type	Part no.
48-piece	Petrol / Diesel	26119L

## Pressure loss tester

for testing the leakproofness of individual cylinders on diesel and petrol engines

- Gauge
- adapter M12 x 1.25 mm for motorcycles
- adapter M10 x 1.00 mm for motorcycles
- adapter M24 x 2 mm for diesel engines
- adapter M12 x 1.25 mm with 7 mm hole for VW diesel engines
- adapter for multivalve engines
- adapter for M14 x 1.25 and M18 x 1.5 mm



Description	Engine type	Part no.
7-piece	Universal	26046L
Gauge	Universal	26046L-T
Adapter M12 x 1,25 mm for Motorcycles	Universal	26046L-01
Adapter M10 x 1,00 mm for Motorcycles	Universal	26046L-02
Adapter M24 x 2 mm for diesel engines	Diesel	26046L-03
Adapter M12 x 1,25 mm with 7 mm hole for VW diesel engines	Diesel	26046L-04
Adapter M14 x 1,25 mm for Mehrventilmotoren	Universal	26046L-05
Adapter for M14x1,25 and M18x1,5 mm	Universal	26046L-C

## Compression tester

with bleeding valve, adapter connection through quick-action coupling

- inc. 14 mm and 18 mm adapters
- Measuring range 0 - 21 bar
- 300 mm hose length

ⓘ Before starting, break the power supply of the spark coil with the engine fuel supply!



Description	Engine type	Part no.
M14 and M18 incl. M14 Adapterextension 40 mm	Petrol	26074L
M14 connection with reduction to 10 mm	Petrol	26115L



## Return quantity tester



For diagnosing faults by measuring return quantities to the injector in common rail engines. Measurement takes place simultaneously at up to 6 injection nozzles. This is either through plastic bulbs that can be connected directly or through the hoses and measuring cups. The adapters fit all systems e.g Siemens, Bosch, Denso, Delphi etc.

- 6 measuring cups with 700 mm connection hose each mounted on aluminium strip with hook
- 6 plastic bulbs for direct measurement
- Suitable for different injector manufacturers



ⓘ Incl. adapter set

Description	Part no.
31-piece	26110L

## Injector quantity tester



For diagnosing faults by measuring return quantities to the injector in common rail engines. Measurement takes place simultaneously at up to 6 injection nozzles. This is either through plastic bulbs that can be connected directly or through the hoses and measuring cups.

- measuring cups with 700 mm connection hose each
- mounted on aluminium strip with hook
- 6 plastic bulbs for direct measurement
- suitable for different injector manufacturers



Nissan  
Mercedes-Benz  
Ford  
Citroën  
BMW  
Opel  
Peugeot  
Renault  
Toyota  
Vauxhall  
Volvo

Description	Part no.
Injector quantity tester	26078L
Plastic bulb with adapter out of 26078L	26078L-1
Measuring cup out of 26078L	26078L-2

## Injector adapter set



- as supplement to injector quantity tester 26078L
- the adapters fit all systems e.g Siemens, Bosch, Denso etc
- packed in an assorted box



Part no.  
26079L

## Tester for diesel injector sockets



for precise adjustment of injection pressure and for checking the injection nozzles:

- blocked nozzles
- shape of injection spray
- leakiness of nozzles

Including:

- 2 adapters M12 x 1.5 and M14 x 1.5
- container with microfilter
- with supporting foot four mounting on the bench



Description	Part no.
Pressure gauge up to 600 bar	26091L
Replacement tank	26091L-1

## Petrol pressure tester

70-piece with manometer.

Ideal for mechanical and electronic petrol injection systems. Suitable for all standard vehicle manufacturers, e.g. Mercedes, BMW, VW, Audi, Opel, Ford, Honda, Mazda, Renault, Peugeot etc. with the following injection systems: K-Jetronic, L/LH-Jetronic, Motronic, Motronic-Jetronic, MPFI, TBI, EFI, DIGIFANT 1/2, CIS-Digital, Weber CFI, Spi, Single Point / Multipoint from Bosch, Lucas, etc. Straightforward testing for leaks, as well as system and control pressure through adjustable 3-way valve.

- Precision manometer 0.03 - 8 bar (0.5 - 120 psi)
- 5 hoses, coupling on both sides
- 30 adapters for European, Asian and American vehicles



Audi  
BMW  
Mazda  
Mercedes-Benz  
Peugeot  
Renault  
Seat  
Škoda  
VW  
Ford



Engine type

Petrol

Part no.

26073L

## Synchronous carburettor tester



For synchronous measurement of 2 - 4 carburettors

- 4 manometers, mounted on board
- 4 rubber hoses 8 x 5 x 750 mm
- 4 hose clamps + replacement sealing rings
- 4 connectors 53 mm (M6x0.75)
- 4 connectors 60 mm (M6x1.00)
- 4 extensions 3.9 x 52 mm
- 4 extensions 3.9 x 122 mm

Suitable for motorbikes and passenger cars.



Engine type

Petrol

Part no.

26093L

# Oil Pressure Test



## Oil pressure tester



for measuring the current oil pressure.

- scale 0 - 10 Bar
- 2.0m tube length
- Can be used universally

With the following connection adapters:

- R 1/8" DIN 2999
- 1/8" x 27 NPT
- 1/4" x 18 NPT - 3/8" x 20 UNF - 1/2" x 20 UNF
- M10 x 1,0 - M12 x 1,5 - M14 x 1,5 - M16 x 1,5 - M18 x 1,5 - 90°

- Audi
- Alfa Romeo
- Austin Rover
- BMW
- Citroën
- Daihatsu
- Fiat
- Ford
- Honda
- Hyundai
- Suzuki
- Jaguar
- Lada
- Lancia
- Land Rover
- MAN
- MAN LKW
- Mazda
- Mercedes-Benz
- Mercedes-Benz LKW
- Mitsubishi
- Mitsubishi LKW
- Nissan
- Opel
- Peugeot
- Renault
- Renault LKW
- Rover
- Saab
- Seat
- Škoda
- Subaru
- Suzuki
- Toyota
- Volvo
- VW



ⓘ Shows the current oil pressure.

Engine type  
Universal

Part no.  
26166L

# Coolant Test

## Digital infrared thermometer



With laser pointer, automatic shutdown, illuminated digital display, ideal for measurements on hot or rotating parts, liquids or spots that are difficult to reach.

- measuring range -50 to + 550°C
- measuring accuracy ± 2.5%
- operating temperature: 0° - 50°C
- distance factor 12 : 1
- switchable °F / °C
- incl. 2x AAA battery



Part no.  
72360L

## CO<sub>2</sub> leak detector



For all water-cooled combustion engines, to be used in combination with our radiator removal tool 21000L / 21030L. Indicates the occurrence of CO<sub>2</sub> exactly in the cooling system. The CO<sub>2</sub> gases cause the testing fluid to change colour from blue to yellow.

This process can be reversed by adding outer air.



① Suitable for petrol-, diesel-, and gas vehicles

Description	Part no.
5-piece	<b>21050L</b>
Testing fluid 300 ml	<b>21051L</b>
Flushing liquid	<b>21052L</b>

## Coolant system testing and filling device



for the straightforward bubble-free filling of coolant systems, at the same time testing for leaks.

- universal version with quick-action coupling
- including flexible hose for working on connections that are difficult to access
- manometer with rubber protection
- with valve for pressure relief



Description	Part no.
6-piece	<b>21010L</b>

## Antifreeze tester



with float



Part no.  
**21500L**

## Antifreeze and coolant tester



suitable for all ethylene and glycol solutions, also allows optical checks for rust and other impurities

- for ethylene
- for glycol
- for hot and cold liquid



Part no.  
**21505L**



## Refractometer

for testing battery acid density from 1.1 - 1.4 kg/l and antifreeze coolant from 0° / -50 °C as well as windscreen washing fluid from 0° / -40 °C

- adjustable ocular
- settable calibration fixture
- measuring accuracy +/- 5%

Used as VAG OEM T10007 A

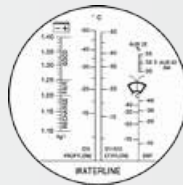

ⓘ Also suitable for checking the correct mixing ratios for AdBlue® (AUS 32) additives and windshield cleaner based on alcohol (SRF1) and ethanol.

Description	Part no.
Complete in case	21550L
Replacement glass	21550L-1
Pipette	21550L-2

## Ignition Test

### Digital ignition timing gun

(stroboscope) for 12 Volt systems in 2, 3, 4, 5, 6, 8-cylinder engines. Can be used for 4-stroke distributor ignition systems, 2-stroke and twin-spark ignition systems.

With xenon lamp, red and black cable clamps for the power supply, inductive clamp and green crocodile clip for measuring speed, closing angle and for the voltage test.

- perfect setting of ignition from 0 to 60°
- closing angle test from 0 – 99.9% with conversion table
- engine speed counter from 200 – 9999 rpm
- voltage drop test
- voltmeter



Part no.  
32229L

### Diesel special tool set

for testing and setting the engine control and start of delivery on injection pumps. Setting values and operating instructions included.

- Suitable for Bosch EP/VE, Rotary, Kikki, Nippon, Lucas, CAV, Roto
- Depth gauge 0 - 5 mm

ⓘ Including pivoted gauge holder



Citroën  
Fiat  
Opel  
Peugeot  
Renault  
Rover  
VW  
Volvo  
Audi

Description	Part no.
Complete set	26060L

## Noise Diagnostic

### Universal stethoscope

with steel tip, for localising creaking and squeaking sounds on the body as well as for detecting mechanical damage on

- engine
- gearbox
- differential



Part no.  
405130L

## Electronic stethoscope



for tracing:

- Mechanical damage to engine, gearbox, differential
- Noises such as creaking and squeaking on the body
- Volume infinitely adjustable
- 9 V battery included



Part no.  
**S3532**



## Electronic stethoscope



for tracing mechanical damage to engines, gearboxes, differential - noises such as creaking and squeaking on the bodywork

- volume infinitely adjustable
- complete in carrying case
- incl. 2 x 9V batteries
- can be used as an engine stethoscope with flexible shaft and highly sensitive microphone
- additional use with 6-channel distributor and 6 sensors with 4.8 m connection cable in order to track down sources of noise on components – even during driving!



Description  
21-piece

Part no.  
**S3531**



# ENGINE







# ENGINE

**288-409**



- ▶ Removing and Installing Engine 290-294
- ▶ Diesel Injection 294-305
- ▶ Glow Plugs 305-313
- ▶ Ignition 313-319
- ▶ V-Belt / Tensioner 320-326
- ▶ Camshaft / Timing Belt / Chain 326-356
- ▶ Cylinder Head / Valves 356-362
- ▶ Engine Block / Piston 362-365
- ▶ Engine Rubber Bearing 366
- ▶ Fuel System 366-380
- ▶ Coolant System 381-392
- ▶ Lubricant System 393-406
- ▶ Turbo Charger 407-408





## Engine stand

Rotatable through 360° and lockable in 8 positions

- Casters with ball bearings
- The angle of the 4 attachment points and the distance between them can be adjusted
- The support plate can be turned so that the engine can be turned



Description	Rated load capacity	Part no.
Standard version	450 kg	20301L
XL version	570 kg	20302L

## Workshop crane



Multi-purpose workshop crane for weights of up to 1000 kg. The crane arm is adjustable in length and has a chain with safety hook. The 2 moving casters ensure maximum flexibility even under load. Space-saving storage thanks to fold-away supports.

Technical data:

- max. lifting capacity: 250 - 1000 kg
- max. lifting arm length: 902 - 1169 mm
- max. lifting height: 2019 - 2248 mm
- lifting cylinder with safety valve
- can be folded away for space-saving storage and transport, can be completely dismantled if necessary
- 2 casters, 2 fixed wheels made of steel
- including chain with safety hook

Dimensions when folded (LxWxH) 600 x 790 x 1560 mm  
Height of the frame 160 mm  
Base frame (LxW) 1570 x 850 mm



### Rated load capacity

1000 kg

### Part no.

20310L

## Engine alignment support bar



for the precise positioning of the engine during fitting and removal. Makes it easier to attach the engine to the gearbox by balancing out the centre of gravity.

- load-bearing capacity 350 kg
- Inner dimension 490 mm
- adjustment dimension +/- 210 mm
- two chains à 500 mm
- crank 160 mm



### Rated load capacity

350 kg

### Part no.

20315L

## Engine bridge



For safe work on belts, gearboxes, etc.

- Made of stable square tubing
- For flexible widths
- Holding hooks with 16 mm threaded rods
- With rubber padding to protect the mudguards
- Chain length 900 mm
- Assembly dimensions 1010 mm to 1520 mm



### Rated load capacity

1 chain, 300 kg

### Part no.

20303L

## Engine bridge



for assembling and disassembling the engine and gears

- made from a stable four edged pipe
- long hole (700 mm ) for flexible width setting
- holding hook with a 20 mm threaded rod
- with rubber protectors to protect the mudguard
- chain length 900 mm
- mountable from 750 - 1.450 mm



### Rated load capacity

2 chains, 500 kg

### Part no.

20305L

## Engine bridge



to support the engine when removing the gearbox. Suitable for

- VW T5

Used like:

- VW OE no. 10-222A/23 support arms

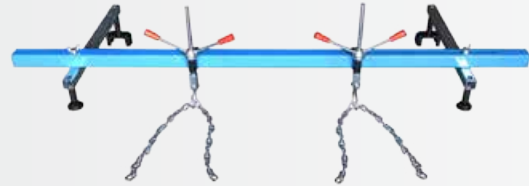

VW

### Part no.

20304L

## Engine support bar



- Variable length from 630 to 960 mm

It is not possible to use typical engine bridges on many new vehicles, as the mudguards fall away at a slant or are made of plastic. The universal engine support bar provides the engine with secure support from below.



### Part no.

26596L

## Engine support crossmember

The universal engine support tie-bar securely holds the engine from below as soon as the side engine bearings are dismantled. The usual engine bridge is no longer required. When working on the toothed belt, water pump or auxiliary drive, a free access from above is now possible.

- the two adjustable mounting hooks securely hold the motor support beam at the vehicle floor.
- height-adjustable support plate for targeted lowering or lifting of the motor.
- the rear support arms can be positioned independently of each other by means of a hinge. Wide long holes in the arms help to find the best position for the support.
- incl. A receptacle for standard transmission drives. This means that the beam can also be installed very simply by one person.

Features:

- maximum support load: 250 kg
- variable length from 374 mm to 1,170 mm
- telescopic arm: 230 mm extendable
- support arms: pivoting 360° rotatable, 122 mm long holes

⚠ Do not use with pneumatic impact wrenches!



### Rated load capacity

250 kg

### Part no.

26597L





## Engine support bar



for fast and professional mounting and removal of the engine suspension when working on tensioning roller, toothed belt and water pump.  
No cumbersome and time-consuming mounting of engine bridges that cannot be used any on many vehicles for structural reasons.  
The large number of adapters for the basic unit allows work to be carried out on almost all current vehicles.

- Comparable tools at Ford OEM 303-1554

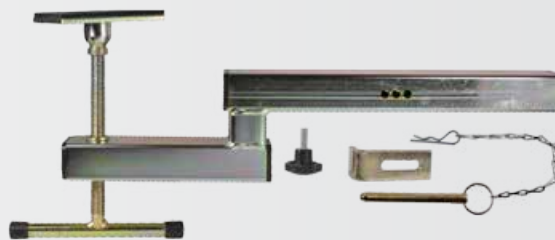

Description	Part no.
Basic unit with clip, screw, chain	26510L

## Engine support bar



for use with basic unit 26510L

Seat  
VW



Description	Part no.
Support bar for VW Sharan, Galaxy, Seat Alhambra	26520L
Support bar for VW Golf IV, New Beetle, Audi A3, Škoda Octavia, Seat Leon, Toledo	26521L
Support bar for VW Golf V, Touran, Audi A3 from '04, Seat Altea, Toledo, Škoda Octavia from '04, Seat Leon from '05	26522L
Support bar for VW Lupo 3l	26523L
Support bar for VW Polo, Škoda Fabia, Seat Ibiza from '02	26524L
Support bar for VW Lupo 4-cylinder, VW Fox	26526L
Support bar for VW Passat 2.0	26527L
Adapter Škoda Octavia 2.0tdi ab '07	26528L
VW Passat 3C 2.0TDI ab 08/05, Tiguan ab '07	26528L
Support bar for VW Up, Seat Mii, Škoda Citigo since '12	26557L
Support bar for VW Golf VII, Seat Leon, Škoda Octavia, Audi A3 ('12)	26558L
Support bar for VW T5, Sharan II, Passat, Seat Alhambra ('10)	26559L

## Engine support bar



for use with basic unit 26510L

Opel



Description	Part no.
Support bar for Opel Zafira B (petrol) from 2005	26560L
Support bar for Opel Vectra C (diesel) from '05	26561L
Support bar for Opel Vectra C 1.6 - 1.8l (petrol) from '02	26562L
Support bar for Opel Vivaro	26564L
Support bar for Opel Zafira A (petrol), Astra 1.6l (petrol) from '99	26563L
Adapter Opel Corsa D Benzin u. Diesel	26565L

## Engine support bar



for use with basic unit 26510L

Ford



ⓘ Suitable for gear box operations with extension 26505L

Description	Part no.
Support bar for Ford Focus from '98 without C-Max	26530L
Support bar for Ford Focus C-Max from '03, Volvo S50 / V50	26531L
Support bar for Ford Fusion, Fiesta	26532L
Support bar for Ford Fiesta diesel from '05	26533L
Support bar for Ford S-Max from '06	26534L
Adapter timing belt + gear box Ford Fiesta from '09	26535L
Adapter Ford Ka / Fiat 500, Panda 1200 from '04	26536L
Adapter Ford form '10	26537L

## Engine support bar

for use with basic unit 26510L



Peugeot  
Citroën



① Suitable for gear box operations with extension 26505L

Description	Part no.
Support bar for Peugeot 806, Citroën Jumpy	26543L
Support bar for Peugeot 206 + 307	26540L
Support bar for Peugeot 406, Partner, Citroën Berlingo	26541L
Support bar for Peugeot 407	26542L
Support bar for Peugeot 807, Citroën C8	26544L
Support bar for Peugeot 607	26545L
Support bar for Peugeot Boxer, Citroën Jumper, Fiat Ducato	26546L
Support bar for Peugeot Boxer from '07	26547L
Support bar for Peugeot 308 2.6l Benzin	26548L
Support bar for Peugeot 207 1.6l HDI / 1007 1.4l Diesel	26549L
Support bar for Citroën C4	26550L
Support bar for Citroën C5	26551L
Support bar for Citroën Picasso, Xantia, Xsara, ZX	26552L
Support bar for Citroën C2, C3 1.4l	26553L
Support bar for timing belt + gear box Citroën C1, Peugeot 107, Toyota Aygo	26554L
Support bar for Citroën DS5 from '12	26555L
Support bar for Citroën C5 from '11	26556L

## Engine support bar

for use with basic unit 26510L



Renault



Description	Part no.
Support bar for Renault Mégane I	26513L
Support bar for Renault Mégane II	26516L
Support bar for Renault Kangoo 1.4, Clio II, 1.2 from 2004	26512L
Support bar for Renault Espace III	26511L
Support bar for Renault Laguna 1.8	26514L
Support bar for Renault Scenic II	26515L

## Engine support bar

for use with basic unit 26510L



Hyundai



Description	Part no.
Support bar for Hyundai I10 from '12	26566L
Support bar for Hyundai I20 from '10	26567L
Support bar for Hyundai I30 from '12	26568L
Support bar for Hyundai I40 from '12	26569L

## Engine support bar

for use with basic unit 26510L



Fiat



Description	Part no.
Support bar for Fiat Punto from '06, Mito	26570L
Support bar for Fiat Stilo 1.6 (petrol)	26571L
Support bar for Fiat Doblo	26572L
Support bar for Fiat Punto 1998 - 2005	26573L
Support bar for Fiat Multipla	26574L
Support bar for Fiat Doblo (diesel)	26575L
Support bar for Alfa 159 (diesel) from 2006	26580L

# Removing and Installing Engine



## Engine support bar

for use with basic unit 26510L



Suzuki



**Description**  
Support bar for Suzuki Swift

**Part no.**  
26590L

## Adjusting bolts set

for the exactly aligned fitting of the sub-frame.

Is required e.g. for replacement of rubber bushings as well as all work involving the removal of the sub-frame.

- VW Scirocco ('09), EOS ('06), Golf ('09), Golf Plus ('05), Jetta ('04-'06), Polo ('02), Fox ('06), Passat ('06), Passat CL ('09)
- Audi A3 ('04), TT ('07), A4 ('01)
- to be used like OEM T10096



VW  
Audi

**Description**  
4-piece

**Part no.**  
26504L

## Adjusting bolts set

for the exactly aligned fitting of the sub-frame.

Is required e.g. for replacement of rubber bushings as well as all work involving the removal of the sub-frame.

- VW T5 since ('04)
- size: M14 x 1.5
- to be used like OE T10227



VW

**Description**  
4-piece

**Part no.**  
26506L

# Diesel Injection

## Special spanner socket, Double hexagon, Extra long

extra deep version for injection nozzles



**Profile**  
S 1

**Length**  
27 mm

**Part no.**  
26031L

## Diesel special tool set

for testing and setting the engine control and start of delivery on injection pumps.  
Setting values and operating instructions included.

- Suitable for Bosch EP/VE, Rotary, Kikki, Nippon, Lucas, CAV, Roto
- Depth gauge 0 - 5 mm

ⓘ Including pivoted gauge holder



Citroën  
Fiat  
Opel  
Peugeot  
Renault  
Rover  
VW  
Volvo  
Audi

**Description**  
Complete set

**Part no.**  
26060L

## Return quantity tester

For diagnosing faults by measuring return quantities to the injector in common rail engines. Measurement takes place simultaneously at up to 6 injection nozzles. This is either through plastic bulbs that can be connected directly or through the hoses and measuring cups.

The adapters fit all systems e.g Siemens, Bosch, Denso, Delphi etc.

- 6 measuring cups with 700 mm connection hose each mounted on aluminium strip with hook
- 6 plastic bulbs for direct measurement
- Suitable for different injector manufacturers

① Incl. adapter set



## Injector quantity tester

For diagnosing faults by measuring return quantities to the injector in common rail engines. Measurement takes place simultaneously at up to 6 injection nozzles. This is either through plastic bulbs that can be connected directly or through the hoses and measuring cups.

- measuring cups with 700 mm connection hose each
- mounted on aluminium strip with hook
- 6 plastic bulbs for direct measurement
- suitable for different injector manufacturers



Nissan  
Mercedes-Benz  
Ford  
Citroën  
BMW  
Opel  
Peugeot  
Renault  
Toyota  
Vauxhall  
Volvo

Description	Part no.
Injector quantity tester	26078L
Plastic bulb with adapter out of 26078L	26078L-1
Measuring cup out of 26078L	26078L-2

## Injector adapter set

- as supplement to injector quantity tester 26078L
- the adapters fit all systems e.g Siemens, Bosch, Denso etc
- packed in an assorted box



Part no.

26079L

## Tester for diesel injector sockets

for precise adjustment of injection pressure and for checking the injection nozzles:

blocked nozzles

- shape of injection spray
- leakiness of nozzles

Including:

- 2 adapters M12 x 1.5 and M14 x 1.5
- container with microfilter
- with supporting foot four mounting on the bench



Description	Part no.
Pressure gauge up to 600 bar	26091L
Replacement tank	26091L-1



## Injector / injector nozzle extraction tool set

for Bosch, Denso, Siemens, Delphi and Piezo nozzles. For hydraulic or mechanical use without cylinder head dismantling - directly at the car. The variable shape of the extraction bridge allows a safe and precise extraction, particularly of very tightly fitting injectors. Contrary to hammer solutions the injectors are extracted evenly and in an optimum angle. Wide range of accessories for special applications.

- compact 17 t hydraulic cylinder
- mechanical pull-off tool
- variable bridge with several adapters to support on the cylinder head
- hexagon screwdriver bit for PSA (HDI) and Mercedes-Benz (CDI)
- groove nut bit with three lugs for Denso
- groove nut bit with four lugs for Siemens
- special tension bolts and retaining nuts for Bosch, Denso, Delphi and Siemens injectors

e.g. for Alfa, BMW, Fiat, Ford, Hyundai, Iveco, Kia, Mazda, Mercedes-Benz, Opel, PSA, Renault, Suzuki, Toyota, Volvo



Ford  
Fiat  
BMW  
Alfa Romeo  
Hyundai  
Iveco  
Kia  
Mazda  
Mercedes-Benz  
Opel  
Renault  
Suzuki  
Toyota  
Volvo

ⓘ The 17 to. hydraulic cylinder can be actuated using the foot pump 301120L. Can be used immediately without additional hose coupler!

Description  
46-piece

Part no.  
26120L

## Injector extraction tool set

Universal extraction tool for injectors by Delphi, Toyota, Siemens and Bosch. Particularly suited to jammed injectors.

Including a 12-tonne hydraulic cylinder with 3/8" NPT F connector.

Adapters for the following injector sizes are included in the set:

- M14x1
- M16x1
- M17x1
- M20x1
- M25x1
- M27x1

The variably adjustable extractor bridge is adjustable in length, width and height and can therefore be used on practically any cylinder head. Correct alignment guarantees even traction and prevents the injector from jamming.



Part no.  
26124L



## Injector extraction tool set



Universal extraction tool for injectors by Delphi, Toyota, Siemens and Bosch. Particularly suited to jammed injectors.

Adapters for the following injector sizes are included in the set:

- M14x1
- M16x1
- M17x1
- M20x1
- M25x1
- M27x1

The variably adjustable extractor bridge is adjustable in length, width and height and can therefore be used on practically any cylinder head. Correct alignment guarantees even traction and prevents the injector from jamming.



① Hydraulic cylinder is not included! It has to be ordered separately.

Part no.

26126L

## Mechanical hydraulic cylinder



Mechanically driven hydraulic cylinder with 12 t traction. Additional hydraulic systems are not necessary. The pressure spindle drives the system.

- Drive: max. 67 Nm
- Stroke: 8 mm
- Size:  $\varnothing$  80 x 55mm
- max pressure: 700 bar
- Bore:  $\varnothing$  21.5 mm
- Ambient temperature: -10°C - 65°C



Part no.

26129L

## Hydraulic cylinder



Hollow piston hydraulic cylinder with 12 t traction

- Hydraulic connection: 3/8" - NPT
- Stroke: 8 mm
- Size:  $\varnothing$  80 x 55mm
- max pressure: 700 bar
- Bore:  $\varnothing$  21.5 mm



① To be used with hydraulic foot pump 301120L

Part no.

26127L

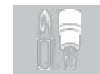



## Hydraulic cylinder 20 t



Hollow piston hydraulic cylinder with 20 tonnes of traction. Ideal to remove diesel injectors.

- Hydraulic connection: 3/8" NPT
- Stroke: 8 mm
- Size:  $\varnothing$  100 x 60mm
- max pressure: 700 bar
- Bore:  $\varnothing$  33 mm



① To be used with hydraulic foot pump 301120L

Part no.  
26128L

## Injector extraction tool set



Injector extraction tool set, specifically for:

Mercedes-Benz

- Mercedes-Benz with 2.1 l, 2.2 l and 3.0 l diesel engine
- Bosch injectors (2.1 l and 2.2 l)
- Delphi injectors (3.0 l V6)

suitable for:

- Mercedes-Benz Vito, Vario, CLK, Sprinter, Viano, M, G, GL, GLK, C, E, CLS, S and R class.



Part no.  
26151L

## Injector extraction tool set



Hydraulic set with feed shaft to extract injectors using a cylinder bridge.

Feed shaft fits Bosch, Delphi, Renault and Nissan injectors.

Incl. 12 t hydraulic cylinder.



① To be used with hydraulic foot pump 301120L

Part no.  
26152L

## Injector extraction tool set



Universal extractor tool for common rail diesel engines built by Denso, Siemens, Bosch and Delphi.

The injectors can be pulled into the supply line and then extracted using a collet. The enclosed bell hammer is suitable for moderately tight injectors.



Part no.  
26146L

## Injector extraction tool set

Universal extractor tool for common rail diesel engines built by Siemens, Bosch and Delphi. The enclosed bell hammer is used to remove the injectors quickly and safely. There is also an enclosed angle piece in order to use the bell hammer even in cramped conditions.

To ensure that the injector does not need to be opened, the set includes a screw-on adapter and an extractor claw.

Also suitable for Bosch GM 2.2L and Siemens piezo V2



Part no.  
26147L



## Injector / Injector-extraction tool set

specifically for VW / Audi / Seat / Škoda, suitable for

- SDI- / TDI- und TFSI- diesel engine (also pump/nozzle and common rail)
- FSI gasoline engines

for the professional dismantling and installation of injectors / injection valves as well as the unit pump nozzle. The striking weight also enables the removal of jammed elements.

Applicable like:

- VAG OEM T10133 / T10163 / T10055

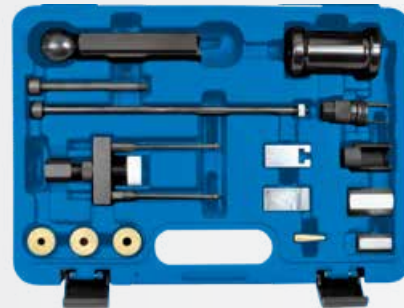

Part no.  
26107L



VW  
Seat  
Škoda  
Audi



## Injector extraction tool set

Injector extraction tool set, specifically for:

- BMW engines with M47TU, M57 and M57TU Motor Codes.

The special cylinder bridge is designed for this engine type and includes a roller bearing for mechanical removal using a spindle. The set also contains a reamer to clean the injector seat. The enclosed blow off stick is screwed into the glow plug opening to prevent dirt from entering the cylinder.



Part no.  
26148L



BMW



## Injector extraction tool set

Injector extraction tool set, specifically for Fiat, Opel and Suzuki with 1.3 l diesel engine.

Specifically for:

- Fiat 1.3 MJ 16V, Motor Codes: 169A1.000, 188A8.000, 188A9.000, 199A2.000, 199A3.000, 223A9.000
- Opel 1.3 CDTi, Motor Codes: Z13DTH, Z13DTJ, Z13D
- Suzuki 1.3 DDiS 16V, Motor Code: Z13DT

The injector is extracted using a spindle and an extra-short cylinder bridge.



Part no.  
26149L



Suzuki  
Opel  
Fiat





## Injector extraction tool set



Injector extraction tool set, specifically for:

Mercedes-Benz

- Mercedes-Benz A class (make 168 and 169) and B class (make 245) with engines from the 668 and 640 series'.

The set includes two mechanical traction devices, as the injectors always need to be pulled in pairs.



Part no.  
**26150L**

## Adapter set for injector removal, Hexagonal socket



particularly for tightly fitting injectors. Before use, the injector head must be removed and a suitable adapter screwed into the injector. The injector can then be removed in combination with the wheel hub striking tool.

- Hexagon socket bit 10 mm with bore hole and 12.5 mm (1/2") drive
- M 14 x 1.5 for outer thread
- M 17 x 1.0 for inner thread
- M 20 x 1.0 for inner thread
- M 25 x 1.0 for inner thread
- M 27 x 1.0 for inner thread



ⓘ Can only be used with 301055L!

Description	Part no.
Adapter set for injector removal	<b>301057L</b>

## Injector socket spanner set



for releasing the nozzle head in Siemens and Bosch injector nozzles, impact design, hexagonal profile, 12.5 mm (1/2") drive.

- wrench size 25/27 e.g. Siemens, in 2.0l HDI engines 10DW (PSA)
- wrench size 29 e.g. Bosch, for various CDI / HDI engines
- wrench size 30 e.g. Bosch, in Nissan / Renault 1.9l F9Q engines



Description	Part no.
4-piece	<b>03688L</b>

## Special sets of deep spanner sockets



A special range of open and closed deep spanner sockets for use with Lambda probes in all installation positions, thermal switches for the Opel cooler unit fan as well as for Diesel injection nozzles without damaging the fuel return line. Can be used on nearly all vehicles.

Includes the following sizes:

- Hexagon wrench size 29 x 90 mm, 12,5 mm (1/2") Drive, with slot
- Hexagon wrench size 22 x 90 mm, 10 mm (3/8") Drive, with slot
- Bi-hexagon wrench size 27 x 83 mm, 12,5 mm (1/2") Drive, with opening
- Hexagon wrench size 27 x 74 mm, 10 mm (3/8") Drive
- Hexagon wrench size 22 x 80 mm, 10 mm (3/8") Drive, with slot
- Hexagon wrench size 22, 10 mm (3/8") Drive, angled, slotted
- Hexagon wrench size 22, 12,5 mm (1/2"), angled, slotted

ⓘ Universal - lambda probes / thermal switches / injection nozzles



Opel  
Chrysler  
Fiat  
Ford  
Mercedes-Benz  
Seat  
Škoda  
VW

Description	Part no.
7-piece	<b>26045L</b>

## Lambda sensor release tool

12.5 mm (1/2") drive  
L-form with lateral offset drive



VW  
Škoda  
Seat  
Opel  
Mercedes-Benz  
Ford  
Fiat  
Chrysler

Size	Part no.
22 mm	26045L-1
22 mm	26045L-2

## Lambda sensor release tool

10 mm (3/8") drive  
L-form with lateral offset drive



Seat  
Škoda  
VW  
Opel  
Mercedes-Benz  
Ford  
Fiat  
Chrysler

Size	Part no.
22 mm	26045L-2

## Socket spanner bit, Hexagonal

7 mm (1/2"), slot width for 12.5 mm (1/2") drive



Size	Length	Part no.
29 mm	90 mm	26045L-3

## Socket spanner bit, Hexagonal

with 18 mm (3/8"), slot width for 10 mm (3/8") drive



Size	Length	Part no.
22 mm	90 mm	26045L-4

## Socket spanner bit, Double hexagon

closed-ended, with lateral opening for 12.5 mm (1/2") drive



Size	Length	Part no.
27 mm	83 mm	26045L-5

## Socket spanner bit, Hexagonal

with 8 mm (3/8"), slot width for 10 mm (3/8") drive



Size	Length	Part no.
22 mm	80 mm	26045L-6





## Socket spanner bit, Hexagonal

closed for 10 mm (3/8") drive



Size	Length	Part no.
27 mm	74 mm	26045L-7

## Special spanner sockets

Special assortment of open and closed spanner sockets for lambda probes in all installation positions, chrome-vanadium, burnished.



- 12.5 mm (1/2") drive:
  - 30 mm double hexagon, 80 mm long (Bosch, GM, DB)
  - 27 mm hexagon, 80 mm long (universal)
  - 28 mm double hexagon, 80 mm long (Alfa Romeo, Chrysler, Rover, MAN 2,5 TD, Volvo, Scania, HGV)
  - 21 mm double hexagon, 85 mm long (Ford, VAG)
  - 27 mm double hexagon, 85 mm long (Diesel injectors BMW M21, M41, M51-Motoren, Fiat, Ford, Peugeot, VW and Mercedes-Benz)
  - 22 mm double hexagon, 80 mm long (universal)
  - 27 mm double hexagon, 110 mm long (Citroën, Peugeot)
  - 22 mm double hexagon, 110 mm long (Audi, BMW, Mercedes-Benz, VW, Volvo)
  - 22 mm double hexagon, 150 mm long (BMW)
  - 20 mm hexagon, 80 mm long, slotted (universal)
  - 19 mm double hexagon, 80 mm long (VW, Audi, Seat)
  - 17 mm double hexagon, 80 mm long (BMW, Mercedes-Benz, Renault)
  - 22 mm double hexagon, 50 mm long, offset (universal)
- 10 mm (3/8") drive:
  - 22 mm hexagon, 30 mm long, offset (universal)



MAN  
Rover  
Chrysler  
BMW  
Alfa Romeo  
Volvo  
Scania LKW  
Renault  
Peugeot  
General Motors  
Citroën  
Audi  
Fiat  
Ford  
Mercedes-Benz  
Opel  
Seat  
Škoda  
VW

① universal - lambda probes / thermal switches / injection nozzles

Description	Part no.
14-piece	26042L

## Injector remover

for the removal of tightly fitting injectors from cylinder heads in common rail diesel engines.

The set also includes a special inner hexagon socket 10 mm with 12.5 mm (1/2") drive and a spanner socket wrench size 29 with 12,5 mm (1/2") and 22 mm hexagon drive for removing the nozzle head from injector nozzles (e.g. Bosch 8658352) in CDI engines including Mercedes-Benz OM611 / 612 / 613 and HDI engines.



Mercedes-Benz



Description	Part no.
4-piece	03667L

## Assortment of injector removal tools

for Siemens or Bosch injectors

- with special hammer 1.70 kg
- extra short: only 225 mm
- overall length 350 mm
- for inner thread M14x1.5 and M17x1.0
- for outer thread M27x1,0
- ball joint 360°

for Mercedes-Benz CDI engines OM611, OM612, OM613



Mercedes-Benz



Description	Part no.
Tool set complete	03686L

## Nozzle expulsion tool



Mercedes-Benz

Nozzle expulsion tool for Mercedes-Benz CDI engines of the series OM611, OM612, OM613. The tight injectors can be expelled by means of a drawbar, impact weight and extractor claw. The scope of delivery also includes an adapter that is screwed directly onto the nozzle in cramped conditions and then driven out.

- adapter with core thread M27x1,0
- extractor claw with inside dimension 13,5 mm



Description	Part no.
Complete tool set	03680L
Removal claw for injector	03661L
Removal nut	03662L
Impact weight	03666L
Adapter M16 x 1.5	03666L-ADA

## Injector extraction fork



Mercedes-Benz  
Kia  
Hyundai

Injector extraction fork with adapter for use with a bell hammer.

Matches Delphi piezo injectors.

- Mercedes-Benz 2.1 CDI with OM651 engine
- Hyundai and Kia with 1.5 Dfi engine, Injector Codes: EMBR, EJBR and EJDR

Dismantling claw, interior dimensions 16.2 mm



Part no.  
26153L

## Special screwdriver bit set



Fiat

for the removal of the common rail injector inner bolt attachment e.g. on Bosch injectors in PSA (HDI) and Mercedes-Benz (CDI) engines.

- wrench size 10 mm with 7.5 mm bore hole and depth 35 mm
- 12.5 mm (1/2") drive, 75 mm long

Suitable for:  
Fiat Ducato, Iveco Daily 2.3l and 3.0l common rail diesel etc.



Size	Length	Part no.
10 mm	75 mm	03663L

## Cleaning set for injector seat and shaft



To remove soot residue and other contaminants from the injector seat and shaft. The opening to the combustion chamber can be closed before cleaning to prevent particles from entering the combustion chamber.



Part no.  
03694L



## Cleaning set for injector seat and shaft

for Bosch and Delphi injectors.  
For eliminated soot residue - particles cannot fall into the combustion chamber.  
Contains:

- guide pin for seal seat milling cutter with 19 mm outer hexagon
- 3 tapered sleeves for the guide pins 17 / 18.4 / 19 mm
- 3 milling heads with 17 x 19 mm diameter for Mercedes-Benz CDI / 17 x 17 mm diameter for BMW, Peugeot, Citroën, Renault / 17 x 17 mm diameter 30° chamfered for Fiat and Iveco
- injector gasket puller
- articulated shaft with 6.3 mm (1/4") hexagon bit holder for the drill
- holder for brushes with 6.3 mm (1/4") hexagon bit holder
- 2 brush heads with 19.5 mm diameter
- 2 long, thin brushes for nozzle needle shaft
- 6 guide plugs for sealing the nozzle needle shaft with holder for removal and fitting



**⚙️**  
Fiat  
Citroën  
BMW  
Iveco  
Mercedes-Benz  
Peugeot  
Renault

**Description**  
21-piece

**Part no.**  
03689L

## Brush set

comprising a handle with extension and 36 assorted brushes with 1/4" drive and 8-9-10-11-12-13-14-15-16-17-18-19 mm diameter for cleaning and deburring cylinders, bushings, pipes and other workpieces with

- nylon facing
- brass facing
- steel facing

Application examples are:

- brake callipers sleeve
- O-ring cut-ins
- injector seat
- valves on exhaust gas recirculation
- inlets and outlets
- crossbar seal on injection lines on Opel cylinder heads



**⚙️**  
VW  
Opel  
Mercedes-Benz

⚠️ when used with machine only use clockwise running

**Description**  
38-piece with 1/4" drive

**Part no.**  
62330L

## Cleaning brush

for the fast elimination of soot particle residue in the glow plug shaft and injector needle shaft.

- steel brush dia. 9 mm x 105 mm



**Length**  
310 mm

**Part no.**  
03664L

## Injector gasket puller

for taking out difficult to remove copper rings in the injector shaft of fuel injected engines.

- for gaskets with 7.2 - 9 mm inner diameter



**Part no.**  
03684L



## Injector seat cleaning set

for VAG engines 2.0 TDi PD, Motor Code: BKD  
Cutter diameter: 17.6 mm



Part no.  
**03697L**



## Injectors seal seat-cutter set

for repairing seal seats during injector removal.

- guide with 19 mm outer hex
- 15 x 19 mm cutters - various models
- 17 x 17 mm cutters - BMW, Peugeot, Citroën, Renault
- 17 x 19 mm cutters - Mercedes-Benz CDI
- 17 x 21 mm cutters angled - Fiat / Iveco



Part no.  
**03683L**

BMW  
Citroën  
Fiat  
Iveco  
Mercedes-Benz  
Peugeot  
Renault



Description  
5-piece

Part no.  
**03683L**

## Injector cleaner

To clean and restore the injector seal surface



Part no.  
**03695L**



## Compressed air adapter

Used to emit compressed air from the cylinder to ensure that residue or chips cannot enter the combustion chamber during repair or cleaning. Air inlet above the injector seat.

- Size:  $\varnothing$  19mm



Part no.  
**03718L**



## Glow Plugs

### Glow plug pliers

For removing and installing difficult to access glow plug sockets in modern diesel engines, e.g. from Audi, BMW, Mercedes, VW



Part no.  
**402002**

Mercedes-Benz  
BMW  
Audi  
VW



Description

Length

Part no.

Straight

240 mm

**402002**

Bent

240 mm

**402003**



## Glow-plug socket spanner, PSG



Glow plug socket spanner for the installation and dismantling of pressure transducer - glow plug / PSG glow plug with 12 mm spanner size. Including 5 protective caps for the electrical plug-in connection.

VW  
Škoda  
Seat  
Opel  
Audi

- No intrusion of dirt and moisture during repair
- Protection of the integrated electronics against damage and electrostatic charge
- Deep design-implementation for the reception of the glow plug along with protective cap
- The ball latching holds removed glow plug in the insert nut



Part no.  
**03120L**

## Glow and spark plug tool set



to replace inaccessible glow and spark plugs in various vehicle models in the torques specified by the manufacturer.

Alfa Romeo  
Fiat  
Lancia  
Mercedes-Benz  
Opel  
VW

- 10 mm (3/8") torque wrench 10-50 Nm
- 10 mm (3/8") extension, 150 mm
- 6 universal sockets for glow and spark plugs
  - 8 mm hex nuts (e.g. for VW T4 und T5, Opel Z13 DT, Mercedes-Benz CDI engines OM 640 + 642)
  - 9 mm hex nuts (e.g. for Opel 1.9 I CDTI engines and for 1.9 I JTD and 2.4l engines Fiat / Alfa Romeo)
  - 10 mm hex nuts
  - 12 mm hex nuts
  - 14 mm double-hex
  - 16 mm hex nuts (e.g. 4 cyl. VAG engines, without dismantling the exhaust pipe!)



### Description

8-piece

### Part no.

**Z315**

## Glow plug inserts



120 mm long, with torque limitation to prevent damage.

- 8 mm - 15 Nm
- 10 mm - 18 Nm
- 12 mm - 18 Nm



### Description

3-piece

### Part no.

**03110L**

## Special spanner socket, Hexagonal



with rubber trap, for glow (TDI) and spark plugs with 10 mm (3/8") drive that are difficult to reach

Opel  
Mercedes-Benz  
VW  
Fiat  
Lancia



Description	Size	Length	Part no.
Jointed sockets e.g. for VW T4 and T5, Opel Z13 DT, Mercedes-Benz CDI engines OM 640 + 642 in the A-Class from 2004, B-Class etc.	8 mm	80 mm	<b>03647L</b>
Jointed socket e.g. for 1.9 I CDTI engines in the Opel Vectra C, Signum and Astra H as well as 1.9 I JTD engines in the Alfa Romeo 147, 156, GT and Fiat Stilo as well as 2.4 I engines in the Alfa 166 and Lancia Thesis	9 mm	80 mm	<b>03648L</b>
Jointed socket	10 mm	80 mm	<b>03645L</b>
Jointed socket	12 mm	80 mm	<b>03644L</b>
Jointed socket	14 mm	80 mm	<b>03642L</b>
Bi-hex jointed socket e.g. for C5 2.0I HPI / Renault Clio, Twingo 1.2I 16V / MB-engine M 156	14 mm	80 mm	<b>03649L</b>
Jointed socket e.g. for 4-cyl. VAG engines without dismantling the intake pipe	16 mm	80 mm	<b>03646L</b>

## Special spanner socket, Hexagonal, Extra long

for glow plugs (TDI + CDI), 10 mm (3/8") drive that are difficult to reach



Audi  
Mercedes-Benz  
Seat  
Škoda  
VW  
Honda  
Renault



Description	Size	Length	Part no.
Jointed socket for TDI+CDI (extra long)	10 mm	140 mm	<b>03650L</b>

## Vibration pneumatic impact screwdriver

6.3 mm (1/4") drive



Especially for the removal of jammed glow elements through several impact pulses and 4-stage adjustable loosening torque.

- extra small and handy
- right/left direction of rotation
- quick-action coupling
- loosening torque from 20 to 50 Nm
- weight 2.12 kg
- hose connection: 6,3 mm (1/4")
- sound pressure: 95 dB (A)
- 5 IMPACT hexagon sockets 50 mm long, 8 - 9 - 10 - 11 - 12 mm
- extension 50 mm
- power joint 6,3 mm (1/4")



Loosening torque adjustable in 4 stages:

- stage 1: 20 Nm
- stage 2: 30 Nm
- stage 3: 40 Nm
- stage 4: 50 Nm

Description	Part no.
8-piece	<b>S3224</b>

## Easy-Heater

for the fast and precise heating of rusted, seized bolts and nuts or micro-encapsulated connections. Thanks to the inductive pinpoint heating, there is no need to use a welding torch which would lead to other components heating up as well. The additional generator with cooling system guarantees permanent use without unnecessary breaks.

Including 3 heating coils which can be shaped flexible and have a long service life:

- 25 mm at the side
- 20 mm vertical
- "pancake" coil



① The device fulfills the European standards!

Description	Part no.
5-piece	<b>62100L</b>
Lateral Heating Coil out of 62100L	<b>62100L-1</b>
Vertical Heating Coil out of 62100L	<b>62100L-2</b>
Pancake Coil out of 62100L	<b>62100L-3</b>
Flexible Heating Coil for 62100L	<b>62100L-4</b>
Heating Coil for Glow Plugs for 62100L	<b>62100L-5</b>
Heating Coil for Injectors for 62100L	<b>62100L-6</b>



## Glow plug removal tool



Mercedes-Benz

By turning and pulling the CDI plug simultaneously with the tool, the combustion residue on the shaft of the glow plug pin is stripped off and the risk of pulling the head of the plug is greatly reduced. Observe the breaking torque of the glow plug!



ⓘ Attention, please mind the breaking torque of the glow plug!

Part no.  
**03660L**

## Thread tapping set



in plastic case, especially for the cleaning and re-cutting of even deep-seated spark and glow plug threads e.g. for BMW, Mini, Citroën, Peugeot, Renault, Mercedes-Benz, VW

Dimensions:

- M8 x 1.0, wrench size drive 13 mm, 100 mm long
- M10 x 1.0, wrench size drive 13 mm, 100 mm long
- M12 x 1.25, wrench size drive 13 mm, 120 and 250 mm long
- M14 x 1.25, wrench size drive 13 mm, 120 and 250 mm long
- M16 x 1.5, wrench size drive 18 mm, 70 mm long



Renault  
Peugeot  
Mini  
Mercedes-Benz  
Citroën  
BMW  
VW



Description  
7-piece

Part no.  
**03669L**

## Glow plug tool set



Mercedes-Benz

for removing dirt in the glow plug channel and also for removing plugs that are stuck in place. Ideal for Mercedes-Benz CDI-engines.

- reamer M10 x 1.00
- (4-, 5- and 6-cylinder engines OM611, 612, 613, and Smart CDI R660)
- reamer M12 x 1.25
- (4-valve engines OM604, 605, 606)
- glow plug puller
- for glow plugs with wrench size (OM611, 612, 613)



Description  
3-piece

Part no.  
**03685L**

## Spiral groove sockets, Spiral groove



6.3 mm (1/4") drive, 6-part for removing electrodes from torn off glow plugs in cylinder head while still installed, in plastic case

- 2,60 mm - 3,20 mm - 3,50 mm - 4,50 mm - 6,50 mm - 8,25 mm



Description  
6-piece

Part no.

	<b>05535L</b>
Replacement sockets 2,60 mm	<b>05535L-2,60</b>
Replacement sockets 3,20 mm	<b>05535L-3,20</b>
Replacement sockets 3,50 mm	<b>05535L-3,50</b>
Replacement sockets 4,50 mm	<b>05535L-4,50</b>
Replacement sockets 6,50 mm	<b>05535L-6,50</b>
Replacement sockets 8,25 mm	<b>05535L-8,25</b>

## Glow plug repair tool set

for the quick and professional removal of damaged and snapped glow plug electrodes without removing the cylinder head.



Description	Part no.
21-piece	03701L
M8x1	03703L
M9x1	03702L
M10x1 and M10x1,25	03700L

## Glow plug repair tool set

for the fast and professional drilling out of damaged or torn off glow plugs without removing the cylinder head. Makes the re-cutting or repairing of the threaded body and cleaning of the electrode bore hole possible. The exact drilling depth and drilling angle are maintained precisely thanks to the guide sleeves. Suitable for:

M10 x 1 glow plug thread seats e.g. VW Passat, Audi with 2.5 L / 2.7 L / 3.0 L V6 TDI engines

Contains:

- cover plate for intake channels
- compressed air adapter for the injector shaft
- drill dia. 9.1 mm for M10 x 1
- drill dia. 11.1 mm for M12 x 1
- thread tap with guide sleeve for M10 x 1
- thread tap with guide sleeve for M12 x 1
- 10 threaded inserts for M10 x 1 with outer thread M12 x 1
- thread tap M6 x 1.25
- removal tool
- 2 reamers dia. 4.8 mm, long and short
- reamer dia. 5.8 mm, long
- 3 guide sleeves with outer dia. 17.5 mm - 38 mm length: inner dia. 9 mm and dia. 13 mm - 63 mm length: 13 mm inner dia.
- thread cutter holder 240 mm long with square seat from 2.4 - 5.5 mm and 6.3 mm (1/4") drive
- 3 electrode removal tools for 2.5 - 3.5 - 4 mm



Description	Part no.
28-piece	03671L

## Thread repair tool set

for glow plugs with M8x1 mm, M10x1 mm thread seat.



Description	Part no.
16-piece	03672L

## Glow plug repair tool set

for the quick and professional removal of damaged and snapped glow plug electrodes without removing the cylinder head.

This set is designed for Mercedes-Benz CDi diesel engines with M10x1 and M10x1.25 glow plugs



Mercedes-Benz

Part no.
03706L



## Glow plug repair tool set

Designed for 1.3 l diesel engines by the Fiat Group with M8x1 glow plugs

for the quick and professional removal of damaged and snapped glow plug electrodes without removing the cylinder head.



Fiat

Part no.  
03705L

## Glow plug repair tool set

Designed for 2.3 l and 3.0 l diesel engines by the Fiat Group with M8x1 glow plugs

for the quick and professional removal of damaged and snapped glow plug electrodes without removing the cylinder head.



Fiat

Part no.  
03704L

## Glow plug repair tool set

Designed for Citroën and Renault 2.0 l HDi diesel engines (DW10) with M10x1 glow plugs

for the quick and professional removal of damaged and snapped glow plug electrodes without removing the cylinder head.



Citroën  
Peugeot

Part no.  
03708L

## Glow plug repair tool set

Designed for Renault diesel engines 1.5 l (K9K), 1.9 l (F9Q), 2.2 l and 2.5 l with M10x1 glow plugs

for the quick and professional removal of damaged and snapped glow plug electrodes without removing the cylinder head.



Renault

Part no.  
03707L

## Glow plug repair tool set

Designed for Renault 2.0 l dCi diesel engines (M9R) with M10x1 glow plugs

for the quick and professional removal of damaged and snapped glow plug electrodes without removing the cylinder head.



Renault

Part no.  
03709L

## Glow plug thread repair set

Thread repair set for glow and spark plugs, including thread repair sleeves with collar.

Sizes included: M8x1, M9x1, M10x1, M10x1.25, M12x1.25, M14x1.25



Part no.  
**03717L**

## Thread repair set

Special tool for replacing M10x1 glow plug thread on Mercedes-Benz engines of the series OM611, OM612, OM613

- starter
- tap
- 16 threaded inserts



Mercedes-Benz

Description	Part no.
Complete set	<b>03690L</b>
Threaded insert	<b>03691L</b>
Glow plug thread starter	<b>03692L</b>
Glow plug thread finisher	<b>03693L</b>

## Removal set for the glow plug electrode

for the quick removal of snapped glow plug electrodes without removing the cylinder head.

- for glow plugs M8x1, M9x1, M10x1 and M10x1,25



Description	Part no.
M8 x 1, M9 x 1, M10 x 1 and M10 x 1,25	<b>03711L</b>

## Removal set for the glow plug electrode

for the quick removal of snapped glow plug electrodes without removing the cylinder head.



Description	Part no.
M8 x 1 and M9 x 1	<b>03713L</b>

## Removal set for the glow plug electrode

for the quick removal of snapped glow plug electrodes without removing the cylinder head.



Description	Part no.
M10 x 1, M10 x 1,25	<b>03712L</b>



## Removal set for the glow plug electrode

for the quick removal of snapped glow plug electrodes without removing the cylinder head.

Designed for Citroën, Peugeot, Ford with 1.4 l - 1.6 l diesel engines and M8x1 glow plugs



**Peugeot**  
**Ford**  
**Citroën**

**Description**  
M8 x 1

**Part no.**  
03715L

## Glow plug socket cleaning set

Reamer with adapter for glow plugs M8x1, M9x1, M10x1 und M10x1.25.

Universal set for cleaning the glow plug socket and glow plug shaft to ensure a professional seal.



**Part no.**  
03714L

## Glow plug socket cleaning set

Set for cleaning the glow plug socket and glow plug shaft, specifically for Renault and Toyota.

- Renault M9R engine: M10x1
- Toyota: M10x1.25



**Renault**  
**Toyota**

Reamer with adapter for glow plugs M10x1 und M10x1.25

**Part no.**  
03716L

## Cleaning set for glow plug recess

for the simple removal of deposits and burnt-on residue in the glow plug channel, e.g. during glow plug replacement. Cleaning is absolutely necessary, as the deposits may cause a hot-spot which can result in a reoccurring breakdown of the glow plug.

TIN coated  
For threads M10 and M12

Assignment list:

- M10 x 1.0 / 107 mm long: Glow plug Beru GN003, Bosch 0 250 202 142, NGK D-Power 11, Y-745U  
e.g. Chrysler, Jeep, Mercedes-Benz
- M10 x 1.25 / 137 mm long: Glow plug Beru GN042, NGK D-Power 45, Y-542J  
e.g. Toyota Auris, Corolla, Yaris, Yaris Verso
- M12 x 1.25 / 59 mm long: Glow plug Beru GV631, GV657, GN954, GN858, GN959, GN908, GN959, GN022, GN 030, Bosch 0 250 201 017, 0 250 201 012, 0 250 201 043, 0 250 201 055, 0 250 201 050, 0 250 202 034, 0 250 201 050, 0 250 201 049, 0 250 201 053, NGK Y-907R, Y-909R, Y-913J, D-Power 15, Y-916J, D-Power 6, Y-918J, D-Power 2, Y-924J, D-Power 1, Y-933J, D-Power 25, Y-937J, D-Power 5, Y-939J, D-Power 43  
e.g. Alfa, Audi, BMW, Citroën, Fiat, Ford, Jeep, Land Rover, Mercedes-Benz, Nissan, Opel, Peugeot, Renault, Rover, Seat, Volvo, VW
- M12 x 1.25 / 94 mm long: Glow plug Beru GN860, Bosch 0 250 201 054, 0 250 201 035, NGK D-Power 16, Y-925J, D-Power 30, Y-930U  
e.g. Mercedes-Benz



**Alfa Romeo**  
**Audi**  
**BMW**  
**Chrysler**  
**Citroën**  
**Fiat**  
**Ford**  
**Jeep**  
**Land Rover**  
**Mercedes-Benz**  
**Nissan**  
**Opel**  
**Peugeot**  
**Renault**  
**Rover**  
**Seat**  
**Toyota**  
**Volvo**  
**VW**

**Description**  
4-piece

**Part no.**  
03668L



## Glow plug reamer

TIN-coated

- For the simple removal of deposits and burnt-on residue in the glow plug channel, e.g. during changing of glow plugs

Glow plug

- Beru GN003
- Bosch 0 250 202 142
- NGK D-Power 11, Y-745U

E.g. Chrysler, Jeep, Mercedes-Benz



Jeep  
Chrysler  
Mercedes-Benz



Thread	Length	Part no.
M 10 x 1.0	107 mm	03668L-1
M 10 x 1,25	137 mm	03668L-2
M 12 x 1,25	59 mm	03668L-3
M 12 x 1,25	94 mm	03668L-4

## Compressed air adapter

Used to emit compressed air from the cylinder to ensure that residue or chips cannot enter the combustion chamber during repair or cleaning.  
Air inlet above the injector seat.

- Size:  $\varnothing$  19mm



Part no.  
03718L

## Compressed air adapter

Used to emit compressed air from the cylinder to ensure that residue or chips cannot enter the combustion chamber during repair or cleaning.

- For glow plug threads with M8x1 and M10x1



Part no.  
03696L

## Cleaning brush

for the fast elimination of soot particle residue in the glow plug shaft and injector needle shaft.

- steel brush dia. 9 mm x 105 mm



Length  
310 mm

Part no.  
03664L

## Spark plug connector pliers

with strong insulated handles. Also suitable for pulling off injection lines



Description	Length	Part no.
Normal shape	200 mm	402001

# Ignition





## Spark plug connector pliers



for extremely deep-seated spark plugs on multivalve engines. The gripping surface is calibrated for the safe gripping of the plug connector

Mercedes-Benz  
Suzuki



Length  
290 mm

Part no.  
402006SB

## Special spark plug connector removal tool



for removing and inserting on V6 cylinder engines with VAG VR6 engines, Mercedes-Benz Vito, Smart, Ford 24V engines as well as most 16V engines to avoid cable damage



Audi  
Seat  
Škoda  
VW  
Ford  
Mercedes-Benz

Length  
300 mm

Part no.  
402010L

## Ignition module removal set

for problem-free and easy removal and installation of ignition modules.

Opel  
Fiat  
Chevrolet  
Alfa Romeo  
Vauxhall

- rounded handle design allows work to be performed comfortably, damage-free and injury-free
- material: Plastic handle, tension extension made of S45C chrome-plated steel

Suitable for the following vehicles:

- Chevrolet Aveo Cruze, Vauxhall / Opel Agila-A, Astra-F, Astra-G, Astra-H, Astra-J, Calibra, Combo, Corsa-B, Corsa-C, Corsa-D, Frontera-A, Frontera-B, Insignia, Meriva-A, Meriva-B, Omega-B, Signum, Tigra-A, Tigra-B, Vectra-B, Vectra-C, Zafira-A, Zafira-B: 3- and 4-cylinder petrol injection engines (1.0 l, 1.2 l, 1.4 l, 1.6 l, 1.8 l, 2.0 l, 2.2 l)
- Fiat Croma (1.8 l)
- Alfa Romeo 159 (1.8 l)

Engine codes:

LDD, LDE, LLU, LUH, LUJ, 2HO, A10XEP, A14NEL, A14NET, A14XER, X14NZ, X14SZ, X14XE, A16LET, A16XER, X16SZR, X16XE, X16XEL, A18XER, X18XE, X20SE, X20XEV, X22SE, X22XE, Y22SE, Z10XEP, Z12XE, Z12XEP, Z14XE, Z14XEL, Z14XEP, Z16LEL, Z16LER, Z16LET, Z16XE, Z16XER, Z16YNG, Z18XE, Z18XER, 20LEH, Z20LER, C22SEL



Part no.  
26170L

## Spark plug removal set



for spark plugs on VW engines with power output stage, prevents damage and expensive replacement of the coil and the housing

Audi  
VW

- TYPE A (26 mm):  
VW Golf, Bora, Beetle, Lupo, Passat, Touran, T4, Audi A2
- TYPE B (18 mm):  
Bora, Golf, Passat, Sharan, Touareg, Phaeton, T5
- TYPE C (43 mm):  
8 and 12 cylinder engines such as Phaeton
- TYPE D (35 mm):  
FSI engines on Golf, Touran, Passat and Eos as well as Audi A4 und A6



Description  
4-piece

Part no.  
10645L

## Ignition coil fitting handles

for professional work on ignition coils with power output stage



VW



Description	Clamping width	Part no.
FSI engines on Golf/Bora, Polo, Lupo, Touran 1.4 and 1.6 ltr., New Beetle, Passat, T4 and Phaeton	26 mm	<b>10640L</b>
Bora, Golf, Passat, Sharan, Touareg, Phaeton, T5	18 mm	<b>10641L</b>

## Spark plug socket, Hexagonal

Hexagon version with rubber trap, matt chromed



CrV

12.5



Size	Length	Part no.
16 mm	70 mm	<b>07620L-ZK16</b>
21 mm	66 mm	<b>07620L-ZK21</b>

## Spark plug socket, Hexagonal, Extra long

with rubber trap, extra long



12.5



Drive	Size	Length	Part no.
	16 mm	60 mm	<b>03101SB</b>
	21 mm	60 mm	<b>03102SB</b>
	16 mm	60 mm	<b>03103SB</b>

## Spark plug socket, Hexagonal, Extra long

with permanent magnet, extra long



10



Drive	Size	Length	Part no.
	16 mm	65 mm	<b>03150SB</b>
	21 mm	65 mm	<b>03155SB</b>
	16 mm	65 mm	<b>03160SB</b>
	21 mm	65 mm	<b>03165SB</b>

## Spark plug socket, Hexagonal, Extra long

with rubber trap, extra long



10



**Yamaha  
Suzuki  
Kawasaki  
Honda**

Drive	Size	Length	Part no.
	18 mm	60 mm	<b>03105SB</b>

## Special spark plug key, Hexagonal, Extra narrow

for deep-seated plugs, extra slim, for 16V engines



12.5



Size	Length	Part no.
16 mm	270 mm	<b>03605L</b>





## BMW Spark plug socket with joint, Double hexagon



BMW Spark plug socket joint and rubber insert.

BMW

For the dismantling and assembly of spark plugs with a twelve-edge profile. An integrated rubber insert serves to fix the spark plug.



Size	Part no.
14 mm	03630L
16 mm	03631L
21 mm	03632L

## Special spanner socket, Hexagonal



with rubber trap, for glow (TDI) and spark plugs with 10 mm (3/8") drive that are difficult to reach

Opel  
Mercedes-Benz  
VW  
Fiat  
Lancia



Description	Size	Length	Part no.
Jointed sockets e.g. for VW T4 and T5, Opel Z13 DT, Mercedes-Benz CDI engines OM 640 + 642 in the A-Class from 2004, B-Class etc.	8 mm	80 mm	03647L
Jointed socket e.g. for 1.9 I CDTI engines in the Opel Vectra C, Signum and Astra H as well as 1.9 I JTD engines in the Alfa Romeo 147, 156, GT and Fiat Stilo as well as 2.4 I engines in the Alfa 166 and Lancia Thesis	9 mm	80 mm	03648L
Jointed socket	10 mm	80 mm	03645L
Jointed socket	12 mm	80 mm	03644L
Jointed socket	14 mm	80 mm	03642L
Bi-hex jointed socket e.g. for C5 2.0I HPI / Renault Clio, Twingo 1.2I 16V / MB-engine M 156	14 mm	80 mm	03649L
Jointed socket e.g. for 4-cyl. VAG engines without dismantling the intake pipe	16 mm	80 mm	03646L

## Special spanner sockets



for 14 mm spark plugs in all installation positions, 3/8" drive

Citroën  
Mini  
Peugeot  
Renault



ⓘ 14 mm for HPI engines

Description	Size	Part no.
2-piece	14 mm	03640L
Long socket	14 mm	03641L
Jointed socket	14 mm	03642L

## Special spanner socket, Double hexagon, Extra deep

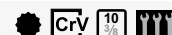

for innovative spark plugs with bi-hex 3/8" drive, O-ring on the inside holds the plugs tight safely.

BMW  
Citroën  
Mercedes-Benz  
Mini  
Renault  
Toyota



Description	Size	Length	Part no.
e.g. for Citroën C5 2.0I HPI / Mini 1.4 + 1.6I / Peugeot 207 / Renault Clio, Kangoo, Twingo 1.2I 16V / BMW 2.5 + 3.0I / MB engine M 156 in the new M-Class, CLK, E-Class, CL, CLS, S-Class, R-Class	14 mm	90 mm	03149L
e.g. for Mitsubishi	16 mm	90 mm	03146L

## Glow and spark plug tool set

to replace inaccessible glow and spark plugs in various vehicle models in the torques specified by the manufacturer.

- 10 mm (3/8") torque wrench 10-50 Nm
- 10 mm (3/8") extension, 150 mm
- 6 universal sockets for glow and spark plugs
  - 8 mm hex nuts (e.g. for VW T4 und T5, Opel Z13 DT, Mercedes-Benz CDI engines OM 640 + 642)
  - 9 mm hex nuts (e.g. for Opel 1.9 I CDTI engines and for 1.9 I JTD and 2.4l engines Fiat / Alfa Romeo)
  - 10 mm hex nuts
  - 12 mm hex nuts
  - 14 mm double-hex
  - 16 mm hex nuts (e.g. 4 cyl. VAG engines, without dismantling the exhaust pipe!)



Alfa Romeo  
Fiat  
Lancia  
Mercedes-Benz  
Opel  
VW



Description  
8-piece

Part no.  
Z315

## Spark plug key, Hexagonal

with joint and rubber trap, insulated handle



Size	Length	Part no.
16 mm	235 mm	03601SB
21 mm	235 mm	03602SB

## Spark plug key, Hexagonal

with joint and rubber trap, insulated handle



Description	Size 1	Size 2	Length	Part no.
Double socket	16 mm	21 mm	105 mm	03603L

## Spark plug tool set, Hexagonal

contains

- 1 jointed ratchet wrench
- 2 extensions (37.5 + 75 mm)
- 2 spark plug sockets (16 + 21 mm)



Description  
5-piece

Part no.  
03710SB

## Spark plug key, Hexagonal, Extra long

Extra long, sturdy T- handle and joint, with rubber trap

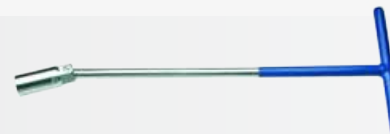

Description	Size 1	Length	Part no.
Double socket	16 mm	374 mm	03610L
	21 mm	143 mm	03620L



## Thread tapping set

in plastic case, especially for the cleaning and re-cutting of even deep-seated spark and glow plug threads e.g. for BMW, Mini, Citroën, Peugeot, Renault, Mercedes-Benz, VW

Dimensions:

- M8 x 1.0, wrench size drive 13 mm, 100 mm long
- M10 x 1.0, wrench size drive 13 mm, 100 mm long
- M12 x 1.25, wrench size drive 13 mm, 120 and 250 mm long
- M14 x 1.25, wrench size drive 13 mm, 120 and 250 mm long
- M16 x 1.5, wrench size drive 18 mm, 70 mm long



**Renault**  
**Peugeot**  
**Mini**  
**Mercedes-Benz**  
**Citroën**  
**BMW**  
**VW**

**Description**  
7-piece

**Part no.**  
**03669L**

## Spark plug thread repair tool set

for fast and professional repairs to faulty spark plug threads in cylinder heads for inner thread M14 x 1.25 mm without removing the cylinder head. In one working cycle, the residue thread is removed and the new enlarged thread is cut. The spark plug then fits tightly in the thread and is compression-proof again. For universal use with spark plugs with conical seal seat as well.

- 1 special drill M16 x 1.25 mm
- with 16 mm hexagon drive
- 15 threaded inserts 11 + 16 + 19 mm



**Description**

- 16-piece
- Bushing, height 11.3 mm
- Bushing, height 16.0 mm
- Bushing, 19.0 mm
- Special drill

**Part no.**

- 10610L**
- 10701L**
- 10702L**
- 10703L**
- 10900L**

## Glow plug thread repair set

Thread repair set for glow and spark plugs, including thread repair sleeves with collar.

Sizes included: M8x1, M9x1, M10x1, M10x1.25, M12x1.25, M14x1.25



**Part no.**  
**03717L**

## Spark plug brush

made of brass wire, for gentle cleaning of the spark plug electrode.



**Length**  
150 mm

**Part no.**  
**93900L**

## Contact file

e.g. for cleaning spark-plug contacts



**Length**  
150 mm

**Part no.**  
**93605L**





## Chuck key set for V-ribbed belts, Double hexagon



for pre-tensioning the tensioning device for auxiliary belts e.g. for Audi, VW, Ford, Seat, Škoda etc.

- With angled tips (ca. 45°), ideal where space is tight in the engine compartment
- 19 mm wrench size especially needed for Audi A4, VW Passat from '97 TDI (pump/blast pipe)
- Non-slip handle for safe work
- In a practical case
- Length 460 mm each



**Description**  
5-piece,  
13-15-16-17-19 mm

**Part no.**  
**10557L**

## Chuck key set for V-ribbed belts, E Profile



for pre-tensioning the tensioning device for auxiliary belts e.g. Opel 1.2 L 12V as well 1.2 L and 1.4 L 16V engines with double camshaft

- With angled tips (ca. 45°), ideal for cramped conditions in the engine compartment
- Non-slip handle for safe work
- In a practical case
- Length 460 mm each



**Description**  
5-piece,  
E10-E12-E14-E16-E18

**Part no.**  
**10558L**

## Power impact driver



Perfect for various applications such as releasing belt pulley retaining bolts, compensation shaft washers, etc.

- enables high loosening torque even in tight spaces
- with double hand-protection insulation



**Length**  
620 mm

**Part no.**  
**05919L**

## Belt pulley remover



e.g. for generators, air-conditioning systems, water pumps

- tension range 40 - 168 mm
- including 10 mm Allen key



**Part no.**  
**10579L**



## Clamping key for V-ribbed belts

for VAG vehicles WITHOUT tensioning roller.  
Here, the belt is tensioned via the spring-loaded generator. With the aid of this key, the generator can be turned accordingly to slacken the belt, e.g. during replacement work.

The 12,5 mm (1/2") drive is attached in a star shape and thus allows the tool to be inserted in different ways depending on the space available.

The pins are knurled, reducing the risk of the key slipping out of the generator.

Used as OE no VAG 3297 and Seat U-40050.



Škoda  
Seat  
Audi  
VW

Part no.  
**10582L**

## Clamping key for V-ribbed belts

for ribbed V-belts on vehicles with automatic tensioning roller e.g. Audi, VW Golf / Passat / Polo / T4.

It can be used to loosen the automatic tensioning roller during replacement work. Thanks to the interchangeable head, the tool can be adapted for individual use.



VW  
Škoda  
Seat  
Audi

Part no.  
**10583L**

## Arrester key for crankshaft VAG

for VW 1.4l - 1.6l and 2.0l engines

- for arresting the crankshaft belt pulley on 4-valve engines with pin diameter 11.5 mm
- for arresting the crankshaft toothed belt wheel on 2-valve engines
- M8 bolt

suitable for:

- VW Bora, Caddy, Golf, Lupo, New Beetle, Polo, Sharan, Touran, Transporter
- Audi A2, A3, A4, A5, TT
- Škoda Fabia, Octavia, Superb

for engine codes:

ADX, AEA, AEE, AEH, AEX, AFH, AFK, AGP, AGR, AHW, AJM, AKL, ALN, AMF, ANA, ANY, APE, APE, APF, ARM, ATJ, AUA, AWH, CGGA, CGPB  
OEM T30004  
OEM 3415



Audi  
VW  
Seat  
Škoda

Description

Arrester key for crankshaft VAG  
Rep.-Kit

Part no.

**10586L**  
**10586L-REP**

## Arrester key

for crankshaft belt pulleys, for loosening and tightening the central screw for VW 1.6 l

- suitable for VW Bora, Golf, Lupo, New Beetle, Polo
- Seat Ibiza, Cordoba
- for engine codes: ARC, ATN, AUS, AVY, AZD, BCB



Seat  
VW

Part no.

**10584L**





## Crankshaft counterholder



to release and tighten the internal hex and centre bolt when replacing the belt and shaft seal on VAG 4-cylinder engines

VW  
Seat  
Audi

Ideal especially for diesel engines with extremely tight bolts



Part no.  
**10569L**

## Crankshaft counterholder



to release and tighten the internal hex and centre bolt when replacing the belt and shaft seal on VAG 5-cylinder engines. Ideal especially for diesel engines with extremely tight bolts



Part no.  
**10559L**

## Crankshaft arrester



Suitable for:

BMW

- BMW with engine codes: N12, N14, N40, N42, N43, N45, N46, N51, N52, N53, N63

Usable as BMW OE number: 119280 counter-brace.



Part no.  
**10589L**

## BMW Crankshaft tool

BMW

Crankshaft retainer for loosening and tightening the central hexagon bolt when replacing the vibration damper or engine repairs.

Suitable for BMW diesel engines:

M47:

- BMW E46 318d 116PS - 318td 115PS - 318dt 115PS - 318d 115PS - 320d 136PS - 320td 150PS - 320d 150PS
- BMW E90 318d 150PS - 320d 150PS - 320d 163PS
- BMW E91 318d 122PS - 320d 150PS - 320d 163PS
- BMW E39 520d 136PS
- BMW X3 E83 2.0d 150PS

N47:

- BMW E81 120d 163PS
- BMW E61 520d 150PS - 520d 163PS

To use as BMW-OE number:

- 11 6310

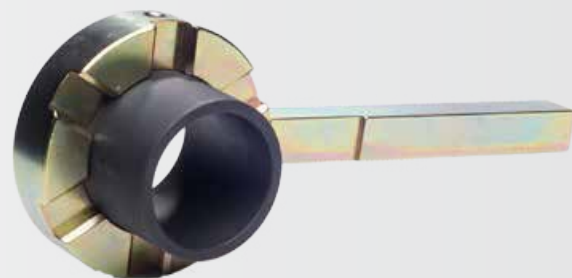

Part no.  
**10568L**

## Flywheel holder

for blocking the flywheel when releasing and tightening the central screws on the vibration absorber (crankshaft belt pulley) in diesel and petrol engines with the following engine codes:

- M47T2, M47TU, M57T2, M57TU, M67, N43, N45, N45T, N46, N46T, N47, N47S, N51, N52, N53, N54, W17

For the following work, e.g. when:

- Exchanging the vibration absorber
- Replacing the crank shaft radial seal ring (on the front)

Suitable for:

- 116i, 118i, 120i, 128i, 130i, 135i, 135is, 118d, 120d, 123d (E81, E82, E87, E88) / 316i, 318i, 318ti, 320i, 320Si, 323i, 325i, 325xi, 328i, 328xi, 330i, 330xi, 335i, 335xi, 318d, 320d, 320td, 325d, 330d, 330xd, 335d (E46, E90, E91, E92, E93) / 520i, 523i, 525i, 525xi, 530i, 530xi, 535i, 535xi, 520d, 525d, 525xd, 530d, 530xd, 535d, (E60, E61) / 630i, 635d (E63, E64) / 730i, 730d, 740d, (E38, E65, E66) / X3-2.0i, X3-2.0d, X3-3.0d, X5-3.0D, X6-3.5D, X6-3.0d, X6-3.5d(E53, E70, E83) / Z4-2.0i, Z4-2.5i, Z4-3.0i (E85, E86) / Mini One, (R50)

Can be used in the similar way to:

- Counter support (complete) BMW OE Nr. 11 8 180
- Connecting holder BMW OE Nr. 11 8 182
- Base plate BMW OE Nr. 11 8 183
- adapter (for E65/M67) BMW OE Nr. 11 8 184
- adapter with an adjusting sleeve (for E46/ M47TU) BMW OE Nr. 11 8 185

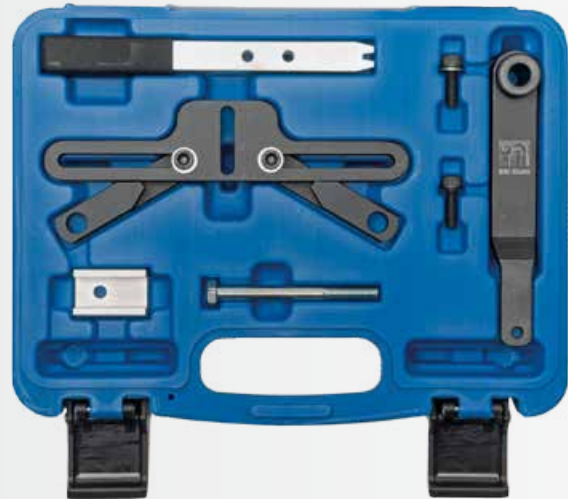

Part no.  
**10588L**



Mini  
BMW



## V-rip belt clamping key set

for Mini One, Cooper, Cooper S (R50, R52, R53) with the engine code W10, W11. For professional mounting and removal of the V-rip belt of the generator.

Can be used similar to:

- Steady (old version) BMW OE Nr. 118390
- Blemish stick (old version) BMW OE Nr. 118280
- Steady (new version) BMW OE Nr. 118410
- Blemish stick (old version) BMW OE Nr. 118470

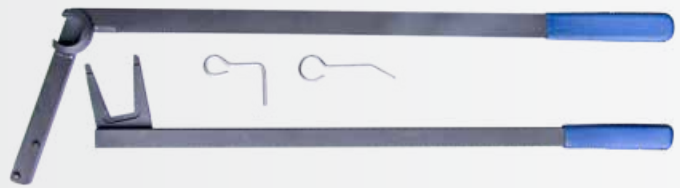

Part no.  
**10591L**



Mini

## Belt pulley key

for fixing all belt pulleys, extra long lever and stable design to prevent damage to the components.

- about Ø 170 mm

For V-rib belts and flat belts



Part no.  
**10573L**



## Belt pulley rotating key

for turning over the engine

- the adjustable roller can be adjusted to each belt pulley size
- e.g. for Audi, BMW, Ford, Mercedes, Opel, Peugeot, Renault, Rover, Volvo, VW and diverse. Japanese manufacturers



Part no.  
**10574L**



Audi  
Volvo  
BMW  
Ford  
Mercedes-Benz  
Opel  
Peugeot  
Renault  
Rover  
VW

ⓘ Do not use for holding the belt pulley in place

Length  
325 mm





## V-rib belt tool set



10 mm (3/8") and 12.5 mm (1/2") drive, makes work possible at spots that are difficult to access, since every angle can be reached by means of XZN tripe square adjustment in combination with the ratchet.

- metrical sockets: 8 - 12 - 13 - 14 - 17 - 18 - 24 mm
- imperial sockets: 3/8" - 1/2" - 5/8"



Description	Part no.
13-piece	10575L

## V-ribbed belt tool set



for the straightforward removal and fitting of new elastic V-ribbed belts (e.g. air-conditioning compressor)  
Also suitable for use with double-belt drives.

Suitable for the following models:

- Audi A3
- BMW 118, 120, 318, 320, 325, 330, 335, 520, 525, 530, 535, 635, 730, X3, X5
- Chrysler Grand Voyager, Voyager
- Citroën C2, C3, C4, Jumper, Relay
- Fiat Albea, Doblo, Ducato, Fiorino, Fiorino Qubo, Linea, Marea, Multipla, Palio, Siena, Stilo, Strada Pick Up
- Ford C-Max, Focus, Focus C-Max, Fusion, Mondeo, Tourneo, Transit
- Iveco Daily
- Lancia Lybra
- Mazda 2, 3, 5, Axela
- Mercedes-Benz Sprinter, Viano, Vito
- Peugeot 206, 207, 307, Boxer
- Seat Altea, Ibiza
- Škoda Octavia, Yeti
- Volvo C30, S40, V50
- VW EOS, Golf, Passat, Polo, Scirocco



VW  
Volvo  
Škoda  
Seat  
Peugeot  
Mercedes-Benz  
Mazda  
Lancia  
Iveco  
Ford  
Fiat  
Citroën  
Chrysler  
BMW  
Audi

ⓘ Since there is no clamping unit, it is not possible to relieve belt tension. This makes the tool almost indispensable for professional removal and fitting work.  
For use on the crankshaft belt pulley

Description	Part no.
11-piece	10587L

## Spanner for tamperproof hardware



for all double-hole nuts from 11 mm gap, with riveted pins. Pin diameter 4,1 mm, e.g.

- for fixing the screw-nut of the angle grinder
- also applicable for fitting and removing the visco fan clutch VW



VW

Length	Part no.
180 mm	S1463

## Spanner for tamperproof hardware set

universally adjustable, with replaceable pin and locking through knurled nut.

- pin diameter 2.5 - 3 - 4 - 5 - 6 - 7 - 8 - 9 mm
- clamping width 102 mm

Can be used as a steady during repairs to gearboxes and differential e.g. Daimler, Ford, Volvo etc.  
Visco fan installation and removal on Audi A4, A6, A8, VW Passat.  
Together with steady SW-Stahl 00120L also suitable for Ford, Opel, Vauxhall and GM.  
As steady for pulling off and mounting vibration dampers during belt pulley repairs.



- Audi
- Ford
- Mercedes-Benz
- Volvo
- VW
- General Motors
- Opel
- Vauxhall

Engine type	Length	Part no.
Universal	250 mm	S1464

## Generator bit set

for mounting freewheel belt pulley. For holding the belt pulley using the enclosed 33-teeth sockets.

- screwdriver bits with hexagon drive:
  - hexagon 8, 10 mm
  - XZN tripe square M8, M10
  - T-profile T40, T50
- 2 firmly mounted bits T50 and M10
- special sockets for Bosch, Valeo, Delco

For universal use on VAG, BMW, Mercedes-Benz, Ford, Renault and others.



- Mercedes-Benz
- Audi
- BMW
- Ford
- Seat
- Škoda
- VW
- Peugeot
- Porsche
- Renault

Description	Part no.
13-piece	05257L

## Alternator mounting set

For mounting the freewheel pulley. Holding the pulley by means of the enclosed 33-tooth inserts and a 31-tooth insert, e.g. For Ford.

- Screwdriving bits with hexagon drive:
  - Hexagonal 8, 10 mm
  - XZN tripe square M8, M10
  - T-profile T40, T50
- 2 fixed bits T50 and M10
- special adapter for almost all vehicle types

E.g. For Mercedes, BMW, Ford, VAG, Fiat, Renault, Porsche, Vauxhall, Toyota (allocation list included)



- Mercedes-Benz
- Ford
- BMW
- Audi
- Peugeot
- Porsche
- Renault
- Seat
- Škoda
- VW
- Fiat
- Toyota
- Vauxhall

assignment list enclosed

Description	Part no.
22-piece	05275L

## Generator multi-purpose key, Spline

for mounting freewheel belt pulley. The belt pulley is held by 33 tooth-insert



- Audi
- BMW
- Ford
- Mercedes-Benz
- Seat
- Škoda
- VW

Description	Profile	Length	Part no.
XZN tripe square 10 for VAG, BMW, Ford, Seat, Mercedes		115 mm	05255L
T-Profil T50 e.g for Mercedes-Benz A-Class		115 mm	05260L



## Cutting off plate cylinder

Universal, for span widths from 32 to 78 mm and clamping depths from 75 mm to 105 mm

Ideal for thin-walled V-belt pulleys, ball bearings, roller bearings, discs, bushings, pinions etc.

Closely fitting parts are loosened safely from their seat by pressing the separating jaws together



Description	Part no.
14-piece	09675L
Cutting blades 30 to 50 mm	10001L
Cutting blades 75 to 105 mm	10002L

## Camshaft / Timing Belt / Chain

### Radiator grille removal aid

used to help push the radiator grille forwards during the replacement of toothed belts or water pump, for example. There is no longer any need to adjust the hood lock and the gap dimension.

e.g. Audi A4, A6, Passat from model year 97



VW  
Audi

Description	Part no.
2-piece	10108L

### Engine adjustment tool set

The complete tool set contains almost all crankshaft and camshaft locking tools as well as comprehensive installation aids such as adjustable tamperproof spanners and radiator grille tools.

- 3-cylinder
- 4-cylinder
- 6-cylinder
- 8-cylinder



Seat  
Audi  
Škoda  
VW

⚠ The camshaft and crankshaft locking tools are not allowed to be used as counterholder!

Description	Engine type	Part no.
VAG - 31-piece	Universal	26057L
Empty case		26057L-KOFFER

### Engine adjustment tool set

for 1,0L VAG engines with motor codes CHYA, CHYB and CPGA.

The set contains the following spare parts:

- crankshaft locking pin (comparable to OEM T10340)
- camshaft clamp (comparable to OEM T10477)
- camshaft sprocket locking tool (comparable to OEM T10476)
- tensioner adjustment tool (comparable to OEM T10499)
- counter-hold tool (comparable to OEM T10475)

Suitable for the following types:

- VW Up / VW Polo (6R)
- Škoda Citigo / Škoda Fabia
- Seat Mii / Seat Ibiza (6J)

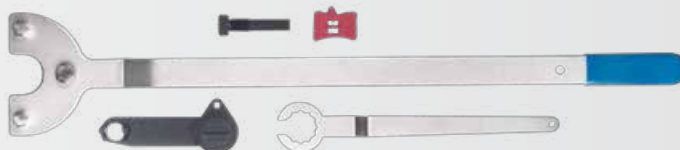

VW  
Škoda  
Seat

Part no.
25999L

## Engine adjustment tool set

for VAG 3-cylinder, 2 and 4-valve technology.  
Contains important tools e.g. for the following work:

- locking the crankshaft
- locking the camshaft
- locking the injection pump shaft
- pulling off the crankshaft belt pulley
- tensioning the toothed belt



VW  
Seat  
Škoda



### Description

VW 3-cylinder - 4-piece

### Engine type

Petrol

### Part no.

26054L

## Engine adjustment tool set

for 1.2l TFSI engines from '08 with timing chain from VAG with engine codes CBZA, CBZB, CBZC.

Contains one camshaft locking device and one crankshaft fixing mandrel. For adjusting the timing e.g. during replacement of the timing chain or during engine repairs.

Suitable for:

- Audi A1, A3
- VW Caddy, Golf, Golf Plus, Jetta, Polo, Touran
- Seat Altea/XL, Ibiza, Leon
- Škoda Fabia II, Octavia II, Roomster, Yeti

Applicable equivalent to VW OE-numbers:

- T10414 camshaft locking device
- T10340 crankshaft fixing device



Audi  
VW  
Škoda  
Seat



### Description

VAG - 4-piece

### Engine type

Petrol

### Part no.

26137L

## Engine adjustment tool set

for 1.4l and 1.6l FSI - TSI - TFSI engines from model year '03 from VAG with the engine codes AXU, BAG, BKG, BLF, BLN, BLP, BMY, BTS, BLG, BWK, CAVA, CAVB, CAVC, CAVD, CAVF, CAXA, CAXC, CDGA. Contains one camshaft locking device, a gauge holder and a locking mandrel.

- Thread M14 x 1,25 mm

Suitable for:

- Audi A3 1.6l
- VW Eos, Golf, Golf Plus, Jetta, Passat, Polo, Scirocco, Tiguan, Touran
- Seat Altea, Ibiza, Leon
- Škoda Fabia II 1.6l, Octavia II, Roomster, Superb



Škoda  
Seat  
VW  
Audi



### Description

4-piece,  
VAG FSI, TSI / TFSI

### Engine type

Petrol

### Part no.

26047L

## Locking tool

for locking both camshafts for VAG petrol engines with 1.4l and 1.6l capacity in Lupo, Polo, Golf, A2, Bora and identical Seat/Škoda model.

With motorcode:

- AFK, AHW, AJV, AKQ, APE, AQQ, ARC, ARR, ATN, AUA, AUB, AUS, AVY, AXP, AZD, BAD, BBY, BBZ, BCA, BCB, BKY, BXW, CGGA



Audi  
Seat  
Škoda  
VW



### Engine type

Petrol

### Part no.

26084L



## Engine adjustment tool set

for VAG 1.8l Turbo and 1.6l FSI engines

- Brace for a crankshaft, usable like OEM 3036
- Camshaft fixing tool, usable like OEM T10171
- Brace for the oil pump wheel sprockets, camshaft and vibration damper, usable like OEM T10172
- Adapter pieces for a brace, usable like OEM T10172
- Holder for a chain tensioner (for installing and dismantling the chain tensioner) usable like OEM T20018 / 3366

Suitable for the following vehicles:

- Audi
  - A3 1.8l Turbo (AGN AGU AJQ APG APP AQA ARX ARY ARZ AUM AUQ) '96-'03
  - A3 1.6l FSI (BAG) '03-'06
  - S3 1.8l Turbo (AMK APY BAM) ab '96
  - A4, A6 1.8l Turbo (ADR AEB AJL AJP ANB APU AVJ AWT) '94-'06
  - Cabriolet 1.8l (ADR) '97-'00
  - TT 1.8l Turbo (AJQ APP APX AUM AUQ BAM) '98-'06
- Volkswagen
  - Beetle 1.8l Turbo (AVC) '99-'06
  - Touran 1.6l FSI (BAG BLP) '03-'07
  - Golf, Bora 1,8l Turbo (AGN AGU AQA ARZ AUM AUQ) '97-'05
  - Passat 1.8l Turbo (ADR AEB ANB APT APU ARG AWT) '96-'05
- Seat
  - Sharan 1.8l Turbo (AJH AWC) '97-'07
  - Ibiza, Cordoba 1.8l Turbo (AQX AYP) '99-'02
  - Leon 1.8l Turbo (AJQ AQN APG APP APT ARY AUQ) '99-'05
  - Toledo Turbo (AQN APG APT ARY AUQ) '99-'05
  - Alhambra 1.8l Turbo (AJW AWC) '97-'07
- Škoda
  - Octavia 1.8l FSI Turbo (AGN AGU ARX ARZ AUM) '96-'05
  - Octavia 1.8l Turbo 20V RS (AUQ) '00-'06
  - Octavia 1.6l FSI (BLF) '04-'07



Audi  
VW  
Seat  
Škoda

### Description

VAG Turbo / FSI - 7-piece

### Engine type

Petrol

### Part no.

26015L

## Special groove nut wrench

Removal and fitting tool for the control valve of the camshaft adjustment on Audi 1.8 L/2.0 I TFSI 4-cylinder engine with timing chain.

Suitable for:

- Audi A3 from '08, A4 ab '08, A5 from '09, Q5 from '08

With engine codes:

- CABA, CABB, CAWB, CDAA, CDHA, CDHB, CDAB, CBFA, CCTA, CCZA, CDNB, CDNC

Can be used equivalent to:

- Removal tool for control valve of camshaft adjuster OE number T10352 and T10352/1

⚠ **Caution left-hand thread!**



Audi

### Description

2-piece

### Part no.

26001L



## Engine adjustment tool set

For VAG 1.8l and 2.0l TSI / TFSI gasoline engines from '08 with control chain.

Fits:

- Audi A3, A4, A5, TT, Q5
- VW Eos, Golf Jetta, Passat, Scirocco, Sharan, Tiguan
- Seat Altea, Exeo, Leon, Toledo
- Škoda Octavia II, Superb II, Yeti

With motor code:

CABA, CABB, CABD, CADA, CAEA, CAEB, CAWA, CAWB, CBFA, CCTA, CCZA, CCZB, CCZC, CDAA, CDAB, CDHA, CDHB, CDNB, CDNC, CDND, CESA, CETA, CFKA, CGYA, CJEB, CJSA, CJSB, BYT, BZB

Can be equivalent to OE numbers:

- crank counter hold tool T10355
- crankshaft thrust piece T10368
- drift for camshaft slide pieces T40196
- locking clips T40267
- camshaft clamp T40271
- assembly tool T10352 und T10352/1



Engine type

Petrol

Part no.

26159L

## Engine adjustment tool set

for 2.0l FSI petrol engines and TFSI (Turbo).

Suitable for (e.g.):

- Audi A3, A4, A6, S3, TT
- VW Golf, Golf Plus, Jetta, EOS, Touran (from '03 - '10), Passat
- Škoda Octavia II
- Engine codes: AWA, AXW, AXX, BGB, BHD, BHZ, BLR, BLX, BLY, BMB, BPG, BPE, BPJ, BPY, BUL, BVX, BVY, BVZ, BWA, BWE, BWJ, BWT, BYD, BYK, BZC, CDLA, CDLB, CDLC, CDLD, CDMA

Can be used equivalent to:

- OE T10252 camshaft locking rod
- OE T10020 tensioner key
- OE T40011 fixing pin
- OE 3366 holding tool for chain adjuster
- OE T10092 clamping screw
- OE T10060/A peg
- OE T10115 blemish stick for chain adjuster



Description

VAG - 7-piece

Engine type

Petrol

Part no.

26022L



VW  
Škoda  
Seat  
Audi



Audi  
VW  
Škoda





## Engine adjustment tool set



Audi

contains important tools e.g. for the following work on Audi with 2.4l / 3.2l FSI V6, V8, V10 petrol engines:

- for locking the cam and crankshaft
- for fixing the chain tensioning unit
- for replacing the timing chain
- for adjusting the timing during engine repairs

Suitable for:

- Audi A4, A6 of the model series B7 and C6
- With engine codes: AUK, BDW

Applicable equivalent to:

- rotary adapter of the crankshaft OE number T40058
- crankshaft fixing device OE number T40069
- fixing pin for chain tensioner OE number T40071
- 2-piece camshaft fixing device OE number T40070



Description	Engine type	Part no.
Audi - 5-piece	Petrol	26133L

## Locking tool set



Audi  
VW

for locking the crankshaft during work on the engine control, e.g. toothed belt or engine.

Can be used with VW/Audi V6 petrol and V6 + V8 2,5TDI and 3,3TDI diesel engines Audi A8.

Motorcode: ABC, AFB, AKE, AKN, AMY, BAU, BCZ, BFC, BDG, BDH



Engine type	Part no.
V engine	26086L

## Engine adjustment tool set



Audi

for 3.0 litre V6 petrol engines with double camshaft, e.g. Audi A4 / A6 / A8 / Cabrio.

Engine code: ASN / AVK / BBJ

Contains important tools for positioning and locking crankshaft and camshaft during toothed belt and engine repairs.

- OEM 3387 / T40011 / T40026 / T40028 / T40030 (2 x)



Description	Engine type	Part no.
Audi - 6-piece	V engine	26011L

## Camshaft retainer tool

for holding the camshaft when loosening and tightening the camshaft gear screw connection.

For the use on popular 1.3 JTD diesel engines, e.g. Citroën, Peugeot, Fiat, Ford and Alfa Romeo.

Motorcodes:

- Alfa Romeo: 199A3.000, 1994B4.000
- Chrysler: 199B1.000
- Fiat: 169A1.000, 169A5.000, 188A8.000, 188A9.000, 199A2.000, 199A3.000, 199A9.000, 199B2.000, 199B4.000, 199B8.000, 223A9.000, 225A2.000, 263A2.000312A8.000, 330A1.000
- Ford: 169A1.000 (FD4)/BAAA/BBBAB
- Lancia: 188A9.000, 199A2.000, 199A3.000, 199A9.000, 199B1.000, 843A2.000
- Opel/Vauxhall: A13DTC, A13DTE, A13DTR, D13A, LN9 (263A2.000), LN9/A13DTC, LSF/A13DTC, LSF/A13DTE, Y13DT, Z13DT, Z13DTE, Z13DTH, Z13DTI, Z13DTJ, Z13DTR

OE reference:

- OE Ford: 303-1475
- OE Fiat: 1 871 008 600
- OE Citroën: 0104-B

Suitable for:

- Alfa Romeo: Mito
- Citroën: Nemo
- Peugeot: Bipper
- Fiat: 500 / 500 C, Doblo / Doblo Cargo, Fiorino, Grande Punto, Idea, Linea, Panda / Panda Classic, Punto / Punto Classic, Punto Evo, Qubo
- Ford: Ka
- Lancia: Musa, Ypsilon
- Suzuki: Ignis, Splash, Swift, Wagon R+
- Vauxhall / Opel: Agila / Agila B, Astra G / Astra H, Combo C / Combo D, Corsa C / Corsa D, Meriva A / Meriva B, Tigra B, Zafira B



Part no.  
**10592L**

## Crankshaft alignment ruler

for VW + Audi

- Motor Code AAA-ABV-AES-AGZ-AMY-AZX

Suitable for:

- 2.3l, 2.8l and 2.9l (VR5 and VR6 engines) equivalent to OE 3268



Description  
**VW + AUDI**

Part no.  
**26012L**

## Camshaft locking tool

tool clamp for fixing the camshaft wheels of V engines with one camshaft per cylinder row. For work on the motor control unit e.g. toothed belt work. The clamp can be moved so that both 4-valve and 5-valve engines can be served using the one tool. This avoids additional costs.

Can be used with:

- Audi A4 (model year '94 -'99) Coupé and Cabriolet (model year '91 - '96), A6, A8, S4 all-wheel drive (model year '95 - '04), Audi 80 (model year '91 - '96)
- VW Passat (model year '96 -'04)
- Engine code: ABC, ACK, AGA, AGB, AJG, ALF, ALG, ALW, AML, AMM, AMX, APR, APS, APZ, AQD, ARE, ARJ, ASM, BDV, BES



ⓘ Replacement for 26087L and 26088L

Description  
**4- + 5-V engines**

Engine type  
**V engine**

Part no.  
**27001L**



Fiat  
Ford  
Opel  
Vauxhall





## Locking tool

for the crankshaft toothed belt sprocket in 1.2l, 1.4l and 1.9l TDI pump-injector engines from VW, Audi, Škoda, Seat and Ford.

- used equivalent to VAG OEM T10050



Ford  
Audi  
Seat  
Škoda  
VW

Description	Engine type	Part no.
3-piece	Pump / nozzle diesel	26080L

## Engine adjustment tool set

contains important tools e.g. for the following work on VAG 1.6L / 2.0L TDI common rail diesel engines.

- for locking the cam and crankshaft
- for removing and fitting the camshaft wheels
- for fixing the balancer shafts
- for changing the toothed belt or for engine repairs

Suitable for:

- VW Golf V, VI, Plus, EOS, Polo V, Jetta V, VI, Scirocco III, Beetle II, Caddy II, Passat B6, B7, CC, Touran II, Tiguan, Sharan II, T5, Amarok
- Audi A1, A3 (8P), A4 (B8), A5, A6, (C6, C7), TT (8J), Q3, Q5
- Škoda Fabia II, Roomster, Praktik, Octavia II, Superb II, Yeti
- Seat Ibiza (6J), Leon III, Exeo, Toledo, Altea, Alhambra II

Engine code:

- CAYB, CAYC, CBAB, CBBB, CBAA, CFFB, CFGB, CAGA, CAHA, CAGB, CAHB, CAGC, FCA, CAAA, CAAB, CAAC, CCHA, CAVA, CBAB, CBDA, CBDD, CBAC, CBDA, CBDC

Applicable equivalent to:

- locking mandrel injection pump wheel OE number T20102 / 3359
- locking mechanism crankshaft OE number T10050
- locking mechanism camshafts (oval toothed wheel) OE number T10100
- clamping roller key 6 mm inner hexagon OE number T10264
- clamping roller key dia. 2.5 mm number T10264
- clamp fixing mandrel OE number T40098
- arrester camshaft wheel OE number T10051
- removal tool camshaft wheel OE number T10052
- locking mechanism balancer shafts OE number T10255



Škoda  
Seat  
VW  
Audi

Description	Engine type	Part no.
VAG - 10-piece	Common-rail diesel	26131L

## Engine adjustment tool set

for VAG 1.6l and 2.0l TDI Common-rail engines from 2012

- for stopping the cam shaft and crankshaft
- for exchanging the toothed belt or in the case of engine repairs

Suitable for:

- VW Golf VII, SV Sportvan, Polo
- Audi A3, A4, A5, A6, Q5, TT
- Škoda Octavia III
- Seat Leon

With engine codes:

- CRKB, CRLB, CRLC, CUNA, CLHA, CRBC, CRBD, CRFA, CRFC, CNHC, CSUA, CSUB, CLHB, CKFC, CRMB, CRVA, CRVC, CLHA, CRKA, CKFC, CRLB, CUSA, CUSB, CUTA, CKFB, CUPA

Can be used equivalent to OE-numbers:

- Crankshaft fixing OE number T10490
- Counterholder high pressure pump gear OE number T10051
- Fixing mandrel clamping element OE number T10060A
- Tensioning roller key 6 mm hexagon socket OE number T10264
- Tensioning roller fixing Ø 2.5 mm OE number T10265
- 2 setting mandrels for a high pressure pump and cam shaft OE number T10492
- Locking mandrel injection pump gear OE number 3359



Audi  
Seat  
Škoda  
VW

Description	Engine type	Part no.
VAG - 9-piece	Common-rail diesel	26169L

## Locking tool

for VAG vehicles with 2.0 l pump-injector engines with oval crankshaft toothed belt sprocket e.g. with engine code: BDK, BJB, BKE, BLB, BMA, BMM, BMP, BMR, BNA, BPW, BRE, BRF, BRC, BUZ, BVE, BXE e.g. Caddy ('06/'05), Touran etc. For locking the crankshaft when changing the toothed belt or carrying out engine repairs

- used equivalent to VAG OEM T10100



Description	Engine type	Part no.
VAG - 3-piece	Pump / nozzle diesel	26092L

## Locking tool

for locking the camshaft on VAG vehicles with conventional TDI technology.

Allows toothed belt replacement without dismantling the intake pipe and valve cover, can be used together with the locking mandrel 26082L.



Description	Engine type	Part no.
VAG	Diesel	26083L

## Engine adjustment tool set

e.g. for the following work:

- testing and for setting the timing
- for replacing the timing chain
- replacing the cylinder head gasket

VW Touareg, Phaeton, Transporter (T5) from model year '03-'09 with 5 and 10 cylinder diesel engine 2,5 TDI pump-injector motorcode: BAC, BLK, BPD, AXD, AXE, BLJ, BNZ, BPC and 4,9 D/TDI pump-injector-motorcode: AYH, BKW, BLE, BWF.

Can be used equivalent to:

- camshaft clamp VW  
OE-Nr. T10193 and T10194
- crankshaft clamp 10 cylinder VW  
OE-Nr. T10195
- clamping device VW  
OE-Nr. T10199 und T10199/1
- guide pin for gear box VW  
OE-Nr. T10200
- crankshaft spanner VW  
OE-Nr. T10225
- crankshaft clamp 5 cylinder VW  
OE-Nr. T10226
- adjusting tool VW  
OE-Nr. T10234



Description	Engine type	Part no.
VW - 13-piece	Diesel	26008L



Audi  
Seat  
Škoda  
VW  
Ford



Audi  
Seat  
Škoda  
VW





## Engine setting tool set



Audi  
VW

contains important tools, e.g. for the following work on VW / Audi 2.7 l and 3.0 l V6 diesel engines.

- To lock the camshaft and crankshaft
- To lock the balance shaft
- To fasten the chain tensioner unit
- To replace the timing chain
- To set the timing during engine repairs

Suitable for:

- VW Touareg, Phaeton
- Audi A4, A5, A6, A8, Q5, Q7
- with Motorcodes: ASB, BKN, BKS, BMK, BMZ, BNG, BPP, BSG, BUG, BUN, CAMA, CAMB, CANA, CANB, CANC, CAND, CAPA, CARA, CARB, CASA, CASB, CASC, CATA, CCMA, CCWA, CCWB, CDYA, CDYB, CDYC, CEXA, CGKA, CGKB

Used equivalent to:

- Adapter to tension the sprocket OEM T40062
- Adapter to correct the camshaft setting T40061
- Swivel adapter for the crankshaft OEM T40049
- Peg for the injector pump OEM 3359 / T20102
- Swivel adapter for the crankshaft OEM T40058
- 2 x camshaft retainers OEM T40060
- Crankshaft peg OEM 3242



Description	Engine type	Part no.
VW, Audi - 10-piece	Diesel	26132L

## Camshaft positioning and assembly tool set



This tool serves for the positioning and installation of the camshafts in the camshaft module. Before the installation of the camshaft module, the positioning and fixing of the camshafts with respect to each other are absolutely necessary. Otherwise the guide bearings in the cylinder head are destroyed and the cylinder head must be renewed.

Necessary in case of 4-cyl. diesel engines (2.0 ltr. Common Rail), 6-cyl. TDi 2.7 ltr. and 3.0 ltr. Common Rail with 4-valve technology and 8-cyl. TDi 4.0 ltr. Common Rail with 4-valve technology.

Suitable for:

- Audi A4 after 2001
- Audi A6 after 2005
- Audi A8 after 2003
- VW Golf/Jetta after 2006
- VW Tiguan after 2008
- VW Touareg after 2003
- VW Phaeton after 2003

Usable equivalent to OEM T40094, T40095 and T40096.

Description	Engine type	Part no.
VW, Audi - 9-piece	Diesel	26154L

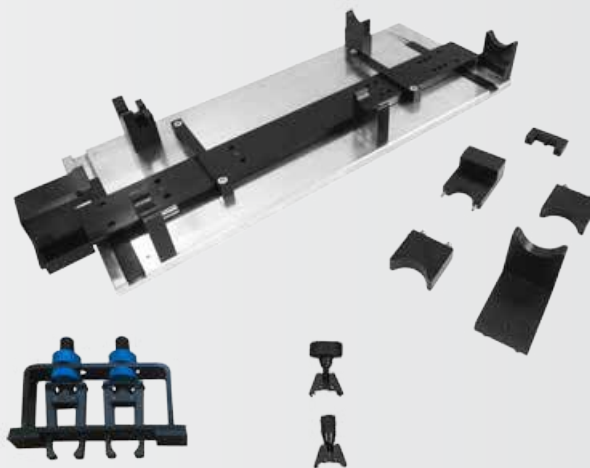

## Camshaft fixing tool

The tool fixes the aligned camshafts in the camshaft module. The tool is absolutely necessary for the professional installation of the camshaft module.

Applicable equivalent to OEM T40095.



Part no.  
26154L-1

## Clamping tool camshaft gears

The tool fixes the gears on the outlet camshaft and holds them in alignment. The tool is absolutely necessary for the professional installation of the camshaft module.

Applicable equivalent to OEM T40096.

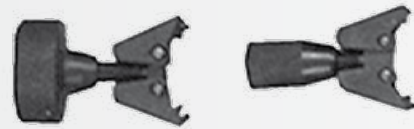

Part no.  
26154L-2

## Crankshaft adjustment tool

Suitable for all 5-cylinder VW diesel engines

- Can be used for adjusting the crankshaft during work on engine timing and as an arrester
- e.g. Touareg from 2003 and Transporter T5 from 2004
- With fixing screw for attachment to the crankshaft
- Can be used equivalent to VAG OEM T10225



Škoda  
Audi  
Seat  
VW

Engine type

V engines

Part no.  
26017L

## Locking tool

for locking the camshafts on VAG 5-cylinder TDI engines e.g. in the LT and T4.

The valve cover does not have to be removed for locking.



Audi  
VW

Engine type

Diesel

Part no.  
26089L

## Toothed-belt tension tester

for setting the pre-tension of the toothed belt.

- For use with all vehicles where the technical data for toothed belt sag are available
- 1 turn of the setting nut corresponds to a piston load of approx. 10 N

Used equivalent to VAG OEM U-10028



Part no.  
10580L

## Retaining plate

for locking the toothed belt clamping jig on TDI pump-injector engines from VW, Audi, Seat and Ford.

- applicable equivalent to OEM T10008

Engine type

Pump / nozzle diesl



Audi  
Ford  
Seat  
VW

Part no.  
26081L

## Peg

- for locking the injector pump wheel on TDI engines without pump-injector as well as
- for positioning the camshaft on pump-injector engines from VW, Audi, Škoda, Seat and Ford

- applicable equivalent to OEM VW 3359 or Seat T20102

Engine type

Diesel



Audi  
Ford  
Seat  
VW  
Škoda

Part no.  
26082L





## Tensioner key

for VAG



VW  
Škoda  
Seat  
Audi

**Length**  
160 mm

**Part no.**  
10550L

## Tensioner key

for VAG



Audi  
Seat  
Škoda  
VW

**Length**  
252 mm

**Part no.**  
10560L

## Tensioner key

5-fold adjustment and handle rotatable by up to 180°. This allows the tool to be used even where bore holes are difficult to reach.

- Especially for toothed belts on 4 and 5-cylinder VAG engines as well as servo pumps on the T4
- Extra low-profile design



Audi  
Škoda  
VW

**Length**  
185 mm

**Part no.**  
10556L

## Tensioner key, Double hexagon

for actuating the automatic tensioning roller when changing the toothed belt on.

- Audi 100 from model year '91, A4, A6 2.5 TDI 5 cylinder
- VW Polo diesel, Lupo from model year '99, LT and T4 2.5 TDI
- identical engines of other manufacturers (Volvo etc.)



Audi  
Volvo  
VW

**Description**  
wrench size 32, double hexagon

**Length**  
170 mm

**Part no.**  
10554L

## Arrester key for crankshaft VAG

for VW 1.4l - 1.6l and 2.0l engines.

- for arresting the crankshaft belt pulley on 4-valve engines with pin diameter 11.5 mm
- for arresting the crankshaft toothed belt wheel on 2-valve engines
- M8 bolt

suitable for:

- VW Bora, Caddy, Golf, Lupo, New Beetle, Polo, Sharan, Touran, Transporter
- Audi A2, A3, A4, A5, TT
- Škoda Fabia, Octavia, Superb

for engine codes:

ADX, AEA, AEE, AEH, AEX, AFH, AFK, AGP, AGR, AHW, AJM, AKL, ALN, AMF, ANA, ANY, APE, APE, APF, ARM, ATJ, AUA, AWH, CGGA, CGPB  
OEM T30004  
OEM 3415

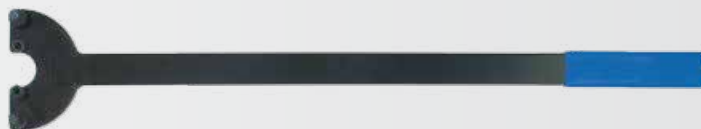

Audi  
VW  
Seat  
Škoda

**Description**  
Arrester key for crankshaft VAG  
Rep.-Kit

**Part no.**  
10586L  
10586L-REP



## Arrester key

for crankshaft belt pulleys, for loosening and tightening the central screw for VW 1.6 l.

- suitable for VW Bora, Golf, Lupo, New Beetle, Polo
- Seat Ibiza, Cordoba
- for engine codes: ARC, ATN, AUS, AVY, AZD, BCB



Seat  
VW



Part no.  
10584L

## Crankshaft counterholder

to release and tighten the internal hex and centre bolt when replacing the belt and shaft seal on VAG 4-cylinder engines.  
Ideal especially for diesel engines with extremely tight bolts.



VW  
Seat  
Audi

Part no.  
10569L

## Crankshaft counterholder

to release and tighten the internal hex and centre bolt when replacing the belt and shaft seal on VAG 5-cylinder engines.  
Ideal especially for diesel engines with extremely tight bolts.



Part no.  
10559L

## Engine adjustment tool set

for locking crankshaft and camshaft on Mercedes-Benz petrol and diesel engines and identical engines in Chrysler PT Cruiser 2.2l CRD, Jeep Grand Cherokee 2.7CRD etc.

- Petrol 1.8l / 2.0l / 2.3l (C & E Class, SLK)
- Diesel 2.0l / 2.2l / 2.7l / 3.3l / 4.0l CDi
- Diesel 2.0l / 2.2l / 2.5l / 2.9l / 3.0l D/DT

Scope of delivery:

- crankshaft locking tool inc. 2 bolts M6x90 (OE 6015890240008932)
- crankshaft locking tool (OE 6025890040008933)
- camshaft locking mandrels (OE 1115890315008929)



Jeep  
Chrysler  
Mercedes-Benz

Description  
Mercedes-Benz - 6-piece

Engine type  
Universal

Part no.  
26044L

## Engine adjustment tool set

for 1.6l und 1.8l gasoline engines with motorcode M271. For adjusting the engine timing, e.g. in the case of changing the toothed belt or motor maintenances.

Suitable for:

- Mercedes-Benz C- CLC- CLK-Class (203, 204, 209) / E-Class (211, 207, 212) / SLK- Class (R171, R172) and Sprinter (W906)

Applicable equivalent to Mercedes-Benz OE-numbers:

- 271 589 01 40 00
- 271 589 00 61 00
- 271 589 00 15 00
- 271 589 00 31 00

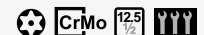

Mercedes-Benz

Description  
Mercedes-Benz - 5-piece

Engine type  
Petrol

Part no.  
26161L



## Engine adjustment tool set



for Mercedes-Benz 1.6l/ 2.0l direct-injection petrol engines with engine code M270 and M274 from '11 to set the engine timing during replacement of the timing chain or repair of the engine.

Suitable for:  
Mercedes-Benz A-Class (176) / B-Class (242, 246) / C-Class (204, 205) / CLA (117) / E-Class (207, 212) / GLA (156) / SLK (172)  
Infiniti Q50

Applicable equivalent to Mercedes-Benz OE no.:

- camshaft locking device 270 589 00 61 00

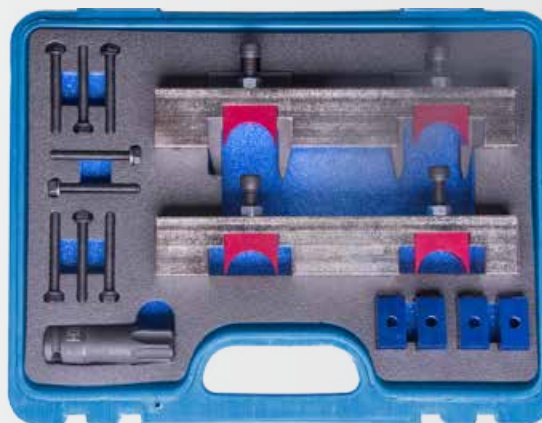

Mercedes-Benz

Description	Engine type	Part no.
Mercedes-Benz - 13-piece	Petrol	26165L

## Engine adjustment tool set



for 1.8l / 2.2l four-cylinder Mercedes-Benz Diesel engines from '08 with timing chain and engine code OM 651. Contains two camshaft locking devices and one crankshaft belt pulley locking device. For setting the engine timing e.g. during replacement of the timing chain or during engine repairs.

Suitable for:

- A180 / A200 / A220 CDI / Blue Efficiency (W176), B180 / B200 / B220 CDI / Blue Efficiency (W246), C180 / C200 / C220 CDI / Blue Efficiency (W/S/C 204), CLA200 / CLA220 (C117), E200 CDI / Blue Efficiency / BlueTec (W/S 212), GLA200 / GLA220 CDI (X156), GLK200 CDI Blue Efficiency (X204), Sprinter 210 / 213 / 216 / 310 / 313 / 316 / 413 / 416 / 510 / 513 / 516 CDI / BlueTec (W906), Vito110 / 113 / 116, Viano 2.0 / 2.2 CDI (W/V639), Vito 114 / 116 CDI, V200 / V220 CDI (W/V447)

Applicable equivalent to Mercedes-Benz OE no.:

- 651589014000 camshaft locking device (2x)
- 651589004000 crankshaft belt pulley locking device



Mercedes-Benz

Description	Engine type	Part no.
Mercedes-Benz - 3-piece	Diesel	26164L

## Timing chain tool



Separating and riveting tool for Mercedes-Benz, to replace single and dual roller chains for engine code M272 or M273.

Applicable equivalent to Mercedes-Benz OE-numbers:

- 272589003900
- 272589006300
- 272589016300



Mercedes-Benz

Description	Engine type	Part no.
Mercedes-Benz - 13-piece	Petrol	26142L

## Engine adjustment tool set

Contains important tools e.g. for the following tasks on petrol engines M40, M43 as well as engines with double camshafts M42, M44, M50, M52, M54, M56:

- installing and removing as well as adjusting the camshaft unit
- checking and setting the camshaft timing
- changing the toothed belt on the M40 engine

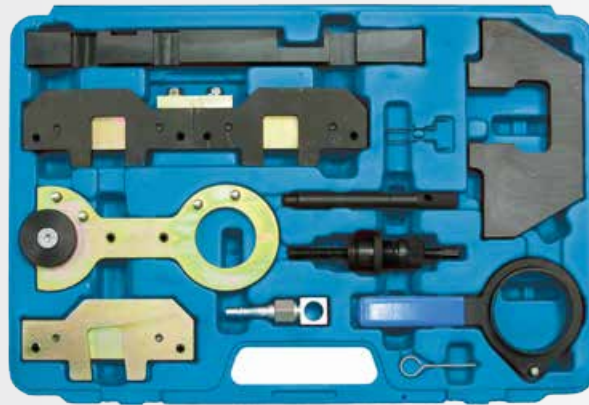

BMW



### Description

BMW petrol engines - 10-piece

### Engine type

Universal

### Part no.

26103L

## Engine adjustment tool set

for the following tasks on diesel engines M41, M51, M47 - M47 TU/T2, M57 TU/T2 2.0l / 3.0l 1998-2008:

- installing and removing the camshafts
- installing and removing the hydraulic chain tensioner
- checking and setting the camshaft timing



BMW

### Description

BMW diesel engines - 13-piece

### Engine type

Universal

### Part no.

26104L

## Engine adjustment tool set

Contains important tools e.g. for the following work on 1.4l / 1.6l petrol engines N12, PSA engines EP3 (8FS), EP6 (5FW), 8FR (EP3), 5FS (EP6), EP6DT (5FX), EP6DTS (5FY).

- setting the timing
- replacing the cylinder head gasket
- replacing the timing chain
- installing and removing the camshafts

Suitable for:

- Mini One Coupé R56 '06-'10, Mini Cooper Coupé R56 '06-'10, Mini Cooper HB R55 '07-'10
- Peugeot 207 / 308 '07-'10, Citroën C3 / C3 DS3 VTI '08-'10, Picasso DS3 / C4 VTI, C4 Picasso

Applicable equivalent to:

- crankshaft fixing kit BMW OE no. 11 9 590
- camshaft fixing kit BMW OE no. 11 9 540
- clamp for timing chain BMW OE no. 11 9 340

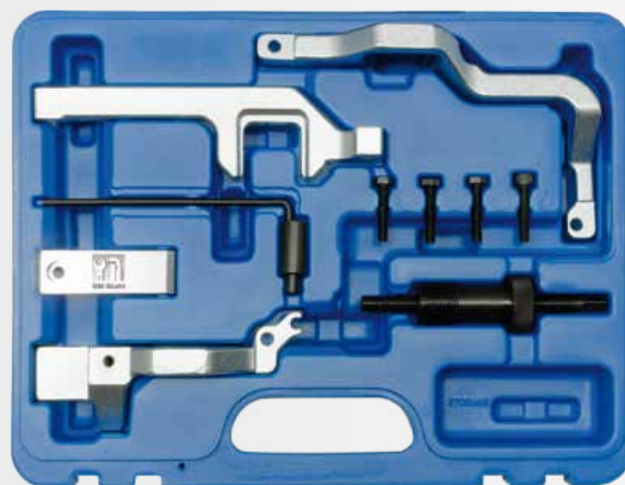

Citroën  
Mini  
Peugeot

### Description

10-piece

### Engine type

Petrol

### Part no.

26108L



## Engine adjustment tool set

for BMW / BMW Mini / PSA

Contains important tools for the following work on 1.4l / 1.6l / 1.8l / 2.0l petrol engines with engine code N13, N18 from '11:

- installing and removing the camshafts
- checking and setting the camshaft timing
- replacing the timing chain
- relacing the cylinder head gasket
- pre-tensioning the chain tensioner

Applicable equivalent to:

- camshaft fixation 117440
- crankshaft fixation 119590
- tensioner for timing chain 119340
- fixing mandrel for flywheel 496709

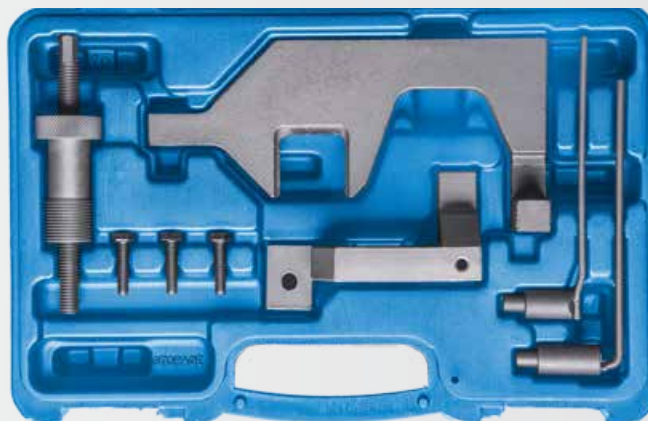

BMW  
Mini

Description	Engine type	Part no.
BMW - 8-piece	Petrol	26163L

## Engine adjustment tool set

Contains important tools e.g. for the following tasks on petrol engines W10, W11, N14

- work on intake and outlet camshaft
- fixing the crankshaft

Suitable for:

- Mini One, Mini Cooper, Cooper S, Cooper S JC, Cooper S JCW of model range R50, R52, R53, R55, R56, R57

Applicable equivalent to:

- engine support BMW OE-Nr. 11 8 370
- camshaft holding tool BMW OE-Nr. 11 8 250
- crankshaft holding tool BMW OE-Nr. 11 9 590
- camshaft clamp BMW OE-Nr. 11 9 550



Mini  
BMW

Description	Engine type	Part no.
BMW Mini - 13-piece	Petrol	26106L

## Engine adjustment tool set

contains important tools e.g. for performing the following tasks on 2.0l petrol engines with engine codes N20 / N26.

- for installing and removing the camshafts
- for checking and setting the camshaft timing
- for replacing the timing chain
- for replacing the cylinder head gasket
- for setting the Vanos adjustment unit
- for pre-tensioning the chain tensioner

Suitable for BMW:

- 125i (F20) from '12, 220i (F22) from '13, 228i (F22) from '14, 320i (F30) from '12, 328i (F30) from '11, 520i (F10) from '11, 528i (F10) from '11, X1 2.0i (E84) from '11, X1 2.8i (E84) from '11, X3 2.0i (F25) from '11, X3 2.8i (F25) from '11, Z4 1.8i (E89) from '13, Z4 2.8i (E89) from '11



BMW

Description	Engine type	Part no.
BMW - 9-piece	Petrol	26145L

## Engine adjustment tool set



BMW



contains important tools for working on 1.6l petrol engines with the engine code N40, N45 e.g.

- for installing and removing the camshafts
- for checking and setting the camshaft timing
- for replacing the timing chain
- for replacing the cylinder head gasket
- for setting the Vanos adjustment unit
- for pre-tensioning the chain tensioner

Suitable for:

- BMW 116i (E81 / E87) engine code: N45, model years: '04-'10, 316i/316ti (E46) engine code: N40, model years: '02-'05, 316i (E90) engine code: N45, model years: '07-'09

Comparable to:

- camshaft fixing kit BMW OE no. 11 7 250 (11 7 251 inlet camshaft, 11 7 252 outlet camshaft, 11 7 253 screw)
- chain tensioner pre-tension BMW OE no. 11 9 340
- camshaft sensing wheels fixing kit BMW OE no. 11 7 260
- crankshaft peg BMW OE no. 11 9 190



**Description**  
BMW - 6-piece

**Engine type**  
Petrol

**Part no.**  
26112L

## Engine adjustment tool set



BMW

Contains important tools e.g. for the following tasks on 4 cylinders petrol engines N42, N46

- installing and removing the camshafts and the variable camshaft unit (double variable camshaft phasing)
- checking and setting the camshaft timing

Suitable for:

- BMW 1-series E81/E87, 3-series E46, E90, E91, X3 E83, Z4 E85, 5er E60, E61



**Description**  
BMW - 26-piece

**Engine type**  
Petrol

**Part no.**  
26105L





## Engine adjustment tool set



BMW

contains important tools e.g. for doing the following tasks on 1.6l / 1.8l / 2.0L petrol engines with the engine code N43:

- for installing and removing the camshafts
- for checking and setting the camshaft timing
- for replacing the timing chain
- for replacing the cylinder head gasket
- for setting the Vanos adjustment unit
- for pre-tensioning the chain tensioner
- for aligning the balancer shafts

Suitable for BMW:

- 116i / 118i / 120i (E81, E87, E88) engine code: N43 from model year '07
- 316i / 318i / 320i (E90, E92, E93) engine code: N43 from model year '07
- 520i (E60, E61) engine code: N43 from model year '06

Applicable equivalent to:

- camshaft fixing kit BMW OE no. 11 8 690
- chain tensioner pre-tension BMW OE no. 11 9 340
- crankshaft peg BMW OE no. 11 5 120
- camshaft sensing wheels fixing kit BMW OE no. 11 8 710
- locking pins oil pump BMW OE no. 2 x 11 3 340
- locking gauge balancer shafts BMW OE no. 11 8 700



Description	Engine type	Part no.
BMW - 7-piece	Petrol	26114L

## Engine adjustment tool set



BMW

contains important tools e.g. for the following tasks on 1.6l, 1.8l, 2.0l, 2.3l, 2.5l diesel engines N47, N47S, N57, N57S:

- for installing and removing the camshafts
- for checking and setting the camshaft timing
- for turning the crankshaft at the vibration damper
- for replacing the cylinder head gasket
- for fixing the high-pressure pump gear wheel in place

Suitable for:

- BMW 116d, 118d, 120d, 123d (E81, E82, E87, E88, F20) / 316d, 318d, 320d, 325d, 330d (E90, E91, E92, E93, F30) / 520d, 525d, 530d, 530d GT, 535d, 535d GT, M550d (E60, E61, F07, F10, F11) / 640d (F12) / 730d, 740d, 750d (F01) / X1-1.8d, 2.0d, 2.3d (E84) / X3-1.8d, 2.0d, 3.0d, 3.5d (E83, F25) / X5-3.0d, 4.0d, M5.0d (E70) / X6-3.0d, 4.0d, M5.0d (E71)

Applicable equivalent to:

- crankshaft locking tool BMW OE Nr. 115320
- camshaft locking tool BMW OE Nr. 118760
- spinning tool on vibration damper BMW OE Nr. 116480
- high-pressure pump removal tool BMW OE Nr. 118740



Description	Engine type	Part no.
BMW - 5-piece	Diesel	26111L

## Crankshaft Holding Tool



BMW

Crankshaft locking bracket for BMW N47 and N57 Diesel engines. Essential for securing the crankshaft when replacing the timing chain.

Passend für N47- und N57-Motoren:

- X1 (E84), X3 (E83, F25), X4 (F26), X5 (E70, F15), X6 (E71, F16)
- Serie 1 (E81/82/87/88, F20/21), Serie 2 (F22), Serie 3 (E90/91/92/93, F30/31/34), Serie 4 (F32/33/36), Serie 5 (E60/61, F10/11, F07), Serie 6 (F12/13, F06), Serie 7 (F01/02/04)

BMW OEM tool: 114320



Part no.
26167L

## BMW Engine adjustment tool set



BMW



Contains important tools e.g. for the following work on 2.5l and 3.0l six-cylinder petrol engines with Valvetronic N51, N52, N52K, N55 or direct injection N53, N54

- installing and removing the camshafts
- replacing the cylinder head gasket
- checking and setting the camshaft timing
- setting or replacing the VANOS adjustment unit

Suitable for:

BMW 125i, 128i, 130i, 135i und 1er M Coupé (E81, E82, E87, E88) / 320si, 323i, 325i, 328i, 330i, 335i, Alpina B3, B3S Bi Turbo (E90, E91, E92, E93, F30) / 523i, 525i, 528i, 530i, 535i, 535GT, (E60, E61, F07, F10, F11) / 630i, 640i, (E63, E64, F06, F12, F13) / 730i, 730Li, 740i, 740Li, (E65, E66, F01) / X1drive25i, X1drive28i, (E84) / X3 2.5i, X3 2.5si, X3 3.0i, X3 3.0si, X3drive28i, X3drive35i (E83, F25) / X5 3.0si, X5drive30i, X5drive35i, (E70) / X6drive35i (E71) / Z4 2.5i, Z4 2.5si, Z4 3.0si, Z4sdrive23i, Z4sdrive30i, Z4sdrive35i, Z4sdrive35si (E85, E86, E89)

Applicable equivalent to:

- flywheel fixing kit BMW OE no. 11 0 300
- camshaft fixing kit BMW OE no. 11 4 280 (gauges 11 4 281m adapter 11 4 282, bracket 11 4 283)
- camshaft sensing wheels fixing kit (N53, N54) BMW OE no. 11 8 520
- camshaft sensing wheels fixing kit (N51, N52, N52K, N53) BMW OE no. 11 4 290



Description	Engine type	Part no.
BMW - 17-piece	Petrol	26100L

## Crankshaft arrester



BMW



Suitable for:

- BMW with engine codes: N12, N14, N40, N42, N43, N45, N46, N51, N52, N53, N63

Usable equivalent to: BMW OE number: 119280 counter-brace.



Part no.  
10589L



## BMW Crankshaft tool

BMW



Crankshaft retainer for loosening and tightening the central hexagon bolt when replacing the vibration damper or engine repairs.

Suitable for BMW diesel engines:

M47:

- BMW E46 318d 116PS - 318td 115PS - 318dt 115PS - 318d 115PS - 320d 136PS - 320td 150PS - 320d 150PS
- BMW E90 318d 150PS - 320d 150PS - 320d 163PS
- BMW E91 318d 122PS - 320d 150PS - 320d 163PS
- BMW E39 520d 136PS
- BMW X3 E83 2.0d 150PS

N47:

- BMW E81 120d 163PS
- BMW E61 520d 150PS - 520d 163PS

To use equivalent to BMW-OE number:

- 11 6310



Part no.  
10568L





## Flywheel holder

for blocking the flywheel when releasing and tightening the central screws on the vibration absorber (crankshaft belt pulley) in diesel and petrol engines with the following engine codes:

- M47T2, M47TU, M57T2, M57TU, M67, N43, N45, N45T, N46, N46T, N47, N47S, N51, N52, N53, N54, W17

For the following work, e.g. when:

- Exchanging the vibration absorber
- Replacing the crank shaft radial seal ring (on the front)

Suitable for:

- 116i, 118i, 120i, 128i, 130i, 135i, 135is, 118d, 120d, 123d (E81, E82, E87, E88) / 316i, 318i, 318ti, 320i, 320Si, 323i, 325i, 325xi, 328i, 328xi, 330i, 330xi, 335i, 335xi, 318d, 320d, 320td, 325d, 330d, 330xd, 335d (E46, E90, E91, E92, E93) / 520i, 523i, 525i, 525xi, 530i, 530xi, 535i, 535xi, 520d, 525d, 525xd, 530d, 530xd, 535d, (E60, E61) / 630i, 635d (E63, E64) / 730i, 730d, 740d, (E38, E65, E66) / X3-2.0i, X3-2.0d, X3-3.0d, X5-3.0D, X6-3.5D, X6-3.0d, X6-3.5d(E53, E70, E83) / Z4-2.0i, Z4-2.5i, Z4-3.0i (E85, E86) / Mini One, (R50)

Can be used equivalent to:

- Counter support (complete) BMW OE no. 11 8 180
- Connecting holder BMW OE no. 11 8 182
- Base plate BMW OE no. 11 8 183
- adapter (for E65/M67) BMW OE no. 11 8 184
- adapter with an adjusting sleeve (for E46/M47TU) BMW OE no. 11 8 185

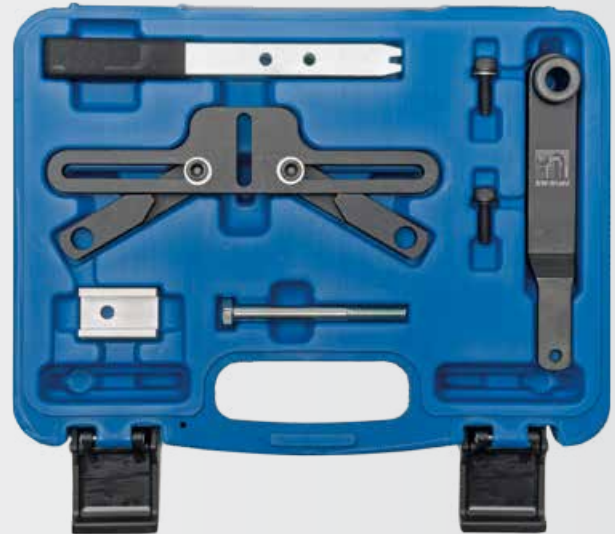

Mini  
BMW

Description	Engine type	Part no.
BMW - 7-piece	Universal	10588L

## Balancer shaft fixing device

Suitable for: BMW models with engine codes N40, N42, N45, N46.  
Applicable equivalent to: BMW OE-Nr. 119330



BMW

Description	Part no.
BMW - N40, N45, N46	26143L

## Balancer shaft fixing device

Fixing gauge for adjusting the oil pump unit's balancer shafts (new version).

Suitable for BMW models with engine codes: N45, N46.

Applicable equivalent to: BMW OE no. 115140.



BMW

Description	Part no.
	26144L

## Engine adjustment tool set

Contains important tools e.g. for the following work:

- locking the flywheel
- locking the crankshaft
- locking the camshaft
- locking the injection pump shaft
- pulling off the crankshaft belt pulley
- tensioning the toothed belt



Opel  
Saab

ⓘ The camshaft and crankshaft locking devices may not be used as a brace for tightening!

Description	Part no.
Opel, Saab - 25-piece	26053L



## Locking tool set

for Opel engines with double camshafts , For locking the crankshaft, camshafts and timing-chain tensioner on

- 3 - cylinder engines  
1.0l 12V with code X10XE / Z10XE / Z10XEP
- 4 - cylinder engines  
1.2l 16V with code X12XE / Z12XE / Z12XEP  
1.4l 16V with code Z14XEL / Z14XEP



Opel



### Description

Opel - 5-piece

### Engine type

Petrol

### Part no.

26021L

## Engine adjustment tool set

for Opel engines 1.0l - 1.2l - 1.4l with a double camshaft for locking the crankshaft, camshaft and camshaft chain tensioner.

Suitable for:

Opel/Vauxhall Agila ('00-'03), Agila B ('08-'10), Adam (from '12), Ampera (from '11), Corsa C (from '00), Corsa D (from '06), Insignia (from '11), Meriva B (from '10), Mokka (from '12), Zafira C Tourer (from '11), Chevrolet Aveo (from '11) with the following engine codes:

A10XEP, A12XEL(LWD/L2Q), A12XER, A14NEL(LUH), A14NET(LUJ), A14XEL(LDD), A14XER(LDD), A14XFL(LUU)

Applicable equivalent to OE-numbers:

- EN-49977-100 locking tool for camshaft sensor wheels
- EN-49977-200 adjustment tool for the intake camshaft
- EN-49978 locking tool for the camshaft sensor wheel
- EN-955-1, KM-955-1 locking pin for the chain tensioner
- EN-955-2, KM-955-2 locking pin for the belt tensioner
- EN-953-A, KM-953-A camshaft setting ruler
- EN-952, KM-952 crankshaft locking bolt



Vauxhall  
Opel  
Chevrolet



### Description

Opel - 7-piece

### Engine type

Petrol

### Part no.

26139L

## Engine adjustment tool set

suitable for 1.6 ecoFLEX diesel engines in the following vehicles:

Opel / Vauxhall: Astra-J, Astra-K, GTC, Insignia-A, Meriva-B, Mokka, Zafira-C Tourer 1.6 CDTi ecoFLEX

Engine codes:

LVL/B16DTH, LVL/B16DTJ, LVL/B16DTN, LVM/B16DTC, LVM/B16DTL, LWQ/B16DTC, LWQ/B16DTE

Used equivalent to the following OEM numbers:

- tension pulley retainer pin EN-50513
- crankshaft retainer tool EN-51140
- camshaft retainer tool EN-51143
- cam wheel retainer tool EN-51188
- V-ribbed belt fixing pin EN-6349 / EN-6130



Opel  
Vauxhall



### Description

Opel - 7-piece

### Engine type

Diesel

### Part no.

26176L



## Engine adjustment tool set

for 1.4l, 1.6l, 1.8l gasoline engines. For adjusting the engine timing, e.g. in the case of changing the toothed belt or motor maintenances.

Suitable for:

Opel (Vauxhall) Astra G ('03-'06), Astra H ('04-'12), Astra J ('09-'13), Corsa D ('07-'13), Insignia ('08-'13), Meriva A ('06-'10), Signum ('06-'08), Vectra C ('06-'08), Zafira B ('05-'13), Zafira C Tourer ('11-'13) Chevrolet Aveo ('08-'13), Cruze ('09-'12), Orlando ('11-'13) Saab 9-5 ('10-'12) Alfa Romeo 159 ('05-'10) Fiat Croma ('06-'11), Stilo ('05-'08)

With motor code:

A16LEL, A16LER, A16LES, A16LET(LLU), A16XER(LDE), A16XNT(LGE), A18XER(2H0), Z16LEL, Z16LER, Z16LET, Z16XE1, Z16XEP, Z16XER, Z16XNT, Z18XER, 939A4.000

Can be used equivalent to OE-numbers:

- camshaft setting plate KM-6628-A, 2 000 012 000
- camshaft sprocket locking tool KM-6340, EN-6340, 2 000 012 100
- timing belt tensioner locking pin KM-6333, EN-6333
- flywheel holding tool KM-6625, EN-6625, 2 000 012 800
- auxiliary belt tensioner locking pin KM-6349/KM-6130, EN-6349
- flywheel holding tool KM-911

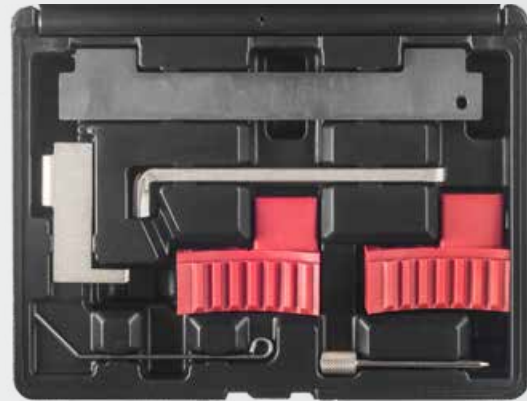

Vauxhall  
Saab  
Opel  
Fiat  
Chevrolet  
Alfa Romeo

### Description

Opel - 7-piece

### Engine type

Petrol

### Part no.

**26160L**

## Engine adjustment tool set

for 2.0l CDI / VCDI Common Rail diesel engines  
For locking the crankshaft and camshaft while adjusting the timing e.g. for toothed belt replacement or engine repairs.

Suitable for:

- Opel (Vauxhall) Antara, Insignia / Chevrolet Captiva, Cruze, Epica, Lacetti, Nubira mit Motorcode Z20DM / Z20DMH (LLW) / Z20S / Z20S1 / RA420

Applicable equivalent to:

- crankshaft fixation OE no. EN-48246
- camshaft fixation OE no. EN-48245



Opel  
Chevrolet

### Description

Opel - 6-piece

### Engine type

Diesel

### Part no.

**26130L**

## Locking tool set

for Opel Ecotec V6 2.5l, 2.6l / SAAB V6 3.0l engines with multivalve technology X25XE, X30XE, Y26SE, Y32SE, B308E, B308I.

The case contains all the necessary tools for blocking the crankshaft and camshaft and thus for setting the TDC.

Contents:

- Crankshaft locking tool
- Camshaft setting gauge
- Retaining tool for toothed belts
- Blocking tool for the right-hand camshaft
- Blocking tool for the left-hand camshaft

Applicable equivalent to:

- OE-No. KM800-1 / KM800-2 / KM800-10 / KM800-20 / KM800-30



Opel  
Saab

### Description

Opel - 7-piece

### Engine type

Diesel and petrol

### Part no.

**26094L**

## Locking tool

for locking double overhead camshafts

- Astra G, Astra H, Corsa C, Corsa D, Insignia, Signum, Meriva 1.6-16V VXR, Zafira A, Zafira B, Vectra C, Tigra B Roadster

- Applicable equivalent to: Opel OE-Nummer KM-6340

Opel 1.6l petrol engines (A16LET / A16XER / Z16LEL / Z16LER / Z16LET / Z16XE, Z16XE1 / Z16XEP / Z16XER)



Vauxhall  
Opel  
Saab



Engine type

Part no.

Petrol

26029L

## Locking tool

for locking the camshafts for Astra, Omega B, Vectra B, Calibra engines.

- Opel OE-Nr. KM-853
- Motorcode: X18XE, C20SEL, X20XEV, X22SE, X22XE, Y22XE, Z22XE



Opel

Description

Engine type

Part no.

1.8l / 2.0l / 2.2l engines

Petrol

26095L

## Locking tool

for locking the camshafts for Opel Tigra B, Sintra, Vectra, Calibra and Omega engines with 1.4l / 1.6l / 1.8l with motorcode Z18XE.

- Applicable equivalent to Opel OE-No. KM-852

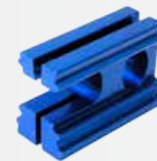

Opel

Description

Engine type

Part no.

1.4l / 1.6l / 1.8l engines

Petrol

26096L

## Locking tool

for locking the camshafts for Opel Sintra, Vectra, Calibra as well as Saab 900 and 9000.

- Opel engines with 2.5l and 3.0l
- Saab engines with 2.5l and 3.0l

For left-hand shafts (green model).



Saab  
Opel

Description

Engine type

Part no.

2,5 + 3,0l with left-hand shafts

Petrol

26097L

## Locking tool

for locking the camshafts for Opel Sintra, Vectra, Calibra as well as Saab 900 and 9000

- Opel engines with 2.5l and 3.0l
- Saab engines with 2.5l and 3.0l

For right-hand shafts (red model).



Saab  
Opel

Description

Engine type

Part no.

2,5 + 3,0l with right-hand shafts

Petrol

26098L





## Engine adjustment tool set



for Ford motors e.g. 1.4l + 1.6l 16V + 1.7l + 1.8l 16V + 2.0l 16V, 1.6l – 1.8l u. 1.9l D/TD/TDCi.

Ford

Contains important tools e.g. for the following work:

- locking the flywheel, crankshaft and injection pump shaft
- tensioning the toothed belt
- positioning the camshaft and pump shaft to the crankshaft

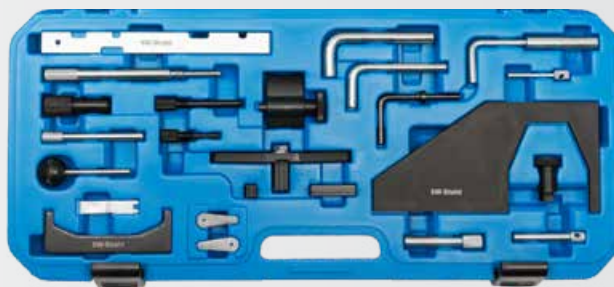

Description	Engine type	Part no.
Ford - 24-piece	Universal	26059L

## Engine adjustment tool set



for working on Ford petrol engines and identical engines, e.g. from Mazda.

Ford  
Mazda

- 1.25 / 1.4 / 1.6 / 1.7 Zetec / 1.8 / RS 1800 / 2.0 Zetec ('91 - '09) motors on Escort, Fiesta, Puma, Focus, C-Max, Fusion, Mondeo, Orion, Tourneo, Cougar, Transit / Mazda 121



Description	Engine type	Part no.
Ford - 4-piece	Petrol	26043L

## Engine setting tool set



for petrol engines.

Mazda  
Ford

Suitable for:

- Ford Mondeo 1.8 l SCI from '03-'07  
Motor Code: CFBA
- Mazda 3 / 5 / 6 / CX-7 with 2.0, 2.3 l engine from '06 - '13, with Motor Code: L3 Turbo, LF (MZR DISI), MZR 2.0 (LF)

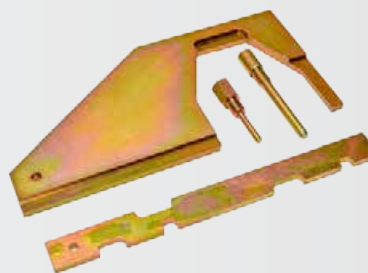

Description	Engine type	Part no.
Ford, Mazda - 4-piece	Petrol	26141L

## Engine setting tool set



for petrol engines 2.0 l SCTI EcoBoost and Ti-VCT direct injection with timing chain.

Ford

Suitable for:

- Ford Galaxy from '10, Mondeo from '10, S-Max from '10, Focus from '11, with Motor Codes: TNWA, TNWB, TPWA, TNBA, TPBA, MGDA, XQDA

Used equivalent to:

- OE number 303-1504 camshaft retainer up to '11
- OE number 303-1565 camshaft retainer up to '11
- OE number 303-1521 aligning tool for crankshaft sensor
- OE number 303-748 crankshaft retainer



Description	Engine type	Part no.
Ford - 7-piece	Petrol	26140L

## Engine adjustment tool set

for replacing the toothed belt in Ford Focus, Focus C-Max 1.6l 16V TI-VCT engines.

- engine code HXDA ('03-'07) and 2.0 TDC engine codes G6DA, G6DB, G6DC ('03-'07)
- holder for camshaft gear
- locking pin for tensioning roller, flywheel and crankshaft
- locking tool for camshaft gear



Ford



### Description

Ford - 5-piece

### Engine type

Petrol

### Part no.

26024L

## Engine adjustment tool set

suitable for 1.0l EcoBoost 3-cylinder petrol engines from 2012 in the following vehicles:

Ford: B-Max, C-Max, Fiesta, Ecosport, Focus, Grand C-Max, Transit Courier, Transit Connect, Tourneo Connect

Engine codes:

M1DA, M1JA, M2DA, M2GA, P4JA, P4JB, SFJA, SFJB, XMJA, XMJB

Used equivalent to the following OEM numbers:

- rig pin 303-732
- tension pulley retainer pin 303-1054
- flywheel retainer tool 303-1602
- sealing ring installation tool 303-1603
- arrester tool 303-1604
- camshaft retainer tool 303-1605
- arrester tool 303-1606
- sealing ring installation tool 303-1636
- peg T10060A



Ford

### Description

Ford - 16-piece

### Engine type

Petrol

### Part no.

26175L

## Engine adjustment tool set

for locking the camshaft, crankshaft and injection pump during the following work:

- setting the timing
- replacing the timing chain
- replacing the cylinder head gasket
- replacing the injection pump

Similar in use to the OEM numbers: crankshaft lock 303 675 (21-234) / pump wheel lock 303-681 (21-240)

For Ford e.g. Mondeo, Transit, etc., from model year 2001 - 2004, with 2.0L and 2.4L 16V TDDi / TDCi diesel engines. Engine code: FMBA/B, D5BA, ABFA, D3FA, F3FA, D2FA, D4FA, F4FA



Ford

### Description

Ford - 11-piece

### Engine type

Diesel

### Part no.

26113L



## Engine adjustment tool set

for professional engine servicing.

Suitable for 2.0 - 2.2 - 2.4 - 3.2 l Ford Duratorq diesel engines in the following vehicles:

- Ford Duratorq (Puma), Mondeo (00-07), Transit (00-11)
- Citroën: Relay (06-11), Jumper II
- Fiat: Ducato (06-11)
- Jaguar: X-Type (01-10)
- Land Rover: Defender (07-11)
- LDV: Convoy (02-06)
- Peugeot: Boxer III (06-11)

Engine codes:

2.0l: ABFA, D3FA, D5BA, D6BA, F3FA, F1FA, FMBA, HJBA, HJBB, HJBC, HJBE, N7BA, N7BB  
 2.2l: QJBA(BG), QJBB, QJBC, QJBD  
 2.2l: 4HM, 4HU, 4HV, P8FA, P22DTE, QVFA, QWFA  
 2.4l: 244DT, D0FA, D2FA, D2FB, D4FA, F4FA, FXFA, H9FA, H9FB, HEFA, HFFA, JXFA, PHFA, ZSD 424  
 3.2l: SAFA

Used equivalent to the following OEM numbers:

- camshaft extractor injection pump 303-249
- camshaft locking tool 303-675
- camshaft radial gasket 303-679A
- adjustment tool for engine covers OE 303-682
- flywheel locking bolt 303-698
- retaining tool for high-pressure pumps 303-1151
- injection pump arrester tool 303-131

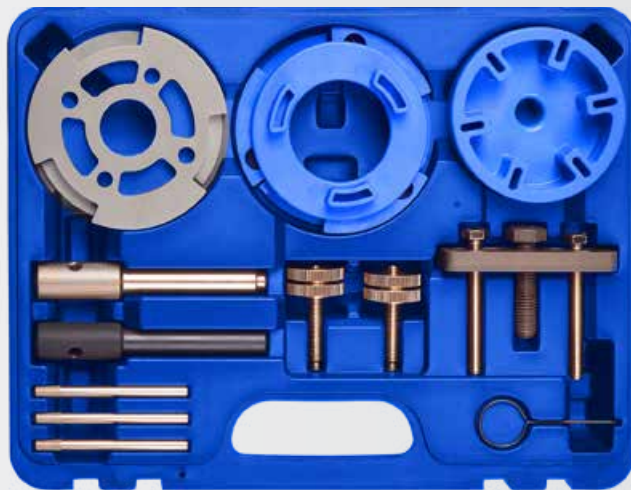

Citroën  
Fiat  
Ford  
Jaguar  
Land Rover

### Description

Ford - 12-piece

### Engine type

Diesel

### Part no.

26173L

## Engine adjustment tool set

for PSA (Peugeot / Citroën)

Contains important tools e.g. for the following jobs:

- locking the flywheel
- locking the crankshaft
- locking the camshaft
- locking the injection pump shaft
- removing the crankshaft pulley
- tensioning the toothed belt

Suitable for petrol engines:

- 1.9 - 1.1 - 1.4 - 1.6 - 1.8 - 1.9 - 2.0
- 1.6 - 1.8 - 2.0 - 2.2 16V (turbo and double camshaft)

Diesel engines:

- 1.4 - 1.5 - 1.7 - 1.8 - 1.9 - 2.1 - 2.5 D / TD / TDI
- 1.4 - 1.6 - 2.0 - 2.2 HDI

Also suitable for identical engines from e.g. Fiat, Ford, Nissan, Renault, Rover, Toyota etc.

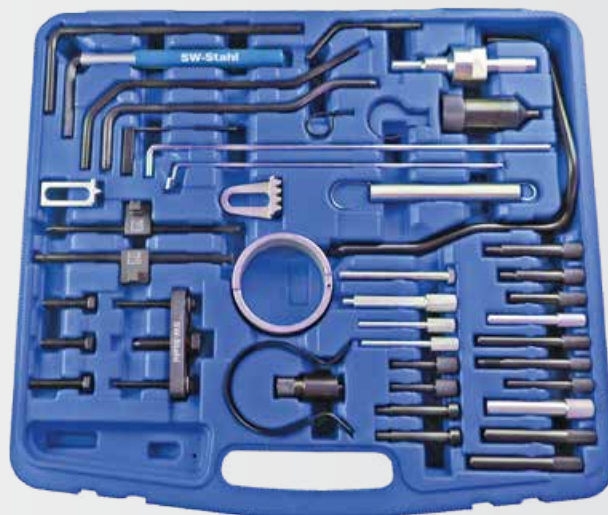

Peugeot  
Citroën

⚠ **The camshaft and crankshaft locking devices must not be used as an arrester for tightening!**

### Description

40-piece

### Engine type

Universal

### Part no.

26138L

## Engine setting tool set

for 2.2 l, 2.3 l, 3.0l JTD engines (identical to PSA).

Also suitable for:

- Citroën Jumper and Peugeot Boxer (22 DT and F30 DT engines)
- Fiat Ducato 2.2l, 2.3l, 3.0l JTD (identical to PSA)
- Fiat 2.2l JTD 4HV, 2.3l JTD F1AE0481D / F1AE0481N, 3.0l JTD
- PSA 22DT 4HV/4HU, F30DT

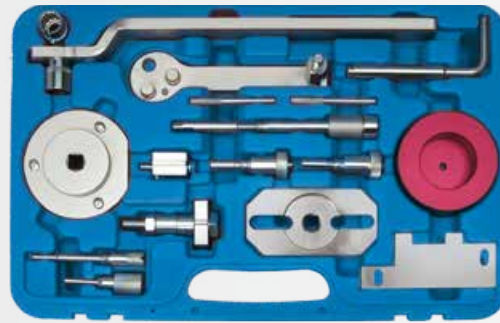

Peugeot  
Citroën  
Fiat



Description  
17-piece

Engine type  
Diesel

Part no.  
26023L

## Locking tool

for locking the flywheel on Citroën, Fiat and Peugeot



Citroën  
Fiat  
Peugeot

Part no.  
26090L

## Engine adjustment tool set

for Renault and different Volvo and Opel petrol and diesel engines, contains important tools e.g. for the following work:

- Locking the flywheel, crankshaft and injection pump shaft
- Pulling off the crankshaft belt pulley
- Tensioning the toothed belt
- Positioning the camshaft and pump shaft to the crankshaft



Renault  
Volvo  
Opel

ⓘ The camshaft and crankshaft locking devices may not be used as a brace for tightening!

Description  
Renault - 17-piece

Engine type  
Universal

Part no.  
26058L

## Engine timing tool set

for Common-Rail engines 1.5l + 1.9l + 2.2l + 2.5l from Renault, Opel, Nissan.  
Contains important tools for positioning and locking crankshaft and camshaft during toothed belt and engine repairs.

With motorcode: K9K, F9Q, G9T, G9U



Opel  
Renault  
Nissan

ⓘ Perfect supplement to set 26058L

Description  
10-piece

Engine type  
Renault Common-Rail

Part no.  
26048L



## Engine adjustment tool set



for diesel engines 2.0l DCI and CDTI.  
Contains important tools e.g. for the following tasks:

Renault  
Opel  
Nissan

- Locking and positioning the crankshaft
- Locking and aligning the camshaft wheels

Suitable for:

- Nissan Primastar from model years '08-'10 (M9R 784)
- Nissan Qashqai from model year '07
- Nissan X-Trail from model years '07-'12 (M9R)
- Opel Vivaro CDTI from model years '06-'09 (M9R 784)
- Renault Espace IV from model years '06-'09 (M9R 740 / 760 / 761)
- Renault Koleos from model years '08-'11 (M9R 830 / 832 / 833)
- Renault Laguna II from model years '05-'07 (M9R 740 / 760)
- Renault Laguna III from model years '07-'09 (M9R 742 / 800 / 805)
- Renault Megane II from model years '06-'09 (M9R 700 / 721 / 724)
- Renault Scenic II from model years '06-'09 (M9R 700 / 721)
- Renault Trafic II (90), (115), from model years '06-'11 (M9R 780 / 784)
- Renault Vel Satis from model year '06 (M9R)



ⓘ **The camshaft and crankshaft locking devices may not be used as a brace for tightening!**

Description	Engine type	Part no.
8-piece	Diesel	26009L

## Camshaft gear removal tool



for Renault 19, 21, Mégane, Scenic, Laguna, Espace, Trafic, Rapid, Clio, Kangoo, Master.  
Also suitable for removing the impeller.

Renault

- Engine codes: F8M, F8Q, J8S, S8U, S9U

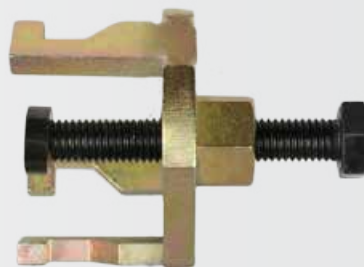

Part no.  
26033L

## Locking tool



for fixing the camshaft wheels when carrying out testing and setting work relating to the valve times for the Renault 1.8l 16V and 2.0l turbo motors.

Renault

Suitable for:

- Renault Laguna II '01 - '09, Mégane II '02 - '09, Scenic II '02 - '09

With engine codes:

- F4P- 720, 722, 760, 770, 771, 772, 773, 774, 775
- F4R- 700, 701, 712, 713, 714, 715, 720, 722, 730, 732, 736, 738, 740, 741, 744, 746, 747, 760, 761, 762, 763, 764, 765, 766, 767, 769, 770, 771, 774, 776, 780, 784, 786, 787, 790, 792, 794, 795, 796, 797, 830

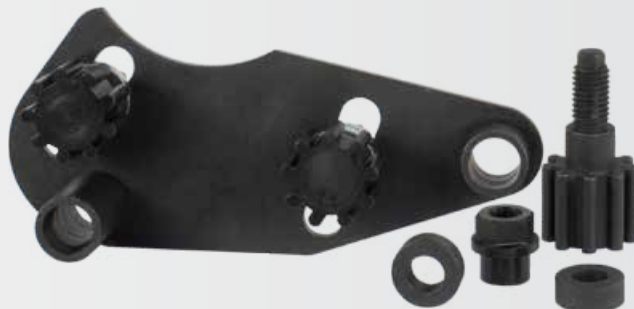

Description	Engine type	Part no.
5-piece	Petrol	26135L



## Engine adjustment tool set

for Fiat + Alfa Romeo

Contains important tools e.g. for the following work:

- locking the flywheel
- locking the crankshaft
- locking the camshaft
- locking the injection pump shaft
- pulling off the crankshaft belt pulley
- tensioning the toothed belt



Fiat  
Alfa Romeo



### Description

Fiat / Alfa - 33-piece

### Engine type

Universal

### Part no.

26052L

## Locking tool set

for locking and aligning the inlet and outlet camshafts e.g. during toothed belt replacement

- Incl. special socket with 12,5 mm (1/2") drive for removing the phase adjuster
- 23 exactly fitting locking tools for inlet and outlet camshaft prevent the camshafts twisting after fitting, and position these correctly for the toothed belt to be fitted.
- Locking tools are marked with numbers and have additional colour coding to prevent mix-ups.
- Exact alignment of the crankshaft is possible when the tools are used together with the TDC setting mandrel and a micrometer (not included in the scope).



Alfa Romeo  
Fiat  
Lancia

### Description

Fiat / Alfa / Lancia - 25-piece

### Engine type

Universal

### Part no.

26016L

## Engine adjustment tool set

contains important tools e.g. for the following work on Fiat, Ford and Lancia mit 1.2l / 1.4l, 8 valve petrol engines:

- for locking the camshaft and crankshaft
- for changing the toothed belt
- for adjusting the timing during engine repairs

Suitable for:

- Fiat New 500 '07 - '12, Doblo/Cargo '05 - '10, Grande Punto '07 - '12, Idea '04 - '12, Linea '07 - '11, Panda EVO2 and Punto EVO '09 - '12
- Ford Ka '09 - '12
- Lancia Ypsilon '06 - '11, Musa '05 - '12

With engine codes:

- Fiat 1.2l Dualogic 169A4.000, 188A4.000 (EVO only), 199A4.000
- Fiat 1.4l Bi-Fuel LPG, Natural Power CNG, 199A7.000, 350A1.000
- Lancia 1.4l Bi-Fuel LPG 350A1.000
- Ford 1.2l Duratec 169A4.000 (FP4)

Applicable like:

- crankshaft locking tool OE number 2.000.004.500 / 303-1480
- camshaft adjustment tool OE number 2.000.004.400 / 303-1479
- camshaft wheel locking tool OE number 2.000.004.200 / 303-1477
- alignment tool for camshaft cover OE number 2.000.004.300 / 303-1478
- toothed belt tensioning tool OE number 1.860.987.000



Ford  
Fiat  
Lancia

### Description

Fiat / Ford / Lancia - 10-piece

### Engine type

Petrol

### Part no.

26134L



## Engine adjustment tool set



for 2.3 JTD Multijet '02-'08 and 3.0 JTD Multijet from '06 from Fiat with motor codes F1AE0481C, F1AE0481D and F1AE0481N. Contains two camshaft marking pins (75 mm), one crankshaft marking pin (105 mm '02-'05), one crankshaft marking pin (175 mm '06-'08) and one camshaft wheel alignment pin (70 mm).

Fiat

E.g. for the following work:

- checking and setting the timing
- changing the toothed belt (2.3 JTD and 2.3 JTD Multijet)
- changing the timing chain (3.0 JTD Multijet)
- replacing the cylinder head gasket

Suitable for:

- Fiat Ducato: 2.3D JTD, 2.3 JTD Multijet 120 and 130, 3.0 JTD Multijet 160

Applicable equivalent to:

- 99360614 camshaft marking pin
- 99360615 crankshaft marking pin ('02-'05)
- 1 860 617 000 camshaft wheel alignment pin
- 2 000 018 200 crankshaft marking pin (from '06)



Description	Engine type	Part no.
Fiat Ducato - 5-piece	Diesel	26136L

## Tension pulley wrench



for belts on Fiat/Alfa Romeo petrol engines

Fiat



Length	Part no.
92 mm	10551L

## Locking tool set



for 4 and 6-cylinder engines from Opel and Ford as well as VAG, Saab, Citroën, Fiat, Peugeot, Rover, Isuzu and MG.

Citroën  
Fiat  
Peugeot  
Audi  
Ford  
Isuzu  
MG  
Opel  
Rover  
Saab  
Seat  
Škoda  
VW

Diesel and petrol engines



Description	Engine type	Part no.
8-piece	Universal	26035L

## Toothed belt measuring tool



measures the tension (Hertz) of all auxiliary and drive belts without contact and due to reduced sensor size can be used where space is tight.

- With microphone measuring head
- No wear, so no maintenance necessary
- Telephonic frequency self-test measuring range: 30 to 520 Hz
- Deviation: +/- 1 Hz from 06 - 100 Hz / 1% at >100 Hz
- LCD display
- 9V battery (approx. 50 h charging time)
- Average usage time max. 30 sec.
- Automatic switch-off after 120 sec.
- Incl. Hertz value catalogue with drive belt tension from European vehicle manufacturers e.g.: Renault, Peugeot, Citroën, Fiat, VW, Opel, etc.



ⓘ Also suitable for motorcycles (especially Ducati)

Part no.  
**10565L**

## Belt pulley remover



e.g. for generators, air-conditioning systems, water pumps

- tension range 40 - 168 mm
- including 10 mm Allen key



Part no.  
**10579L**

## Universal Camshaft Pulley Puller



This tool is suitable for different types of camshaft pulleys with 4, 5 and 6 spokes.



D  
135 mm

Artikel  
**26168L**

## Camshaft wheel puller set



for mounting 5 or 6 spoke camshaft gear wheels. The different hook shapes make almost unlimited use possible

For VW + Audi, 4 and 6-cylinder TDI as well as V6 + V8, A4 + A6 + A8 and Porsche Cayenne

Motorcodes:

- ACK, AEJ, AFB, AGA, AGB, AGE, AHA, AJG, AJK, AKC, AKE, AKN, ALF, ALG, ALW, AML, AMM, AMX, ANK, APC, APR, APS, APZ, AQD, AQF, AQG, AQH, AQJ, ARE, ARJ, ARN, ARS, ARU, ASG, ASJ, ASM, ATQ, ATX, AUW, AVP, AWN, AXQ, AYM, AZA, AZB, AZR, BAU, BBG, BCY, BCZ, BDG, BDH, BDV, BES, BFC, BFL, BFM, BGH, BGJ

Applicable equivalent to OE T40001



Audi  
Porsche  
VW

Description  
5-piece

Engine type  
Universal

Part no.  
**26036L**



## Camshaft fixing tool



Is required for changing toothed belts and all jobs related to engine timing

- Can be used for all DOHC diesel and petrol engines
- Fixing pins made of hardened steel, leading to long service life
- Suitable for universal use thanks to two central arms of different lengths
- Special locking handle for the central arm bolts can be turned to a space-saving position



① Not suitable for OHC engines

Description	Part no.
Double camshafts	26018L

## Camshaft steady



adjustable from 40 - 220 mm  
Thanks to the design length of about 500 mm and the force application connected with this, ideal for loosening the attachment screw on injection pumps and for steadying the toothed belt sprocket on the camshaft etc.

- incl. 4 pairs of inserts Ø 6 - 10, 8 - 11, 10 - 12, 11 - 16 mm, to be used with nearly every camshaft gear wheels



Audi  
Citroën  
Ford  
Mitsubishi  
Opel  
Peugeot  
Renault  
Rover  
Toyota  
Volvo  
VW

Engine type	Length	Part no.
Universal	410 mm	10577L

# Cylinderhead / Valves

## Shaft seal assembly tool set



for installing shaft seals on engines and gearboxes. Suitable for shaft seals with an internal diameter between 32 mm and 38 mm on camshafts, countershafts, and crankshafts.

One of the included brass bushings is inserted over the shaft stub for assembly. The cone-shaped design allows proper insertion of the new shaft seal without damaging the sealing lip. Also suitable for PTFE shaft seals.

Optimised for petrol and diesel engines by Audi, Seat, Škoda, VW, and engines with an identical design, such as by Ford.



Audi  
Ford  
Seat  
Škoda  
VW

Description	Part no.
14-piece	94900L

## Installation and dismantling set for rotary shaft seals



for changing rotary shaft seals on the engine and transmission. With thrust washers in different sizes, pressing tool and wheel puller.

- applicable for crankshafts, camshafts or jack shafts
- enables a rapid and professional installation and dismantling of rotary shaft seals

Universally usable for rotary shaft seals with diameter from 21.5 mm to 64 mm.



Description	Part no.
22-piece	94878L

## Shaft sealing ring pull-out set

Universally fitting for shaft sealing rings with an inner diameter of 25 mm, 27 mm, 32 mm (long), 32 mm (short), 35 mm and 55 mm e.g. in the case of crankshaft sealing rings, camshaft sealing rings and jackshaft sealing rings on VW-Audi, Seat and Škoda engines.

Range of applications: Professional removal of shaft sealing rings on engine shafts such as crankshafts, camshafts and jackshafts, without dismantling the engine.



Description	Part no.
7-piece	94899L

## Double-hook tool

for the removal of sealing rings.

- fast and straightforward removal thanks to 320 mm lever arm
- long service life thanks to lever insert
- coated handle



Part no.  
94875L

## Shaft sealing ring removal set

for the simple removal of sealing rings and lock-rings

- A special hammer with self-cutting screws and two extensions – ideal for removing deep-fitting lock-rings.



① incl. 50 special screws with threaded body for the impact hammer

Description	Part no.
7-piece	94876L
Double hook	94876L-1

## Straight edge

for engines with up to 6 cylinders

- for testing end faces for levelness
- e.g. on cylinder head or engine block
- 2 sides ground



Part no.  
72305L

## Valve gauge

in nickle-plated cover holder



Description	Part no.
0,05 - 1,00 mm / 13 gauges	09102L
0,05 - 1,00 mm / 20 gauges	09103L

## Feeler gauge

21 blades, conical

- 0.10 - 0.12 - 0.14 - 0.16 - 0.18 - 0.20 - 0.22 - 0.24 - 0.26 - 0.28 - 0.30 - 0.32 - 0.34 - 0.36 - 0.38 - 0.40 - 0.42 - 0.44 - 0.46 - 0.48 - 0.50 mm



Description	Part no.
0,10 - 0,50 mm / 21 gauges	09104L



## Outside micrometer



ideal for measuring e.g. valve setting shims, wear on brake discs, camshafts etc.

- scale division 0.01 mm
- gradient per revolution 0.5 mm
- measuring areas hardened
- with clamping lever and ratchet stop
- including hook wrench



**Measuring range**

0 - 25 mm

**Part no.**

**72351L**

## Valve spring fitting set



Complete with compressed air adapters, which enable the valve to be changed in the installed state. Wedges and springs can be inserted and removed by a person.

- compressed air connection for spark plug thread M14x1.25 mm & M16x1.5 mm
- for screwed injection nozzles for diesel engines with M24x2.0 mm
- spring plunger inside Ø 18 mm, outside Ø 22 mm

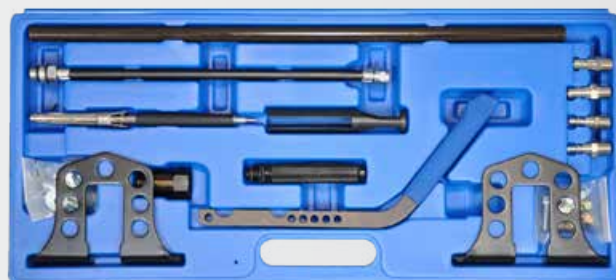

**Description**

13-piece

**Part no.**

**08650L**

## Compressed air adapter



with spark plug threads M14 x 1.25 and M18 x 1.5 for the necessary counterpressure when removing and installing valve tightening wedges with the cylinder head installed.

Suitable for petrol engines with sufficient space in the spark plug bore, e.g. VW, Audi, Ford (except for CVH and multi-valve engines).

With 13 mm hexagon drive and rubber sealing rings

**VW  
Audi  
Ford**



**!** Ideal for the replacement of valve stem seals.

**Length**

140 mm

**Part no.**

**08641L**

## Valve spring tensioning unit



can be used for all applications, ideal for diesels and large volume petrol engines.

- 1 pressure pad A 25 / l 18 mm
- 1 pressure pad A 30 / l 21 mm

Clamping range up to 250 mm



**Engine type**

Universal

**Part no.**

**41260L**

## Valve spring fitting tool set

suitable for almost all passenger car engines, e.g. SV, OHV or OHC engine, usually without removing the cylinder head. Several combinations are possible:

- blank holder straight
- blank holder distorted
- double hook
- hook and U-discs

VW/Audi: double hook with straight blank holder  
 MB/Ford: hook and U-discs with distorted blank holder  
 Opel: double hook with straight or distorted blank holder  
 Porsche: double hook with straight or distorted blank holder  
 for OHC engines hook and U-discs with distorted blank holder



**SW-Stahl**  
 VW  
 Porsche  
 Opel  
 Audi  
 BMW  
 Ford  
 Mercedes-Benz

**Description**  
 9-piece

**Part no.**  
 412100L

## Valve spring tensioner

Universal for OHC engines, with switchable gripper arms and automatic valve stem closure in pre-defined position.

Springs and stem seals are replaced without removing the cylinder head.

ⓘ **Not suitable for very deep valves!**



**Part no.**  
 41265L

## Valve spring tensioner

for petrol engines with 1.0, 1.1, 1.4, 1.6 l displacement in Citroën Berlingo and Xsara, Peugeot 106, 205, 206, 306, 307, 405

- TYU1M+ (CDY, CDZ)
- TU3FJ2 (KFY, KFZ)
- TU3JP (KFW, KFX)
- TU3M/Z (KDX, KDY, KDZ)
- TU5JP (NFZ)
- TU9M (CDY, CDZ)



**SW-Stahl**  
 Citroën  
 Peugeot

**Engine type**  
 Universal

**Part no.**  
 41204L

## Valve sealing ring pliers

For removing the valve stem gaskets, length 250 mm.



**Length**  
 250 mm

**Part no.**  
 08510L

## Valve grinder

with wooden handle



**Description**  
 18 - 22 mm  
 30 - 40 mm

**Part no.**  
 08701L  
 08702L

## Valve seat cutting set

for cylinder heads with hardened valve seats (lead-free)

- 6 double-sided cutters
  - ∅ 28-35 mm, 45 + 75 °
  - ∅ 37-44 mm, 30 + 75 °
  - ∅ 37-46 mm, 45 + 68 °
  - ∅ 44-52 mm, 30 + 75 °
  - ∅ 46-60 mm, 30 + 45 °
  - ∅ 52-65 mm, 60 + 75 °
- 4 infinitely adjustable guides
  - ∅ 6.5-12.5 mm
- 1 T-handle



**ⓘ Suitable for engines unleaded petrol!**

**Description**  
814-piece

**Part no.**  
41217L

## Special bit assortment



Chrome-vanadium, all sockets in optimum length for the special application purpose:

- cylinder head screws
- drive and jointed shafts
- brake calipers



**ⓘ The insert is removeable and fits inside the drawers of all tool chests.**

Description	D	Length	Part no.
8-piece			<b>04900L</b>
12,5 mm (1/2") drive - 7 x 140 mm			<b>04900L-INB7</b>
XZN 8 x 100 mm			<b>04900L-XZN8</b>
Cylinder head as well as jointed and drive shafts for VAG			<b>04900L-XZN8</b>
XZN 10 x 140 mm			<b>04900L-XZN10</b>
Cylinder head VAG, Daimler-Benz, Opel as well as drive shafts for Daimler-Benz	M 10	140 mm	<b>04900L-XZN10</b>
XZN 12 x 140 mm			<b>04900L-XZN12</b>
Cylinder head Daimler-Benz on 6 , 8, 12 Cylinder engine	M 12	140 mm	<b>04900L-XZN12</b>
RIBE 10,3 x 120			<b>05250L</b>
Cylinder head VAG from 11/96			<b>05250L</b>
T 70 x 120			<b>04900L-TX70</b>
Cylinder head screws Ford, Japaner			<b>04900L-TX70</b>
T55 x 140			<b>04900L-TX55</b>
E 12 x 150			<b>04900L-TX55</b>
cCylinder head screws BMW from 1990 without removing the camshaft as well as generator adjustment for Opel vehicles			<b>05682L</b>

## Screwdriver bit, Polydrive



Polydrive 10 x 165 mm  
for cheese-head screws VAG  
(OEM T10070)



**Audi  
Seat  
Škoda  
VW**

**Description**  
Polydrive M 10 x 165 mm

**Part no.**  
**05252L**



## Screwdriver bit, XZN tripe square, Spline

e.g. for cylinder head screws Mercedes-Benz M400, M420, M500 engines  
(cf. OEM 422589010900)



Mercedes-Benz



### Description

XZN tripe square M17 x 60 mm  
for cylinder head screws MB

### Part no.

05253L

## Socket inserts, E Profile, Extra long

for E-profile screws, extra thin-walled and 150 mm long,

- E10 - E12 - E14 - E16 - E18 - E20

E10 e.g. For door hinge bolts on sides and levers of Mercedes-Benz Sprinter and identical LT to '05

E12 e.g. For cylinder head bolts BMW 90 without removing the camshaft as well as adjustment of the engine settings for Vauxhall /Opel vehicles, MAN valve covers

E14 e.g. For drive shafts Mercedes-Benz S-Class, cylinder head Vauxhal / Opel, Audi V6 as Audi 80 with ABS, BMW rear axle bearing unit

E16 e.g. For cylinder head bolts Mercedes-Benz A-Class at 1.4l and 1.7l Diesel

E18 e.g. For the brake caliper fitting on MAN commercial vehicles

E20 e.g. For the cylinder head bolts on MAN commercial vehicles

ⓘ E12 loosens BMW cylinder head screws without removal of the camshaft



BMW

Mercedes-Benz

VW

MAN

Audi

Opel



### Description

6-piece,  
E10-E12-E14-E16-E18-E20

### Profile



### Length

150 mm

### Part no.

05685L

## IMPACT bit, Double hexagon

for cylinder head bolts on trucks



Mercedes-Benz LKW



### Description

fitting for MB 400, 420, 500  
fitting for MB 300, 400, 900

### Profile



### Size

17 mm  
19 mm

### Length

110 mm  
110 mm

### Part no.

38005L  
38007L

## Seal scraper set

stainless, handle lengths each 115 mm

- 100 x 31 mm, thickness 1.1 mm
- 100 x 31 mm, thickness 2.4 mm
- 50 x 20 mm, thickness 1.1 mm
- 50 x 20 mm, thickness 2.4 mm



### Description

4-piece

### Part no.

94840L

## Quality scraper set

with plastic handle,  
Blade width 23 mm, length 240 mm



### Description

2-piece  
Sticker scraper  
Seal scraper

### Part no.

94820L  
94810SB  
94815SB

## Quality scraper



with plastic handle,  
Blade width 23 mm, length 240 mm



Description  
Seal scraper

Part no.  
94815L

## Professional scraper



stainless, with extra sharp blade, ideal for window  
adhesive



Description  
Blade width: 30 mm

Part no.  
94825SB

## Scraper and hook set



hardened,

- scraper 275 mm
- scraper 215 mm
- hook 90°
- parting awl
- hook 45°



Description  
5-piece

Part no.  
94880L

## Scraper set



with 40 mm wide, exchangeable blades

- used for all applications
- due to its extra small design, can also be used in hard to reach places



Description  
2-piece

Part no.  
90603SB

# Engineblock / Piston

## VW/Audi fitting tool



For the professional and damage-free installation of  
sealing flanges with pulse generator wheel in the  
area of the crankshaft.

The exact positioning of the pulse generator wheel  
on the crankshaft is prerequisite for an exact  
transmitter signal and with that fault-free engine  
running.

Without this tool, a damage-free installation of the  
sealing flange is not possible.

This tool combines two tools in one, since the  
positioning of the pulse generator wheel is variable  
by means of a replaceable fixing pin.

In this way you can replace the VW tools T10134  
and T10017 with one tool.



Part no.  
94012L

## Sealing ring fitting set

Specially for the front crankshaft radial seal on BMW engines:

- N40
- N42
- N43
- N45 until 05/2006
- N45T until 05/2006
- N46 until 05/2006
- N51
- N52
- N52K
- N53
- N54

To be used equivalent to BMW OE number:

- 11 9 220 removal tool
- 11 9 230 fitting tool

- ⓘ **Caution: Do not loosen the central bolt on the crankshaft, align the sealing ring grooves centrally to the housing joint during insertion! The grooves must be filled with sealant following fitting!**



BMW



**Description**  
4-piece

**Part no.**  
94877L

## Installation and dismantling set for rotary shaft seals

for changing rotary shaft seals on the engine and transmission. With thrust washers in different sizes, pressing tool and wheel puller.

- applicable for crankshafts, camshafts or jackshafts
- enables a rapid and professional installation and dismantling of rotary shaft seals

Universally usable for rotary shaft seals with diameter from 21.5 mm to 64 mm.



**Description**  
22-piece

**Part no.**  
94878L

## Shaft sealing ring pull-out set

Universally fitting for shaft sealing rings with an inner diameter of 25 mm, 27 mm, 32 mm (long), 32 mm (short), 35 mm and 55 mm e.g. in the case of crankshaft sealing rings, camshaft sealing rings and jackshaft sealing rings on VW-Audi, Seat and Škoda engines.

Range of applications: Professional removal of shaft sealing rings on engine shafts such as crankshafts, camshafts and jackshafts, without dismantling the engine.



**Description**  
7-piece

**Part no.**  
94899L

## Shaft sealing ring removal set

for the simple removal of sealing rings and lock-rings

- A special hammer with self-cutting screws and two extensions – ideal for removing deep-fitting lock-rings.



- ⓘ **incl. 50 special screws with threaded body for the impact hammer**

**Description**  
7-piece  
Double hook

**Part no.**  
94876L  
94876L-1



## Double-hook tool

YYY

for the removal of sealing rings.

- fast and straightforward removal thanks to 320 mm lever arm
- long service life thanks to lever insert
- coated handle



Part no.  
94875L

## Cylinder honing tool

YYY

for use in electric drills, with 28 mm honing segments.

No cuts in the cylinder thanks to adjustable pressure

① Complete with segments in normal grade



### Description

### Part no.

2-arms, for diameter 19 - 50 mm	41100L
3-arms, for diameter 32 - 90 mm	41101L
3-arms, for diameter 51 - 178 mm	41102L

## Honing segments

YYY

with attachment pin



### Description

### Part no.

for 41102L - normal grade - 3 pieces - 100x10 mm	41113L
for 41100L - normal grade - 2 pieces - 28x4 mm	41116L
for 41100L - fine grade - 3 pieces - 28x4 mm	41117L
for 41101L - normal grade - 3 pieces - 50x5 mm	41118L
for 41102L - fine grade - 3 pieces - 100x10 mm	41114L
for 41102L - coarse grade - 3 pieces - 100x10 mm	41115L
for 41101L - fine grade - 3 pieces - 50x5 mm	41119L

## Clamping strap

YYY

40 - 80 mm



### Description

### Part no.

40 - 80 mm, 1 clamping strap 50 x 80 mm	41221L
53 - 125 mm, 2 clamping strap 75 x 125	41222L
53 - 175 mm, 2 clamping strap 75 x 175 mm	41223L

## Seal scraper set

YYY

stainless, handle lengths each 115 mm

- 100 x 31 mm, thickness 1.1 mm
- 100 x 31 mm, thickness 2.4 mm
- 50 x 20 mm, thickness 1.1 mm
- 50 x 20 mm, thickness 2.4 mm



### Description

### Part no.

4-piece	94840L
---------	--------

## Quality scraper set

with plastic handle,  
Blade width 23 mm, length 240 mm



Description	Part no.
2-piece	94820L
Sticker scraper	94810SB
Seal scraper	94815SB

## Quality scraper

with plastic handle,  
Blade width 23 mm, length 240 mm



Description	Part no.
Seal scraper	94815L

## Professional scraper

stainless, with extra sharp blade, ideal for  
window adhesive.



Description	Part no.
Blade width: 30 mm	94825SB

## Scraper and hook set

hardened,

- scraper 275 mm
- scraper 215 mm
- hook 90°
- parting awl
- hook 45°



Description	Part no.
5-piece	94880L

## Scraper set

with 40 mm wide, exchangeable blades.

- used for all applications
- due to its extra small design, can also be used in hard to reach places



Description	Part no.
2-piece	90603SB





## All-in-one tool

for exchanging the silent bearing (double bearing) in the engine cradle.

Suitable for: Audi A3 (8P1) from '03, TT (8J3, 8J9) from '06 - '10, Seat Altea (5P5, 5P8) from '04, Leon (1P1) from '05, Toledo III (5P2) from '04 - '09, Škoda Octavia (1Z3, 1Z5) from '04 - '10, VW Caddy III (2KA, 2KB, 2KH, 2KJ, 2CA, 2CB, 2CH, 2CJ) from '04 - '10, EOS (1F7, 1F8) from '06 / Golf Plus, V, VI (5M1, 521, 1K1, 1K5, 5K1, AJ5) from '03 - '09, Jetta III (1K2) from '05 - '10, Touran (1T1, 1T2, 1T3) from '03, Passat (3C2, 3C5, 362, 365) from '05 - '10, Scirocco (137) from '08, Tiguan (5N) from '07.

ⓘ Suitable only for carrier made of aluminium.



VW  
Škoda  
Seat  
Audi

Description  
12-piece

Part no.  
302501L

## Complete tool

For changing the silent bearing (double bearing) in the motor carrier with hydraulic cylinder.

Fits:

- Audi A3 (8P1) from '03, TT (8J3, 8J9) from '06 - '10
- Seat Altea (5P5, 5P8) from '04, Leon (1P1) from '05, Toledo III (5P2) from '04 - '09
- Škoda Octavia (1Z3, 1Z5) from '04 - '10
- VW Caddy III (2K, 2KB, 2KH, 2KJ, 2CA, 2CB, 2CH, 2CJ) from '04 - '10, EOS (1F7, 1F8) from '06, GolfPlus, V, VI (5M1, 521, 1K1, 1C5, 5K1, AJ5) from '03 - '09, Jetta III (1K2) from '05 - '10, Touran (1T1, 1T2, 1T3) from '03, Passat (3C2, 3C5, 362, 365) from '05 - '10, Scirocco (137) from '08, Tiguan (5N) from '07

ⓘ hydraulic



VW  
Škoda  
Seat  
Audi

Description  
13-piece

Part no.  
302500L

# Fuel System

## Diesel bleeder set with adapters

This set is used to designed to bleed diesel systems, for instance after replacing the filters. To do this, the vehicle adapter is connected in series with the pump between the diesel filter and the injection pump. The transparent hoses enable monitoring of successful bleeding.

Universal fit for Ford, Peugeot, Citroën, Opel, Fiat, Rover, Land Rover, Renault, etc.

- to bleed diesel fuel systems
- the vehicle adapter ensures a direct connection to the vehicle
- transparent hoses for convenient monitoring
- quick and easy to handle
- universally compatible



Description  
14-piece

Part no.  
24037L

## Diesel bleeder pump

for the simple manual bleeding of the fuel system, with bayonet closure  
for the fuel lines e.g. for:

- fuel filter replacement
- replacement of the injection pump (VP44)
- when fuel tank has been completely emptied

Suitable for

- Opel 2.0l / 2.2l Ecotec diesel engines

With engine codes:

- X20DTL, X20DTH, X22DTH



**Engine type**

Diesel

**Part no.**

**24006L**



Opel



## Fuel injection pump tool

for dismantling and assembling the pump shaft on BMW Common-Rail diesel engines M47, M47TU, M57, M57TU

- 7-Series '94 - '01 (E38)
- 5-Series '95 - '03 (E39)
- 5-Series from model year '03 (E60) + Touring (E61)
- 3-Series '98 - '07 (E46)
- X5 '99 - '06 (E53)



**Description**

2-piece

**Part no.**

**26034L**



BMW

## High-pressure pump pull-off device

to pull off the sprocket on BMW N47, N47S, N57, N57S:

Suitable for:

BMW 116d, 118d, 120d, 123d (E81, E82, E87, E88, F20) /  
316d, 318d, 320d, 325d, 330d (E90, E91, E92, E93, F30) /  
520d, 525d, 530d, 530d GT, 535d, 535d GT, M550d (E60, E61,  
F07, F10, F11) / 640d (F12) / 730d, 740d, 750d (F01) /  
X1-1.8d, 2.0d, 2.3d (E84) / X3-1.8d, 2.0d, 3.0d, 3.5d (E83,  
F25) / X5-3.0d, 4.0d, M5.0d (E70) / X6-3.0d, 4.0d, M5.0d (E71)

Used equivalent to:

pull-off device BMW OE no. 118740 (incl. pull-off sleeve BMW  
OE no. 118741 and hey adapter BMW OE no. 118742)



**Part no.**

**26007L**



BMW



## Diesel special tool set

for testing and setting the engine control and start of  
delivery on injection pumps.

Setting values and operating instructions included.

- Suitable for Bosch EP/VE, Rotory, Kikki, Nippon,  
Lucas, CAV, Roto
- Depth gauge 0 - 5 mm



📌 Turnable dial gauge holder included!

**Description**

Complete Set

**Part no.**

**26060L**



Citroën  
Fiat  
Opel  
Peugeot  
Renault  
Rover  
VW  
Volvo  
Audi





## Setting tool for injection pumps



for setting the start of delivery with Bosch and CAV pumps

Opel  
Volvo  
Renault  
Mitsubishi

- for 1.9 l Renault diesel direction injection F8Q and F9Q
- suitable for example for Renault Clio, Laguna, Megane, Scenic, Express/ Extra, R19, Kangoo, Opel Movano, Arena, Mitsubishi Carisma from '97, Volvo S40 / V40

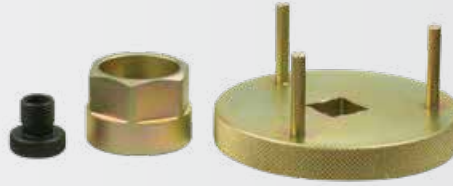

Description

3-piece

Part no.

26025L

## Diesel pump adjusting tool



for diesel engines F9Q on Opel, Renault and Nissan vehicles.

Opel  
Renault  
Nissan

- holding tool for high pressure pump and timing belt pulley
- no timing belt removal needed
- enables precise pump gear fixation
- no readjust needed
- cost and time saving as a result of least-effort



Part no.

26013L

## Fuel Hose Clip Loosening Pliers



for removal and replacement of hose clips connections on in-line fuel filters, e.g. for VW, Audi Fiat, Mercedes-Benz, Opel. With the pliers, the locking can be pushed forward (lock) and backwards (unlock).

Opel  
Audi  
Fiat  
Mercedes-Benz  
General Motors  
VW



Part no.

61708L

## Fuel line detaching pliers



For loosening plug-in connectors with snap-in pins.

Alfa Romeo  
Audi  
Fiat  
Lancia  
Volvo  
VW

- ideal for changing fuel filters
- 90° angled – therefore well suited for tight working conditions
- e.g. for Alfa, Audi, Fiat, Lancia, Volvo, VW etc.



Length

210 mm

Part no.

61718L



## Pliers set

for loosening fuel line connectors on VAG, Fiat, Ford, Opel, Peugeot, Renault and Citroën.



Audi  
Citroën  
Fiat  
Ford  
Opel  
Peugeot  
Renault  
Seat  
Škoda  
VW



**Description**  
3-piece

**Part no.**  
61715L

## CLIC hose clamping pliers

- with rotatable and angled jaws
- for loosening and closing the CLIC and CLIC-R clamps on fuel lines, drive shafts, etc.
- length 190 mm



Audi  
Citroën  
Fiat  
Mercedes-Benz  
Opel  
Peugeot  
Renault  
Seat  
Škoda  
VW



**Length**  
190 mm

**Part no.**  
45000L

## Spring clip pliers

with hardened jaws  
For fitting and removing small spring clips with three ends e.g. on fuel and tank bleeding pipes on Audi, VW, Seat, Škoda vehicles etc.



Audi  
Seat  
Škoda  
VW



**Description**

Clamping range up to 28 mm

**Length**

192 mm

**Part no.**

45001L

## Band-type clamp pliers

for self-clamping spring clamps from 18 – 54 mm on fuel and coolant hoses.

- with bowden cable, suitable for all installation spots which are difficult to access
- safe hold thanks to lever locking

e.g. for:

- Alfa, Audi, Citroën, Fiat, Ford, Hyundai, Lancia, MAN, Mercedes-Benz, Mini (BMW), Opel, Peugeot, Porsche, Renault, Seat, Toyota, VW, Volvo, etc.



Alfa Romeo  
Audi  
Citroën  
Fiat  
Ford  
Hyundai  
Lancia  
MAN  
Mercedes-Benz  
Mini  
Opel  
Peugeot  
Porsche  
Renault  
Seat  
Toyota  
Volvo  
VW



**Description**

Pliers with Bowden cables  
Replacement Bowden cables

**Length**

630 mm  
630 mm

**Part no.**

61777L  
61777L-1



## Band-type clamp pliers



with bowden cables for flat and normal clamps, patented, suitable for all installation spots. Clamps can no longer slip thanks to the special seats.

With new clamp systems, only the bowden cable has to be replaced, the expensive purchase of new pliers is no longer necessary

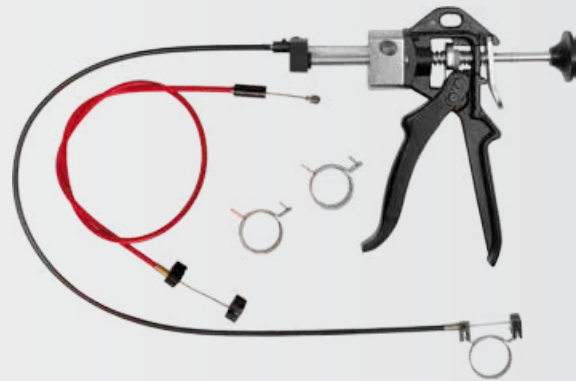

① infinitely adjustable

Description	Part no.
Pliers with Bowden cables	61771L
Standard cable for normal clamps (black)	61773L
Standard cable for flat clamps (red)	61774L
Replacement cable for MOA clamps (blue) e.g. on petrol hoses and gastank ventilaton of VAG vehicles	61776L

## Hose clamp tool, Hexagonal



Flexible, with encapsulated shaft for protection from humidity, dirt and rust.



Profile	D	Length	Part no.
●	6 mm	260 mm	02076L
●	7 mm	260 mm	02077L
●	8 mm	260 mm	02078L

## Ear hose clamp assortment

the assortment contains the following hose clamp types:

- 20 x 5.8 - 7.0mm
- 20 x 7.3 - 9.0 mm
- 20 x 8.8 - 10.5 mm
- 20 x 10.8 - 13.3 mm
- 20 x 12.0 - 14.5 mm
- 20 x 12.3 - 14.8 mm
- 20 x 14.5 - 17.0mm
- 15 x 16.0 - 19.2 mm
- 15 x 17.8 - 21.0 mm



Description	Part no.
170-piece	S8038

## Hose clamp set



3 m endless strap (8 mm wide), can be worked into clamps of any length, with 8 clamping closures

- Stainless



Description	Part no.
9-piece	61742L

## Fuel transmitter key

for loosening and tightening the plastic ring on the fuel transmitter

- for universal use
- adjustable from 75 - 160 mm



Part no.  
61714L

## Line connector loosening clip set

for quick-release couplings on air-conditioning systems and fuel lines with line diameters 1/4", 5/16", 3/8", 1/2", 5/8", 3/4", 7/8"



Daihatsu  
Honda  
Mitsubishi  
Nissan  
Scania LKW  
Volvo

Description  
7-piece

Part no.  
61716L

## Line connector loosening set

for opening line couplings on air-conditioning systems, fuel, air and oil lines with diameter 5/16", 3/8", 1/2", 5/8", 3/4", 7/8".

Universal range - suitable for all standard vehicles



Description  
22-piece

Part no.  
61717L

## Sealing stopper set

prevents liquids escaping e.g. from brake, fuel and power steering lines and prevents soiling entering air-conditioning systems.

Contains:

- two sealing clips for (banjo) hollow bolts and pipe connections
- three sealing plugs for inner diameter 5-6.3-8 mm

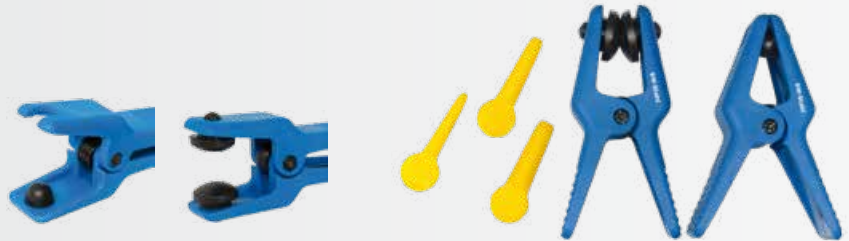

Description  
5-piece

Part no.  
61706L

## Sealing stopper set

prevents liquids escaping e.g. for brake fluid, oil and fuel etc. and prevents soiling entering air-conditioning systems.

Suitable for (banjo) hollow bolts and pipe connections with an inner diameter of 8-10-13 mm.



Description  
8-piece

Part no.  
61707L



## Sealing stopper set



prevents liquids escaping e.g. for brake fluid, oil and fuel etc. and prevents soiling entering air-conditioning systems.

Suitable for (banjo) hollow bolts and pipe connections with an inner diameter of 8-10-13 mm.



Description	Part no.
2-piece	61704L
180 mm	61704L-1
260 mm	61704L-2

## Hose clamp pliers set



e.g. for brake, petrol, coolant pipes etc., resistant to oil and acids, with catch closure

- 150 mm for diameters up to 15 mm
- 180 mm for diameters up to 30 mm
- 250 mm for diameters up to 60 mm



Description	Part no.
3-piece	61705L

## Hose clamp set



with swivelling metal hoop, for petrol hoses and plastic lines.

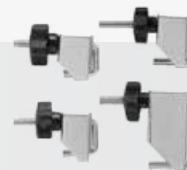

Description	Part no.
4-piece	61720L
up to 10 mm diameter	61709L
up to 15 mm diameter	61710L
up to 25 mm diameter	61711L
up to 45 mm diameter	61712L

## Refilling pump



and emergency pump for various liquids, resistant to petrol and oil, hose length ca. 2 m



Part no.	24005L
----------	--------

## Refilling pump



Metal version, including 2 hoses for intake and outlet, 500 cm<sup>3</sup>. The ball valve clearly separates the suction and pressure stroke. Can be used for

- petrol, diesel, heating oil
- coolant, white spirit
- brake fluid and oils



Part no.	24025L
----------	--------

## Hose pump

Shaking pumps for the transfer-filling of water, fuel, etc.

- No manual suction necessary, thus the inadvertent swallowing of malodorous, foul tasting and toxic liquids is avoided.
- inner diameter 13 mm
- outer diameter 17 mm



Length

1800 mm

Part no.

24003L

## Multi-purpose pump

for replenishing fluids e.g. brake fluid, oil, fuel and cleaning agent.

With 500 mm hose and filling hook for places that are difficult to access.

① 1 liter



Part no.

24002L

## Vacuum pump

for universal use, for building up pressure and vacuum. Complete with hose and various couplings in a case. Ideal for brake and clutch bleeder and to bleed the fuel system e.g. on (ISA) V6 TDI engines as well as for testing of:

- vacuum cells e.g. on air-conditioning systems
- turbochargers etc.
- vacuum - 0,8 bar
- pressure - 4 bar



Description

25-piece

Part no.

01424L

## Bleeder pump

Bleeder pump for passenger cars and motorbikes

- for the fast bleeding of brake systems on passenger cars and motorbikes without pneumatic insert
- can also be used for bleeding fuel filters on diesel and petrol engines

Scope of delivery:

- manometer
- hand pump
- rubber sleeves
- adapter for all brake nipples
- two short hoses
- tank with cover

① Vacuum up to - 0,8 bar



Description

13-piece

Part no.

01425L



## Injection nozzle extractor



for easy and professional dismantling of the nozzles on MAN and Mercedes-Benz trucks

MAN LKW  
Mercedes-Benz LKW

- Carbon steel extractor with 4-tooth foot and 27 mm hex to apply counterpressure
- M14 extracting spindle
- Extracting spindle with 6 mm internal hex to dismantle the nozzle on spindles



Length  
105 mm

Part no.  
26014L

## Filter removal key for diesel filters



for easy and damage free removal and re-fitting of tight fuel filter housings that are not easy to access. Especially designed for Ford Transit with 2.2 TDCi engines.

Ford

- material: Chrome-Molybdenum
- surface: phosphated
- 10 mm (3/8") drive



Suitable for:

- Ford Transit Custom from 04/2012
- Ford Tourneo Custom from 04/2012
- Ford Transit from 08/2013

Part no.  
26204L

## Diesel fuel filter socket



Special socket required for the removal of Diesel fuel filter fitted to 2.0 HDi und 2.2 HDi engines.

Volvo  
Ford  
Fiat  
Citroën  
Peugeot

For Citroën, Fiat, Ford, Lancia, Land Rover, Mitsubishi, Peugeot und Volvo:

- Citroën C4, C5, C8, Picasso, Jumpy
- Fiat Scudo, Ulysse Mk II JTD
- Ford Focus, Focus C-Max, Galaxy, Kuga, S-Max TDCi
- Peugeot 307, 308, 407, 607, 807, Expert
- Volvo C30, C70, S40 Mk II, V50 (136 HP)



Part no.  
26002L

## Mounting lever for diesel fuel fitter



In VAG vehicles, e.g. For Audi, Seat, Škoda and VW with 2.0L TDI engines.

VW  
Škoda  
Seat  
Audi

For disassembling and assembling the fuel filter cover, to avoid distortion of the fuel filter and leakage.



Description  
6 adjustment levels

Part no.  
61703L

## Diesel fuel filters removal set



Lancia  
Fiat  
Opel



For the damage-free opening of the housing cover when changing the fuel filter element.

Contains:

- plastic clamping fixture for the filter housing in the vice
- special wrench with 12.5 mm (1/2") drive for removing the housing cover

Suitable for:

- Opel with engine code DA13, Z13DT, Z13DTH, Z13DTJ, Z19DT, Z19DTL, Z19DTH (not for Corsa-D and Meriva from '07)
- Fiat / Lancia with engine code (1.3l 16V) MJTD, JDT / (1.9l 8V) JTD / (2.0l 8V) JDT / (2.2l 16V) JTD / (2.3l 16V) JDT / (2.8l) JTD / (3.0l 16V) JDT

Can be used equivalent to:

- Diesel fuel filter tool Opel OE EN-46784

Is composed of:

- Special wrench Opel OE EN-46784-10
- Clamping device Opel OE EN-46784-10

⚠ Heed tightening torque of 30 Nm!



Description

Part no.

2-piece

26006L

## Universal tank sensor key



for the damage-free loosening and tightening of the tank sensor union nut on the fuel tank.

- with 3 arms
- 16 mm hexagon drive
- adjustable diameter 89–170 mm
- knurled locking mechanism allows for more precise adjustment of arm position
- for universal use



Part no.

26203L

## Special spanner

for injection lines 12.5 mm (1/2") drive



BMW



Description

S 1

Part no.

BMW

14 mm

26121L

for BMW, Opel, Mercedes-Benz

17 mm

26122L

for Mercedes-Benz

19 mm

26123L

## Brake line spanner set, Hexagonal

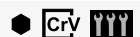

Chrome-vanadium, with flexible joints, in plastic folding box, also ideal for screw attachment jobs on air-conditioning systems, hydraulic and brake lines, power steering etc.

Size:

- 9 x 11 mm, 10 x 12 mm, 13 x 14 mm, 15 x 17 mm, 16 x 18 mm, 19 x 21 mm



Description

Part no.

6-piece

01488L



## Brake line spanner, Hexagonal



Chrome-vanadium, with flexible joints, also ideal for screw attachment jobs on air-conditioning systems, hydraulic and brake lines, power steering etc.



Description
10 x 11 mm
12 x 13 mm

Part no.
01488L-2
01488L-3

## Brake line spanner set, Hexagonal



Brake pipe metric spanner set, hex. Open ring key set, also ideal for brake lines.

- 8 x 10 mm
- 9 x 11 mm
- 12 x 13 mm
- 14 x 15 mm
- 16 x 18 mm
- 17 x 19 mm



Description
6-piece

Part no.
01415L

## Brake line spanner, Hexagonal



open-ended ring spanner, also ideal for brake lines



Description
8 x 10 mm
9 x 11 mm
12 x 13 mm
14 x 15 mm
16 x 18 mm
17 x 19 mm

Part no.
01415L-1
01415L-2
01415L-3
01415L-4
01415L-5
01415L-6

## Open ring spanners



on clamping rail, ideal for injection lines, air-conditioning systems, brake lines, compressed air and hydraulic lines, power steering 10 mm (3/8") drive.



Description
10-piece, 10-11-12-13-14-15-16-17-18-19 mm

Part no.
01480L



## Open-ended ring spanner

ideal for injection lines, air conditioning systems, brake lines, compressed air and hydraulic lines and the power steering 10 mm (3/8") drive.



Size	Part no.
10 mm	01480L-10
11 mm	01480L-11
12 mm	01480L-12
13 mm	01480L-13
14 mm	01480L-14
15 mm	01480L-15
16 mm	01480L-16
17 mm	01480L-17
18 mm	01480L-18
19 mm	01480L-19

## Open ring spanners

on clamping rail, ideal for injection lines, air-conditioning systems, brake lines, compressed air and hydraulic lines, oil pressure switches, 12,5 mm (1/2") drive

- 20, 21, 22, 23, 24, 25, 26, 27, 28, 30, 32 mm
- extension 125 mm
- breaker bar 385 mm



MAN LKW  
Mercedes-Benz LKW

Description	Part no.
13-piece	01490L
Empty box	01490L-KOFFER

## Open ring spanner

ideal for injection lines, air-conditioning systems, brake lines, compressed air and hydraulic lines, oil pressure switches, 12,5 mm (1/2") drive

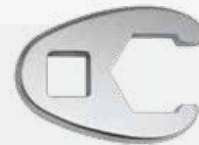

Size	Part no.
20 mm	01490L-20
21 mm	01490L-21
22 mm	01490L-22
23 mm	01490L-23
24 mm	01490L-24
25 mm	01490L-25
26 mm	01490L-26
27 mm	01490L-27
28 mm	01490L-28
30 mm	01490L-30
32 mm	01490L-32

## Special bits

Chrome-vanadium, hardened, matt chrome-plated

- slotted bits in 10, 11, 12, 14, 17 and 19 mm
- for fitting temperature sensors, thermal switches and other components with cables at the top and at the side
- also suitable for screw connections for angled pipes
- the slot width is: 7.4 mm - 8.5 mm - 9.1 mm - 10.5 mm - 13 mm and 14.4 mm
- incl. metal rail



Description	Part no.
6-piece	01482L

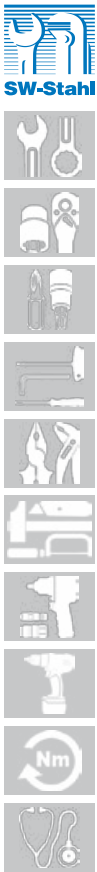

## Special spanner sockets

Special assortment of open and closed spanner sockets for lambda probes in all installation positions, chrome-vanadium, burnished.

- 12.5 mm (1/2") drive:
  - 30 mm double hexagon, 80 mm long (Bosch, GM, DB)
  - 27 mm hexagon, 80 mm long (universal)
  - 28 mm double hexagon, 80 mm long (Alfa Romeo, Chrysler, Rover, MAN 2,5 TD, Volvo, Scania, HGV)
  - 21 mm double hexagon, 85 mm long (Ford, VAG)
  - 27 mm double hexagon, 85 mm long (Diesel injectors BMW M21, M41, M51-Motoren, Fiat, Ford, Peugeot, VW and Mercedes-Benz)
  - 22 mm double hexagon, 80 mm long (universal)
  - 27 mm double hexagon, 110 mm long (Citroën, Peugeot)
  - 22 mm double hexagon, 110 mm long (Audi, BMW, Mercedes-Benz, VW, Volvo)
  - 22 mm double hexagon, 150 mm long (BMW)
  - 20 mm hexagon, 80 mm long, slotted (universal)
  - 19 mm double hexagon, 80 mm long (VW, Audi, Seat)
  - 17 mm double hexagon, 80 mm long (BMW, Mercedes-Benz, Renault)
  - 22 mm double hexagon, 50 mm long, offset (universal)
- 10 mm (3/8") drive:
  - 22 mm hexagon, 30 mm long, offset (universal)

① universal - lambda probes / thermal switches / injection nozzles



- 10 3/8
- MAN  
Rover  
Chrysler  
BMW  
Alfa Romeo  
Volvo  
Scania LKW  
Renault  
Peugeot  
General Motors  
Citroën  
Audi  
Fiat  
Ford  
Mercedes-Benz  
Opel  
Seat  
Škoda  
VW

Description	Part no.
14-piece	26042L

## Special sets of deep spanner sockets

A special range of open and closed deep spanner sockets for use with Lambda probes in all installation positions, thermal switches for the Opel cooler unit fan as well as for Diesel injection nozzles without damaging the fuel return line. Can be used on nearly all vehicles.

Includes the following sizes:

- Hexagon wrench size 29 x 90 mm, 12,5 mm (1/2") drive, with slot
- Hexagon wrench size 22 x 90 mm, 10 mm (3/8") drive, with slot
- Bihexagon wrench size 27 x 83 mm, 12,5 mm (1/2") drive, with opening
- Hexagon wrench size 27 x 74 mm, 10 mm (3/8") drive
- Hexagon wrench size 22 x 80 mm, 10 mm (3/8") drive, with slot
- Hexagon wrench size 22, 10 mm (3/8") drive, angled, slotted
- Hexagon wrench size 22, 12,5 mm (1/2"), angled, slotted

① Universal - lambda probes / thermal switches / injection nozzles



- 10 3/8 12.5 1/2
- Opel  
Chrysler  
Fiat  
Ford  
Mercedes-Benz  
Seat  
Škoda  
VW

Description	Part no.
7-piece	26045L

## Lambda sensor release tool

12.5 mm (1/2") drive

L-form with lateral offset drive



- 12.5 1/2
- VW  
Škoda  
Seat  
Opel  
Mercedes-Benz  
Ford  
Fiat  
Chrysler

Size	Part no.
22 mm	26045L-1
22 mm	26045L-2

## Lambda sensor release tool

10 mm (3/8") drive

L-form with lateral offset drive



Seat  
Škoda  
VW  
Opel  
Mercedes-Benz  
Ford  
Fiat  
Chrysler



Size	Part no.
22 mm	26045L-2

## Socket spanner bit, Hexagonal

7 mm (1/2"), slot width for 12.5 mm (1/2") drive



Size	Length	Part no.
29 mm	90 mm	26045L-3

## Socket spanner bit, Hexagonal

with 18 mm (3/8"), slot width for 10 mm (3/8") drive



Size	Length	Part no.
22 mm	90 mm	26045L-4

## Socket spanner bit, Double hexagon

closed-ended, with lateral opening for 12.5 mm (1/2") drive



Size	Length	Part no.
27 mm	83 mm	26045L-5

## Socket spanner bit, hexagonal

with 8 mm (3/8"), slot width for 10 mm (3/8") drive



Size	Length	Part no.
22 mm	80 mm	26045L-6

## Socket spanner bit, Hexagonal

closed-ended, for 10 mm (3/8") drive



Size	Length	Part no.
27 mm	74 mm	26045L-7





## Pin and groove nut set



for the pressure screws on the nozzle holder

Mercedes-Benz LKW  
MAN LKW

- 1 socket 12.5 mm (1/2") drive, 4-tooth, 72 mm long (for Mercedes-Benz series OM 401/421, 403/423, LA, A, 470)
- 1 socket with 32 mm outer hexagon drive, 4-tooth with inner thread M14x 1.5 mm, 70 mm long (for Mercedes, Neoplan, Setra)
- 1 socket 12.5 mm (1/2") drive, 3-tooth, 120 mm long (for Mercedes, MAN)
- 1 socket with 32 mm outer hexagon drive, 4-tooth, 120 mm long (for Mercedes-Benz, MAN)



ⓘ OM401, OM402, OM403, OM404, OM407, OM409, OM421, OM422, OM423, OM424, OM441, OM442, OM443, OM444, OM427, OM429, OM447

Description	Part no.
4-piece	10325L

## Special spanner socket



for mounting the pressure valve on diesel injection pumps on MAN TGA vehicles



Description	Length	Part no.
34 teeth	40 mm	26032L

## Thread cutting tool set



9 part set in a plastic case, for the servicing and repairing the thread on/in the connecting piece for the gas/fluid lines of refrigeration, gas and hydraulic equipment.

The thread size of the individually contained chaser is marked separately. Through this it can be used for measuring and determining thread sizes.

- for trimming and cleaning outer and inner threads
- the drive takes place via a jointly supplied axle or socket wrench insert
- sizes that are contained: M14x1.5 - M16x1.5 - M18x1.5 - M20x1.5 - M22x1.5 - M24x1.5 - M27x2.0 - M28x1.5



Description	Part no.
M14 - M28 - 9-piece	82240L

## SW-Stahl Multi-Tape



For fast emergency repairs on vehicles, machinery and boats. Can be used both for sealing hoses, tubes or lines as well as for insulating cables and plug connectors. The silicone tape adheres only to itself so it is not dependent on the condition of the substrate, which can be a problem with conventional tapes. The upshot is it can also be processed on oily, wet and dirty substrates. Ideal for instance for damage caused by martens on the radiator hose and repairs when the spare part is not in stock or the time schedule is full. That way, the customer can still use the vehicle until the next appointment.

- Resistant to fuel, oils, acids, solvents and salt
- Waterproof and airtight in seconds
- Immediately self-sealing
- Durably resilient
- UV resistant
- Flexible up to 400%
- Long-term seal
- Even works under water
- Insulates up to 12,000 volts (per layer)
- Temperature-resistant from -65°C to 260°C
- Can be removed residue-free
- Compression-proof up to 12 bar (on a hose diameter of 25 mm)
- Comes in a practical, reclosable plastic box

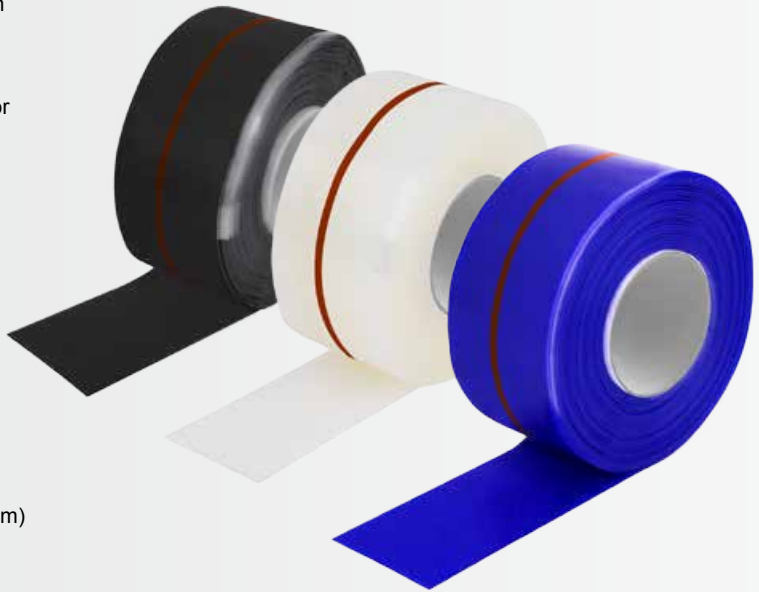

Description	Length	Width	Part no.
SW-Stahl Multi-Tape, black	3,60 m	25,40 mm	62016L
SW-Stahl Multi-Tape, blue	3,60 m	25,40 mm	62017L
SW-Stahl Multi-Tape, transparent	3,60 m	25,40 mm	62018L

## Multi-Tape counter display

Products:

- Counter display with 9 hooks
- 18x Multi-Tape 62016L black
- 6x Multi-Tape 62017L blue
- 3x Multi-Tape 62018L transparent



Description	Part no.
37-piece	62019L

## Fan hub spanner set

particularly thin and slightly offset spanner for holding the visco clutch drive shaft in place on Audi, BMW, Ford, Opel, GM etc.

Also suitable for loosening or tightening the visco fan on VW Passat

32 mm + 36 mm



**BMW**  
**Ford**  
**Opel**  
**General Motors**  
**VW**  
**Audi**

Description	Length	Part no.
2-piece	270 mm	00120SB





## Fan hub spanner set

particularly thin and slightly offset spanner

- 32 mm x 270 mm
- for holding the visco clutch driving shaft in place
- on BMW and Ford
- 36 mm x 270 mm
- for holding the visco clutch driving shaft in place
- on Ford, Opel and GM
- 41 mm x 270 mm
- for turning the water pump on Opel and GM
- in order to tension the drive belt on TDC engines with 1.2 l + 1.6 l capacity
- 46 mm x 270 mm
- for turning the water pump on Opel and GM
- in order to tension the drive belt on TDC engines with 1.6 l + 1.8 l + 2.0 l capacity



**Ford**  
**BMW**  
**Opel**  
**General Motors**  
**Daewoo**

Description	Length	Part no.
4-piece	270	00126L

## Fan hub spanner

particularly thin and slightly offset spanner

- 41 mm x 270 mm

for turning the water pump on Opel and GM  
in order to tension the drive belt on TDC engines



**Opel**  
**General Motors**

Size	Length	Part no.
41 mm	270	00123L
46 mm	270	00124L

## Fan hub spanner set

for holding the visco clutch drive shaft on BMW, Mercedes and Ford,

Makes it possible for the mechanic to hold the belt pulley of the water pump in place while the heater fan is loosened at the same time. Also includes the interior hexagon key for loosening the fan disc as well as mounting the fan clutch and the belt pulley on the water pump.

Also for removing the viscous connector on the radiator fan



**BMW**  
**Ford**  
**Mercedes-Benz**

Description	Part no.
11-piece	00125L

### Digital infrared thermometer



With laser pointer, automatic shutdown, illuminated digital display, ideal for measurements on hot or rotating parts, liquids or spots that are difficult to reach.

- measuring range -50 to + 550°C
- measuring accuracy
- operating temperature: 0° - 50°C
- distance factor 12 : 1
- switchable °F / °C
- incl. 2x AAA battery



Part no.  
**72360L**

### Water pump tool set



for removing the water pump in 2.5l 5-cylinder TDI engines  
VW T5, Touareg

VW

- 1 toothed wheel pull-off tool for removing the water pump toothed wheel
- 1 water pump pull-off tool for removing the water pump
- Key for crankshaft T5 for holding or turning the crankshaft while loosening the gear wheel attachment screw on the water pump. Also required for the TDC adjustment of the engine shafts
- includes equivalent tools to T10221 and T10222



Description  
5-piece

Part no.  
**26028L**



## Radiator removal tool case

Complete with a pump, thermometer and radiator adapters for almost all passenger cars and light trucks, packed in a plastic case.

- measuring range 0 - 2.5 bar
- check on pressure loss through the manometer
- test possibility in relation to locking caps
- pressure testing of the refrigerator system
- inc. vacuum servicing set for cleaning the radiator and topping up the coolant

### Contains:

- Replacement pump with hose 0 - 2,5 bar
- Adapter No. 3 - Mercedes-Benz (W123, 126, 124, 201) GM (Buick) Jeep
- Adapter No. 4 - Peugeot, Subaru, Chrysler, Acura, GM (Nova, Spectrum, Sprint), Mitsubishi, Nissan, Mazda, Toyota, Infinity, Ford
- Adapter No. 5 - Honda, Toyota, Suzuki, Mitsubishi, Chrysler, Acura, Lexus
- Adapter No. 6 - Mercedes-Benz (ML-Class, W163, 164) GM (Achiva, Skylark Grand Am 1992-2002), VW T5
- Adapter No. 7 - Volvo, Saab, Sterling, Citroën, Renault Scénic 130 Dci, Fiat, Alfa, Jeep, Mini
- Adapter No. 8 - VW (Vento, T4, Passat 1996, Golf, Beetle, Sharan)
- Adapter No. 9 - Audi (A4, A5, A6), BMW, VW (Passat 1,9L TDI, Golf 1.4i FSI, Touran TSI 1,4L), Škoda (Fabia 1,4L), Porsche (Cayenne)
- Adapter No. 10 - BMW (E32, E34, E36, E38, E39, E46, E90)
- Adapter No. 11 - Audi, VW
- Adapter No. 12 - Ford International, Land Rover, Opel, Jaguar, Ssangyong-Motor
- Adapter No. 13 - Mercedes-Benz (C-Class, E-Class, S-Class, W140, W220, W124, W210; W215, W216, W221, R230)
- Adapter No. 14 - Ford Mondeo, Focus, C-Max -ab 03
- Adapter No. 15 - Mazda (M3)
- Adapter No. 16 - Mercedes-Benz A-Class 1.5L
- Adapter No. 17 - BMW E60, E63, E64, E65
- Adapter No. 18 - VW Sharan 1.8T, 2.8L, Seat Alhambra
- Adapter No. 19 - Toyota RAV4, Previa
- Plastic key
- Thermometer
- Connecting piece R123/124 (blue) and R123/125 (black)
- Cooling system refill valve



**Description**  
25-piece

**Part no.**  
21030L



## Radiator removal tool case

YYY

Complete with a pump, thermometer and radiator adapters for almost all passenger cars and light trucks, packed in a plastic case.

- measuring range 0 - 2.5 bar
- control of pressure loss through manometer
- testing possibility for locking caps
- cooling system pressure test

Contains:

- Replacement pump with hose 0 - 2,5 bar
- Adapter no. 3 - Mercedes-Benz (W123, 126, 124, 201) GM (Buick) Jeep
- Adapter no. 4 - Peugeot, Subaru, Chrysler, Acura, GM (Nova, Spectrum, Sprint), Mitsubishi, Nissan, Mazda, Toyota, Infinity, Ford
- Adapter no. 5 - Honda, Toyota, Suzuki, Mitsubishi, Chrysler, Acura, Lexus
- Adapter no. 6 - Mercedes-Benz (ML-Class, W163, 164) GM (Achiva, Skylark Grand Am 1992-2002), VW T5
- Adapter no. 7 - Volvo, Saab, Sterling, Citroën, Renault Scénic 130 Dci, Fiat, Alfa, Jeep, Mini
- Adapter no. 8 - VW (Vento, T4, Passat 1996, Golf, Beetle, Sharan)
- Adapter no. 9 - Audi (A4, A5, A6), BMW, VW (Passat 1,9L TDI, Golf 1.4i FSI, Touran TSI 1,4L), Škoda (Fabia 1,4L), Porsche (Cayenne)
- Adapter no. 10 - BMW (E32, E34, E36, E38, E39, E46, E90)
- Adapter no. 11 - Audi, VW
- Adapter no. 12 - Ford International, Land Rover, Opel, Jaguar, Ssangyong-Motor
- Adapter Nr. 13 - Mercedes-Benz (C-Class, E-Class, S-Class, W140, W220, W124, W210; W215, W216, W221, R230)
- Adapter no. 14 - Ford Mondeo, Focus, C-Max - from 03
- Adapter no. 15 - Mazda (M3)
- Plastic key
- Thermometer
- Connecting piece R123/124 (blue) and R123/125 (black)



Description

18-piece

Part no.

21000L

## Cooler squeeze off adapter

YYY

universal, to squeeze off the cooling system and quickly localise leaks in the cooling circuit.

- Flexible rubber adapter for interior diameters 30 - 50 mm
- Anodised aluminium



① Suitable for 21001L, 21000L, 21030L and 21040L

Inner diameter

30 - 35 mm

35 - 40 mm

40 - 45 mm

45 - 50 mm

Part no.

21049L

21049L-1

21049L-2

21049L-3

## Replacement pump

YYY

0 - 2.5 bar  
for radiator removal tool case 21000L, 21030L, 21040L



① Also suitable as addition to 21000L

Description

Replacement pump

Cooling system refill mounting

Thermometer

Part no.

21001L

21026L

21023L



## Cooler adapter



for cooler adapter squeeze off tool kit 21000L and 21030L.

Jeep  
General Motors  
Buick  
Mercedes-Benz

- valve diameter: 38 mm
- valve height: 25 mm
- cap diameter: 58 mm



Description	Part no.
Adapter Nr. 3 - Mercedes-Benz (W123, 126, 124, 201, Unimog) GM (Buick) Jeep	<b>21004L</b>
Adapter Nr. 4 - Peugeot, Subaru, Chrysler, Acura, GM (Nova, Spectrum, Sprint), Mitsubishi, Nissan, Mazda, Toyota, Infinity, Ford	<b>21005L</b>
Adapter Nr. 5 - Honda, Toyota, Suzuki, Mitsubishi, Chrysler, Acura, Lexus	<b>21006L</b>

## Cooler adapter



for cooler adapter squeeze off tool kit 21000L and 21030L.

Buick  
General Motors  
Mercedes-Benz  
Ford  
Daewoo  
Land Rover  
Porsche  
Saab  
Opel



Description	Part no.
Adapter no. 6 - Mercedes-Benz (ML-Class, W163, 164) GM (Achiva, Skylark Grand Am '92-'02), Daewoo ('99-'01), Ford (Fiesta from '95, Focus from '98, Fusion from '06), Opel (Astra F and G, Corsa B, Tigra, Vectra, Zafira Motorcode Z20LET), Porsche (911 from '99, Boxter from '97), Saab (900 '94-'98), Land Rover (Discovery '89-'04), Range Rover ('88-'94)	<b>21007L</b>
Adapter no. 7 - Volvo, Saab, Sterling, Citroën, Renault Scénic 130 Dci, Fiat, Alfa, Jeep, Mini	<b>21008L</b>
Adapter no. 8 - VW (Vento, T4, T5, Passat 1996, Golf, Beetle, Sharan)	<b>21009L</b>
Adapter no. 9 - Audi (A4, A5, A6), BMW, VW (Passat 1.9L TDI, Golf 1.4l FSI, Touran TSI 1.4L), Škoda (Fabia 1.4L), Porsche (Cayenne)	<b>21011L</b>
Adapter no. 10 - BMW (E32, E34, E36, E38, E39, E46, E90)	<b>21012L</b>
Adapter no. 11 - Audi, VW, VW T3	<b>21013L</b>
Adapter no. 12 - Ford International, Land Rover, Opel z.B. Insignia or Corsa D, Jaguar, Ssangyong-Motor	<b>21014L</b>
Adapter no. 13 - Mercedes-Benz (C-Class, E-Class, S-Class, W140, W220, W124, W210; W215, W216, W221, R230)	<b>21015L</b>
Adapter no. 14 - Ford Mondeo, C-Max - from 03	<b>21016L</b>
Adapter no. 15 - Mazda (M3), Ford from '11	<b>21017L</b>
Adapter no. 16 - Mercedes-Benz A-Class 1.5 l / Sprinter 319 CDI from Bj. '09, Model 906	<b>21018L</b>
Adapter no. 17 - BMW E60, E63, E64, E65, F11	<b>21019L</b>
Adapter no. 18 - VW Sharan 1.8T, 2.8L, Seat Alhambra	<b>21020L</b>
Adapter no. 19 - Toyota RAV4, Previa	<b>21021L</b>
Adapter no. 21 - Opel Astra J, Zafira C	<b>21027L</b>

## Test nozzle



for cooler adapter squeeze off tool kit 21000L and 21030L.



Description	Part no.
Connecting piece R123/125 (blue)	<b>21024L</b>
Connecting piece R123/124 (black)	<b>21025L</b>

## Radiator removal tool case

Complete with pump and seven radiator adapters for common trucks from DAF, IVECO, Mercedes-Benz, MAN, Scania, Renault and Volvo.

- measuring range 0 - 2.5 bar
- check on pressure loss through manometer
- possibility of testing locking caps
- pressure test on the cooling system



MAN LKW  
Iveco LKW  
DAF  
Mercedes-Benz LKW  
Renault LKW  
Scania LKW  
Volvo LKW



① Only compatible with 21002L

Description	Part no.
8-piece	21040L
Pump without tube	21002L
Tube	21003L
Adapter SCANIA-113, -114, -124 und -125	21042L
Adapter DAF-XF 95, XF 105	21043L
Adapter 40-150, MB-Actros, -Atego, Axor, -ECO 8401, LKW 1728, MAN-F 90, -F 2000, IVECO-EURO-Star, EURO-Tech, Euro-Truck, Strahlis	21044L
Adapter IVECO-Daily 2000 C-Serie, RENAULT-Magnum	21045L
Adapter MAN L2000	21046L
Adapter Volvo FH 12	21047L
Adapter MB Sprinter bis 06, Vito	21048L

## CO<sup>2</sup> leak detector

For all water-cooled combustion engines, to be used in combination with our radiator removal tool 21000L / 21030L. Indicates the occurrence of CO<sup>2</sup> exactly in the cooling system. The CO<sup>2</sup> gases cause the testing fluid to change colour from blue to yellow.

This process can be reversed by adding outer air.



① Suitable for petrol-, diesel-, and gas vehicles

Description	Part no.
5-piece	21050L
Testing fluid 300 ml	21051L
Flushing liquid	21052L

## Coolant system testing and filling device

for the straightforward bubble-free filling of coolant systems, at the same time testing for leaks.

- universal version with quick-action coupling
- including flexible hose for working on connections that are difficult to access
- manometer with rubber protection
- with valve for pressure relief



Description	Part no.
6-piece	21010L



## Funnel set



made of plastic.

- Diameter 50, 75, 100, 125 mm



**Description**  
4-piece

**Part no.**  
07378L

## Metal funnel



with flexible pipe and sieve

- pipe length 300 mm
- funnel diameter 145 mm



**Part no.**  
07379L

## Universal filling funnel

Thanks to the self-locking function the funnel can be fixed nearly to all inlet ports. As soon as the funnel is fixed your hands are free to fill in the fluid. The height of the red fixing ring is adjustable for use with every funnel.

- Funnel diameter: 120 mm



**Part no.**  
07382L

## Filling funnel



suitable for engine and gear oil, coolant fluid, fuel, etc.

- with a removable sieve in order to filter out dirt
- with a twist off top and stopper
- funnel diameter 160 mm
- outer diameter of the hose 14 mm
- transparent hose 400 mm long



**Length**  
400 mm

**Part no.**  
07365L

## Filling can



Two carrying handles and the narrow outflow opening allow precise filling even in hard-to-reach places. Ideal for service or petrol station use.

- outlet opening Inside Ø 10 mm / outside Ø 16 mm
- ideal for oil, fuel and cleaning fluids
- temperature resistant from -40 ° C to 85 ° C
- not calibrated



**Description**  
9 litre

**Product property**  
Non calibrated

**Part no.**  
07381L

## Filling can

for oil and battery fluid

- resistant to acids, oils and alkalis
- with threaded spout for filler neck



Description	Product property	Part no.
2 liter	Non calibrated	07371L
4 liter	Non calibrated	07372L

## Pouring nozzle

for filling cans 07371L and 07372L



Part no.  
07368L

## Drip pan

high quality and sturdy design, for collecting oils, fuels, coolants and windscreen wiper fluid



① Fits between the front wheels on passenger cars, with 16 liter capacity

Length	Width	Height	Part no.
560 mm	430 mm	85 mm	07376L
880 mm	600 mm	100 mm	07377L

## Antifreeze tester

with float.



Part no.  
21500L

## Antifreeze and coolant tester

suitable for all ethylene and glycol solutions, also allows optical checks for rust and other impurities

- for ethylene
- for glycol
- for hot and cold liquid



Part no.  
21505L



## Refractometer



for testing battery acid density from 1.1 - 1.4 kg/l and antifreeze coolant from 0° / -50 °C as well as windscreen washing fluid from 0° / -40 °C

- adjustable ocular
- settable calibration fixture
- measuring accuracy +/- 5%

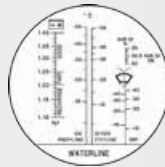

Used equivalent to VAG OEM T10007 A  
Complete in case

① Also suitable for checking the correct mixing ratios for AdBlue® (AUS 32) additives and windshield cleaner based on alcohol (SRF1) and ethanol.

Description	Part no.
Complete in case	21550L
Replacement glass	21550L-1
Pipette	21550L-2

## Pinch off pliers



e.g. for brake, petrol, coolant pipes etc..  
With easy one-hand catch closure.

- 180 mm for diameters up to 19 mm
- 260 mm for diameters up to 57 mm



Description	Part no.
2-piece	61704L
Pinch off pliers 180 mm	61704L-1
Pinch off pliers 260 mm	61704L-2

## Hose clamp pliers set



e.g. for brake, petrol, coolant pipes etc.,  
resistant to oil and acids, with catch closure

- 150 mm for diameters up to 15 mm
- 180 mm for diameters up to 30 mm
- 250 mm for diameters up to 60 mm



Description	Part no.
3-piece	61705L

## Hose clamp set



with swivelling metal hoop, for  
petrol hoses and plastic lines.

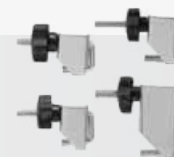

Description	Part no.
4-teilig	61720L
up to 10 mm diameter	61709L
up to 15 mm diameter	61710L
up to 25 mm diameter	61711L
up to 45 mm diameter	61712L

## Band-type clamp pliers



for spring-loaded band-type clamps,  
clamp seat can be turned



Description	Length	Part no.
straight model	200 mm	61760L

## Band-type clamp pliers

for spring-loaded band-type clamps, clamp seat can be turned



Description	Length	Part no.
angled Modell	240 mm	61765L

## Spring clip pliers

mit gehärteten Backen.  
with hardened jaws  
For fitting and removing small spring clips with three ends e.g. on fuel and tank bleeding pipes on Audi, VW, Seat, Škoda vehicles etc.



Audi  
Seat  
Škoda  
VW

Description	Length	Part no.
Clamping range up to 28 mm	192 mm	45001L

## Band-type clamp pliers

for self-clamping spring clamps from 18 – 54 mm on fuel and coolant hoses.

- with bowden cable, suitable for all installation spots which are difficult to access
- safe hold thanks to lever locking

e.g. for:

- Alfa, Audi, Citroën, Fiat, Ford, Hyundai, Lancia, MAN, Mercedes-Benz, Mini (BMW), Opel, Peugeot, Porsche, Renault, Seat, Toyota, VW, Volvo, etc.



Alfa Romeo  
Audi  
Citroën  
Fiat  
Ford  
Hyundai  
Lancia  
MAN  
Mercedes-Benz  
Mini  
Opel  
Peugeot  
Porsche  
Renault  
Seat  
Toyota  
Volvo  
VW

Description	Length	Part no.
Band-type clamp pliers with bowden cable	630 mm	61777L
Replacement bowden cable	630 mm	61777L-1

## Hose clamp tool, Hexagonal

Flexible, with encapsulated shaft for protection from humidity, dirt and rust.



Profile	D	Length	Part no.
●	6 mm	260 mm	02076L
●	7 mm	260 mm	02077L
●	8 mm	260 mm	02078L

## Hose clamp set

3 m endless strap (8 mm wide), can be worked into clamps of any length, with 8 clamping closures

- Stainless



Part no.  
61742L



## Special sets of deep spanner sockets



Special sets of deep spanner sockets.  
A special range of open and closed deep spanner sockets for use with Lambda probes in all installation positions, thermal switches for the Opel cooler unit fan as well as for Diesel injection nozzles without damaging the fuel return line.

Can be used on nearly all vehicles.

Includes the following sizes:

- Hexagon size 29 x 90 mm, 12,5 mm (1/2") drive, with slot
- Hexagon size 22 x 90 mm, 10 mm (3/8") drive, with slot
- Bihexagon size 27 x 83 mm, 12,5 mm (1/2") drive, with opening
- Hexagon size 27 x 74 mm, 10 mm (3/8") drive
- Hexagon size 22 x 80 mm, 10 mm (3/8") drive, with slot
- Hexagon size 22, 10 mm (3/8") drive, angled, slotted
- Hexagon size 22, 12,5 mm (1/2"), angled, slotted



Opel  
Chrysler  
Fiat  
Ford  
Mercedes-Benz  
Seat  
Škoda  
VW

① Universal - lambda probes / thermal switches / injection nozzles

Description	Part no.
7-piece	26045L

## Special spanner sockets



Special assortment of open and closed spanner sockets for lambda probes in all installation positions, chrome-vanadium, burnished.

- 12.5 mm (1/2") drive:
  - 30 mm double hexagon, 80 mm long (Bosch, GM, DB)
  - 27 mm hexagon, 80 mm long (universal)
  - 28 mm double hexagon, 80 mm long (Alfa Romeo, Chrysler, Rover, MAN 2.5 TD, Volvo, Scania, HGV)
  - 21 mm double hexagon, 85 mm long (Ford, VAG)
  - 27 mm double hexagon, 85 mm long (Diesel injectors BMW M21, M41, M51-Motoren, Fiat, Ford, Peugeot, VW and Mercedes-Benz)
  - 22 mm double hexagon, 80 mm long (universal)
  - 27 mm double hexagon, 110 mm long (Citroën, Peugeot)
  - 22 mm double hexagon, 110 mm long (Audi, BMW, Mercedes-Benz, VW, Volvo)
  - 22 mm double hexagon, 150 mm long (BMW)
  - 20 mm hexagon, 80 mm long, slotted (universal)
  - 19 mm double hexagon, 80 mm long (VW, Audi, Seat)
  - 17 mm double hexagon, 80 mm long (BMW, Mercedes-Benz, Renault)
  - 22 mm double hexagon, 50 mm long, offset (universal)
- 10 mm (3/8") drive:
  - 22 mm hexagon, 30 mm long, offset (universal)



MAN  
Rover  
Chrysler  
BMW  
Alfa Romeo  
Volvo  
Scania LKW  
Renault  
Peugeot  
General Motors  
Citroën  
Audi  
Fiat  
Ford  
Mercedes-Benz  
Opel  
Seat  
Škoda  
VW

① Universal - lambda probes / thermal switches / injection nozzles

Description	Part no.
14-piece	26042L

## Special bits



Chrome-vanadium, hardened, matt chrome-plated

- slotted bits in 10, 11, 12, 14, 17 and 19 mm
- for fitting temperature sensors, thermal switches and other components with cables at the top and at the side
- also suitable for screw connections for angled pipes
- the slot width is: 7.4 mm - 8.5 mm - 9.1 mm - 10.5 mm - 13 mm and 14.4 mm
- incl. metal rail



Description	Part no.
6-piece	01482L



## Oil draining adapter

with hose for VAG 1.8l and 2.0l petrol engines  
(AXW / BGB / BLX / BLR / BLY / BVX / BVY / BVZ / BWE)

- Audi A3 / A4 / A6 / TT
- VW Golf V / Passat / Touran / New Beetle / EOS / Jetta III
- Seat Altea / Leon / Octavia / Toledo

A valve is opened when screwing the adapter into the oil filter housing. Therefore the engine oil can drain in a controlled way through the hose out of the housing. Afterwards the oil filter housing can be easily removed.

- used equivalent to OEM T40057



Part no.  
**08470L**



Seat  
Audi  
VW



## Socket spanner oil drain plug VAG



Socket spanner for professionally loosening and tightening plastic oil drain plugs. Idea for VAG engines with plastic oil sumps which were installed for the first time in 2012.

Suitable for:

- Audi A1, A3, A4, A5, A6, A7, Q3, Q5, Q7, TT, TTS
- Seat Alhambra, Leon, Toledo
- Škoda Octavia, Rapid, Superb, Yeti
- VW Beetle, Caddy, CC, Golf, Jetta, Passat, Polo, Scirocco, Sharan, Tiguan, Touran

Comparable to OE T10549



Part no.  
**03016L**

## Oil service insert-bit socket, Square



e.g. for Ford, Nissan, Mazda, Renault, Peugeot, Volvo etc.



Renault  
Peugeot  
Ford  
Mazda  
Nissan  
Volvo

Description	Profile	Part no.
Size 8 mm / 10 mm interchangeable	□	<b>03000SB</b>

## Special 8-in-1 spanner for oil pans



versatile special spanner for oil draining and filling screws

- Essential for almost all standard applications
- 4 square inserts: 8 - 10 mm and 10 mm (3/8") - 12.5 mm (1/2")
- 4 hexagonal inserts: 8 - 12 - 14 - 17 mm



Part no.  
**03007L**

## Oil servicing key



Multi-purpose bone-type spanner, for fitting and disassembly of the oil drain and filling plugs in oil pan, gearbox and differential with with different square (9.5 - 10.5 - 12 - 12.5 - 13.5 - 14.5 mm) and octagon (13.5 - 17 mm) profiles.



Lenght  
225 mm

Part no.  
**03003L**



## Oil service key set

For universal use on oil pan, gearbox and differential, to be used with spark plug insert or key 21 mm

- hexagon 5/16 x 3/8"
- square 8 x 3/8"
- hexagon 8 x 10 mm
- square 11 mm x hexagon 12 mm
- square 13 mm x hexagon 14 mm
- hexagon 1/2" x 17 mm



**YYY**  
Nissan  
Opel  
Peugeot  
Renault  
Volvo

Part no.  
**03005L**

## Oil service key set

For universal use in the passenger car sector, 10 mm (3/8") drive

- hexagon 8 - 9 - 10 - 12 - 14 - 17 mm + 10 mm (3/8")
- square 8 - 11 - 13 mm + 10 mm (3/8")
- 1 sliding handle



**10 YYY**  
Ford  
Mazda  
Nissan  
Peugeot  
Renault  
Volvo

Description  
12-piece

Part no.  
**03015L**

## Oil drain plug cutter

Cutter set to rework the sealing surface of oil drain plugs fitted to aluminium sumps.

The enclosed guide rod is screwed into the external thread to guarantee ideal centring of the cutting head.



Part no.  
**03040L**

## Oil draining screw repair set

complete with fine-thread tap as well as 5 new oversize oil draining screws and suitable aluminium seals for the given thread size



Description  
33-piece, M15 - M17 - M20

Part no.  
**03020L**

## Oil draining screw repair set

complete with fine-thread tap as well as 5 new oversize oil draining screws and suitable aluminium seals for the given thread size



Description  
11-piece, M13 x 1,5  
11-piece, M15 x 1.5  
11-piece, M20 x 1.5

Part no.  
**03032L**  
**03010L**  
**03028L**

## Screw with aluminium seal

for oil draining screws



Description	Thread	Length	Part no.
Screw M13 x 1,5 with aluminium seal	10 M	25 mm	<b>03029L</b>
Screw M15 x 1.5 with aluminium seal	15 M	25 mm	<b>03011L</b>
Screw M17 x 1,5 with aluminium seal	17 M	25 mm	<b>03033L</b>
Screw M20 x 1.5 with aluminium seal	20 M	19 mm	<b>03025L</b>

## Special drill

for oil draining screws



Description	Thread	Length	Part no.
Special drill M13 x 1,5	13 M	70 mm	<b>03030L</b>
Special drill M15 x 1.5	15 M	70 mm	<b>03012L</b>
Special drill M17 x 1,5	17 M	70 mm	<b>03034L</b>
Special drill M20 x 1.5	20 M	70 mm	<b>03027L</b>

## Aluminium sealing ring

for oil draining screws



Description	Thread	D	Part no.
Aluminium sealing ring M13 x 19 x 1,5	13 M	19 mm	<b>03031L</b>
Aluminium sealing ring M15 x 19 x 1.5	15 M	19 mm	<b>03013L</b>
Aluminium sealing ring M17 x 22 x 1,5	17 M	22 mm	<b>03035L</b>
Aluminium sealing ring M20 x 24 x 1.5	20 M	24 mm	<b>03026L</b>

## Oil tray



- Closed design, especially flat form with 12-cm high edge
- Ideal in narrow spaces in the automotive and motorcycle sectors
- The draining oil is safely collected in the large collection tray
- With 3 carrying handles and 3 openings
- Suitable for oil, petrol, chemicals, antifreeze



Description	Length	Width	Height	Part no.
10 liters, with tray pourer	600 mm	320 mm	115 mm	<b>07373L</b>

## Oil collecting canister



- Ideal for use with passenger cars and motorbikes
- The draining oil is collected safely thanks to the collecting dish
- With 3 carry handles and 2 wheels (dia. 100 mm) for exact positioning
- With 3 sealable openings (draining, pouring and venting opening)
- Suitable for oil, petrol, chemicals, anti-freeze



Description	Length	Width	Height	Part no.
40 liters, with pouring spout, mobile	490 mm	890 mm	190 mm	<b>07363L</b>



## Drip pan

with pourer, made of HDPE: resistant to almost all polar solvents (T < 60°C), acids, alkalies, water, alcohols, oil, petrol.  
Easy to transport thanks to handles.



Description	Width	Height	Part no.
5,5 liters capacity	400 mm	100 mm	07374L
16 liters capacity	440 mm	140 mm	07375L

## Drip pan



high quality and sturdy design, for collecting oils, fuels, coolants and windscreen wiper fluid



① Fits between the front wheels on passenger cars, with 16 liter capacity

Length	Width	Height	Part no.
560 mm	430 mm	85 mm	07376L
880 mm	600 mm	100 mm	07377L

## Filling can



for oil and battery fluid

- resistant to acids, oils and alkalis
- with threaded spout for filler neck



Description	Produkteigenschaft	Part no.
2 liters	Non calibrated	07371L
4 liters	Non calibrated	07372L

## Pouring nozzle



for filling cans 07371L and 07372L



Part no.  
07368L

## Oil filling funnel













for the clean filling of motor oil using suitable adapter fitting and seal. Thanks to the airtight seal with the filling opening, oil can no longer be spilled over the exhaust manifold or engine block. The additional angled extension makes it easier to fill oil in places which are difficult to reach, e.g. on VW Sharan, Ford Galaxy, Seat Alhambra.

- funnel volume 1 liter

with 5 aluminium adapter:

- multipurpose bayonet adapter e.g. for VAG, BMW, Mercedes-Benz (Sprinter), Ford, etc. (suitable for about 75% of all vehicles)
- threaded adapter M32 x 3.5 e.g. for Honda, Nissan
- threaded adapter M35 x 4.0 e.g. for Mazda
- threaded adapter M37 x 3.0 e.g. for Lexus, Toyota
- threaded adapter M42 x 3.5 e.g. for Subaru



-  Audi
-  BMW
-  Ford
-  Honda
-  Lexus
-  Mazda
-  Mercedes-Benz
-  Nissan
-  Seat
-  Subaru
-  Toyota
-  VW
-  Opel

**⚠ Do not use for W12 motors!**









Description	Part no.
7-piece	<b>07362L</b>
Adapter with bajonet closure, e.g. VW Golf VII	<b>07362L-6</b>
Oil filling adapter, with thread	<b>07362L-7</b>
Adapter with bajonet closure, for Toyota	<b>07362L-8</b>

## Oil filling adapter

Universal aluminium adapter with bayonet connector, e.g. for VAG, BMW, Mercedes-Benz Sprinter), Ford, etc.

matches approx. 75% of all vehicles



-  Seat
-  Ford
-  BMW
-  Škoda
-  VW
-  Mercedes-Benz
-  Audi

**⚠ Addition to 07383L!**

Description	Part no.
Universal adapter with bajonet closure	<b>07362L-1</b>
Oil filling adapter with thread M32 x 3.5	<b>07362L-2</b>
Oil filling adapter with thread M35 x 4.0	<b>07362L-3</b>
Oil filling adapter with thread M37 x 3.0	<b>07362L-4</b>
Oil filling adapter with thread M42 x 3.5	<b>07362L-5</b>
Adapter with bajonet closure, e.g. VW Golf VII	<b>07362L-6</b>
Oil filling adapter with thread	<b>07362L-7</b>
Adapter with bajonet closure, for Toyota	<b>07362L-8</b>
Angular extension	<b>07362L-9</b>
Oil filling funnel	<b>07362L-10</b>



## Oil funnel

to fill engine oil without spillage using a matching adapter socket and seal. The tight connection with the filling hole prevents accidental spillage of oil over the exhaust manifold or the engine block.

- Funnel volume 1 litre

With 2 aluminium adapters:

- Universal bayonet adapter, e.g. for VAG, BMW, Mercedes-Benz (Sprinter), Ford, etc. (matches 75% of all vehicles)
- Bayonet adapter for recent VAG models, e.g. Golf VII

ⓘ Addition to 07383L!



Škoda  
Audi  
Seat  
VW

Description	Part no.
3-piece	<b>07383L</b>
Oil filling adapter with thread M32 x 3.5	<b>07362L-2</b>
Oil filling adapter with thread M35 x 4.0	<b>07362L-3</b>
Oil filling adapter with thread M37 x 3.0	<b>07362L-4</b>
Oil filling adapter with thread M42 x 3.5	<b>07362L-5</b>
Oil filling adapter with thread	<b>07362L-7</b>
Adapter with bajonet closure, for Toyota	<b>07362L-8</b>
Angular extension	<b>07362L-9</b>

## Universal filling funnel

Suitable for engine and gear oil, coolant fluid, etc.

Thanks to the self-locking function the funnel can be fixed nearly to all inlet ports. As soon as the funnel is fixed your hands are free to fill in the fluid. The height of the red fixing ring is adjustable for use with every funnel.

- Funnel diameter: 120 mm



Part no.  
**07382L**

## Filling funnel

suitable for engine and gear oil, coolant fluid, fuel, etc.

- with a removable sieve in order to filter out dirt
- with a twist off top and stopper
- funnel diameter 160 mm
- outer diameter of the hose 14 mm
- transparent hose 400 mm long



Part no.  
**07365L**

## Oil filling funnel

- Square shape
- 850 ml capacity



Part no.  
**07369L**

## Paper funnel



for the clean filling of oils and other liquids.

- 100 x 120 mm
- for one-time use



Description	Part no.
250-piece, Paper	07367L

## Oil filter key, Double hexagon



for oil filter changing on the Haldex clutch, suitable for VAG all-wheel drive gearbox on Bora, Golf IV+V, Sharan, Touran as well as TT, A3 and other



Audi  
VW

ⓘ VAG all-wheel drive

Profile	Wrench size	Part no.
	46 mm	410105L

## Oil filter key, Double hexagon



for Ford und PSA cars

Easy and timesaving installation and removal of the specific and difficult reachable oil filter covers.

- Citroën C4 Picasso 2.0 HDi (from '09/10)
- Citroën C5 2.0 16V HDi (from '10)
- Citroën C5 2.2 HDi (from 10/'10)
- Citroën C8 2.0 HDi (from '10)
- Citroën DS4 2.0 HDi (from '11)
- Citroën DS5 2.0 HDi (from '11)
- Ford C-Max 2.0 TDCi (from '10)
- Ford Galaxy 2.0 TDCi (from '10)
- Ford Galaxy 2.2 TDCi (from '10)
- Ford Kuga 2.0 TDCi (from '10)
- Ford Mondeo 2.0 TDCi (from '10)
- Ford Mondeo 2.2 TDCi (from '10)
- Ford S-Max 2.0 TDCi (from '10)
- Ford S-Max 2.2 TDCi (from '10)
- Jaguar XF 2.2D Sportbrake (from '12)
- Peugeot 308 2.0 HDi (from '11)
- Peugeot 407 2.0 HDi ('10-11)
- Peugeot 407 Coupé 2.0 HDi ('09-12)
- Peugeot 508 2.0 HDi (from 10/'10)
- Peugeot 508 2.2 HDi (from 10/'10)
- Peugeot 3008 2.0 16V HDi (from 07/'09)
- Peugeot 5008 2.0 HDi (from 12/'09)
- Peugeot RCZ 2.0 HDi (from 04/'10)



Peugeot  
Jaguar  
Ford  
Citroën

Profile	Wrench size	Part no.
	27 mm	08431L



## Oil filter key, Double hexagon



Especially for Renault EF34 76 mm double-hexagon oil filter.

Renault  
Ford  
Peugeot

- Oil filters that have become stuck can be loosened easily thanks to the long handle

Suitable for the following models:

- Renault R5 Twingo, Rapid with C petrol engine, Clio, Kangoo with petrol engine, R12
- Espace III, Laguna with F petrol engine, Mégane Kangoo with K petrol engines, R21
- Espace I+III with F petrol engines and Traffic with J petrol engines
- Ford 1.8 diesel and Motorcraft – filter EFL344
- Peugeot with Purflux filter



Profile	Wrench size	Part no.
	76 mm	08445L

## Filter loosening key



3-arms, 10 mm (3/8") square drive, with adapter 12,5 mm (1/2") square drive / 21 mm hexagon, for filters with a Ø between 69 - 130 mm.



Description	Part no.
Universal	08410L

## Heavy duty filter loosening key



For air dryer cartridges and oil filters, right and left operation, therefore suitable for loosening and tightening.

- diameter of ca. 104 - 165 mm
- length of gripping arms 60 mm
- 12,5 mm (1/2") drive
- extra heavy version 1366 g

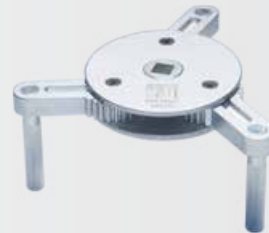

**Right and left operation!**

Part no.  
08405L

## Filter loosening key



suitable for universal use; can be used with socket spanner size 21 as well as with a 12.5 mm (1/2") ratchet.

Optimum hold and interlock is given through stable self-clamping attachment and the toothed cheeks. Clockwise and anti-clockwise operation, thus suitable for loosening and tightening.



**Right and left operation!**

Description	Part no.
Clamping range 60 - 80 mm, size 21	08411L
Clamping range 80 - 110 mm, size 21	08412L
Clamping range 105 - 145 mm, size 24	08413L

## Oil filter key

Universal, self-tensioning, for diameter from 80 – 105 mm



Description	Part no.
Plastic handle	08401SB



## Oil filter chain key



12,5 mm (1/2") drive



### Description

Normal chain for oil filters up to ca. 115 mm diameter  
Professional version for oil filters up to ca. 115 mm diameter

### Part no.

**08300SB**  
**08310L**

## Oil filter chain key with handle



suitable for oil filters with 60 - 105 mm diameter

- extremely stable tool with duplex chain
- chain width approx. 22 mm, 350 mm long
- handle and chain mechanism matt chrome-plated
- retention claw prevents any slipping through
- jointed handle, can be pivoted through 180° at the side
- easy to use thanks to special chain lock



### Description

Universal

### Part no.

**08315SB**

## Oil filter chain key



with handle, 100 mm span width



### Description

Universal

### Part no.

**08420SB**

## Oil filter strap key



- with rubberised textile strap
- strap length 460 mm



① insulated handle

### Part no.

**04000L**

## Nylon oil filter strap wrench



solid implementation, completely slide-off secure, also on oil filter cartouches in the NFZ and construction machine sector

- approx. 50 mm bandwidth
- approx. 225 mm clamping area, alternatively with 10 mm (3/8") + 12.5 mm (1/2") square socket
- usable for rotating right and left



### Part no.

**08320SB**





## Oil filter key

universal, with metal strap,  
diameter from 65 - 105 mm

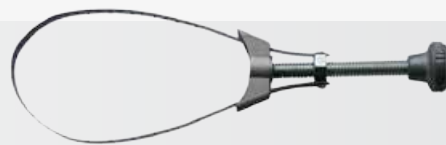

Description	Part no.
Complete key	08425SB
Replacement strap	08426L

## Oil filter pliers

3-stage oil filter pliers that require little room in the engine compartment.

Even oil filters that are difficult to reach and extremely tight are easy to loosen with this tool, making work much easier.



- suitable for passenger cars, light trucks, tractors
- no slipping off during filter change
- extra strong design with non-slip coating
- forged version

Description	Length	Part no.
Clamping width 60 - 90 mm	250 mm	08435L
Clamping width 80 - 120 mm	400 mm	08438L

## Oil filter cartridge inserts, Hexagonal

for mounting the oil filter cover when replacing the filter insert in the sizes 27 - 32 - 36 mm, e.g. for

- 27 mm spanner size: Mercedes-Benz type 168 (A-Class), Smart, Ford Fiesta 1.4 + 1.6 TDCI, Mazda 2 and 3 with 1.4 + 1.5 l diesel engines
- 32 mm spanner size: Opel Astra + Corsa Motorcode X10XE / X12XE / Y17DT / Y17DTL, VW- Passat, Polo 1.2 l from model year '05; VW T5 1.9 D from model year '04, Audi A6 3.2 l TSI, V6 from model year '04, Škoda Superb, Mercedes-Benz LKW Motorcode OM364 / OM366
- 36 mm spanner size: Mercedes-Benz C220 D, E220 D – OM604, C250D, E250D- OM605, E300D – OM606, MB Transporter OM616 engine, BMW M 52 6 cyl., 3-Series from model year '9/95, 5-Series from model year '11/95, M60/M62 – 8 cyl. 5-Series, 7-Series, 8-Series, M70/M73 – 12 cyl. 7-Series, 8-Series, Opel Vectra B DI 16V, VW T5 2.5 D, 5 cyl. From model year '04, VW-Lupo 1.2 TDI, model year '99, VW Touareg TDI, Mini One, Cooper, Cooper S



Opel  
BMW  
Mercedes-Benz  
VW  
Audi  
Mercedes-Benz LKW  
Škoda  
Mazda  
Mini  
Smart

Description	Profile	Part no.
3-piece	●	08440L

## Oil filter bell set

made of metal, with 28 bells for almost all filters as well as an oil filter spider and with a choice of the following seats

- 10 mm (3/8") drive
- 12.5 mm (1/2") drive
- outer hexagon



Description	Part no.
Universal, 30-piece	08460L
36 mm, 6 edges (Mercedes-Benz LKW, Scania)	08460-36/6
84 mm, 14 edges (MB Sprinter, Viano)	08460-84/14

## Oil filter cover set

suitable for motorbikes, 10 mm (3/8") drive.

- 65 mm / 14 edges
- 68 mm / 14 edges
- 76 mm / 8 edges (BMW, Ducati, Moto-Guzzi, Harley Davidson)
- 76 mm / 12 edges
- 76 mm / 14 edges (BMW, Harley Davidson, Champion, Champ Lee, Purolator, Mopar)
- 80 mm / 15 edges (Kawasaki)

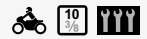

**Kawasaki**  
**Suzuki**  
**BMW**  
**Harley Davidson**  
**Ducati**



**Description**  
6-piece

**Part no.**  
**08463L**

## Oil filter bell set

made of light alloy, with 12.5 mm (1/2") drive and 27 mm outer hexagon and loosening key.

- 1 ratchet wrench 12,5 mm (1/2")
- 1 ring spanner 27 mm
- 21 oil filter bells in the following sizes:
  - 65 mm x 14 edges
  - 67 mm x 14 edges
  - 73 mm x 14 edges
  - 73 mm x 15 edges
  - 74 mm x 8 edges
  - 74 mm x 14 edges (depth 20 mm)
  - 74 mm x 14 edges (depth 27,5 mm)
  - 74 mm x 15 edges (depth 20 mm)
  - 74 mm x 15 edges (depth 27,5 mm)
  - 75 mm x 12 edges
  - 75 mm x 15 edges
  - 76 mm x 12 edges
  - 79 mm x 15 edges
  - 80 mm x 15 edges
  - 84 mm x 18 edges
  - 89 mm x 15 edges
  - 90 mm x 15 edges
  - 91 mm x 15 edges
  - 92 mm x 15 edges
  - 95 mm x 15 edges
  - 101 mm x 15 edges



**Alfa Romeo**  
**Audi**  
**Austin**  
**BMW**  
**Chrysler**  
**Citroën**  
**Daihatsu**  
**Fiat**  
**Ford**  
**General Motors**  
**Honda**  
**Lancia**  
**Mazda**  
**Mitsubishi**  
**Nissan**  
**Opel**  
**Peugeot**  
**Renault**  
**Toyota**  
**VW**



**Description**  
Universal, 23-piece

**Part no.**  
**08450L**

## Oil filter cover

made of light alloy, with 10 mm (3/8") drive and 27 mm outer hexagon.



**Toyota**

**Description**

**Part no.**

64,5 mm, 14 edges with additional recesses for Toyota 1.8l and 2.0l 4 cyl. engines in Toyota Auris, Corolla, Premio and Prius

**08452L**

64,5 mm, 14 edges with additional recesses for Toyota V6 engines ('07-'08) / Lexus – ES350 – GS350 – GS450h – LS460 – RX350 (ab '07) – LS600hL (ab '08)

**08453L**



## Oil filter hood

made of metal, 76 mm, 6 grooves  
with 12.5 mm (1/2") drive 24 mm hex



BMW  
Audi  
Citroën  
Fiat  
Ford  
Honda  
Mercedes-Benz  
Opel  
Peugeot  
Renault  
Seat  
Škoda  
Suzuki  
Volvo  
VW

- Audi A3, A4, A6
- BMW motorcycles, new model series F650 GS, F800 GS, F800 R, F800ST, F800S, R1200 GS, R1200 R, R1200 RT, K1200 S, K1200 R, K1200 GT, K1300 S, K1300 R, K1300 GT
- Citroën C5, Xantia
- Fiat Brava, Bravo, Punto, Tipo
- Ford Fiesta, Escort
- Mercedes-Benz personal vehicles and Sprinter
- Peugeot 106, 206, 306, 406
- Renault Clio, Kangoo, Megane, Laguna, Rapid
- Honda Accord, Civic, Prelude, CRX
- Opel Astra G/F, Corsa A/B, Calibra, Zafira, Frontera
- Suzuki Grand Vitara 1.9 model '09
- VW Golf III & IV, Polo, Passat, Sharan
- Seat Alhambra, Toledo, Leon, Cordoba
- Škoda Octavia
- Also suitable for fuel filters in the Renault Espace, Laguna, R19
- Volvo S40, V40 up to '99



### Description

### Part no.

76 mm, 6 rills (Audi, BMW, Citroën, Fiat, Ford, MB, Peugeot, Renault, Honda, Opel, Suzuki, VW, Seat, Škoda, Volvo)

**08454L**

## Oil filter bell set

for commercial vehicles



Renault LKW  
Scania LKW  
Mercedes-Benz LKW  
MAN LKW  
Fiat LKW  
Iveco LKW  
Toyota LKW  
Volvo LKW

- sizes 36 mm, hexagon Mercedes-Benz (e.g. Axor BR 400, Atego BR 900, Actros BR 500, buses), Scania (PDE V8 engine, HP1 enginefuel filter), various oil and fuel filter housing covers
- size 74 mm, 14-edge DaiMAN (series TGM and TGL), Mercedes-Benz (e.g. Sprinter engine series 600), VW e.g. Transporter), universal use on passenger cars too, oil filter housing cover and oil filter
- size 66/67 mm, 14-edge Daihatsu, Toyota
- size 106 mm, 15-edge MAN (8-10 tonnes series L 2000), Scania (PDE engine), Fiat (Ducato 2.5 D/ TD), Iveco oil filter and fuel filter (for MAN filter Nr. W 1160)
- size 07 mm, 15-edge Volvo, Iveco, Renault, Scania oil filter and fuel filter
- size 108 mm, 15-edge Volvo, Iveco, Renault, Scania oil filter and fuel filter
- size 108 mm, 18-groove Renault Transporter (Master, Traffic 2.4l, 2.5l, 2.8l D/TD) Opel (Movano)
- Gr. 135 mm, 18-kant MAN 18-48 tonnes series F 2000, TGA, oil filter housing cover (406, 410, 414, 440, 460)



### Description

### Part no.

9-piece

**08465L**

Size 74 mm, square with 10 mm (3/8") / 21 mm hex drive

**08465L-74**

Size 107 mm, 15 edges with 10 mm (3/8") / 21 mm hex drive

**08465L-107**

Size 135 mm, octagonal with 10 mm (3/8") / 21 mm hex drive

**08465L-135**

## Oil pump

Ideal for filling, evacuating or dosing for gears, power steering, hydraulics, engine etc.

- 200 cm<sup>3</sup> (0.2 l) per stroke
- hose length ca. 300 mm, 8 mm diameter
- metal version



### Part no.

**24015L**

## Barrel pump

- for oil, anti-freeze etc. (not for fuels)
- suitable for barrels of up to 200 litres with thread seat 2" NPT
- approx. 300 ml per stroke
- telescopic pipe extendable from 450 to 860 mm



ⓘ Seal thread using Teflon tape before use!

Part no.  
24016L

## Pneumatic pump

for oil barrels, for the extraction of motor oil from barrels

- Following connection to a compressor, pressure is built up in the barrel, causing the oil to be expelled
- suitable for barrels up to 200 litres capacity
- including different hoses
- automatic interruption in operation through safety valve
- inc. extension hose for refilling or pumping off liquids under extremely cramped conditions



Description	Working pressure min./max.	Air consumption	Part no.
30 l/min output	2,1 - 6,2 bar	85 l/min	08480L

## Suction pump

For extracting diesel, heating or engine oil.

- operation via 12V car battery through crocodile clamps
- delivery rate Engine oil: 0,2 l / min.
- capacity of diesel / fuel oil: approx. 70 l / h
- extraction through the guide tube of the oil measuring rod shaft by means of an oil extraction probe with a diameter of 6 mm

The pump is not suitable for pumping out:

- water (pump drying)
- transmission oil (to viscous consistency)
- highly flammable liquids (petrol, petroleum, etc.), risk of explosion!



ⓘ Not suitable for flammable liquids!

Part no.  
08485L



## Extraction pump

for manual or pneumatic operation with 9.5 l tank, ideal for bleeding brakes and for oil extraction, suitable for day-to-day workshop use

- permits clean oil changing thanks to extraction
- suitable for motor, gear and rear axle oils as well as other non-corrosive liquids
- suction hose diameter in 9.8 - 8.0 - 6.7 - 4.5 mm for extraction through the dipstick tube
- 9.5 l tank for the collection of large amounts of oil
- suitable for oil extraction on Smart and other vehicles where oil changing is to be carried out without the use of a lifting platform
- incl. special silicon brake bleeding hose with valve for one-handed operation
- makes the bleeding of brake systems easier on all vehicles
- the built-in manual vacuum pump enables brakes to be bled without a compressed air connection being necessary



Part no.  
**24035L**

## Dipstick

for checking the oil level in VAG engines with an electronic oil sensor e.g. 2.0l TDI, 2.0l TFSI, 2.7l TDI, 3.0l TDI, 3.2l FSI.

- also suitable for checking the oil level in 3.2-litre 6-cylinder 4-valve petrol engines e.g. Audi A4, A5 from '08
- helpful after oil sensor replacement or when calibrating the gauge in the driver display
- comparable to T40178

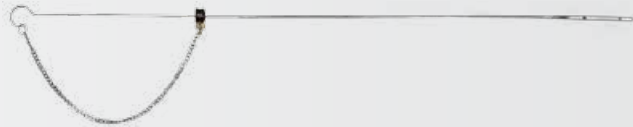

VW  
Škoda  
Seat  
Audi

Length  
625 mm

Part no.  
**03006L**

## Dipsticks

for measuring the oil level in engine and automatic gearboxes on Mercedes-Benz vehicles, always necessary after an oil change since the vehicles are delivered from the factory without dipstick, only stopper.

The amount of oil required can be found in the respective table and read off on the respective scale.

Suitable for the following engine types:

- A (length 1220 mm): for gear oil, gear code 722.6
- B (length 920 mm): for gear oil, gear code 722.7, 716.5
- C (length 930 mm): for motor oil, engine code 103.943/984/985, 104, 111, 119, 120, 137, 603.913/963/97, 604, 605, 606, 611, 612, 613, 628, 612.965
- D (length 930 mm): for motor oil, engine code M112, 113, 646, 647, 648

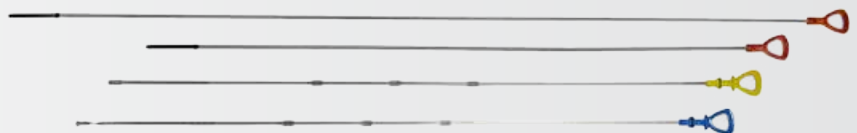

Mercedes-Benz

Description  
4-piece  
Dipstick type A

Part no.  
**03004L**  
**03004L-A**



## Ring ratchet spanner set, Double hexagon

For spots that are difficult to reach, e.g. turbocharger bolted connections etc.

- chrome-vanadium, polished
- with infinitely adjustable joint on ring spanner insert, can be angled up to 180°
- ring spanner inserts 72 teeth 8 – 9 – 10 – 11 – 12 – 13 – 14 – 15 – 16 – 17 - 18 – 19 mm
- special ratchet 48 teeth, 360° lockable



**Description**  
13-piece

**Part no.**  
**S1588**

## Turbo system force-off set



for fast diagnosis on the charging air system.

Professional time-saving troubleshooting e.g. detecting leaks in the intercooler or invisible cracks in the charge air hoses.

Multi-size adapter makes it suitable for all hoses commonly used in the charge air system. Pressure can be exerted on the part to be tested through a tyre pressure valve with conventional tyre filler (with excess pressure safety valve).

6 adapters with counterplugs each for the sizes:

- 31 / 38 mm
- 46 / 51 mm
- 55 / 60 mm
- 65 / 70 mm
- 75 / 80 mm
- 85 / 90 mm



ⓘ **Not suitable for turbocharger hoses with bayonet closure!**

**Description**  
13-piece

**Part no.**  
**26200L**





## Turbo-system force-off set



for fast diagnosis on the charging air system. Professional time-saving troubleshooting e.g. detecting leaks in the intercooler or invisible cracks in the charge air hoses and for checking the EGR valve for leaks (depending on vehicle).

Suitable for all standard hoses with bayonet lock used in charging air systems. For universal use e.g. for BMW, VAG, Mercedes-Benz, Renault, Nissan etc.

Pressure can be exerted on the part to be tested through the tyre pressure valve with conventional tyre filler (with excess pressure safety valve). The tyre filler manometer serves as a pressure loss display at the same time. In the event of pressure loss, the leak can be localised quickly and easily by gauging the section or using leak spray.

6 adapters with counterplugs each for the sizes:

- 31 mm
- 38 mm
- 46 mm
- 51 mm
- 56 mm
- 61 mm



ⓘ To be used with turbocharger hoses with bayonet lock!

Description

13-piece

Part no.

26201L

## Socket spanner insert, Double hexagon

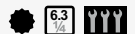

for the exchange of the vacuum-pressure adjuster in case of VAG motors with turbocharger with position sensor.

spanner AF width 10 mm, length 50 mm

- chrome - Vanadium
- with SB hanger

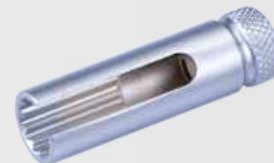

Comparable to OEM T10422A

Part no.

26157L





# GEARBOX / CLUTCH

SW-Stahl



# GEARBOX / CLUTCH

# 410-419



- ▶ Removing and Installing Gearbox 412-414
- ▶ Transmission Oil 414-417
- ▶ Other Gearbox Tools 417
- ▶ Centering Clutch Discs 417-418
- ▶ Removing and Installing SAC-Clutch 418
- ▶ Changing Spigot Bearing 418
- ▶ Other Clutch Tools 419





## Adjusting bolts set



for the exactly aligned fitting of the sub-frame.

VW  
Audi

Is required e.g. for replacement of rubber bushings as well as all work involving the removal of the sub-frame.

- VW Scirocco ('09), EOS ('06), Golf ('09), Golf Plus ('05), Jetta ('04-'06), Polo ('02), Fox ('06), Passat ('06), Passat CL ('09)
- Audi A3 ('04), TT ('07), A4 ('01)
- to be used equivalent to OEM T10096



Description  
4-piece

Part no.  
**26504L**

## Adjusting bolts set



for the exactly aligned fitting of the sub-frame.

VW

Is required e.g. for replacement of rubber bushings as well as all work involving the removal of the sub-frame.

- VW T5 since ('04)
- size: M14 x 1.5
- to be used equivalent to OE T10227



Description  
4-piece

Part no.  
**26506L**

## Engine bridge



For safe work on belts, gearboxes, etc.

- Made of stable square tubing
- For flexible widths
- Holding hooks with 16 mm threaded rods
- With rubber padding to protect the mudguards
- Chain length 900 mm
- Assembly dimensions 1010 mm to 1520 mm

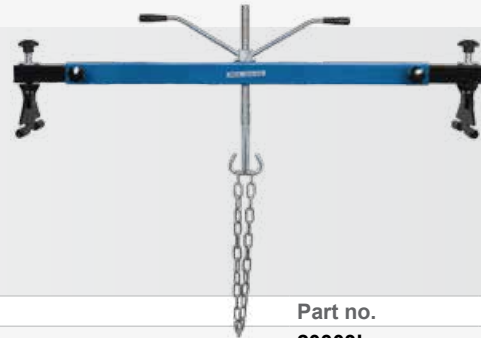

Description  
1 chain, 300 kg load capacity

Part no.  
**20303L**

## Engine bridge



for assembling and disassembling the engine and gears

- made from a stable four edged pipe
- long hole (700 mm ) for flexible width setting
- holding hook with a 20 mm threaded rod
- with rubber protectors to protect the mudguard
- chain length 900 mm
- mountable from 750 - 1.450 mm



Description  
2 chains, 500 kg load capacity

Part no.  
**20305L**

## Engine bridge



to support the engine when removing the gearbox. Suitable for  
▪ VW T5

VW

- Used equivalent to:
- VW OE no. 10-222A/23 support arms

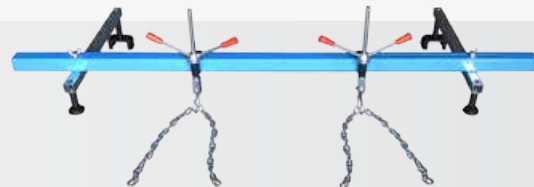

Part no.  
**20304L**

## Engine support bar

- Variable length from 630 to 960 mm

It is not possible to use typical engine bridges on many new vehicles, as the mudguards fall away at a slant or are made of plastic. The universal engine support bar provides the engine with secure support from below.



Part no.  
**26596L**

## Engine support crossmember

The universal engine support tie-bar securely holds the engine from below as soon as the side engine bearings are dismantled. The usual engine bridge is no longer required. When working on the toothed belt, water pump or auxiliary drive, a free access from above is now possible.

- the two adjustable mounting hooks securely hold the motor support beam at the vehicle floor.
- height-adjustable support plate for targeted lowering or lifting of the motor.
- the rear support arms can be positioned independently of each other by means of a hinge. Wide long holes in the arms help to find the best position for the support.
- incl. A receptacle for standard transmission drives. This means that the beam can also be installed very simply by one person.

Features:

- maximum support load: 250 kg
- variable length from 374 mm to 1,170 mm
- telescopic arm: 230 mm extendable
- support arms: pivoting 360° rotatable, 122 mm long holes

⚠ Do not use with pneumatic impact wrenches!



Part no.  
**26597L**

## Engine support bar

for pulling the engine and gearbox when exchanging the coupling or gearbox.

Suitable for:

- VW T4 (4 and 5 cylinder models)

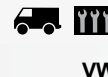

Description	Part no.
Engine support bar, for pulling the engine and gearbox	<b>20308L</b>

## Gearbox lifter

for fitting and removing gearboxes, engines, clutches

- height approx. 110 - 190 cm
- 4 casters with ball bearings
- compact design, low overall weight
- extremely large range during lifting
- fast lifting thanks to hydraulic foot pump
- piston rod: diameter 30 mm



Rated load capacity	Height min./max.	Part no.
500 kg	1100/1900 mm	<b>20309L</b>

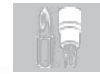



## Gearbox lifter



for the safe fitting and removing gearboxes, engines, clutches

- 4 casters with ball bearings
- Heavy-duty version
- Special deep working range
- Tilt angle and position of base plate can be adjusted
- Horizontal +/- 40 mm
- Tilt angle -10°/20°
- 420 mm support rails with support chains for safe tensioning, distance adjustable from 200 - 320 mm
- Fast lifting thanks to hydraulic foot pump
- Upper piston diameter of 29,35 mm with 35 x 1.5 mm thread for the gearbox mounting



Rated load capacity	Lifting height max.	Lifting height min.	Part no.
500 kg	1770 mm	855 mm	20307L

## Transmission Oil

### Oil filter key



for DSG transmission oil change in VAG vehicles

- short version for common rail motors
- timesaving, since no removal of the battery is necessary

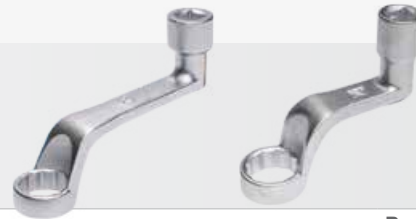

Seat  
Audi  
Škoda  
VW

Description	Part no.
Short version	08432L
Long version	08433L

### Oil service insert-bit socket, Spline with hole



XZN tripe square with hole. For gear oil control and changing on Audi A2, A3, A4 and A6 and TT as well as on VW Golf IV, Passat B5, T4 and T4 models, Škoda Fabia, Octavia, Superb, Porsche Boxster manual gearbox, Ford 1.9l TDI with 6-gear etc.



Audi  
VW  
Porsche  
Škoda  
Ford

Size	Length	Part no.
M 16	58 mm	03002L

### Oil filling hose



for VAG DSG and automatic transmissions, connection M24x1,5 mm, with mount for bolting directly to the 1-litre oil can - for controlled filling or refilling DSG transmissions Pack: bag with slide.



ⓘ Return stroke valve avoids stain while exchanging oil pulley

Description	Part no.
M24 x 1.5 mm	08475L

## Oil filler

For filling gears and differentials with oil:

- 7.5l oil tank
- hose length 160 cm
- can be used up to oil viscosity SAE 140
- extremely clean due to included return flow valve for targeted recirculation of overfilled oil in the container
- per stroke 0,07 l

with 8-piece adapter set for the following applications:

- AT 101 = FORD with thread connection
- AT 102 = BMW angled
- AT 103 = VAG short angled
- AT 104 = VAG long angled
- AT 105 = VAG short with thread connection
- AT 106 = Mercedes-Benz with 7 gear automatic transmission M12 x 1,5
- AT 107 = VAG DSG direct-shift gearbox M24 x 1,5
- AT 108 = VAG CVT continuously variable automatic M22 x 1,5



① **Extremely clean due to included return flow valve for targeted recirculation of overfilled oil in the container.**

Description	Part no.
Complete set - 8 adapter incl.	24032L
AT109 for Volvo, straight, thread connection M8 x 1,0	24036L-9
straight, with hose, thread connection M18 x 1,5	24036L-10
straight, thread connection M30 x 1,5	24036L-11
AT112 for Audi, VW with Haldex coupling 90° angled and thread connection M10 x 1	24036L-12

## Additional container

for storing gear oils of different viscosities.

- allows the use of the oil filling device with changing oils of different viscosities since only the pumping unit needs cleaning
- no tiresome refilling from the container back into the bottle
- containers can be marked, thus banishing the risk of mixing oils up
- fast access to the right oil
- cleaning agents are saved



Description	Part no.
For oil filler 24032L	24033L

## Adapter set

for oil filling device 24032L, consisting of:

- AT 106 = Mercedes-Benz with 7-speed automatic gearbox M12 x 1.5 mm
- AT 107 = VAG DSG direct shift gearbox M24 x 1.5 mm
- AT 108 = VAG CVT continuously variable automatic gearbox M22 x 1.5 mm



Description	Part no.
Additional adapter AT106, AT107, AT108	24031L

## Adapter set

for the following applications:

- AT101 = FORD with threaded connector
- AT102 = BMW angled
- AT103 = VAG short angled
- AT104 = VAG long angled
- AT105 = VAG straight with threaded connector



Description	Part no.
Additional adapter AT101, AT102, AT103, AT104, AT105	24034L



BMW  
Ford  
Audi  
Mercedes-Benz  
Seat  
VW





## Oil filling adapter

for oil filling devices 24030L and 24032L



Volvo

### Description

AT109 for Volvo, straight, thread connection M8 x 1,0

### Part no.

24036L-9

## Oil filling adapter

for oil filling devices 24030L and 24032L

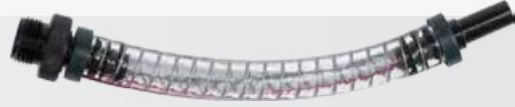

Toyota  
Lexus

### Description

straight, with hose, thread connection M18 x 1,5

### Part no.

24036L-10

## Oil filling adapter

for oil filling devices 24030L and 24032L



Seat  
Audi  
Škoda  
VW

### Description

straight, thread connection M30 x 1,5

### Part no.

24036L-11

## Oil filling adapter

for oil filling devices 24030L and 24032L.



Audi  
VW

### Description

AT112 for Audi, VW with Haldex coupling 90° angled and thread connection M10 x 1

### Part no.

24036L-12

## BMW pipe seperating pliers

Screwed clamping pliers (15 and 22 mm),  
Pliers can be spread in 5 settings by grooved  
box-joint, works similar to water pump pliers.

For removing pipes on the gear-oil cooler  
(automatic gearbox)

for BMW:

- 1 - E81, 87
- 3 - E46, 90, 91, 92, 93
- 5 - E60, 61, 63
- 6 - E64
- 7 - E65, 66
- X3 - E83
- X5 - E53, 70
- X6 - E71
- Z4/Coupé - E85, 86
- Mini R50, 52, 53, RP1

BMW OE No. 170030



BMW

### Part no.

08446L



## Dipsticks

for measuring the oil level in engine and automatic gearboxes on Mercedes-Benz vehicles, always necessary after an oil change since the vehicles are delivered from the factory without dipstick, only stopper.

The amount of oil required can be found in the respective table and read off on the respective scale. Suitable for the following engine types:

- A (length 1220 mm): for gear oil, gear code 722.6
- B (length 920 mm): for gear oil, gear code 722.7, 722.8, 716.5
- C (length 930 mm): for motor oil, engine code 103.943/984/985, 104, 111,119, 120, 137, 603.913/963/97, 604, 605, 606, 611, 612, 613, 628, 612.965
- D (length 930 mm): for motor oil, engine code M112, 113, 646, 647, 648

 Mercedes-Benz

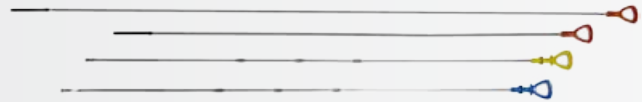

Description

4-piece

Part no.

03004L

## Dip stick Type A

for measuring the oil level in automatic gearboxes on Mercedes-Benz vehicles, always necessary after an oil change since the vehicles are delivered from the factory without dipstick, only stopper.

Suitable for the following engine types:

- A (length 1220 mm): for gear oil, gear code 722.6

 Mercedes-Benz



Part no.

03004L-A

## Other Gearbox Tools

### Pressure pad set

To renew the rubber bush on the all wheel drive gearbox for:

- BMW 3 (E46, E90), 5 (E60, E61), X1 (E84), X3 (E83), X5 (E53, E70), X6 (E71)

 BMW



Description

11-piece

Part no.

302700L

## Centering Clutch Discs

### Clutch centring tool

for perfect centring (e.g. BMW, Mercedes-Benz, Nissan, Mazda).

- 15 - 18 mm
- 20 - 26.6 mm



 Mercedes-Benz  
 Mazda  
 BMW  
 Nissan

Description

2-piece

Part no.

410150L

# Centering Clutch Discs



## Clutch centring tool

universal for passenger cars and light trucks with hubs from 15 - 28 mm. Makes the exact centring of clutch disc to clutch plate possible on vehicles without pilot bearings



- no coupling mandrels are necessary
- straightforward gearbox installation

Description  
6-piece

Part no.  
410100L

## Clutch centring tool set

universal, for vehicles with pilot bearing



- Centring bushings from 15.5 to 26.6 mm
- End bushings from 12.6 to 21.6 mm



Description  
17-piece

Part no.  
410113

# Removing and Installing SAC-Clutch

## SAC tool set



For a professional removal and installation of self-adjusting clutches with 3- or 4-hole pitch. Without this tool set, correct assembly and disassembly is almost impossible!

Fits all standard vehicles. Audi, VW, BMW, Mercedes Benz, Volvo, Opel, Renault, etc.

Audi  
VW  
BMW  
Mercedes-Benz  
Opel  
Renault  
Volvo



Description

Complete set, 34-piece  
Basic set (3-hole spacing), 29-piece  
Extension set (4-hole spacing), 5-piece

Part no.  
410110L  
410115L  
410114L

# Changing Spigot Bearing

## Inner bearing puller set



Inner bearing puller set and case

With spreader arms from 8 - 33 mm for universal use.

The impact weight makes it easier to pull out fixed bearings



Description  
11-piece

Part no.  
09665L

## DCT assembly and disassembly tool

for the assembly and disassembly of double clutches in 6-gear double clutch gearboxes (Getrag 6DCT450/ MPS6).

Material: S45C, chrome-plated

Suitable for the following vehicles:

- Volvo C30, C70 (from 06), C40 (from 04), S60 (from 11), S80 (from 07), S80L, V40 (from 13), V40 Cross Country, V50, V60, V70 (from 08), XC60
- Ford Focus (from 04), C-Max, S-Max, Galaxy, Mondeo (from 07), Kuga
- Chrysler Sebring
- Dodge Avenger, Journey

Used like the following OEM numbers:

- Volvo: 9.997.435
- Ford: 308-763



Part no.  
**410111L**



Chrysler  
Dodge  
Ford  
Volvo



## IMPACT special spanner socket, Spline

for flywheel screws e.g. Mercedes-Benz Atego



Mercedes-Benz LKW



Profile



D

M 16

Part no.

80 mm

Part no.

**410120L**

## VW/Audi fitting tool

For the professional and damage-free installation of sealing flanges with pulse generator wheel in the area of the crankshaft.

The exact positioning of the pulse generator wheel on the crankshaft is prerequisite for an exact transmitter signal and with that fault-free engine running.

Without this tool, a damage-free installation of the sealing flange is not possible.

This tool combines two tools in one, since the positioning of the pulse generator wheel is variable by means of a replaceable fixing pin.

In this way you can replace the VW tools T10134 and T10017 with one tool.



Part no.  
**94012L**



# EXHAUST





# EXHAUST

420-429



▶ Removing Exhaust

422-423

▶ Installing Exhaust Buffer

424-425

▶ Changing Lambda Sensor

425-428





## Easy-Heater



for the fast and precise heating of rusted, seized bolts and nuts or micro-encapsulated connections. Thanks to the inductive pinpoint heating, there is no need to use a welding torch which would lead to other components heating up as well. The additional generator with cooling system guarantees permanent use without unnecessary breaks.

Including 3 heating coils which can be shaped flexible and have a long service life:

- 25 mm at the side
- 20 mm vertical
- "pancake" coil



① The device fulfills the European standards!

Description	Part no.
5-piece	62100L
Lateral heating coil out of 62100L	62100L-1
Vertical heating coil out of 62100L	62100L-2
Pancake coil out of 62100L	62100L-3
Flexible heating coil out of 62100L	62100L-4
Heating coil for glow plugs for 62100L	62100L-5
Heating coil for injectors for 62100L	62100L-6

## Pneumatic angle grinder



Extra long, flat head for 100 mm grinding wheel size.

- recommended hose size 3/8"
- vibration 0.6 m/s<sup>2</sup>
- grinding wheel adapter 16 mm



① Suitable cutting disc see 9600-11

Description	Part no.
14.000 rpm.	S3268
max. 15.280 rpm.	9600-M

## Cutting wheel



for metal, cold-pressed.  
100 x 1.0 x 16 mm - suitable for pneumatic angle grinder S3268



Description	D	Heigth	Part no.
max. 15.280 rpm.	100 mm	1 mm	9600-M

## Cutting wheel



for metal, cold pressed, DSA approval, max 13,280 rpm.,  
for steel / stainless steel



Description	D	Heigth	Part no.
ONLY 1 mm thick, also for STAINLESS STEEL	115 mm	1 mm	9601-M
ONLY 1 mm thick, also for STAINLESS STEEL	125 mm	1 mm	9602-M
	178 mm	3 mm	9604-M
	230 mm	3 mm	9605-M

## Exhaust chain pipe cutter

for aluminised pipes 19 - 83 mm



Description	Part no.
Pipe cutter	10530L
Replacement chain	10545L

## Exhaust chain pipe cutter

for stainless steel pipes 35 - 85 mm, easier work through automatic clamping device



Description	Part no.
Pipe cutter	10540L
Replacement chain	10545L

## Ratchet-type pipe cutter

for exhaust pipes from ca. 28 - 64 mm, also suitable for stainless steel. Saves strength, since the pressure can be varied through the setting wheel. Indispensable when installing particulate filters



Description	Part no.
Pipe cutter	10535L
Replacement chain	10536L

## Exhaust pipe expander

Permits the widening or straightening of dented, bent or pressed exhaust tubes.



Description	Part no.
Suitable for pipe diameter 29 - 44 mm	10501L
Suitable for pipe diameter 39 - 58 mm	10502L
Suitable for pipe diameter 54 - 87 mm	10503L

## Safety tongs for exhaust clamps

Safety tongs for exhaust clamps

- for widening and holding the exhaust clamps open during exhaust replacement
- suitable for e.g.: Citroën, Peugeot and Renault
- 4 locking positions to relieve the strain on the hand
- clamps from 20 - 60 mm



Citroën  
Peugeot  
Renault

Length	Part no.
300 mm	26005L

## Exhaust spring compressor

for mounting clamping springs on the manifold of different VAG mufflers

- span width approx. 45 - 80 mm



Audi  
Seat  
Škoda  
VW

Part no.
26000SB



## Ejector tool for exhaust rubbers



- For easier dismantling of exhaust suspensions.
- 25° opening angle for sufficient space



**Length**  
285 mm

**Part no.**  
**26003L**

## Ejector tool for exhaust rubbers



large version

- Makes it easier to remove suspension rubbers
- Sufficient space thanks to 25° opening angle
- With self-centring pressure pin
- Suitable for small delivery trucks and large passenger cars



**Length**  
360 mm

**Part no.**  
**26004L**

## Hook tool

for exhaust rubber rings



**Length**  
200 mm

**Part no.**  
**10520L**

## Hook tool

for removing the retaining rubbers on exhaust systems, chrome-plated.



**Length**  
315 mm

**Part no.**  
**10505L**

## Fitting hook



Perfect for the removal and fitting of springs on brakes, headlights, motorbike mufflers and much more besides. The bent shape of the spring hook allows a free view of the fitting spot

- alloyed steel
- hardened



**Length**  
160 mm

**Part no.**  
**10515L**



## Fitting paste

for the fast, gentle and easy fitting and removal of all standard wheel/tyre combinations including run-flat tyres.

- chemically neutral to rubber and metal
- the high sliding effect during fitting and removal reduces fitting injuries
- promotes the interlocking between rim and tyre
- 100% biologically degradable
- 100% guarantee of no contact allergies for fitters
- antifreeze-safe, processing temperature from -15°C to +50°C
- very efficient
- centrifuge-resistant
- color white



Description	Part no.
3 kg bucket (Run-Flat and PAX)	<b>02130L</b>
5 kg bucket (Run-Flat and PAX)	<b>02132L</b>

## Changing Lambda Sensor

### Special socket for lambda sensors

Key width 22 mm, length 110 mm

- chrome - Vanadium
- grauated version
- with self-serice hanger

Especially for mounting lambda sensors with integrated heat protection, e.g. Ford



Ford

Part no.  
**26158L**

### Special socket for lambda sensors

extra long version, slotted, for deep-seated lambda probes, suitable for:

- BMW, Ford, Mercedes-Benz, Opel, VAG etc.



BMW  
Audi  
Ford  
Mercedes-Benz  
Opel  
VW

Description	Size	Part no.
Lambda probe special spanner	22 mm	<b>26026L</b>

### Special sets of deep spanner sockets

A special range of open and closed deep spanner sockets for use with Lambda probes in all installation positions, thermal switches for the Opel cooler unit fan as well as for Diesel injection nozzles without damaging the fuel return line. Can be used on nearly all vehicles.

Includes the following sizes:

- Hexagon size 29 x 90 mm, 12,5 mm (1/2") drive, with slot
- Hexagon size 22 x 90 mm, 10 mm (3/8") drive, with slot
- Bihexagon size 27 x 83 mm, 12,5 mm (1/2")drive, with opening
- Hexagon size 27 x 74 mm, 10 mm (3/8") drive
- Hexagon size 22 x 80 mm, 10 mm (3/8") drive, with slot
- Hexagon size 22, 10 mm (3/8") drive, angled, slotted
- Hexagon size 22, 12,5 mm (1/2"), angled, slotted

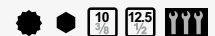

Opel  
Chrysler  
Fiat  
Ford  
Mercedes-Benz  
Seat  
Škoda  
VW

① **Universal - lambda probes / thermal switches / injection nozzles**

Description	Part no.
7-piece	<b>26045L</b>



## Lambda sensor release tool

L-form with lateral offset drive



**YYY**  
 VW  
 Škoda  
 Seat  
 Opel  
 Mercedes-Benz  
 Ford  
 Fiat  
 Chrysler

Drive	Size	Part no.
	22 mm	26045L-1
	22 mm	26045L-2

## Socket spanner bit, Hexagonal

7 mm (1/2"), slot width for 12.5 mm (1/2") drive



**YYY**

Size	Length	Part no.
29 mm	90 mm	26045L-3

## Socket spanner bit, Hexagonal

with 18 mm (3/8"), slot width for 10 mm (3/8") drive



**YYY**

Size	Length	Part no.
22 mm	90 mm	26045L-4

## Socket spanner bit, Double hexagon

closed-ended, with lateral opening for 12.5 mm (1/2") drive



**YYY**

Size	Length	Part no.
27 mm	83 mm	26045L-5

## Socket spanner bit, Hexagonal

with 8 mm (3/8"), slot width for 10 mm (3/8") drive



**YYY**

Size	Length	Part no.
22 mm	80 mm	26045L-6

## Socket spanner bit, Hexagonal

with 8 mm (3/8"), slot width for 10 mm (3/8") drive



**YYY**

Size	Length	Part no.
27 mm	74 mm	26045L-7

## Lambda probe loosening tool

10 mm (3/8") drive

e.g. VW Passat, BMW, Nissan



Nissan  
BMW  
VW  
Audi  
Citroën  
Ford  
Honda  
Mercedes-Benz  
Mitsubishi  
Opel  
Peugeot  
Renault  
Seat  
Škoda  
Suzuki  
Toyota



Description

22 mm

Part no.

26040L

## Special spanner sockets

Special assortment of open and closed spanner sockets for lambda probes in all installation positions, chrome-vanadium, burnished.

- 12.5 mm (1/2") drive:
  - 30 mm double hexagon, 80 mm long (Bosch, GM, DB)
  - 27 mm hexagon, 80 mm long (universal)
  - 28 mm double hexagon, 80 mm long (Alfa Romeo, Chrysler, Rover, MAN 2,5 TD, Volvo, Scania, HGV)
  - 21 mm double hexagon, 85 mm long (Ford, VAG)
  - 27 mm double hexagon, 85 mm long (Diesel injectors BMW M21, M41, M51-Motoren, Fiat, Ford, Peugeot, VW and Mercedes-Benz)
  - 22 mm double hexagon, 80 mm long (universal)
  - 27 mm double hexagon, 110 mm long (Citroën, Peugeot)
  - 22 mm double hexagon, 110 mm long (Audi, BMW, Mercedes-Benz, VW, Volvo)
  - 22 mm double hexagon, 150 mm long (BMW)
  - 20 mm hexagon, 80 mm long, slotted (universal)
  - 19 mm double hexagon, 80 mm long (VW, Audi, Seat)
  - 17 mm double hexagon, 80 mm long (BMW, Mercedes-Benz, Renault)
  - 22 mm double hexagon, 50 mm long, offset (universal)
- 10 mm (3/8") drive:
  - 22 mm hexagon, 30 mm long, offset (universal)



MAN  
Rover  
Chrysler  
BMW  
Alfa Romeo  
Volvo  
Scania LKW  
Renault  
Peugeot  
General Motors  
Citroën  
Audi  
Fiat  
Ford  
Mercedes-Benz  
Opel  
Seat  
Škoda  
VW



① universal - lambda probes / thermal switches / injection nozzles

Description

14-piece

Part no.

26042L



## Easy-Heater



for the fast and precise heating of rusted, seized bolts and nuts or micro-encapsulated connections. Thanks to the inductive pinpoint heating, there is no need to use a welding torch which would lead to other components heating up as well. The additional generator with cooling system guarantees permanent use without unnecessary breaks.

**Including 3 heating coils which can be shaped flexible and have a long service life:**

- 25 mm at the side
- 20 mm vertical
- "pancake" coil



① **The device fulfills the European standards!**

Description	Part no.
5-piece	62100L
Lateral heating coil out of 62100L	62100L-1
Vertical heating coil out of 62100L	62100L-2
Pancake coil out of 62100L	62100L-3
Flexible heating coil for 62100L	62100L-4
Heating coil for glow plugs for 62100L	62100L-5
Heating coil for injectors for 62100L	62100L-6

## Lambda probe thread repair tap



for cleaning and re-cutting. 10 mm (3/8") inner hexagon or 19 mm outer hexagon drive



Description	Part no.
M18 x 1.5	26041L

## Lambda probe thread repair set



universal for all vehicles, comprising a lambda probe socket, HSS twist drill, inserting tool for the self-cutting repair inserts and 5 inserts.

- Internal thread M18 x 1.5 mm



① **Please note: The fit between drill and threaded sleeve is very small (21.0 mm to 21.5 mm). Therefore, the drill hole must be made very precisely and absolutely vertically.**

Description	Part no.
8-piece	26055L
HSS spiral drill for lambda probe - 21 mm	26050L-1
Lambda probe special spanner - 22 mm	26050L-2
Screw-in tool	26050L-3
Threaded insert for lambda probes	26050L-4



# AIR CONDITION





# AIR CONDITION

430-433



▶ Measuring Air Temperature

432

▶ Removing and Installing air condition pipes

432-433





## Digital infrared thermometer



With laser pointer, automatic shutdown, illuminated digital display, ideal for measurements on hot or rotating parts, liquids or spots that are difficult to reach.

- measuring range -50 to + 550°C
- measuring accuracy ± 2,5 %
- operating temperature: 0° - 50°C
- distance factor 12 : 1
- switchable °F / °C
- incl. 2x AAA battery



Part no.  
72360L

## Removing and Installing air condition pipes

### Dryer cartridge cap remover



an ideal tool for removing the cap on the dryer cartridge.

- for universal use with caps that have a 5 mm inner thread

Suitable for vehicles with a new condenser whose dryer is positioned inside the unit, e.g. VW, Audi, Škoda, Seat, Opel, Ford, etc.



Part no.  
26202L

### Line connector loosening clip set



for quick-release couplings on air-conditioning systems and fuel lines with line diameters 1/4", 5/16", 3/8", 1/2", 5/8", 3/4", 7/8"



Daihatsu  
Honda  
Mitsubishi  
Nissan  
Scania LKW  
Volvo

Description  
7-piece

Part no.  
61716L

### Line connector loosening set



for opening line couplings on air-conditioning systems, fuel, air and oil lines with diameter 5/16", 3/8", 1/2", 5/8", 3/4", 7/8".  
Universal range - suitable for all standard vehicles



Description  
22-piece

Part no.  
61717L



## Air conditioner tool set

6.3 1/4



contains all tools for fittings on air conditioning systems

- 2 special sockets for 2.2 and 3.2 mm for fixed throttles
- 2 special 8-sided sockets 12 and 15 mm (Volvo)
- bit adapter and 5-star bits IP10, 15, 20, 25, 27, 30, 40 with hole to loosen flanges e.g.
- all tools with 6.3 mm (1/4") drive



Description

12-piece

Part no.

61719L

## Sealing stopper set



prevents liquids escaping e.g. from brake, fuel and power steering lines and prevents soiling entering air-conditioning systems.

Contains:

- two sealing clips for (banjo) hollow bolts and pipe connections
- three sealing plugs for inner diameter 5-6.3-8 mm

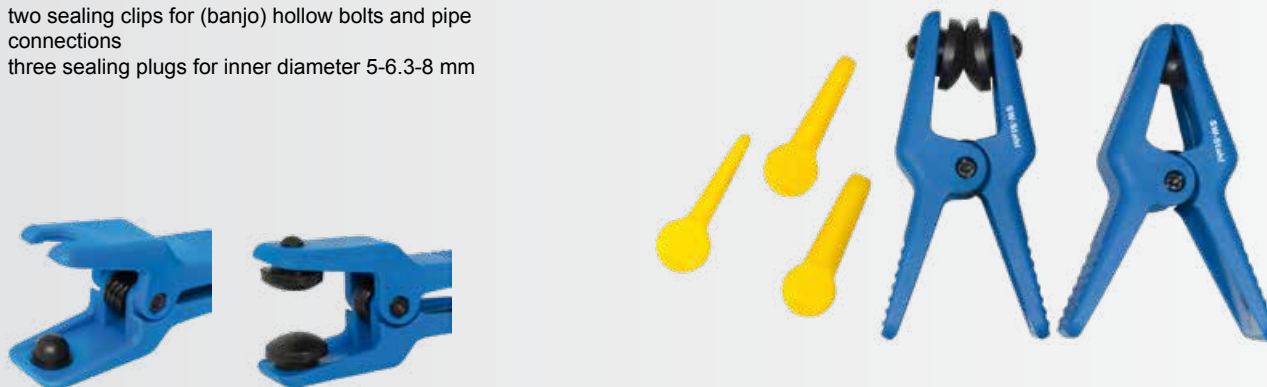

Description

5-piece

Part no.

61706L

## Sealing stopper set



prevents liquids escaping e.g. for brake fluid, oil and fuel etc. and prevents soiling entering air-conditioning systems.

Suitable for (banjo) hollow bolts and pipe connections with an inner diameter of 8-10-13 mm.



Description

8-piece

Part no.

61707L



# STEERING / SUSPENSION

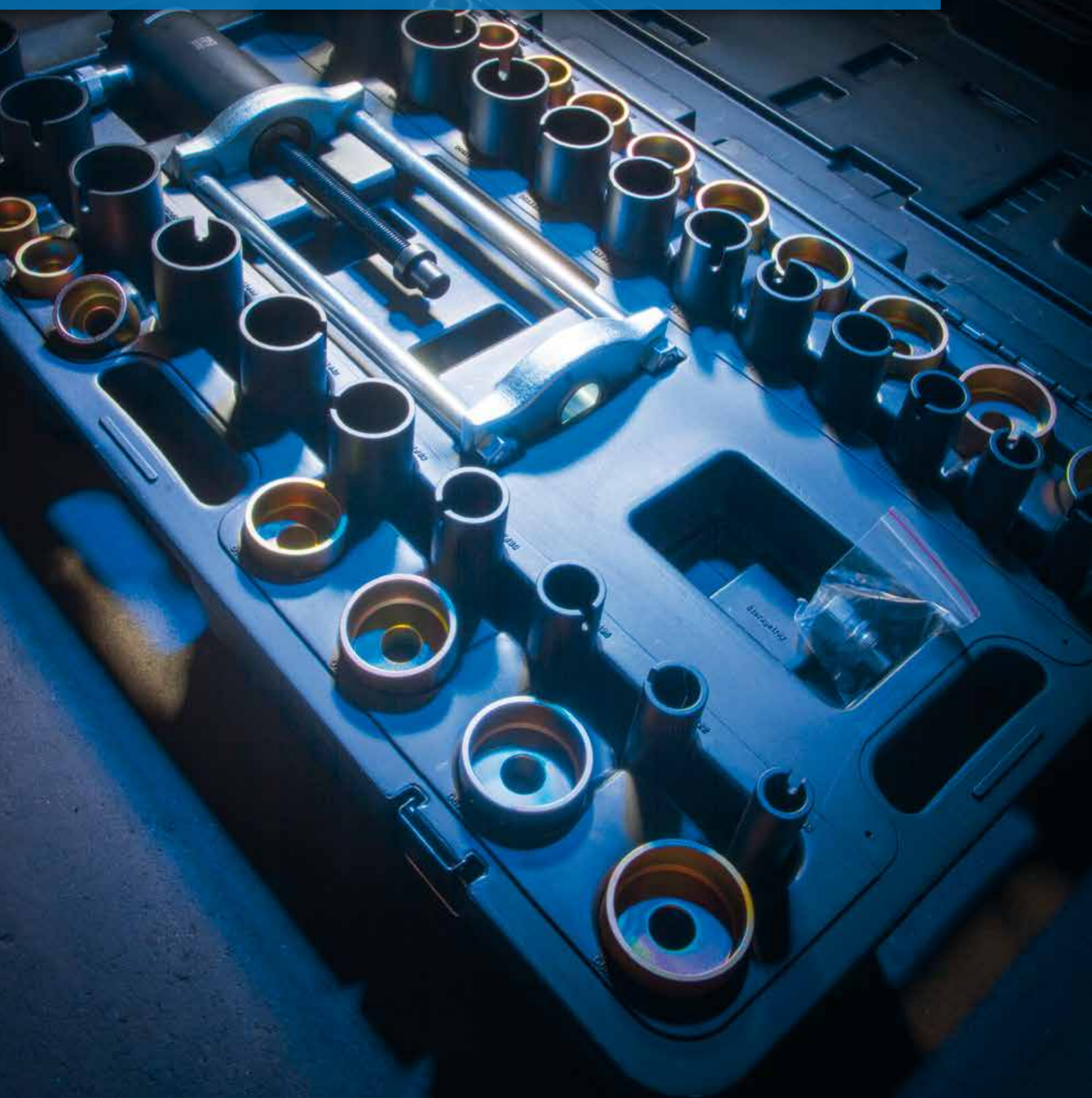

# **STEERING / SUSPENSION** **434-501**



- ▶ **Universal Tools** 436-441
- ▶ **Ball Joint Tools** 441-451
- ▶ **Front Suspension Bushes** 451-461
- ▶ **Rear Suspension Bushes** 462-474
- ▶ **Wheel Bearings** 475-481
- ▶ **Wheel Hubs** 481-482
- ▶ **Drive Shafts** 482-490
- ▶ **Steering / Tie Rods** 490-493
- ▶ **Shock Absorber** 493-501





## SAUER Drive Set, Hydraulic



This basic set is used as a hydraulic drive for almost all tensioning and press work on wheel bearings, drive shafts, rubber bearings and supporting joints. In combination with the Sauer press frames or the Sauer pressure pieces, this set is a must for any workshop.



Description	Part no.
drive set, hydraulic	80220033
Hydraulic cylinder	80210000
M12 x 450 mm feed shaft, with nut	80220007
M14 x 450 mm feed shaft, with nut	80220010
M20 x 450 mm feed shaft, with nut	80220025
450 mm pressure spindle	80220059
Adapter with $\varnothing$ 30 mm socket	80220046
Adapter with $\varnothing$ 35 mm socket	81200096
For vehicle pressure pieces	80220003
Pressure mandrel, 100 mm	81200097
Pressure mandrel, 25 mm	81200098

## SAUER Basic Set with Press Frame



With universal press frame in closed design and 20 t hydraulic cylinder. Designed to fit universal pressure and support sleeves with 30 mm connectors.



Description	Part no.
Basic set	81230500
Hydraulic cylinder	80210000
Press frame, closed design	80220047
450 mm pressure spindle	80220059
Pressure mandrel, 25 mm	81200098

## SAUER Basic Set with Press Frame



With press frame for vehicle pressure and support sleeves and 20 t hydraulic cylinder.



Description	Part no.
Basic set	81230600
Hydraulic cylinder	80210000
Press frame, opened design	80220032
450 mm pressure spindle	80220059
Pressure mandrel, 25 mm	81200098

## SAUER Pressure and Support Sleeve Set, $\varnothing$ 18–78 mm



Universal pressure and support sleeve set with internal diameters of 18 to 78 mm and lengths of 40 mm, 100 mm, and 120 mm.

Ideal for removing and installing rubber bearings and supporting joints.

54-piece

Contents:

- Pressure and support sleeves,  $\varnothing$  18–78 mm, length 40 mm
- Pressure and support sleeves,  $\varnothing$  26–70 mm, length 100 mm
- Pressure/support sleeves  $\varnothing$  72–78 mm, length 120 mm



Description	Part no.
Pressure and support sleeve set, $\varnothing$ 18 – 78 mm	81230200





## SAUER Pressure and Support Sleeve Set, ø 30–90 mm



Comprehensive universal set for removing and installing rubber bearings and supporting joints.

31-piece

Contents:

- Pressure and support sleeves, ø 30–70 mm, length 100 mm
- Pressure and support sleeves, ø 72–90 mm, length 120 mm

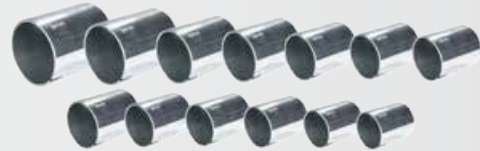

Description	Part no.
Pressure piece set, long, ø 30 - 90 mm	81231100

## SAUER Pressing Clamp Set



The Sauer pressing clamp is designed for work directly on the vehicle and can be operated both manually and hydraulically.

Description:

Internal length: 230 mm  
 Socket thread 1: M42 × 2.0  
 Socket thread 2: M42 × 2.0  
 Max. load: 12 tonnes  
 Weight: 6.6 kg



Description	Part no.
Pressing clamp set	81230300
Pressing clamp, single	81230301
Threaded sleeve	80220036
Drive set, manuell	81230400

## SAUER Drive Set, manual



This basic set contains almost all components for manual tensioning and pressing work on wheel bearings, drive shafts, rubber bearings and supporting joints. The trapezoid thread used ensures long-term durability even under the highest loads. Naturally, the set perfectly matches the Sauer pressure and support sleeve sets, press frames, and pressing clamps.



Description	Part no.
Drive set, manuell	81231400
TR10x350 feed shaft	80220054
TR12x350 feed shaft	80220055
TR14x350 feed shaft	80220056
TR16x350 feed shaft	80220057
TR18x350 feed shaft	80220058
TR10 nut	80220062
TR12 nut	80220063
TR14 nut	80220064
TR16 nut	80220065
TR18 nut	80220066
Bearing adapter	80220061
Pressure spindle and feed shaft TR20x450	81230401
Socket adapter	81230403
Adapter TR20 to M42	81230402
Adapter TR20 to 2 1/4"-14	81230404
TR20 nut	81230405

## SAUER Drive Set, manual

This drive set is designed for the manual changing of rubber bearings for axle suspension parts. Naturally, the set perfectly matches the Sauer pressure and support sleeve sets.



Description	Part no.
Drive set, manuell	81231500
TR10x350 feed shaft	80220054
TR12x350 feed shaft	80220055
TR14x350 feed shaft	80220056
TR16x350 feed shaft	80220057
TR18x350 feed shaft	80220058
TR10 nut	80220062
TR12 nut	80220063
TR14 nut	80220064
TR16 nut	80220065
TR18 nut	80220066
Bearing adapter	80220061

## Silent bearing/supporting joint tool set

for pressing in/out of supporting joints or silent bearings with 18.2 t hydraulic cylinder, pressing frame and pressure pieces in various sizes. 44 pressure pieces with diameters from (A/I) 26 x 18 mm to 68 x 60 mm and lengths from 40 mm to 100 mm.



① Complete set with 18,2 t hydraulic spindle and pressure piece.

Part no.  
302100L

## Silent bearing/supporting joint tool set

with additional pressing frame and pressure pieces in various sizes. 44 pressure pieces, 40 and 100 mm long, with diameters from (A/I) 26 x 18 mm to 68 x 60 mm.



① Complete set with 10 t hydraulic spindle and pressure piece.

Part no.  
302102L

## Silent bearing/supporting joint tool set

with additional pressure pieces in various sizes. 44 pressure pieces, 40 and 100 mm long, with diameters from (A/I) 26 x 18 mm to 68 x 60 mm.



Part no.  
302103L



## Silent bearing / ball joint tool set



Uses pressure pieces in different sizes to press ball joints and silent bearings in and out.

44 pressure pieces with a diameter of (E/I) 26 x 18 mm to 68 x 60 mm and a length of 40 mm and 100 mm.



Description	Part no.
44-piece	302106L

## Tension / thrust sleeve set



For the removal and retraction of silent bearings, hydraulic bearings, bushings, ball bearings, rubber bearings, etc. to passenger cars and commercial vehicles. Also to be used for rubber bushes and radial sealing rings

- slightly supported by industrial ball bearing on the spindle nut
- four spindles in 350 mm length, M10, M12, M14 and M16
- eight pressure nuts with bearing: M10, M12, M14, M16
- 20 pressure pieces, slit for visual inspection
- can also be used with a workshop press or press frame

Dimensions of the sleeves:  
Outer Ø Inner Ø [mm] Height inside - 50 mm

- 44/34 - 46/36 - 48/38 - 50/40 - 52/42 - 54/44 - 56/46 - 58/48 - 60/50 - 62/52
- 64/54 - 66/56 - 68/58 - 70/60 - 72/62 - 74/64 - 76/66 - 78/68 - 80/70 - 82/72



ⓘ Trapezoidal thread for high loads!

Description	Part no.
32-piece	10032L
Tr10 x 2.0 spindle	10032L-2
Tr12 x 2.0 spindle	10032L-3
Tr14 x 2.5 spindle	10032L-4
Tr16 x 3.0 spindle	10032L-5
M18 x 1.5 spindle	10032L-6

## Spindle



incl. two pressure nuts  
for puller and pusher sleeve set 10032L

ⓘ Trapezoidal thread for high loads!



Description	Part no.
Tr10 x 2.0 spindle	10032L-2
Tr12 x 2.0 spindle	10032L-3
Tr14 x 2.5 spindle	10032L-4
Tr16 x 3.0 spindle	10032L-5
M18 x 1.5 spindle	10032L-6

## Pressure piece



from the set 10032L



Diameter	Length	Part no.
76/66	75,8 mm	10032L-7
80/70	80 mm	10032L-8
82/72	80 mm	10032L-9



## Pressing clamp



For the removal and retraction of silent bearings, hydraulic bearings, bushings, ball bearings, rubber bearings, etc. to passenger cars and commercial vehicles.



① To be used with 10032L tension /thrust sleeve set and with 09681L hydraulic spindle 12 t!

Description	Part no.
220 mm clamping range	10032L-1

## Hydraulic foot-operated pump



ideal for actuating the hollow piston cylinder. Acts as a "third hand" at work. In contrast to working with hand pumps, both hands are free and do not require a second fitter. Two-stage.



- 1st stage up to 13.8 bar maximum pressure
- 2nd stage up to 700 bar maximum pressure
- Complete with 3/8" NPT connection (301137L) and 2.50 m hose

Part no.  
301120L

## SAUER Aluminium Hydraulic Foot Pump, 700 bar



Small but powerful aluminium foot pump for operating the Sauer hydraulic cylinder incl. pressure gauge and high-pressure hydraulic hose. The low weight makes the pump very handy. Unlike with hand pumps, it leaves both hands free to operate the tool or cylinder.



Description:

- Aluminium hydraulic foot pump
- Incl. glycerine-filled pressure gauge
- Incl. high-pressure hydraulic hose with quick coupling, 2.50 metres
- Max. pressure: 700 bar
- Weight: 5.5 kg
- Dimensions without hose: 400 × 200 × 150 mm (L × W × H)

Description	Part no.
Hydraulic foot pump	80210100
Storage case	80210103
Replacement pressure gauge	80210101
Replacement hydraulic hose	80210102

## Ball Joint Tools

### SAUER Aluminium Hydraulic Foot Pump, 700 bar



Small but powerful aluminium foot pump for operating the Sauer hydraulic cylinder incl. pressure gauge and high-pressure hydraulic hose. The low weight makes the pump very handy. Unlike with hand pumps, it leaves both hands free to operate the tool or cylinder.



Description:

- Aluminium hydraulic foot pump
- Incl. glycerine-filled pressure gauge
- Incl. high-pressure hydraulic hose with quick coupling, 2.50 metres
- Max. pressure: 700 bar
- Weight: 5.5 kg
- Dimensions without hose: 400 × 200 × 150 mm (L × W × H)

① Complete set with 18,2 t hydraulic spindle and pressure piece.

Part no.  
302100L



## Pressure piece set

20 pressure pieces with diameters from (A/I) 70 x 60 mm to 88 x 80 mm and lengths from 40 mm to 110 mm.



① Ideal complement for article 302100L / 302102L / 302103L

Part no.  
302101L

## Silent bearing/supporting joint tool set

with additional pressing frame and pressure pieces in various sizes. 44 pressure pieces, 40 and 100 mm long, with diameters from (A/I) 26 x 18 mm to 68 x 60 mm.



① Complete set with 10 t hydraulic spindle and pressure piece.

Part no.  
302102L

## Silent bearing/supporting joint tool set

with additional pressure pieces in various sizes. 44 pressure pieces, 40 and 100 mm long, with diameters from (A/I) 26 x 18 mm to 68 x 60 mm.



Part no.  
302103L

## Pressing clamp

For the removal and retraction of silent bearings, hydraulic bearings, bushings, ball bearings, rubber bearings, etc. to passenger cars and commercial vehicles.



① To be used with 10032L tension /thrust sleeve set and with 09681L hydraulic spindle 12 t!

Description  
220 mm clamping range

Part no.  
10032L-1

## Tension / thrust sleeve set

For the removal and retraction of silent bearings, hydraulic bearings, bushings, ball bearings, rubber bearings, etc. to passenger cars and commercial vehicles. Also to be used for rubber bushes and radial sealing rings

- slightly supported by industrial ball bearing on the spindle nut
- four spindles in 350 mm length, M10, M12, M14 and M16
- eight pressure nuts with bearing: M10, M12, M14, M16
- 20 pressure pieces, slit for visual inspection
- can also be used with a workshop press or press frame

### Dimensions of the sleeves:

Outer Ø Inner Ø [mm] Height inside - 50 mm

- 44/34 - 46/36 - 48/38 - 50/40 - 52/42 - 54/44 - 56/46 - 58/48 - 60/50 - 62/52
- 64/54 - 66/56 - 68/58 - 70/60 - 72/62 - 74/64 - 76/66 - 78/68 - 80/70 - 82/72

① Trapezoidal thread for high loads!



Description	Part no.
32-piece	10032L
Tr10 x 2.0 spindle	10032L-2
Tr12 x 2.0 spindle	10032L-3
Tr14 x 2.5 spindle	10032L-4
Tr16 x 3.0 spindle	10032L-5
M18 x 1.5 spindle	10032L-6

## Separating and mounting fork

for tie-rod ends and steering columns



Size	Length	Part no.
17 mm	400 mm	10101L

## Separating and mounting fork set

with three different fork sizes, with adapter for impact and pneumatic chisel hammer.

Fork openings 70 x 18 mm - 70 x 25 mm - 70 x 28 mm



① Can be used with S3211!

Description	Part no.
5-piece	10100L

## Ball-joint extractor

For removing the ball joints from the steering knuckle, e.g. Steering rod, stabilizer and the like.

- clamping height up to 50 mm
- fork opening 20 mm



Description	Part no.
Short fork, fine thread spindle	10005L
Long fork, fine thread spindle	10006L





## Ball-joint remover

for pushing the ball pin out when removing ball joints from the stabiliser, steering knuckle, steering lever etc.

- Clamping range up to 55 mm
- Width 22 mm



- 
- Audi
- BMW
- Fiat
- Ford
- Mercedes-Benz
- Nissan
- Opel
- Peugeot
- Renault
- Rover
- Saab
- Seat
- Škoda
- Toyota
- Volvo
- VW

Description	Part no.
Clamping range can be adjusted in 2 fixed stages, 30 + 55 mm, with fine thread spindle	10008L

## Ball-joint remover

Extra large, forged, universally applicable for trucks. The fork extension serves to drive the tool with a targeted hammer strike.

- Fork opening 20 mm



Description	Part no.
Extra large with fork extension	10007L

## Ball-joint remover set

with fine-thread spindles

- E23 x H55
- E28 x H55
- E34 x H63



- 

- Mercedes-Benz
- VW
- Audi
- Fiat

ⓘ Especially suitable under cramped conditions

Description	Part no.
3-piece	10015L
23 mm wide, 55 mm useful height, for almost all passenger cars, particularly BMW E39 and MB W210	10010L
28 mm wide, 55 mm useful height especially for Audi A4, A6, A8, VW Passat etc., Opel Movano, MB W203	10011L
34 mm wide, 63 mm useful height especially for VW "LT" from model year '96, VW "T4", Mercedes-Benz Sprinter from model year '95, Fiat Ducato usw.	10012L

## Ball joint remover set

with interchangeable fork system, allows disassembly of ball joints in various sizes.

- Suitable for cars, light trucks and SUVs
- 5 interchangeable forks 20-22-24-27-30 mm
- Max. extractor width 125 mm



ⓘ Heavy duty version

Description	Part no.
6-piece	10019L

## Ball-joint remover

for universal use with trucks/commercial vehicles

- with two seats 24 + 32 mm width
- with oil hydraulic spindle for easy and fast work
- clamping range: 55 - 105 mm

ⓘ **Warning: Clean and lubricate the screw with grease (MOS2), before using it.**



Description	Part no.
24 + 32 mm width	10004L

## Pry bar set

Pry bar for all applications in the truck and agricultural vehicles sector. With plastic soft grip, single-piece blade and impact cap. Ideal for supporting joints, bearing and separating work. High-strength version.

- 900 mm straight
- 900 mm 45° angled
- 600 mm 75° angled
- 600 mm 90° angled



Description	Part no.
4-piece	10104L

## Pry bar set

For separating and mortice work e.g. on steering tie rods and joints, for testing faulty bearings etc.



Description	Part no.
4-piece, 200, 300, 450, 600 mm	10105L

## Wishbone lever tool

facilitates the removal of wishbones from the wheel bearing housing. Also very useful when installing pre-tensioned wishbones.

The lever tool is attached to the vehicle floor and the wishbone using strong metal hooks attached to chains. Rotating the spindle exerts a tensile force on the wishbone.



Part no.
10048L

## Stub axle lifter

- facilitates the removal of transverse link braces from the wheel bearing housing
- also very useful when installing pre-tensioned cross-braces
- support adjustable in 3 positions
- neoprene handle



ⓘ **New enhanced version!**

Length	Part no.
1225 mm	10135L



## Bow-type hook

with joint, a fast problem-solver e.g. when removing wishbones.  
The joint provides additional hanging flexibility.



Description	Thread	Part no.
Bow type hook with joint	M 16 x 1,5	10020L
Bow type hook		10022L
Joint	M 16 x 1,5	10028L

## Practi-hook

forged, for universal use for many alignment and pulling jobs



Part no.  
10021L

## Articulation piece

To connect Practi bow-type and universal hooks or hangers using a slide hammer from 10107L.



Description	Thread	Part no.
Joint	M 16 x 1,5	10028L
Joint	M 20 x 1,5	10029L

## Push-out attachment

for pushing out the safety screw on the upper wishbone on the wheel bearing housing strut.  
In conjunction with the vibro-pneumatic chisel e.g. S3211 or S3213 the screw is pushed out through the aluminium axle shaft by means of vibration blows. This keeps the time required to a minimum, and the axle shaft no longer needs to be heated. The guide sleeve included in the set is used to direct the vibration blows cleanly onto the safety screw.

- suitable for: Audi A4, A6, A8, Seat Exeo, VW Passat
- for chisel shaft: Ø 10 mm round

ⓘ Suitable for S3211 and S3213



Audi  
Seat  
VW

Description	Part no.
3-piece	S3211-2

## Tool set

For 4-link aluminum axles, to push out the locking screw at the upper suspension arms at the wheel bearing housing. The locking screw is released by pressure, not by impact.

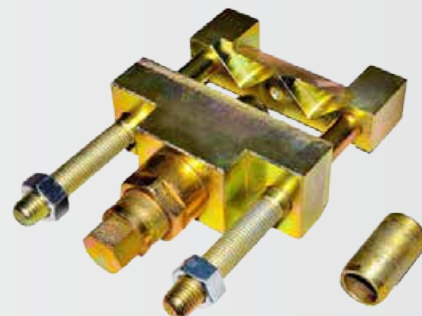

Part no.  
302435L

## Ball joint tool

for loosening and turning of tightly fixed ball joints

Suitable for Audi A4 / A5 / A6 / A7 / Q5



Audi



Part no.  
10049L

## Ball joint tool

for replacing the upper ball joints in the VW T4.



VW

Description  
7-piece

Part no.  
302401L

## Pressure piece set

for upper front axle ball joints (46 mm diameter)

- Opel (Vauxhall) Movano from '98
- Nissan Interstar from '02
- Renault Master from '98
- VW T4 '90-'03

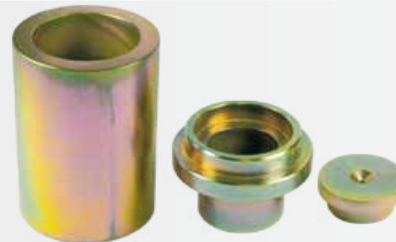

VW  
Nissan  
Opel  
Renault

① Only in combination with press frame

Description  
Pressure Pad

Part no.  
301266L  
301267L

5-piece, Pressing frame mechanical

## Ball joint tool set

to replace the ball joints with a press frame and 20 pressure pieces.

For the upper ball joint on

- VW T4, Crafter
- Mercedes-Benz Sprinter
- Renault Master
- Opel Movano
- Nissan Interstar

For the lower ball joint on

- VW LT, Mercedes-Benz Sprinter
- Renault Master from '06
- Opel Movano
- Nissan Interstar
- Iveco



Nissan  
Renault  
Iveco  
Mercedes-Benz  
Opel  
VW

Description  
21-piece

Part no.  
302406L



## Ball joint tool set

to replace the ball joints with press frame and 10 pressure pieces.

For the upper ball joint on

- VW T4
- Renault Master
- Opel Movano
- Nissan Interstar

For the lower ball joint on

- VW LT
- Mercedes-Benz Sprinter



Opel  
 Nissan  
 Renault  
 VW  
 Mercedes-Benz

**Description**  
 11-piece

**Part no.**  
 302407L

## Ball joint tool set

to replace the ball joints with a press frame and 6 pressure pieces.

For the upper ball joint on

- VW T4

For the lower ball joint on

- VW LT
- Mercedes-Benz Sprinter



VW  
 Mercedes-Benz

**Description**  
 7-piece

**Part no.**  
 302411L

## Pressure piece

for 302411L to dismantle ball joints for

- VW Crafter
- Mercedes-Benz Sprinter 906



VW  
 Mercedes-Benz

**Part no.**  
 302412L

## Ball-joint remover

for pressing the ball joint cone out of from the stub axle in Mercedes-Benz Sprinter and VW LT.



Mercedes-Benz  
 VW

**Part no.**  
 302403L

## Ball-joint remover

for pressing the ball joint cone out of the stub axle using the 10 t hydraulic cylinder.

E.g. for Mercedes-Benz W211, W221, W215, W219, W220, W230.



Mercedes-Benz

**Part no.**  
 302404L



## Supporting joint tool



for removing and installing the outer supporting joint without dismantling the steering knuckle  
Mercedes-Benz series E / S / SL (W220/W211/W230).

Mercedes-Benz

- 2 pressure pieces
- 47 mm inner diameter, 57 mm outer diameter
- 23 mm inner diameter, 33 mm outer diameter
- 2 pressure sleeves
- 39 mm inner diameter
- 53 mm inner diameter

with 185 mm spindle, 24 mm hexagon drive



**Description**  
Supporting joint tool

**Part no.**  
10009L

## Pressure pad set



as a supplement to the supporting joint tool 10009L.  
For stabiliser ball joint Mercedes-Benz (OE 211 323 00 68) W211, W220, W230.  
All work can be carried out directly at the vehicle without further parts having to be removed.

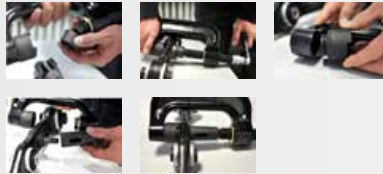

Mercedes-Benz

**Description**  
Supplementary set ball joint

**Part no.**  
10017L

## Supporting joint tool



for removing and installing the outer ball joints without dismantling the steering knuckle in Mercedes-Benz E / S / SL / M class (W220/W211/W230/W163/W164).

Mercedes-Benz

Incl. groove nut wrench for screwed supporting joints and pressure pieces for replacement of the stabiliser ball joints (OE no. 2113230068) in the wishbone of (W211/W220/W230).



① Including 10009L, 10017L und 10336L

**Part no.**  
302402L

## Grooved nut wrench



to install and remove the screwed ball joints on the front and rear axles.

Mercedes-Benz

- 12.5 mm (1/2") drive
- External diameter 63 mm
- External diameter 53 mm

Suitable for:  
Mercedes-Benz (M class) W163 / W164



**Description**  
Groove nut wrench for MB M-Class W163/W164

**Part no.**  
10336L



## Pressure pad set

DBGM

For upper and lower ball joints, front axle and rear axle, ø 45 mm

- Mercedes-Benz M-Class W163 '98 -'05, W164 '05 -'11



Mercedes-Benz

Only in combination with hydraulic cylinder and pressure bolt.

Description	Part no.
<b>Pressure pad set</b>	<b>301411L</b>
Housing	301423L

## Pressure pad set

for removing and installing the outer ball joint without steering knuckle dismantling

- W211 (E-Class from '02), W220 (S-Class from '99)
- W215, W219, W230



Mercedes-Benz

Only in combination with hydraulic cylinder and pressure bolt!

Description	Part no.
<b>Pressure pad set complete</b>	<b>301406L</b>
Housing	301288L

## Ball joint tool set

to replace the ball joints with a press frame.

- For Mercedes-Benz W124, W201



Mercedes-Benz

Description	Part no.
<b>Ball joint tool set</b>	<b>302409L</b>
Pressure piece from 302409L	302410L

## Pressure pad set

To replace the lower ball joint on the front axle wishbone, ø 46 mm.

Up to 2 hours time-saving, no need for additional axle adjustment!

- Mercedes-Benz 124, 129, 201



Mercedes-Benz

Supplement to pressure pad set 301286L

Description	Part no.
<b>Pressure pad set</b>	<b>301408L</b>

## Groove nut key

for removing and installing the screwed ball joints in Citroën BX, C5, Xantia Peugeot 305, 405, 406, 605, 607.



Peugeot  
Citroën

Part no.
<b>302405L</b>

## Ball joint tool set

to replace the ball joints with a press frame.

- For Renault Scenic II, Grand Scenic II, Megane II

① In combination with press frame!



Part no.  
302408L

## Pressure pad set

to replace the ball joint, front axle, Ø 38 mm

- Renault Laguna/Espace till '02, Safrane till '00, Avantime till '03, Espace III till '02

① In combination with press frame!



Part no.  
301449L

## Pressure pad set

for the removal and installation of the lower ball joint

Suitable for:

- Opel Movano
- Renault Master from '98
- Nissan Interstar from '02

① Only in connection with pressure pad set 301286L!

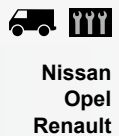
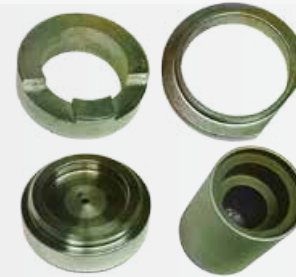

Part no.  
301325L

## Ball joint tool set

for replacing the ball joints on the Jeep Wrangler with adjustable pressing frame.



Part no.  
302400L

# Front Suspension Bushes

## Silent bearing/supporting joint tool set

for pressing in/out of supporting joints or silent bearings with 18.2 t hydraulic cylinder, pressing frame and pressure pieces in various sizes.  
44 pressure pieces with diameters from (A/I) 26 x 18 mm to 68 x 60 mm and lengths from 40 mm to 100 mm.

① Complete set with 18,2 t hydraulic spindle and pressure piece.



Part no.  
302100L



## Pressure piece set

20 pressure pieces with diameters from (A/I) 70 x 60 mm to 88 x 80 mm and lengths from 40 mm to 110 mm.



① Ideal complement for article 302100L / 302102L / 302103L

Part no.  
302101L

## Silent bearing/supporting joint tool set

with additional pressing frame and pressure pieces in various sizes. 44 pressure pieces, 40 and 100 mm long, with diameters from (A/I) 26 x 18 mm to 68 x 60 mm.



① Complete set with 10 t hydraulic spindle and pressure piece.

Part no.  
302102L

## Silent bearing/supporting joint tool set

with additional pressure pieces in various sizes. 44 pressure pieces, 40 and 100 mm long, with diameters from (A/I) 26 x 18 mm to 68 x 60 mm.



Part no.  
302103L

## Pressing clamp

For the removal and retraction of silent bearings, hydraulic bearings, bushings, ball bearings, rubber bearings, etc. to passenger cars and commercial vehicles.



① To be used with 10032L tension /thrust sleeve set and with 09681L hydraulic spindle 12 t!

Description  
220 mm clamping range

Part no.  
10032L-1

## Tension / thrust sleeve set

For the removal and retraction of silent bearings, hydraulic bearings, bushings, ball bearings, rubber bearings, etc. to passenger cars and commercial vehicles. Also to be used for rubber bushes and radial sealing rings

- slightly supported by industrial ball bearing on the spindle nut
- four spindles in 350 mm length, M10, M12, M14 and M16
- eight pressure nuts with bearing: M10, M12, M14, M16
- 20 pressure pieces, slit for visual inspection
- can also be used with a workshop press or press frame

### Dimensions of the sleeves:

Outer Ø Inner Ø [mm] Height inside - 50 mm

- 44/34 - 46/36 - 48/38 - 50/40 - 52/42 - 54/44 - 56/46 - 58/48 - 60/50 - 62/52
- 64/54 - 66/56 - 68/58 - 70/60 - 72/62 - 74/64 - 76/66 - 78/68 - 80/70 - 82/72

① Trapezoidal thread for high loads!



Description	Part no.
32-piece	10032L
Tr10 x 2.0 spindle	10032L-2
Tr12 x 2.0 spindle	10032L-3
Tr14 x 2.5 spindle	10032L-4
Tr16 x 3.0 spindle	10032L-5
M18 x 1.5 spindle	10032L-6

## Rubber bearing tool set

for pressing in/out of the rubber bearings in the front axle's wishbone for VAG.

Suitable for:

- Audi A3 from '03, TT from '06
- Škoda Octavia from '04, Superb from '08, Yeti from '09,
- Seat Altea from '04, Toledo from '04, Alhambra from '10, Leon from '05
- VW Golf from '03, Passat from '05, Tiguan from '07, Jetta from '05, Caddy from '04, Eos from '06, Scirocco from '08, Touran from '03, Sharan from '10.



Audi  
VW  
Škoda  
Seat

Part no.  
302416L

## Rubber bearing tool set

to replace the rubber bearings in the front axle wishbone.

Suitable for:

- Ford Galaxy
- Seat Alhambra
- VW Sharan



VW  
Seat  
Ford

Part no.  
302431L

## Rubber bearing tool set

to replace the rubber bearings in the wishbone (below/rear) of the front axle. Suitable for

Suitable for:

- Seat Leon, Toledo II
- Škoda Octavia
- VW Bora, Golf IV



VW  
Seat  
Škoda

Artikel  
302433L





## Rubber bearing tool set

For removal and installation of the plastic / aluminum bearing on the axle support bracket (bracket does not have to be removed).

Suitable for:

- Audi A2 '00 - '05
- VW Polo 9N from '01, Fox from '05
- Škoda Fabia from '00, Roomster from '06
- Seat Cordoba, Ibiza from '02

Also for bearing block (removal required) on:

- Audi A3 from '03
- VW Caddy III, Eos from '06, Golf V from '03, Jetta III from '05, Passat from '05, Touran from '03, Tiguan from '07
- Seat Altea from '04, Leon from '05, Toledo from '04
- Škoda Octavia from '04.



Audi  
VW  
Škoda  
Seat

Part no.  
**302413L**

## Rubber bearing tool set

For removal and installation of the plastic / aluminum bearing on the axle support bracket (bracket does not have to be removed).

Suitable for:

- Audi A2 '00 - '05
- VW Polo 9N from '01, Fox from '05
- Škoda Fabia from '00, Roomster from '06
- Seat Cordoba, Ibiza from '02

Also for bearing block (removal required) on:

- Audi A3 from '03
- VW Caddy III, Eos from '06, Golf V from '03, Jetta III from '05, Passat from '05, Touran from '03, Tiguan from '07
- Seat Altea from '04, Leon from '05, Toledo from '04
- Škoda Octavia from '04.



Seat  
Audi  
VW  
Škoda



### Description

- Rubber bearing tool
- Pressure Pad (removal)
- Pressure Pad (installation)

Part no.  
**301289L**  
**301291L**  
**301295L**

## Rubber bearing tool set

for engine bracket on the front axle (71 mm diameter)

- Audi A4 '94-'08, A6 '97-'04
- VW Passat '96-'05
- Škoda Superb from '02



Škoda  
VW  
Audi

### Description

Complete tool

Part no.  
**301313L**

## Rubber bearing tool set

for exchanging the silent bearing (double bearing) in the engine cradle.

Suitable for:

- Audi A3 (8P1) from '03, TT (8J3, 8J9) from '06 - '10,
- Seat Altea (5P5, 5P8) from '04, Leon (1P1) from '05, Toledo III (5P2) from '04 - '09,
- Škoda Octavia (1Z3, 1Z5) from '04 - '10,
- VW Caddy III (2KA, 2KB, 2KH, 2KJ, 2CA, 2CB, 2CH, 2CJ) from '04 - '10, EOS (1F7, 1F8) from '06 / Golf Plus, V, VI (5M1, 521, 1K1, 1K5, 5K1, AJ5) from '03 - '09, Jetta III (1K2) from '05 - '10, Touran (1T1, 1T2, 1T3) from '03, Passat (3C2, 3C5, 362, 365) from '05 - '10, Scirocco (137) from '08, Tiguan (5N) from '07.

ⓘ Only for engine brackets made of aluminium

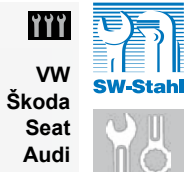

Description

12-piece

Part no.

302501L

## Rubber bearing tool set

for exchanging the silent bearing (double bearing) in the engine cradle.

Suitable:

- Audi A3 (8P1) from '03, TT (8J3, 8J9) from '06 - '10
- Seat Altea (5P5, 5P8) from '04, Leon (1P1) from '05, Toledo III (5P2) from '04 - '09
- Škoda Octavia (1Z3, 1Z5) from '04 - '10
- VW Caddy III (2K, 2KB, 2KH, 2KJ, 2CA, 2CB, 2CH, 2CJ) from '04 - '10, EOS (1F7, 1F8) from '06, GolfPlus, V, VI (5M1, 521, 1K1, 1C5, 5K1, AJ5) from '03 - '09, Jetta III (1K2) from '05 - '10, Touran (1T1, 1T2, 1T3) from '03, Passat (3C2, 3C5, 362, 365) from '05 - '10, Scirocco (137) from '08, Tiguan (5N) from '07

ⓘ Only for engine brackets made of aluminium



Description

13-piece

Part no.

302500L

## Rubber bearing tool set

to replace the rubber bearing in the wishbone, Ø 36,5/37 mm.

Suitable for:

- Audi A3 from '03, TT from '06
- Mercedes-Benz Vito W638/639 from '96, Viano W639 from '03, V-Class W638/2 '96 - '03
- Škoda Octavia from '04, Superb from '08, Yeti from '09, Altea from '04, Toledo from '04, Leon from '05
- Seat Alhambra from '10
- VW Golf from '03, Passat from '05, Tiguan from '07, Jetta from '05, Caddy from '04, Eos from '06, Scirocco from '08, Touran from '03, Sharan from '10

ⓘ In combination with 301201L, mechanical.  
Please always use the pressure ring 301201L in additional for VAG vehicles

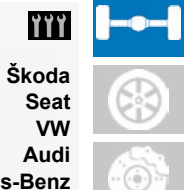
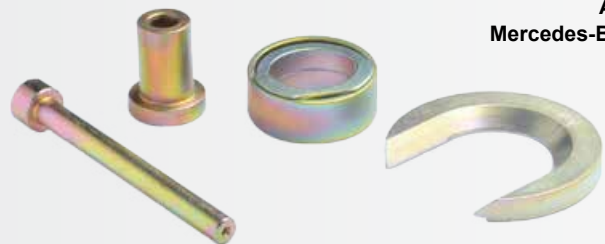

Part no.

301428L

## Pressure ring

ⓘ Required mandatory at VAG vehicles



Description

Pressure ring for VAG vehicles

Part no.

301300L



## Rubber bearing tool set

for wishbone front axle, Ø 60/31 mm



VW  
Audi  
Seat  
Škoda

Suitable for:

- Audi A1 from '10, A3 '96-03, TT '98-06
- Seat Cordoba '93-03, Ibiza from '93, Inca '95-03, Leon '99-06, Mii from '11, Toledo from '91
- Škoda Citigo from '11, Fabia from '06, Octavia '97-10, Rapid from '12, Roomster from '06
- VW Golf '84-05, Golf Variant '83-06, Bora '98-05, Caddy '95-04, Corrado '87-95, Jetta '84-92, New Beetle from '98, Passat '88-97, Polo from '94, Polo Classic '95-02, Polo Variant '97-01, UP from '11, Vento '91-98



① In combination with 301201L, mechanical

Part no.  
301237L

## Rubber bearing tool set

to replace the rubber bearing in the lower wishbone, Ø 35/45 mm.



VW  
Seat  
Ford

Suitable for:

- VW T4 '90-'03, (Ø 45 mm)
- VW T4 '90-'03 (Ø 35 mm)
- VW Sharan '95
- Ford Galaxy '95
- Seat Alhambra '96 (front and rear suspension)



① In combination with 301201L, mechanical

Description	Part no.
Pressure pad set complete	301257L

## Rubber bearing tool set

for exchanging the rubber bearings in the front axle's wishbone for: Mercedes-Benz W210 from '96 - '01.



Mercedes-Benz



Part no.  
302418L

## Rubber bearing tool set

for exchanging the rubber bearings in the front axle's wishbone.



Mercedes-Benz

Suitable for: Mercedes-Benz W170, W202.



Part no.  
302419L

## Rubber bearing tool set

for exchanging the rubber bearings in the front axle's wishbone.



Mercedes-Benz

Suitable for: Mercedes-Benz W203, W211, W220.



Part no.  
302421L



## Assembly/disassembly set Mercedes-Benz, universal

To replace the rubber bearings in the front axle wishbones.

Suitable for:

- Mercedes-Benz W203/W204/W209/W211/W220/W221.



Mercedes-Benz



Part no.  
302104L

## Rubber bearing tool set

for replacing the rubber bearings of the front and rear axles' wishbone and longitudinal arms.

Suitable for:

- Mercedes-Benz, W203, W204, W209, W211, W220.



Mercedes-Benz



Part no.  
302351L

## Rubber bearing tool set

for lower wishbones, Ø 70/71 mm

Suitable for:

- Mercedes-Benz C-Class 203 '00-'06, CLK 209 from '02, SLK 171 from '04, CLS 219 from '04, E-Class 211 from '02
- Opel Corsa D from '06, Adam from '12
- Alfa Romeo Mito from '08
- Citroën Nemo from '08
- Fiat Fiorino from '08, Linea from '07, Punto Evo '09-'12, Punto from '12, Grande Punto from '05
- Peugeot Bipper from '08



Peugeot  
Opel  
Fiat  
Citroën  
Alfa Romeo  
Mercedes-Benz



ⓘ In combination with 301201L, mechanical

Part no.  
301413L

## Rubber bearing tool set

for wishbones, Ø 38 mm.

- Mercedes-Benz Sprinter from '95-'06
- VW LT from '97-'06



Mercedes-Benz  
VW



ⓘ In combination with 301201L, mechanical

Part no.  
301419L



## Rubber bearing tool set



to replace the rear rubber bearing in the front wishbone, Ø 60 mm.

Mercedes-Benz

Suitable for:

- Mercedes-Benz A-Class W168 '97 - '04, W169 '04 - '12

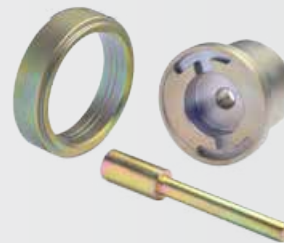

① In combination with 301201L, mechanical

Description	Part no.
Pressure pad set complete	301429L
Centering bolt 12 mm lang	301232L

## Rubber bearing tool set



to replace the front rubber bearing in the front wishbone, Ø 40 mm.

Mercedes-Benz

Suitable for:

- Mercedes-Benz A-Class W168 '97 - '04, W169 '04 - '12



① In combination with 301201L, mechanical

Part no.  
301430L

## Assembly tool



for removing and installing the wishbone from the hydraulic bearing in mounted condition on the front axles of Mini One, Cooper, Cooper S (R50, R52, R53).

Mini

Can be used like: BMW OE no. 315140.



① Ideal in combination with 302415L!

Part no.  
302414L

## Rubber bearing tool set



for replacing the hydraulic bearing on the wishbone in mounted condition on the front axles of Mini One, Cooper, Cooper S (R50, R52, R53, R55, R56).

Mini

Can be used as: BMW OE No. 315150



① Ideal in combination with 302414L!

Part no.  
302415L

## Rubber bearing tool set

all-in-one tool for replacing the rubber and hydraulic bearings on the wishbone, braces and struts of the front axle with hydraulic cylinder.

Suitable for: BMW 1 series, 3 series, 5 series, 7 series, X5 (E31 / E32 / E34 / E38 / E39 / E53 / E60 / E65 / E66 / E70 / E82 / E87 / E88 / E90 / E91 / E92 / E93 / F01 / F02 / F03).



BMW



Part no.  
302422L

## Rubber bearing tool set

for replacing the slotted rubber bearings in the rear axle leg.

Suitable for: BMW 1 series E87, 3 series E90 E91 E92 E93.



BMW



Part no.  
302417L

## Rubber bearing tool set

to replace the rubber bearings on the **struts** of the front axle when installed.

Suitable for:

- BMW 5 series E39
- BMW M5 E39

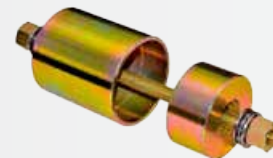

BMW



Part no.  
302424L

## Rubber bearing tool set

to replace the hydrobearings on the **tie bars** of the front axle.

Suitable for:

- BMW 5 series E39



BMW



Part no.  
302425L

## Rubber bearing tool set

to replace the rubber bearings in the front axle wishbone.

Suitable for:

- Opel Astra G und H, Combo, Meriva



Opel



Part no.  
302332L



## Rubber bearing tool set

to replace the rear rubber bearings in the wishbone of the front axle.

Suitable for:

- Opel Astra G, H, Zafira, Vectra B



Opel

Part no.

302432L

## Rubber bearing tool set

to replace the front rubber bearing, Ø 39 mm.

Suitable for:

- Opel Corsa D from '06, Adam from '12
- Alfa Romeo Mito from '08
- Citroën Nemo from '08
- Fiat Fiorino from '08, Linea from '07, Punto Evo '09 - '12, Punto from '12, Grande Punto from '05
- Peugeot Bipper from '08



Opel  
Alfa Romeo  
Citroën  
Fiat  
Peugeot



① In combination with 301201L, mechanical

Part no.

301331L

## Rubber bearing tool set

to replace the rubber bearings in the lower wishbone of the front axle.

Suitable for:

- Renault Laguna I und II, Traffic II, Espace IV
- Opel Vivaro

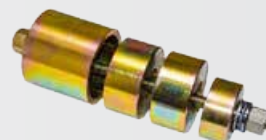

Opel  
Renault

Part no.

302426L

## Rubber bearing tool set

to replace the rubber bearings in the wishbone behind the front axle.

Suitable for:

- Renault Laguna I



Renault

Part no.

302429L

## Rubber bearing tool set

to replace the rubber bearings in the front axle wishbone.

Suitable for:

- Renault Laguna I and II, Trafic II, Espace IV



Renault

Part no.

302428L

## Rubber bearing tool set

to replace the rubber bearings in the front axle wishbone.

Suitable for:

- Renault Clio II, Kangoo I, Thalia I



Part no.  
302427L

## Rubber bearing tool set

to replace the front rubber bearing, Ø 33 mm.

Suitable for:

- Renault Mégane II from '02, Scénic II from '03



① In combination with 301201L, mechanical

Description  
Pressure pad set complete

Part no.  
301462L

## Rubber bearing tool set

to replace the rubber bearings in the front axle wishbone.

Suitable for:

- Fiat Punto Grande (199), Fiorino, Qubo, Linea

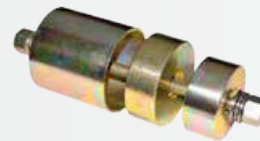

Part no.  
302434L

## Rubber bearing tool set

to replace the front rubber bearing, Ø 31 mm.

Suitable for:

- Toyota Yaris '99 - '06, Yaris Verso from '99



① In combination with 301201L, mechanical

Part no.  
301445L

## Rubber bearing tool set

to replace the rear front rubber bearing, Ø 55 mm.

Suitable for:

- Toyota Yaris '99 - '06, Yaris Verso from '99

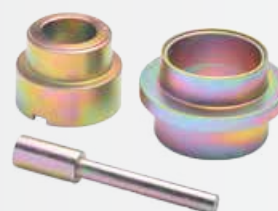

① In combination with 301201L, mechanical

Part no.  
301444L





## Silent bearing/supporting joint tool set



for pressing in/out of supporting joints or silent bearings with 18.2 t hydraulic cylinder, pressing frame and pressure pieces in various sizes. 44 pressure pieces with diameters from (A/I) 26 x 18 mm to 68 x 60 mm and lengths from 40 mm to 100 mm.



① Complete set with 18,2 t hydraulic spindle and pressure piece.

Part no.  
302100L

## Pressure piece set

20 pressure pieces with diameters from (A/I) 70 x 60 mm to 88 x 80 mm and lengths from 40 mm to 110 mm.



① Ideal complement for article 302100L / 302102L / 302103L

Part no.  
302101L

## Silent bearing/supporting joint tool set



with additional pressing frame and pressure pieces in various sizes. 44 pressure pieces, 40 and 100 mm long, with diameters from (A/I) 26 x 18 mm to 68 x 60 mm.



① Complete set with 10 t hydraulic spindle and pressure piece.

Part no.  
302102L

## Silent bearing/supporting joint tool set



with additional pressure pieces in various sizes. 44 pressure pieces, 40 and 100 mm long, with diameters from (A/I) 26 x 18 mm to 68 x 60 mm.



Part no.  
302103L

## Pressing clamp



For the removal and retraction of silent bearings, hydraulic bearings, bushings, ball bearings, rubber bearings, etc. to passenger cars and commercial vehicles.

① To be used with 10032L tension / thrust sleeve set and with 09681L hydraulic spindle 12 t!



Description  
220 mm clamping range

Part no.  
10032L-1

## Tension / thrust sleeve set

For the removal and retraction of silent bearings, hydraulic bearings, bushings, ball bearings, rubber bearings, etc. to passenger cars and commercial vehicles. Also to be used for rubber bushes and radial sealing rings

- slightly supported by industrial ball bearing on the spindle nut
- four spindles in 350 mm length, M10, M12, M14 and M16
- eight pressure nuts with bearing: M10, M12, M14 and M16
- 20 pressure pieces, slit for visual inspection
- can also be used with a workshop press or press frame

Dimensions of the sleeves:

Outer Ø Inner Ø [mm] Height inside - 50 mm

- 44/34 - 46/36 - 48/38 - 50/40 - 52/42 - 54/44 - 56/46 - 58/48 - 60/50 - 62/52
- 64/54 - 66/56 - 68/58 - 70/60 - 72/62 - 74/64 - 76/66 - 78/68 - 80/70 - 82/72

① Trapezoidal thread for high loads!



Description	Part no.
32-piece	<b>10032L</b>
Tr10 x 2.0 spindle	<b>10032L-2</b>
Tr12 x 2.0 spindle	<b>10032L-3</b>
Tr14 x 2.5 spindle	<b>10032L-4</b>
Tr16 x 3.0 spindle	<b>10032L-5</b>
M18 x 1.5 spindle	<b>10032L-6</b>

## Rubber bearing tool set

to replace rubber bearing in trailing arm, Ø 60 mm.

- Audi A3 from '03, A1 from '12, Q3 from '11, TT from '06
- Seat Altea from '04, Toledo III '04-'09, Leon from '05
- Škoda Octavia from '04, Superb from '08, Yeti from '09
- VW Golf V and VI, Golf V / VI Variant from '07, Golf Plus from '05, Touran from '03, Passat from '05, Passat Variant from '05, Jetta III from '05, Beetle from '11, Eos from '06, Scirocco from '08, Tiguan from '07

① In combination with 301201L, mechanical



Part no.  
**301298L**

## Rubber bearing tool set

for removing and installing silent bearings (rear axle)

Suitable for:

- VW Golf II & Jetta model year '84 - '92

① In combination with 301201L, mechanical



Part no.  
**301229L**



Seat  
Škoda  
VW  
Audi



VW





## Rubber bearing tool set



for removing and installation silent bearings (rear axle) on the vehicle.  
Exact changing through correct centering

VW

- VW Passat '88 - '97, Golf III Estate from '92

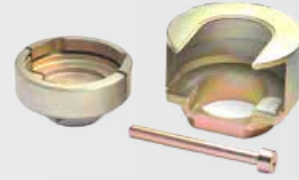

ⓘ Only with hydraulic

Part no.  
301240L

## Rubber bearing tool set



to replace the hydro-bearing in rear axle, Ø 56 mm.

Audi

Suitable for:

- Audi A4 Quattro '00-'08, A6 Quattro from '04

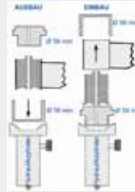

ⓘ In combination with 301201L, mechanical

Part no.  
301309L

## Rubber bearing tool set



to replace the rubber bearing in rear axle, Ø 56 mm.

Audi

Suitable for:

- Audi 80 '91-'94, A4 '94-'00



Description	Part no.
Complete tool	301249L
Pressure piece No. 11	301250L

Part no.  
301249L  
301250L

## Rubber bearing tool set



to replace the rubber on the rear axle wishbone.

VW

Suitable for:

- VW T5



Part no.  
302330L

## Rubber bearing tool set



for replacing the rubber bearings of the front and rear axles' wishbone and longitudinal arms.

Mercedes-Benz

Suitable for:

- Mercedes-Benz, W203, W204, W209, W211, W220



Part no.  
302351L



## Hydraulic bearing tool

for exchanging the hydraulic bearings on the rear axle shaft with a diameter of 40 mm directly on the vehicle.

Suitable for:

Mercedes-Benz E-class 124 '84 - '95, SL 129 '89 - '01, S-class 140 '91 - '99, SLK 170 '96 - '04, SLK 171 '04 - '11, SLK 172 from '11, 190-series 201 '82 - '93, C-class 202 '93 - '01, C-class 203 '00 - '07, C-class 204 from '07, GLK-class 204 from '08, CLK 208 '97 - '02, CLK 209 '02 - '10, E-class 207 from '09, E-class 210 '95 - '02, E-class 211 '02 - '08, E-class 212 from '09, S-class 215 '99 - '06, S-class 216 from '06, CLS 219 '04 - '10, S-class 220 '99 - '05, S-class 221 from '05



Mercedes-Benz



Part no.

302302L

## Rubber bearing tool set

for exchanging the rubber bearings on the rear axle subframe, for mounting to the car body.

Suitable for: Mercedes-Benz W124, W201.



Mercedes-Benz

Part no.

302311L

## Rubber bearing tool set

for exchanging the rubber bearings on the rear axle subframe, for mounting to the car body.

Suitable for: Mercedes-Benz (S class) W140 '92 - '00, W220 from '00.



Mercedes-Benz

Part no.

302312L

## Rubber bearing tool set

for exchanging the rubber bearings on the rear axle subframe, for mounting to the car body.

Suitable for: Mercedes-Benz W 203, W209, R171.



Mercedes-Benz

Part no.

302313L

## Rubber bearing tool set

for exchanging the rubber bearings on the rear axle subframe, for mounting to the car body.

Suitable for: Mercedes-Benz W 204



Mercedes-Benz

Part no.

302352L



## Rubber bearing tool set

for exchanging the rubber bearings on the rear axle subframe, for mounting to the car body.

Suitable for: Mercedes-Benz W210.



Mercedes-Benz

Part no.  
302316L

## Rubber bearing tool set

for exchanging the rubber bearings on the rear axle subframe, for mounting to the car body.

Suitable for:  
▪ Mercedes-Benz (S class/CL class) W/V220, C215

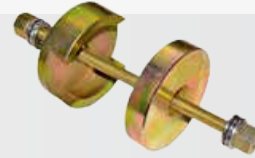

Mercedes-Benz

Part no.  
302346L

## Rubber bearing tool set

for exchanging the rubber bearings on the rear axle subframe, for mounting the differential (rear bearings).

Suitable for: Mercedes-Benz W140, W202, W203, W210.



Mercedes-Benz

Part no.  
302315L

## Rubber bearing tool set

for exchanging the rubber bearings on the rear axle subframe, for mounting the differential (front bearings).

Suitable for: Mercedes-Benz W140, W202, W203, W210.



Mercedes-Benz

Part no.  
302314L

## Rubber bearing tool set

for replacing the slotted rubber bearings in the rear axle leg.

Suitable for: BMW 1 series E87, BMW 3 series E90 E91 E92 E93.



BMW

Part no.  
302307L

## Rubber bearing tool set

to replace the split rubber bearings in the rear axle swing arm.

Suitable for:  
▪ BMW 5 series E60, E61 / 7 series E65

Huge savings, as it is no longer necessary to replace the swing arm!



BMW

Part no.  
302324L

## Rubber bearing tool set

for exchanging the rubber bearings on the rear axle subframe, for mounting to the car body.

Suitable for: BMW 3 series E46, Z4 E85.



BMW

Part no.  
302321L

## Rubber bearing tool set

for exchanging the rubber bearings on the rear axle subframe, for mounting to the car body.

Suitable for: BMW 1 series E81, E82, E87, E88 / 3 series E90, E91, E92, E93.



BMW

Part no.  
302308L

## Rubber bearing tool set

for exchanging the rubber bearings on the rear axle subframe, for mounting the differential (front bearings).

Suitable for: BMW 3 series E46, Z4 E85.



BMW

Part no.  
302319L

## Rubber bearing tool set

for exchanging the rubber bearings in the rear axle member, for mounting the differential (rear bearings).

Suitable for: BMW 3 series E46, Z4 E86.



BMW

Part no.  
302320L

## Rubber bearing tool set

for exchanging all rubber/metal bearings in the rear axle's longitudinal link (older bearing version).

Suitable for: BMW 3 series E36, E46 / Z4 E85.



BMW

Part no.  
302317L

## Rubber bearing tool set

for replacing the rubber/ metal bearings in the linkage of the rear axle (old and new bearings).

Suitable for: BMW 3 E36, E46 / Z4 E85



BMW

Part no.  
302318L





## Rubber bearing tool set

for replacing the front slotted rubber bearings in the rear axle swingarm's longitudinal link.

Suitable for: BMW 3 series E46.



BMW

Part no.  
302350L

## Rubber bearing tool set

to replace the front rubber bearings in the rear axle swing arm.

Suitable for: BMW 3 series E36, E46

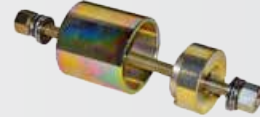

BMW

Part no.  
302339L

## Rubber bearing tool set

for exchanging the rubber bearings with 78 mm diameter on the rear axle subframe (centre) without removing the subframe.

Suitable for: BMW 5-series (E39), BMW 7-series (E38)



BMW

Part no.  
302304L

## Pressure pad set

for rear axle swingarm longitudinal link, Ø 60 mm

- BMW 3 series E36 '90-'98, Cabrio '93-'99, Coupe '92-'99, Touring '95-'99, E46 '98-'05, Cabrio from '00, Compact '01-'05, Coupé from '99, Touring '99-'05, E83 from '04

① In combination with 301201L, mechanical

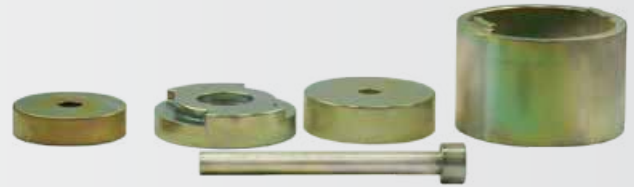

BMW

Part no.  
301494L

## Rubber bearing tool set

for exchanging the rubber bearings with 95 mm diameter on the rear axle subframe (centre) without removing the subframe.

Suitable for: BMW X5 (E53)



BMW

Part no.  
302305L

## Pressure pad set

for exchanging the rubber bearings with 78 mm diameter on the rear axle subframe (centre) without removing the subframe.

Suitable for: BMW E38 - E39

ⓘ Only in combination with hydraulic cylinder!



BMW

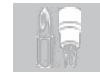

Description

8-piece

Tension nut complete M12 x 50

Part no.

301487L

301489L

## Rubber bearing tool set

for exchanging the rubber bearings in the rear axle subframe, for mounting the differential (front and rear bearings).

Suitable for: BMW 5 series E39, 7 series E38.



BMW

Part no.

302322L

## Rubber bearing tool set

for exchanging the rubber bearings in the rear axle subframe, for mounting the differential (front bearings).

Suitable for: BMW 5 series E39, BMW 7 series E38

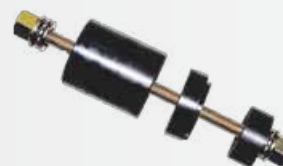

BMW

Part no.

302340L

## Rubber bearing tool set

for exchanging the rubber bearings in the rear axle subframe, for mounting the differential (rear bearings).

Suitable for: BMW 5 series E39, 7 series E38



BMW

Part no.

302341L

## Rubber bearing tool set

for exchanging the rubber bearings in the rear axle subframe, for mounting the differential (rear bearings).

Suitable for: BMW X5 E53.



BMW

Part no.

302309L



## Rubber bearing tool set

for exchanging the rubber bearings in the rear axle subframe, for mounting the differential (front bearings).

Suitable for: BMW X5 E53.



BMW



Part no.  
302310L

## Rubber bearing tool set

for exchanging the rubber bearings in the rear axle subframe, for mounting the differential (front bearings).

Suitable for: BMW X5 E53



BMW

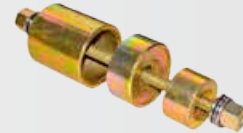

Part no.  
302342L

## Rubber bearing tool set

for exchanging the rubber bearings in the rear axle subframe, for mounting the differential (rear bearings).

Suitable for: BMW X5 E53



BMW

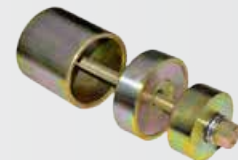

Part no.  
302343L

## Rubber bearing tool set

to replace the rubber bearings in the upper steering knuckle of the rear axle.

Suitable for: Opel Vectra C



Opel



Part no.  
302333L

## Rubber bearing tool set

to replace the hydrobearings in the rear axle.

Suitable for:

- Opel Vectra B
- BMW 3 series E36



Opel  
BMW



Part no.  
302331L

## Pressure pad set

Rear axle 63-65/65-67 mm

e.g. Opel Vectra B '95-'03

① In combination with nut (301078L), mechanical



Part no.  
301316L



Opel



## Rubber bearing tool set

to replace the rubber bearings in the rear axle.

Suitable for: Opel Astra H '04 - '09, Zafira B '05 - '11, Meriva B from '10



Part no.  
302327L



Opel



## Rubber bearing tool set

To replace the rubber bearing on the vehicle without a complete exchange of the swingarm, rear linkage 60 mm diameter suitable for:

- Ford Focus from '98 - '04, Focus II from '04, C-Max '03 - '07, Kuga from '08
- Mazda 3 from '03, 5 from '05
- Volvo C 30 from '06, S 40 II from '04, V 50 from '04



Part no.  
302300L



Volvo  
Mazda  
Ford



## Rubber bearing tool set

to replace the rubber bearings in the trailing arm of the rear axle without complete replacement of the swing arm.

Suitable for:

- Ford Focus from '98 - '04, Focus II from '04, C-Max from '03 - '07, Kuga from '08,
- Mazda 3 from '03, 5 from '05
- Volvo C30 from '06, S40 II from '04, V50 from '04



Part no.  
302344L



Ford  
Volvo  
Mazda



## Rubber bearing tool set

to replace the rubber bearings in the rear axle wishbone.

Suitable for: Ford Mondeo



Part no.  
302345L



Ford





## Pressure pad set

for the removal and installation of rubber bearings on the vehicle without complete replacement of the longitudinal link at the rear, 60 mm diameter. Suitable for:

- Ford Focus from '98-'04
- Ford Focus II from '04
- Ford C-Max '03 - '07
- Ford Kuga from '08
- Mazda 3 from '03
- Mazda 5 from '05
- Volvo C 30 from '06
- Volvo S 40 II from '04
- Volvo V 50 from '04

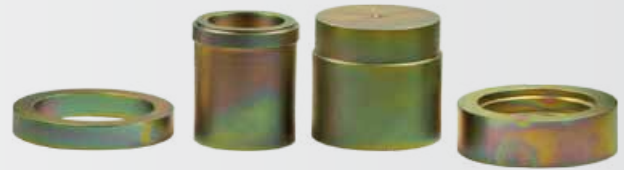

Ford  
Mazda  
Volvo

ⓘ In combination with 301201L, mechanical

Part no.  
301333L

## Rubber bearing tool set

to replace the rubber bearings in the rear axle wishbone.

Suitable for:

- Ford Focus II, C-Max
- Mazda 3 and 5
- Volvo S40II



Volvo  
Mazda  
Ford

Part no.  
302337L

## Rubber bearing tool set

For replacing the rubber bearing on the vehicle without a complete exchange of the swingarm, rear axle 90 mm diameter.

- Ford Mondeo from '07
- Mondeo Turnier '00-'07, S-Max from '06,
- Galaxy from '06
- Volvo XC 70 from '07, V70 from '07, XC 60 from '08, S60 from '10, S80 from '06, V60 from '10



Part no.  
302301L

## Rubber bearing tool set

to replace the rubber bearing in the trailing arm of the rear axle.

Suitable for:

- Ford Fiesta and Ka



Ford

Part no.  
302334L

## Pressure pad set

to replace the ball joint at the rear axle, Ø 60 mm

Suitable for:

- Toyota Aygo from '05
- Peugeot 107 from '05
- Citroën C1 from '05



Toyota  
Citroën  
Peugeot

ⓘ In combination with 301201L, mechanical

Part no.  
301448L







## Assembly set

to install the hydrobearings in the rear axle.

Suitable for:

- Fiat Stilo, Multipla, Albea

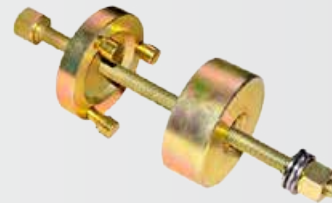

Fiat

Part no.  
302328L

## Rubber bearing tool set

to replace the rubber bearings in the rear axle.

Suitable for:

- Fiat Punto II



Fiat

Part no.  
302329L

## Rubber bearing tool set

to replace the rubber bearings in the rear subframe.

Suitable for:

- Fiat 500 from '07
- Panda from '03



Fiat

Part no.  
302348L

## Rubber bearing tool set

to replace the rubber bearings in the rear axle.

Suitable for:

- Fiat Punto, Barchetta, Lancia Y

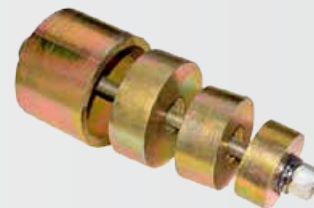

Fiat

Part no.  
302349L

## Rubber bearing tool set

for exchanging the rubber bearing on the rear axle's longitudinal link.

Suitable for:

- Subaru Impreza



Subaru

Part no.  
302323L

## Workshop press



Suitable for heavy-duty day-to-day work in the workshop

- Makes the replacement of e.g. wheel bearings, gear-shaft bearings, rubber bushes etc. much easier
- Large working range thanks to 9-fold adjustment of support surface
- Compression force can be read off on a large dial from 0 to 20 tons
- working range: 0 - 910 mm
- 20 tons



**Stroke**

150 mm

**Part no.**

20320L

## Set of fitting washers



suitable for fitting bearing shells, sealing rings and rubber seals. Particularly helpful when used with hydraulic presses.

Contains thrust washers in sizes 18 - 65 mm (in 1 mm increments) and 74 mm, as well as a 220 mm x Ø 12 mm metal grab handle for assembly using hammers.

All washers from size 34 mm have an inner diameter of 21 mm.



**Description**

52-piece

**Part no.**

10341L

## Set of fitting washers



suitable for fitting bearing shells, sealing rings and rubber seals. Particularly helpful when used with hydraulic presses.

Contains thrust washers in sizes 70 - 150 mm (in 5 mm increments), as well as a 273 mm x Ø 12 mm metal grab handle for assembly using hammers.



**Description**

21-piece

**Part no.**

10339L

## Bearing and sealing ring set



for flush and centred insertion of bearing rings and taper roller bearings.

The set contains one striking mandrel and thrust washers with 40 - 44 - 50 - 59 - 63 - 65 - 72 - 76 - 81 mm outer diameter. Made of full aluminium CNC lathed with maximum fitting accuracy



**Audi  
Ford  
Mercedes-Benz  
Seat  
VW**

① **Ideal for wheel bearing changing**

**Description**

10-piece

**Part no.**

10140L



## Wheel bearing tool set

for the fast removal and fitting of wheel bearings and hub without having to remove the suspension strut, which means no subsequent axle alignment is necessary



**YYY**

Audi  
Austin  
BMW  
Citroën  
Fiat  
Ford  
Honda  
Mazda  
Mercedes-Benz  
Mitsubishi  
Nissan  
Opel  
Peugeot  
Renault  
Toyota  
VW

Description	Part no.
25-piece	301030L
Ball bearing, encapsulated	301031L
Replacement spindle M22 x 1.8	301032L
Threaded bolt M12 x 1,50	301015L
Threaded bolt M14 x 1,50	301013L

## Wheel bearing tool

for removing and installing wheel bearings on the vehicle.

Suitable for Mercedes-Benz, BMW, Toyota, Ford, Volvo, etc.

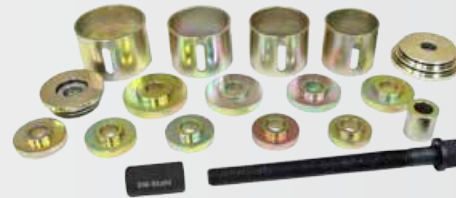

**YYY**

Toyota  
Mercedes-Benz  
Ford  
BMW  
Volvo

Part no.  
302207L

## Wheel bearing pressure piece set

Wheel bearing pressure piece set to install and remove hubs and wheel bearings.

Suitable for:

- Alfa Romeo
- Fiat
- Lancia
- Citroën
- Peugeot
- Renault
- Ford
- Audi
- VW



**YYY**

Ford  
VW  
Renault  
Peugeot  
Lancia  
Citroën  
Audi  
Alfa Romeo  
Fiat

Part no.  
302222L

## Spezial-Socket Set

for groove nuts

- for the gentle loosening of groove nuts
- Tighten with torque
- for use with e.g. bearing screw connections
- 12.5 mm (1/2") drive, length 60 mm
- Sizes: all dimensions in mm



**12.5 1/2 YYY**

ⓘ Further details can be found in the manual

Description	Part no.
11-piece, 22-75 mm	10334L
10-piece, 26-88 mm	10335L

## SAUER Internal Bearing Ring Removal Set, $\varnothing$ 40–61 mm



Ideal for removing bearing rings that lie flat, which often remain on the hub when removing wheel bearings.

Universal; for all vehicle types and internal bearing rings with an internal diameter of 35–55 mm.

- Jaw width: 40–61 mm



Description	Part no.
Remover set	81231300
$\varnothing$ 58,9 mm ring spanner	81231301
$\varnothing$ 82,7 mm ring spanner	81231302
Pressure spindle with cone, M20 x 1,5	81231303
Remover housing	81231304
Remover socket $\varnothing$ 40 - 45 mm	81231305
Remover socket $\varnothing$ 45 - 51 mm	81231306
Remover socket $\varnothing$ 50 - 55 mm	81231307
Remover socket $\varnothing$ 55 - 61 mm	81231308

## Circlip pliers



according to DIN, forged, chrome-plated

- sturdy shape
- non-slip precision tips
- Titan finish
- insulated handles
- for circlips 19 - 60 mm



① 1,7 mm tip  $\varnothing$

Description	Head version	Length	Part no.
For outer ring	Straight	180 mm	41301L
For outer ring	Bent	170 mm	41302L
For inner ring	Straight	180 mm	41401L
For inner ring	Bent	170 mm	41402L

## Circlip pliers



for wheel bearing circlips according to DIN 472 and 984, max tip diameter according to DIN 5256: 2.3 mm, for bore diameters of 40 - 100 mm, anti-slip handle.

The 45° angle of the tips enables precise work. Two available sizes cover all standard ranges of circlips used on wheel bearings.



Description	Length	Part no.
Size 2 / D 40-100 mm	220 mm	41310L
Size. 3 / D 85 - 140 mm	330 mm	41315L



## IMPACT screwdriver bits, Spline



1/2" drive, XZN tripe square M14, M16, M18 each in 40 + 75 mm length.

For installation of the high-strength screws to brake carrier and shock absorber fitting, brake system, drive wheel on the camshaft and rear brake callipers, work on the chassis as well as removal and installation of the wheel bearings/wheel hub unit on the Passat 3C, Touareg and Phaeton, Touran from 2004 and Audi A3 from 2004, Golf V and identical Škoda vehicles



Audi  
Škoda  
VW

Description	Size	Length	Profile	Part no.
6-piece			○	10195L
	M14	40 mm	○	10195L-14K
	M16	40 mm	○	10195L-16K
	M18	40 mm	○	10195L-18K
	M14	75 mm	○	10195L-14L
	M16	75 mm	○	10195L-16L
	M18	75 mm	○	10195L-18L

## IMPACT screwdriver bit, Spline



For the mounting of the retaining screw of wheel hub / wheel bearing units on the rear axle of Audi A3, Golf V, Touran as well as similar Škoda.

The complete unit is attached to the axle journal and assembled with the multi-point screw.



Audi  
Škoda  
VW

Profile	Length	Part no.
○	80 mm	301025L

## Supplementary set

- Audi A3, A4, A6, A8
- VW Golf IV, Passat from '97



VW  
Audi  
Škoda

① For use with mechanical set 301149L

Description	Part no.
Supplementary set completely	301155L
Pressure screw	301110L
Pressure piece	301092L
Pressure piece 72/40	301096L
Pressure piece 82/45	301097L
Pressure piece E-45	301105L
Pressure sleeve E44-1	301087L
Pressure sleeve E56-1	301185L

## Compact bearings tool set

for the damage-free fitting and removal of bearings/hub units with a diameter of 72 mm for

- VW: Polo 9N, Polo Stufenheck 9N, Polo 6R, Fox 5Z
- Seat: Ibiza 6L, Ibiza 6J, Ibiza Sportcoupé 6J, Ibiza ST 6J, Toledo KG, Cordoba 6L
- Audi: A1 8X, A1 Sportback 8X, A2 8Z
- Škoda: Fabia 6Y, Fabia Combi 6Y, Fabia Praktik 6Y, Fabia Stufenheck 6Y, Fabia 5J, Fabia Combi 5J, Rapid 5J, Rapid Spaceback 5J, Roomster 5J, Roomster Praktik 5J

incl. spindle and thrust bearing for mechanical al actuation.

① Not suitable for Polo 1.2l '01-'04, without power steering!



VW  
Škoda  
Seat  
Audi

Part no.
301050L
301051L-11

## Compact bearing tool set

tool set for compact wheel bearing with 17 tonne hydraulic cylinder. This tool is used to install and remove a compact wheel bearing quickly, perfectly, safely and without damage. Allows direct work on the vehicle. The mechanical principle is transferable to the garage press.

Half shells:

- $\varnothing$  72 mm: Audi A1, A2, Seat Cordoba, Ibiza, Škoda Fabia, VW Polo
- $\varnothing$  78 mm: Ford Focus II, C-Max, S-Max, Mazda 3, Volvo C30, C70, S40, V50
- $\varnothing$  82 mm: Ford Mondeo 2007, Galaxy and S-Max 2006, Land Rover Freelander 2 2006, Volvo S80, V70, XC60, XC70 2006

① To be used with hydraulic foot pump 301120L.



Part no.  
302215L



VW  
Volvo  
Škoda  
Seat  
Mazda  
Land Rover  
Ford  
Audi



## Compact bearing tool set

tool set for compact wheel bearing with mechanical feed shaft.

This tool is used to install and remove a compact wheel bearing quickly, perfectly, safely and without damage. Direct work on the vehicle. The mechanical principle is transferrable to the garage press.

Half shells:

- $\varnothing$  72 mm: Audi A1, A2, Seat Cordoba, Ibiza, Škoda Fabia, VW Polo
- $\varnothing$  78 mm: Ford Focus II, C-Max, S-Max, Mazda 3, Volvo C30, C70, S40, V50
- $\varnothing$  82 mm: Ford Mondeo 2007, Galaxy and S-Max 2006, Land Rover Freelander 2 2006, Volvo S80, V70, XC60, XC70 2006

① Without hydraulic cylinder



Part no.  
302216L



Audi  
Ford  
Land Rover  
Mazda  
Seat  
Škoda  
Volvo



## Compact bearing tool set

tool set for compact wheel bearing with mechanical feed shaft.

This tool is used to install a compact wheel bearing quickly, perfectly, safely and without damage. Direct work on the vehicle. The mechanical principle is transferrable to the garage press.

Half shells:

- $\varnothing$  62 mm: Audi A2 1.2 TDI from '01, VW Lupo 1.2 TDI '99 - '05
- $\varnothing$  66 mm: Seat Cordoba IV from '05, Ibiza III from '04, Škoda Fabia '99 - '07 (without power steering), VW Fox 1.2 petrol engine from '04, Polo 9N '02 - '07 (without power steering)
- $\varnothing$  72 mm: Audi A1 from '10, A2 from '00, Seat Cordoba from '02, Ibiza from '01, Škoda Fabia from '99, Roomster from '06, VW Fox from '04, Polo 9N from '01 - '07

① The tool set is only for installing of the wheel bearing



Part no.  
302217L



Audi  
VW  
Škoda  
Seat





## Compact bearing tool set



for damage-free removal and fitting of wheel bearing/hub units with 85 mm diameter

VW

Suitable for:

- VW T5 from '04
- VW Touareg

Incl. spindles and pressure units for mechanical operation.



Part no.  
301051L

## Groove nut key



for rear axle MB Sprinter, VW LT

VW

Mercedes-Benz

- No. of pins: 6
- Width of pins: 8 mm
- Inner Ø pin: 61 mm
- Inner Ø key 50 mm
- Outer Ø key 70 mm
- Key height: 52 mm



Part no.  
10319L

## Wheel bearing set

Universal press-in and out set BMW, Mercedes-Benz with 5 adapter covers 68 - 116 mm

BMW  
Mercedes-Benz



Part no.  
302214L

## Wheel bearing tool set



Hydraulic tool set to install and remove the front wheel bearing on a Ford Transit built after '06.  
Incl. 32 t hydraulic cylinder

Ford

Direct work on the vehicle without removing the cardan shaft.

ⓘ To be used with hydraulic foot pump 301120L.



Part no.  
302218L

## Compact bearing tool



for damage-free replacement of compact bearings on

Volvo  
Mazda  
Ford

- Ford Focus II, C-Max
- Volvo
- Mazda 3



Part no.  
302208L



## Compact bearing tool

for damage-free replacement of compact bearings on

- Ford Focus II, C-Max, Mondeo
- Volvo C30, C70, S40, V50
- Mazda 3



Volvo  
Mazda  
Ford



Part no.  
**302209L**

## Supplementary set compact bearings

for wheel hub tool 301152L, for damage-free installation of bearing-hub units

- Ford C-Max, Focus II
- Ford S-Max, Galaxy '06
- Ford Mondeo '07
- Volvo S40, V50 '04
- Volvo C30, C70 '06
- Mazda 3 '03



Mazda  
Ford  
Volvo

① For use with bell and separation unit such as from 301155L

### Description

3-piece, 78 + 82 mm Diameter

Replacement pressure pad

Special nut M20 x 34

### Part no.

**301177L**

**301178L**

**301179L**

# Wheel Hubs

## Wheel Hubs removal tool

with 9 kg slide hammer Suitable for 4, 5 and 6-hole hubs.  
Pitch circle diameter 98 mm - 130 mm.

Up to M14 wheel bolts



Part no.  
**302221L**

## Wheel hub removal tool

with 6 kg hammer

- Suitable for 4- and 5-hole wheel hubs
- Hole pattern 98 to 125 mm
- Inner diameter 1: 73 mm in 9,5 mm depth
- Inner diameter 2: 55 mm in 45 mm depth
- For small vans and larger passenger cars e.g. SUVs
- M20 x 1.5 threaded body
- For up to M14 wheel bolts



### Description

Wheel Hubs removal tool

### Length

1060 mm

### Part no.

**301055L**



## Wheel hub removal tool



with 4 kg hammer.

- suitable for fLonge with 4- and 5-hole
- bolt circle from 100 to 115 mm
- for wheel bolts up to M14

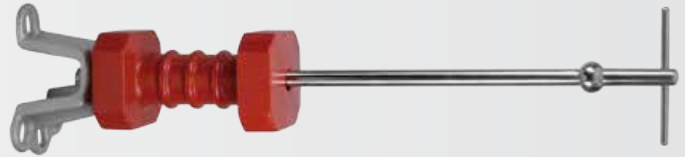

**Length**  
670 mm

**Weight**  
7 kg

**Part no.**  
**10107L**

## Wheel hub removal tool



suitable for wheels with 3, 4 and 5 apertured discs.  
Important e.g. during wheel bearing change on vehicles with ABS sensor.  
Can also be used to press the propeller shaft out of the joint.

Striking weight: 1,4 kg



ⓘ **Not suitable for hollow shafts, e.g. Passat 2,5 TDI**

**Part no.**  
**10106L**

# Drive Shafts

## IMPACT socket set, Double hexagon



High strength, for loosening the articulated shaft screws of various vehicles, e.g. Audi, BMW, Citroën, Ford, Opel, Mercedes-Benz, Nissan Škoda, Seat, Renault, VW, etc.

Content:

- 5 extra deep bi hex sockets 27 - 30 - 32 - 34 - 36 mm
- 3 Inner hex sockets 14 - 17 - 19 mm



**Part no.**  
**10186L**

## IMPACT-Steckschlüsseleinsätze, Zwölfkant



high-strength, for loosening the propeller shaft screws on different vehicles, e.g. Audi, BMW, Citroën, Ford, Opel, Mercedes-Benz, Nissan Škoda, Seat, Renault, VW etc.

Content:

- 5 extra deep bi hex sockets 27 - 30 - 32 - 34 - 36 mm
- 3 Inner hex sockets 14 - 17 - 19 mm



Opel  
Mercedes-Benz  
Ford  
BMW  
Fiat  
Nissan  
Seat  
Škoda  
Audi  
Toyota  
VW  
Citroën  
Renault  
Lancia  
Mercedes-Benz for Trucks!  
Subaru

**Description**  
8-piece

**Part no.**  
**10185L**

## IMPACT spanner sockets, Double hexagon, Extra deep



high-strength, for loosening the propeller shaft screws on different vehicles, e.g. Audi, BMW, Ford, Opel, Mercedes-Benz, Nissan, Seat, Škoda, Toyota, VW etc.



VW  
Škoda  
Seat  
Mercedes-Benz  
BMW  
Audi  
Fiat  
Ford  
Nissan  
Opel  
Subaru  
Toyota

Description	Profile	Size	Length	Part no.
3-piece	●	30, 32, 36 mm	78 mm	10190L
Passat 35, Golf VI	●	24 mm	78 mm	10189L
For Trucks Gearbox G2/24/26, e.g. MB Actros and BMW output shaft	●	27 mm	78 mm	10194L
VAG, BMW, Mercedes-Benz, Ford, Opel Toyota u.a.	●	30 mm	78 mm	10191L
Fiat, Ford, Mercedes-Benz, Nissan, Opel, Subaru u.a.	●	32 mm	78 mm	10192L
Fiat, Lancia, Renault u.a.	●	34 mm	78 mm	10196L
Fiat, Peugeot	●	35 mm	78 mm	10198L
Long version	●	36 mm	82 mm	10181L

## IMPACT screwdriver bit, Hexagonal socket



high-strength, for loosening the propeller shaft screws on different vehicles, e.g. VAG, BMW, Mercedes-Benz, etc.



Audi  
BMW  
Mercedes-Benz  
Seat  
Škoda  
VW

Profile	Size	Length	Part no.
○	17 mm	76 mm	10197L
○	19 mm	76 mm	10199L

## IMPACT spanner socket, Hexagonal, Short



Suitable for use with impact wrench, chrome-molybdenum steel, with groove and bore hole.

Also suitable for machinery use.



Size	Length	Part no.
40 mm	135 mm	07986SB

## IMPACT socket spanner bit, Double hexagon, Extra deep



with 12 flanks, highly durable, to release tighten drive shaft bolts on the Audi A4 from '01 and Audi A6 from '05 4-wheel drive with 6-speed manual gearbox 0A3 Fiat Ducato, Citroën Jumper, Peugeot Boxer, as well as ball joints on Renault Master, Opel Movano from '10 etc.



Audi  
Citroën  
Fiat  
Opel  
Peugeot  
Renault

Used equivalent to:  
• VAG OE number T40097

Profile	Length	Part no.
●	125 mm	05641L



## Special insert set



for groove nuts

- for the gentle loosening of groove nuts
- Tighten with torque
- for use with e.g. bearing screw connections
- 12.5 mm (1/2") drive, length 60 mm



① Further details can be found in the attached document

Description	Part no.
11-piece, 22-75 mm	10334L
10-piece, 26-88 mm	10335L

## Groove nut key



for removing and installing the drive shaft nut in Suzuki Jimny.



Suzuki

Description	Part no.
Groove nut key, Removal and installation of drive nuts	302213L

## Drive shaft pulling hammer



with universal tensioning strap for removing the drive shaft from the gearbox.



Part no.
302204L

## Screwdriver bit, Spline, Extra long



with universal tensioning strap for removing of the drive shaft from the gearbox.



Audi  
Seat  
Škoda  
VW

Profile	Size	Length	Part no.
○	M 8	800 mm	05208L
○	M 10	800 mm	05209L
○	M 12	800 mm	05214L

## IMPACT ball joint bit, Spline



especially for screwing work in spots that are difficult to reach on the drive shafts of many vehicles



Audi  
Seat  
Škoda  
VW

Description	Part no.
M8 x 130 mm	05215L
M10 x 130 mm	05216L

## Thread tapping set

for drive and propeller shafts, suitable for cleaning and re-cutting

- M24x1.50, M24x2.00, M22x1.00, M22x1.50, M20x1.50, M20x1.25, 13/16"x20 UNEF, 3/4"x20 UNEF



Description  
8-piece

Part no.  
10150L

## Drive shaft ejector

to press out the drive shaft on 4, 5 and 6-hole rims

- with hole circle diameter 98 mm - 130 mm



Part no.  
30220L

## Drive shaft set

for pressing out of the drive shafts for 5-hole rims

- with hole circle diameter 96 - 126 mm



ⓘ Mechanical

Part no.  
302201L

## Drive shaft set

with 12 ton hydraulic spindle

- for pressing out drive shafts, particularly where they are glued and rusty
- inner diameter 1: 73 mm in 9,5 mm depth
- inner diameter 2: 55 mm in 45 mm depth
- for larger passenger cars, SUVs and small delivery vans
- 4 and 5-hole wheel hubs for hole pattern with 98 - 125 mm diameter



ⓘ Hydraulic

D  
98 - 125 mm

Part no.  
10090L

## Drive shaft set

for pressing out of drive shafts for 4-/5-hole rims

- hole circle diameters from 96 - 126 mm, 10 t hydraulic cylinder



ⓘ Hydraulic, ideal for glued drive shafts!

Part no.  
302202L



## Drive shaft set

for pressing out of drive shafts for 4-/5-/6-hole rims

- with hole circle diameters from 130 - 160 mm,
- with 10 t hydraulic cylinder

E.g. for:

- Mercedes-Benz, Audi, Porsche, VW, Ford Transit.



Audi  
Ford  
Mercedes-Benz  
Porsche  
VW

① Hydraulic

Part no.  
**302203L**

## Drive shaft set

for removal and installation on the following BMW models:

- 3 series (E36, E46)
- 5 series (E39, E60, E61)
- 6 series (E64)
- 7 series (E65, E66, E67)
- X3 (E83)
- Z4 (E85)



BMW

Part no.  
**302200L**

## Drive shaft pull out tool set

for pulling the drive shaft out of the hub

- made of high-tensile steel
- Spindle in high-quality, standardised industry bearing
- incl. 6 pull sleeves with different threads:
  - M16 x 1.5 (Subaru)
  - M20 x 1.5 (VW Beetle, Touareg, Porsche Cayenne)
  - M22 x 1.5 (BMW 3 series E30, E46)
  - M24 x 1.5 (BMW 3 series E36 '90-'00, MB C Class W203)
  - M27 x 1.5 (BMW 5 series E34, E39, 7 series E32, E38, X5)
  - M30 x 1.5 (BMW 3 series E36, 5 series E34, 7 series E32)



Mercedes-Benz  
BMW  
Porsche  
VW  
Subaru

Description  
7-piece

Part no.  
**10112L**

## Drive shafts separating tool

for constant velocity joints without hole.

- Audi A2, A3, TT
- Porsche Cayenne
- Seat Leon, Ibiza, Altea
- Škoda Octavia, Fabia
- VW Bora, Fox, Golf V, New Beetle, Polo from '01, Touareg

Also suitable for other manufacturer having a drive shaft diameter of 21 - 32 mm

① To use only in combination with 10112L and 301208L



Seat  
Porsche  
Mercedes-Benz  
VW  
Škoda  
Subaru  
Audi

Description  
Drive shafts separating tool

Part no.  
**301514L**

## Propeller shaft separating tool

For withdrawing constant velocity joints from the front drive shaft.



Part no.  
**10115L**

## Threaded bolt set

for pushing off the outer constant-velocity joint on VAG vehicles, e.g. during changing of axle bellows. The tips can be turned to protect the shaft



Audi  
Seat  
Škoda  
VW

- M14 x 1,5 mm
- M16 x 1,5 mm

ⓘ **Joint and shaft must form a line as otherwise breakage is possible**

Description	Part no.
2-piece	<b>10160L</b>
M14 x 1,5 mm	<b>10161L</b>
M16 x 1,5 mm	<b>10162L</b>

## Safety pliers set, Extra narrow

for working on the engine, gearbox, drive shaft etc. Consisting of:

- 41430L - 30° angled, with central bore hole, extra slim, with serrated gripper jaws e.g. for removing the wheel-side joint when changing the sleeve
- 41431L - slightly angled, extra slim, with serrated gripper jaws, e.g. for outer circlips on constant-velocity joints
- 41432L - straight version with serrated gripper jaws, e.g. for outer circlips on drive shafts and gearboxes



VW  
Škoda  
Seat  
Opel  
Audi  
Fiat  
Mitsubishi

ⓘ **41430L with center hole for ideal hold of the rings**

Description	Length	Part no.
3-piece		<b>41435L</b>
30° angled - with center hole e.g. for removal wheel sided joint during renewal of boot	200 mm	<b>41430L</b>
Slightly angled -plaid pliers, e.g. for outer protection on constant-velocity joints	200 mm	<b>41431L</b>
Straight - plaid pliers head, e.g. fot outer protection of drive shaft and gearbox etc.	200 mm	<b>41432L</b>

## Pneumatic axle bellows spreader

for changing universal and original bellows - on axles and gears - directly at the vehicle. Lots of time saved, since the connecting links no longer have to be dismantled.

The axle bellows are pulled over the 8 spreading arms, opened gradually by pressing the button, and can then be pushed over the drive shaft link.

Suitable for links with a diameter of 20-135 mm (which includes all-wheel drive vehicles and small transporters)

- Sturdy aluminium design
- Operating pressure: 5 - 8 bar
- Connection: 1/4 inch NPT



Part no.  
**10003L**





## Universal axle bellows set



as replacement for axle bellows, in three stepped stages on the articulation side, 80 – 90 – 100 mm diameter (non-stretched) with inner retaining lug.

- diameter on the shaft side approx. 29 mm
- maximum length of the axle bellows approx. 128 mm
- with special grease for all kinds of articulated shafts
- with two fixing clamps for all standard axle shafts and articulations
- temperature-resistant from -60° to +150°C



ⓘ Very elastic, making it ideal for use with 10003L

Description	Part no.
80-90-100 mm, Shaft approx 29 mm	10440L

## Universal axle bellows set



as replacement for axle bellows, in three stepped stages on the articulation side, 80 – 75 – 88 mm diameter (non-stretched) with inner retaining lug.

- diameter on the shaft side approx. 22,3 mm
- maximum length of the axle bellows approx. 120 mm
- with special grease for all kinds of articulated shafts
- with two fixing clamps for all standard axle shafts and articulations
- temperature-resistant from -60° to +150°C



ⓘ Very elastic, making it ideal for use with 10003L

Description	Part no.
60-75-88 mm, Shaft approx 22,3 mm	10441L

## Axle bellows pliers



for axle tubes without steps or lugs, e.g. for VAG, BMW, Mercedes-Benz and Toyota.



BMW  
Audi  
Mercedes-Benz  
Škoda  
Toyota

Part no.  
41461L

## Axle bellows pliers



for infinite and earless clamps on radiators, fuel hoses, air filter housings on the Opel Astra as well as axle bellows on new VW and Mercedes-Benz types



Audi  
Seat  
Škoda  
VW  
Mercedes-Benz  
Opel

Length	Part no.
235 mm	41460L



## Axle bellows pliers

with blank holder, prevents the bellows closure becoming loose, for universal use e.g. for VAG, Opel, BMW, Mercedes-Benz, Honda, Nissan, Mazda etc. e.g. during work on the fuel filters and water pump.



① With additional square 12,5 mm (1/2")

Length  
235 mm

Part no.  
61790L



Mazda  
Honda  
BMW  
Audi  
Mercedes-Benz  
Nissan  
Opel  
Seat  
Škoda  
VW



## Axle bellows pliers

for attaching the lug clamps (Oetiker system). For use at the side where space is tight e.g. on axle bellows, radiator and fuel hoses etc.



Length  
245 mm

Part no.  
61791L



## Collet chuck

for pressing high-strength stainless steel clamps to drive shafts taking the torques prescribed by the manufacturer into account

- steel body with smooth surface
- 10 mm (3/8") drive



① For professional tightening with torque wrench

Length  
250 mm

Part no.  
61780L



## Hose strap mounting device

for endless hose bands - for clamping, tightening and cutting. Tightening either with the T-handle or 13 mm socket spanner



Length  
110 mm

Part no.  
61740L



## Clamping strap

for attaching drive shaft sleeves

- Metal strap made of stainless steel
- 6 x 280 mm
- 20 pieces



① Ideal for use with 61740L!

Part no.  
61743L





## Hose clamp set



3 m endless strap (8 mm wide), can be worked into clamps of any length, with 8 clamping closures

- Stainless



Part no.

61742L

## Steering / Tie Rods

### Tie rod tool



For cars, for loosening and turning difficult-to-reach tie rods with optimum force transmission.

Suitable for tie rods of 14-20 mm diameter. The wide support surface prevents damage to the tie rod.

Length adjustable from 100 - 260 mm.



Description

14 - 20 mm Diameter

Part no.

10027L

### Tie rod tool



for trucks, for loosening and turning stiff steering tie rods with good force distribution.

Suitable for steering tie rods from 40 - 50 mm diameter. The wide contact surface prevents damage to the steering tie rod

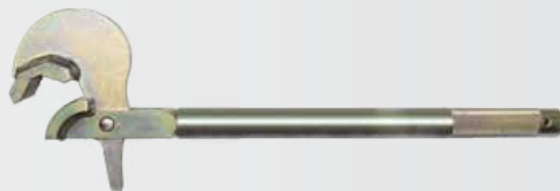

Description

Complete set 40 - 50 mm

Spare head 40 - 50 mm

Insert 25 - 40 mm

Part no.

301064L

301066L

301065L

### Wheel alignment wrench



facilitates wheel alignment on the rear axle.

- incl. two interchangeable XZN tripe squared bits, sizes M10 and M12
- material: Chrome-vanadium
- easily allows hard-to-reach adjustment screws to be loosened
- allows work to be done quickly, precisely, and with little effort
- two-bend design
- with ergonomic handle for increased working comfort

Suitable for Mercedes-Benz C-Class (C 203) and S-Class, as well as for older models with under-body cladding and vehicles with fill level sensors.



Part no.

302353L

## Universal steering knuckle joint tool

for the fast and professional removal and fitting of hexagon steering knuckle axial joints with a diameter of 33 - 41 mm directly on the vehicle without removing the steering gear.



Part no.  
10117L

## Steering knuckle joint tool

for the professional and fast replacement of steering knuckle axial joints on passenger cars and light trucks



- automatic clamping of joint heads
- longer steering rod ties can be mounted easily thanks to the open design
- save up to 3 hours
- 2 head diameters for steering tie rods from 32 - 37 mm and 37 - 42 mm diameter
- optional drive through actuation tools with 12,5 mm (1/2") drive or spanner width 30 mm



### Description

### Part no.

3-piece, 32 - 42 mm	10116L
Pressure head holding device	10116L-1
Pressure head 32 - 37 mm	10116L-2
Pressure head 37 - 42 mm	10116L-3
Pressure head 42 - 46 mm	10116L-4

## Ball-joint extractor

For removing the ball joints from the steering knuckle, e.g. Steering rod, stabilizer and the like.

- clamping height up to 50 mm
- fork opening 20 mm



### Description

### Part no.

Short fork, Fine thread spindle	10005L
Long fork	10006L

## Ball-joint remover

for pushing the ball pin out when removing ball joints from the stabiliser, steering knuckle, steering lever etc.

- Clamping range up to 55 mm
- Width 22 mm



- Audi
- BMW
- Fiat
- Ford
- Mercedes-Benz
- Nissan
- Opel
- Peugeot
- Renault
- Rover
- Saab
- Seat
- Škoda
- Toyota
- Volvo
- VW

### Description

### Part no.

Clamping range can be adjusted in 2 fixed stages, 30 + 55 mm, with fine thread spindle	10008L
--	--------



## Ball-joint remover



Extra large, forged, universally applicable for trucks.  
The fork extension serves to drive the tool with a targeted hammer strike.

- Fork opening 20 mm



Description	Part no.
Extra large with fork extension	10007L

## Ball-joint remover set



with fine-thread spindles.

- E23 x H55
- E28 x H55
- E34 x H63



Mercedes-Benz  
VW  
Audi  
Fiat

① Especially suitable under cramped conditions

Description	Part no.
3-piece	10015L
23 mm wide, 55 mm Useful height, for almost all Passenger cars, particularly for BMW E39 and MB W210	10010L
28 mm wide, 55 mm useful height especially for Audi A4, A6, A8, VW Passat etc., Opel Movano, MB W203	10011L
34 mm wide, 63 mm useful height especially for VW "LT" from year '96, Mercedes-Benz Sprinter from year '95, Fiat Ducato etc.	10012L

## Ball joint remover set



with interchangeable fork system, allows disassembly of ball joints in various sizes.

- Suitable for cars, light trucks and SUVs
- 5 interchangeable forks 20-22-24-27-30 mm
- Max. extractor width 125 mm



① Heavy version

Description	Part no.
6-piece	10019L

## Ball-joint remover



for universal use with trucks/commercial vehicles

- with two seats 24 + 32 mm width
- with oil hydraulic spindle for easy and fast work
- clamping range: 55 - 105 mm



① Warning: Clean and lubricate the screw with grease (MOS2), before using it.

Description	Part no.
24 + 32 mm Width	10004L

## Adapter



for the clamping screw of the tie rod, e.g. Audi A4, A6, A8, VW Passat, Škoda Superb, Seat Exeo



Škoda  
Audi

Description	Part no.
Adapter for clamping screw	301169L

## Gauge set for steering tie rods

allows the replacement of faulty steering tie rod ends without axle alignment.

### Contents:

- 1 basic device with clamp
- 3 callipers 10 mm + 12 mm + long
- 1 calliper 17 mm for VW
- 1 fixing unit
- 1 depth sensor

Suitable for all common vehicle manufacturers

① Also suitable for VAG four-link suspension



Part no.

10016L

## Steering wheel spirit level

for the exact levelling of the steering wheel during axle alignment and work on the steering column

- fast installation
- simple adjustment on the steering wheel
- easy to read-off
- for universal use with passenger cars, light trucks and trucks
- false steering wheel settings are avoided by using the steering wheel setting gauge



Part no.

09533L

# Shock Absorber

## Pneumatic spring strut compressor

- max. 1,226 kg
- Dual-position carrier plate for different suspension lengths
- Protective cage with safety lock
- Pneumatic cylinder with safety shutoff valves
- Pedal and safety cover with safety valves
- Swivel side arms
- Small and medium-sized supports matching most struts are included in the scope of delivery (for spring diameters 78 - 130 mm and 125 - 205 mm)
- With suspension piston rod holder



Part no.

10277L

## Pneumatic spring strut compressor

High-performance pneumatic spring strut compressor

- max. 2,452 kg
- Dual-position carrier plate for different suspension lengths
- Protective cage with safety lock
- Pneumatic cylinder with safety shutoff valves
- Pedal and safety cover with safety valves
- swivel side arms
- small and medium-sized supports matching most struts are included in the scope of delivery
- (for spring diameters 78 - 130 mm and 105 - 182 mm)
- Suspension piston rod holder



Part no.

10278L



## Spring retainer

Set of spring retainers for:

- Mercedes-Benz A Class (W169)
- Mercedes-Benz B Class (W245)
- Mercedes-Benz C Class (W204) Built 2007 - 2010
- Mercedes-Benz E Class (W211 and W212)



Mercedes-Benz



Part no.  
10280L

## Spring retainer

For:

- Mercedes-Benz C Class (W204) from '10



Mercedes-Benz



Part no.  
10281L

## Spring retainer

For left-twist springs from  $\varnothing$  105 mm to 187 mm.

For:

- Renault Koleos, Laguna
- Nissan Qashqai



Renault  
Nissan



Part no.  
10282L

## Spring retainer

For right-twist springs from  $\varnothing$  105 mm to 187 mm.

For:

- Renault Mégane, Clio
- Citroën C2, C3, Peugeot 207, 307
- Mercedes-Benz B Class (W245)
- Mercedes-Benz C Class (W204)
- Mercedes-Benz E Class (W211 and W212)
- Fiat Multipla



Renault  
Mercedes-Benz  
Fiat  
Citroën  
Peugeot



Part no.  
10279L

## Spring retainer

Upper spring retainer for Japanese vehicles like:

- Toyota
- Honda etc.



Toyota  
Honda



Part no.  
10283L

## Spring retainer

Upper spring retainer, front suspension:

- Porsche Cayenne type 9P: 12/2002-05/2010
- VW Touareg type 7L: 10/2002-02/2010
- Audi Q7 type 4L: 09/2005-03/2015



Porsche  
VW  
Audi



Part no.  
10284L

## Vice

short version.  
To use with 10277L and 10278L!



Part no.  
**10286L**

## Vice

long version.  
To use with 10277L and 10278L!



Part no.  
**10285L**

## Spring tensioning set



for fast and professional removal and installation of McPherson struts, with safety pin.

The set includes the basic tool, two coated disc pairs with polyurethane safety insert and a safety rope.

- maximum pressure: 1.800 kg
- disc pair for spring diameter up to 120 mm
- disc pair for spring diameter up to 200 mm



ⓘ We recommend the application of hand - or air ratchets

Description	Druckkraft	Part no.
5-piece	1,8 t	<b>10207L</b>

## Universal spring tensioner set



for fitting and removing screw springs.  
Clamping range 300 mm



ⓘ only for exporting outside the EU!

Description	Part no.
2-piece	<b>10255L</b>

## Universal spring tensioner set



makes one-hundred percent spring cover and thus maximum safety possible

- clamping range to 240 mm



Description	Part no.
3-piece	<b>10250L</b>





## Telescopic spring tensioner



Mercedes-Benz

for Mercedes-Benz vehicles of the series  
116 - 123 - 124 - 126 - 129 - 140 - 170 - 201 -  
202 - 208 - 210.

The short design of the inner tensioner makes fast work possible even under cramped conditions.  
The telescopic body allows stepless adjustment to the respective spring length.  
With two pairs of clamping lugs for spring diameters 80 - 119 mm and 89 - 141 mm



Description	Part no.
5-piece	10210L
Roll pin	10211L

## Spring tensioner set



for inner springs on double wishbones/multi-link wheel suspension systems e.g. for BMW (1-series/3-series), Mercedes-Benz, Škoda, VW etc.

Renault  
Seat  
Suzuki  
Škoda  
VW  
Volvo  
Toyota  
Mercedes-Benz  
Withsubishi  
Peugeot  
Mazda  
BMW  
Chevrolet  
Chrysler  
Citroën  
Hyundai  
Honda  
Ford  
Kia

- spring tensioner basic unit
- with 2500 kg / 25000 Nm max. pressure force
- torque rod, 100 Nm
- 2 spring brackets 90 - 120 mm diameter
- 2 spring brackets 120 - 140 mm diameter



① Application instructions, model specifications and years of construction must always be followed!  
Download on [www.tool-is.com](http://www.tool-is.com)

Description	Pressure capacity	Part no.
6-piece	2,5 t	10220L

## Spring tensioning set



for McPherson struts, for fast and professional removal and installation, with safety pin.

- Basic tool + 2 coated disc pairs for spring diameters from 80-195 mm
- Clamping range ca. 5 - 35 cm



① Includes 10225-1 and 10225-2

Description	Pressure capacity	Part no.
5-piece	1,10 t	10200L
Universal use for spring diameter 80-145 mm		10225L-1
Universal use for spring diameter 145-195 mm		10225L-2



## Spring retainer

for use with spring tensioner 10200L and devices with the same connector.

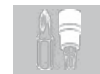

① Depending on type of car please order pairwise!

Description	Part no.
Universal use for spring diameter 80-120 mm	10225L-0
Universal use for spring diameter 80-145 mm	10225L-1
Universal use for spring diameter 145-195 mm	10225L-2
Universal use for spring diameter 140-170 mm	10225L-3

## Spring retainer

for use with spring tensioner 10200L and devices with the same connector.



Audi



① Depending on type of car please order pairwise!

Description	Part no.
for Audi A4, A6 and conical spring 80-145 mm	10225L-5
for BMW E39, E46, Renault Mégane II and Toyota Avensis	10225L-6
for Mercedes-Benz C Class	10225L-7
for Mercedes-Benz E Class (W211)	10225L-8
for Mercedes-Benz C Class (W204 and W205) and E Class (W207)	10225L-13
for Nissan Qashqai (left-turning) 145-195 mm	10225L-12

## Spring retainer

for use with spring tensioner 10200L and devices with the same connector.



Peugeot  
Citroën



① 1 pair

Description	Part no.
for Peugeot Break and Citroën C15	10225L-9



## Shock Absorber fitting tool set



For the fitting and removal of shock absorbers with buffer spring.

The piston rod is pulled into the shock absorber by a buffer spring inside the shock absorber. This means that the springs cannot be tensioned enough with most standard spring tensioners, making fitting very difficult. The special design of the shock absorber fitting tool allows the piston rod to be pulled up properly without jamming and fixed in place without damage in the end stop position using a universal clamping piece with V-shaped plastic inserts. This simple process allows repairs to be carried out by a fitter, saving both time and costs.

Vehicle models: BMW, Fiat, Ford, Mercedes, Nissan, Peugeot, Toyota, etc.

Scope of delivery:

- Special basic element for pulling tool
- Patented piston rod pulling tool with M40x1mm thread and ball bearing
- Special clamping piece with V-shaped plastic inserts
- Two additional inner hexagon screws M8x60mm
- 6 mm hexagon socket with allen key



**Weight**  
2,95 kg

**Part no.**  
**10276L**

## Pin wrench set

for shock absorber screws on VAG vehicles

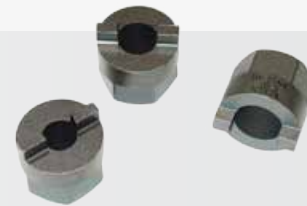

Audi  
Seat  
Škoda  
VW

### Description

### Part no.

3-piece set  
3,5 x 10,5 x S 19  
3,5 x 12,5 x S 22  
5,0 x 14,5 x S 22

**10300L**  
**10301L**  
**10302L**  
**10303L**

## Pin wrench

for shock absorber screws on Mercedes-Benz series 203, C-Class from model year 2000



Mercedes-Benz

**Part no.**  
**10304L**

## Shock absorber wrench

with 5 and 6 mm special profile for VW, Audi, Ford, Opel, etc., for the retention of the piston-rod when loosening / tightening the shock absorber screwed connection.

By means of precise placement on the shock absorber piston, sliding becomes almost impossible.



Ford  
Opel  
VW  
Audi

**Part no.**  
**10270L**

## Shock Absorber

for the professional loosening and tightening of the shock absorber nuts on the strut dome bearing. Suitable for all common vehicles.

- Standard ratchet with 21 mm bi-hexagon socket, switchable
- 7 inner-hexagon bits for 21 mm socket 16 - 17 - 18 - 19 - 21 - 22 - 24

10 arrester inserts with 12.5 mm (1/2") socket:

- inner-hexagon bits, long in 6 - 7 - 8 mm
- T50 (Opel Astra H)
- special bits, oval in 5x8 - 6x8 - 7.1x9.6 mm e.g. (Porsche Cayenne S, VW Touareg)
- hexagon bit, long in 7 mm (Mercedes-Benz Vaneo) - 8 mm for (BMW) - 9 mm (Opel Corsa B, Astra F/G, Vectra B)



**VW**  
Porsche  
Opel  
Mercedes-Benz  
BMW



### Description

18-piece

Support insert

### Part no.

10365L

10365L-6

## Open socket spanner set

Chrome-vanadium

Contains:

- open sockets 8 - 10 - 11 - 12 - 13 - 14 - 15 - 16 - 17 - 18 - 19 mm
- extension for shock absorber piston rod
- open ratchet wrench
- Adapter for using the ratchet as a standard ratchet with 10 mm (3/8")



### Description

17-piece

### Part no.

06540L

## Spreading tool

with 2 exchangeable spreading inserts (5 and 8 mm deep) for different splay angles and guide bolt (8, 10 and 12 mm) e.g. for the shock-absorber seat on the wheel bearing housing during shock-absorber replacement, ball-and-socket joint seat at the wishbone/A-frame arm during removal of the suspension strut etc.

Slipping is almost impossible thanks to optimum fixing of the tool with bolts inserted into the screw holes. The spreader is pressed into the opening by means of a spindle with 13 mm exterior hexagon - there is no longer any need to use a hammer. This reduces the risk of material fatigue and failure - particularly in the case of aluminium steering parts.



### Part no.

10305L

## Assortment of spreaders

the assortment consists of 10308L + 10310L and is suitable for fitting struts to knuckle clamping holes on VW, Audi, Seat, Škoda, BMW, Citroën, Ford, Renault, Peugeot and Japanese vehicles



**Audi**  
**VW**  
**BMW**  
**Citroën**  
**Ford**  
**Peugeot**  
**Renault**  
**Seat**  
**Škoda**

### Description

8,2 x 5,5 mm and 7 x 5 mm Spread dimension

8,2 x 5,5 mm Spread dimension

7 x 5 mm Spread dimension

### Part no.

Z610

10308L

10310L



## Camber spirit level

- Makes it possible to replace the MacPherson strut without adjusting camber angle and thus saves lots of time
- The magnetic side of the spirit level is attached to the brake disc or wheel hub and the measured value is read off
- After repairs, the wheels are aligned to the previous measured value



ⓘ No tracking necessary

Part no.  
10240L

## Camber spirit level



helps to record the strut angle before removal in order to reinstall the strut at exactly the same angle later.

2 adjustment possibilities:

- rough adjustment through 180° folding mechanism
- then fine adjustment using setting screw



ⓘ No tracking necessary

Part no.  
10246L

## Camber setting tool set



For readjusting the camber values on the front axle.  
Application via the spring dome bearing.

BMW

Suitable for:

- 1 series ( E81, E82, E87, E88)
- 3 series (E46, E90, E91, E92, E93)
- 5 series (E39, E60, E61)
- 6 series (E63, E64)
- 7 series (E38, E65, E66, E67)
- X3 (E83)
- X5 (E53)
- Z4 (E85, E86)



ⓘ Before setting the camber strike the locating pin of the dome bearing down and out!

Part no.  
10243L

## Camber setting key



The tool is clamped between the rim and the body (wing) and the correct camber is set by turning the hexagon nut. The tool has been designed in such a way that a mechanic can carry out the work.

Seat  
VW



Description

Part no.

- 75 mm version for VW Golf, Jetta, SEAT Toledo and identical vehicles
- 85 mm version for VW Polo from 1995, SEAT Cordoba and identical vehicles

10241L  
10242L

## Jointed hook spanner

DIN  

adjustable from 35 - 60 mm

For use on groove nuts DIN 1804 - also ideal for adjusting steering head bearings on motorcycles



Length

175 mm

Part no.

S1226

## Hook spanner

DIN 

75 mm opening

For use on groove nuts DIN 1804



Length

280 mm

Part no.

S1225

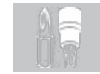

# WHEEL / TYRE





# WHEEL / TYRE

# 502-523



▶ Hydraulic Jacks / Jack Stands

504-505



▶ Wheel nut tools

505-512



▶ Tyre servicing tools

513-523





## Scissors-type jack



with crank

- lifting power: 100 - 360 mm
- heavy load: 1500 kg



Carrying load	Lifting height min.	Lifting height max.	Part no.
1500 kg	100 mm	360 mm	22201L

## Trolley Jack



- carrying load 2,000 kg
- single Lifting height: 135 - 335 mm
- with casters and safety valve



Carrying load	Lifting height min.	Lifting height max.	Part no.
2000 kg	135 mm	335 mm	20700L

## Trolley Jack



Racing look

- hydraulic double piston mechanism
- quick lifting - effortless
- very low in weight but sturdy
- with rubber pad on bearing area
- with rod protection on piston rod
- lifting height: 95 - 440 mm
- carrying load: 2000 kg
- made of aluminum
- for lowered vehicles



Carrying load	Lifting height min.	Lifting height max.	Part no.
2000 kg	95 mm	440 mm	20740L

## Trolley Jack



- hydraulic
- steel wheels
- pump rod protection to stop it bumping against the vehicle
- lifting height min. 140 mm, max. 520 mm
- carrying load 3000 kg



Carrying load	Lifting height min.	Lifting height max.	Part no.
3000 kg	140 mm	520 mm	20731L

## Trolley Jack



- hydraulic double piston mechanism
- quick lifting - effortless
- very low in weight but sturdy
- with rubber pad on bearing area
- with rod protection on piston rod
- lifting height: 98 - 535 mm
- carrying load: 3000 kg



Carrying load	Lifting height min.	Lifting height max.	Part no.
3000 kg	98 mm	535 mm	20741L



## Trolley Jack

made of aluminium

Hydraulic, with rubber pad contact surface, steel wheels and transport handle

① **Extremely light**



Carrying load	Lifting height min.	Lifting height max.	Part no.
1500 kg	125 mm	340 mm	20710L

## Hydraulic jack

with safety valve.



Carrying load	Lifting height min.	Lifting height max.	Part no.
2000 kg	155 mm	295 mm	20601L
5000 kg	215 mm	430 mm	20602L
12000 kg	215 mm	415 mm	20605L
20000 kg	240 mm	470 mm	20606L

## Jack stand

with three standing legs



Description	Carrying load	Height min./max.	Part no.
1 pieces	3000 kg	320 / 490 mm	20400L
1 pair (2 pieces)	3000 kg	320 / 490 mm	20405L

## Jack stand

with one-handed operation, four bases



Description	Carrying load	Height min./max.	Part no.
1 pair (2 pieces)	2000 kg	265 / 420 mm	20455L
1 piece	2000 kg	265 / 420 mm	20450L
1 pair (2 pieces)	3000 kg	280 / 420 mm	20465L
1 piece	3000 kg	280 / 420 mm	20460L
1 pair (2 pieces)	6000 kg	385 / 600 mm	20475L
1 piece	6000 kg	385 / 600 mm	20470L

## Wheel nut tools

### Wheel nut wrench

based on DIN 899

- extremely stable design made from high-quality chrome vanadium
- with 22 mm turning pin (length 600 mm)
- mat chrome plated
- in practical fabric bag



Description	Size 1	Size 2	Part no.
	24 mm	27 mm	02245L
	27 mm	32 mm	02247L
	30 mm	32 mm	02251L
Cross bar			02242L



## Wheel nut wrench



based on DIN 899

- extremely stable design made from high-quality chrome vanadium
- matt chrome plated



Size 1	Size 2	Length	Part no.
24 mm	27 mm	400 mm	02220L
27 mm	32 mm	400 mm	02222L
30 mm	32 mm	400 mm	02226L

## Wheel nut key



interchangeable, extendable from 370 to 530 mm



Size 1	Size 2	Part no.
17 mm	19 mm	02105SB

## Spider wrench



chrome-plated, polished, with reinforced central plate, 170 mm arm length



① Passenger cars

Size 1	Size 2	Size 3	Size 4	Part no.
17 mm	19 mm	21 mm	1/2"	02100L

## Spider wrench



DIN 899



① Passenger cars

Description	Length	Part no.
Silver painted 17 x 19 x 22 mm x 13/16"	355 mm	02102L
Chrome-plated, 17 x 19 x 22 x 13/16"	355 mm	02200L

## Spider wrench



- foldable
- reinforcement of levering force possible thanks to sliding joint
- maximum arm length 400 mm
- ideal for deep-set wheel nuts



① Passenger cars

Size 1	Size 2	Size 3	Size 4	Part no.
17 mm	19 mm	21 mm	1/2"	02210L

## LCV wheel nut wrench

- with reinforced central plate
- leg length 350 mm



① For Trucks!

Size 1	Size 2	Size 3	Size 4	Length	Part no.
24 mm	27 mm	32 mm	3/4"	700 mm	02450L

## Spider wrench

Industrial version, forged, hardened, 340 mm arm length



① For Trucks!

Size 1	Size 2	Size 3	Size 4	Length	Part no.
24 mm	27 mm	32 mm	3/4"	660 mm	02400L

## Wheel nut impact sockets

- fully plastic-encapsulated
- extra thin-walled
- optimum power transmission
- to ensure alloy wheels are no longer scratched
- made of high-strength chrome-molybdenum steel

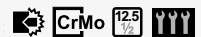

① Impact-proof!

Description	Part no.
3-piece, 17 - 19 - 21 mm	07870L
5-piece, 15 - 17 - 19 - 21 - 22 mm	07865L

## Wheel nut socket

suitable e.g. for Hyundai and Kia with characteristics as follows:

- impact-proof
- star profile
- fully encapsulated in plastic
- optimum force transmission
- rims no longer become scratched

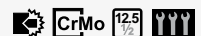

Hyundai  
Kia

① Impact-proof!

Size 1	Length	Part no.
21 mm	80 mm	07888SB

## Wheel nut socket

Especially for Mercedes-Benz.

- wheel nut impact socket
- star shaped
- with protective cap to ensure alloy wheels are no longer scratched



Mercedes-Benz

① This wheel nut socket is only to be used with Mercedes-Benz!

Description	S 1	Length	Part no.
Star profile	17 mm	88 mm	07887L



## Wheel nut socket



Mercedes-Benz  
Smart

- fully plastic-encapsulated
- extra thin-walled
- impact-proof
- optimum power transmission
- to ensure alloy wheels are no longer scratched
- made of high-strength chrome-molybdenum steel



**Impact-proof!**

Description	Size 1	Length	Part no.
e.g. Smart fortwo	15 mm	85 mm	<b>07878L</b>
	17 mm	85 mm	<b>07871L</b>
	19 mm	85 mm	<b>07872L</b>
	21 mm	85 mm	<b>07873L</b>
e.g. Opel Insignia, Saab 9-5 II, Toyota Land Cruiser	22 mm	85 mm	<b>07879L</b>

## IMPACT socket, Hexagonal socket



can also be used for removing the front and rear wheels on motorbikes, chrome-vanadium, 12.5 mm (1/2") drive, permanently pressed in, suitable for maximum loads



BMW  
Honda  
Suzuki  
Yamaha  
Ducati  
Kawasaki  
Moto Morini

Profile	Size	Length	Part no.
○	22 mm	53 mm	<b>05111L</b>
○	24 mm	53 mm	<b>05112L</b>

## Wheel nut sockets, Hexagonal



- impact-proof
- fully encapsulated in plastic
- extra thin walls
- optimum force transmission
- rims and bolts no longer become scratched
- with groove and bore hole

Special length, especially suitable for drop centre rims. Any falsification of torque caused by putting extensions together is avoided



**Impact-proof!**

Description	Part no.
3-piece, 17 - 19 - 21 mm	<b>07880L</b>

## Wheel nut sockets, Hexagonal



- impact-proof
- fully encapsulated in plastic
- extra thin walls
- optimum force transmission
- rims and bolts no longer become scratched
- with groove and bore hole

Special length, especially suitable for drop centre rims. Any falsification of torque caused by putting extensions together is avoided



**Impact-proof!**

Size	Length	Part no.
17 mm	150 mm	<b>07881L</b>
19 mm	150 mm	<b>07882L</b>
21 mm	150 mm	<b>07883L</b>

## IMPACT spanner socket, Hexagonal, Long

Suitable for use with impact wrench, with groove and bore hole for ball, chrome-molybdenum  
Suitable for Scania and Volvo utility vehicles.



Scania For Trucks!  
Volvo For Trucks!



Size	Length	Part no.
33 mm	90 mm	07861L

## Spiral groove sockets, Spiral groove, Extra long

for loosening heavily damaged wheel nuts and bolts. The high-alloy special steel combined with the aggressive groove profile makes it possible to loosen all screws.

12,5 mm (1/2") drive

ca. 150 mm long inserts 17 - 19 - 21 mm + striking pin



Description	Length	Part no.
4-piece	150 mm	07890L

## Helical groove insert, Spiral groove, Extra long

to release badly damaged nuts and bolts. The high-alloy special steel, combined with the aggressive groove profile, loosens all bolts.



Size	Length	Part no.
17 mm	150 mm	07890L-17
19 mm	150 mm	07890L-19
21 mm	150 mm	07890L-21
22 mm	150 mm	07890L-22

## Wheel lock removal tool

for quick and easy removal of rim locks. The conical bushings are forced onto the lock and loosened by using a wheel nut key. The locks stay protected from damage.

- with 8 bushings, size 16,8 - 25,8 mm

Every set includes a comprehensive users manual.



Description	Part no.
10-piece	02380L
Replacement bushing 18 mm (16,8 - 18,8 mm)	02380-18
Replacement bushing 19 mm (17,8 - 19,8 mm)	02380-19
Replacement bushing 20 mm (18,8 - 20,8 mm)	02380-20
Replacement bushing 21 mm (19,8 - 21,8 mm)	02380-21
Replacement bushing 22 mm (20,8 - 22,8 mm)	02380-22
Replacement bushing 23 mm (21,8 - 23,8 mm)	02380-23
Replacement bushing 24 mm (22,8 - 24,8 mm)	02380-24
Replacement bushing 25 mm (23,8 - 25,8 mm)	02380-25





## Wheel lock nut set VW



Replacement key for original wheel locks when the original key is no longer available or forgotten when changing the wheel. The key set allows the original lock nuts to be released and tightened without damage. Suitable for vehicles up to 2012.

Includes the following sizes:

51/6PT; 52/7PT; 53/8PT; 54/9PT; 55/10PT;  
56/11PT; 57/12PT 58/13PT; 59/14PT; 60/15PT;  
61/16P; 62/17PT;  
ABC0/10PT; ABC1/11PT; ABC2/13PT; ABC3/14PT; ABC4/15PT;  
ABC5/16PT; ABC6/17PT; ABC7/19PT; ABC8/20PT; ABC9/21PT  
Wheel lock socket, 17mm x 85mm, 12,5 mm (1/2")DR



### Description

23-piece

### Part no.

**02382L**

## Wheel lock nut set VW



Replacement key for original wheel locks when the original key is no longer available or forgotten when changing the wheel. The key set allows the original lock nuts to be released and tightened without damage. Suitable for vehicles from year of construction 2012.

Includes the following sizes:

521, 522, 523, 524, 525, 526, 527, 528, 529, 530  
531, 532, 533, 534, 535, 536, 537, 538, 539, 540



### Description

20-piece

### Part no.

**02383L**

## Wheel lock nut set BMW



Replacement key for original wheel locks when the original key is no longer available or forgotten when changing the wheel. The key set allows the original lock nuts to be released and tightened without damage. Suitable for vehicles up to 2012.

Includes the following sizes:

30/13PT; 31/15PT; 32/16PT; 33/17PT; 34/18PT;  
35/19PT; 36/20PT; 37/21PT; 38/22PT; 40/23PT;  
11/15PT; 12/14PT; 13/16PT; 14/12PT; 15/11PT;  
16/10PT; 17/7PT; 18/13PT; 19/8PT; 20/9PT  
Wheel lock socket, 17mm x 85mm, 12,5 mm (1/2")DR



### Description

21-piece

### Part no.

**02381L**

## Wheel lock nut set BMW



Replacement key for original wheel locks when the original key is no longer available or forgotten when changing the wheel. The key set allows the original lock nuts to be released and tightened without damage. Suitable for vehicles from year of construction 2012.

Includes the following sizes:  
41, 42, 43, 44, 45, 46, 47, 48, 49, 50,  
51, 52, 53, 54, 55, 56, 57, 58, 59, 60



### Description

20-piece

### Part no.

02384L

## Wheel lock nut set Mercedes-Benz



Replacement key for original wheel locks when the original key is no longer available or forgotten when changing the wheel. The key set allows the original lock nuts to be released and tightened without damage. Suitable for vehicles from year of construction 2012.

Includes the following adapters:  
301, 302, 303, 304, 305, 306, 307, 308, 309, 310,  
311, 312, 313, 314, 315, 316, 317, 318, 319, 320,  
321, 322, 323, 324, 325, 326, 327, 328, 329, 330



### Description

30-piece

### Part no.

02385L

## Tool for loosening wheel nut caps

for the easy removal of wheel nut caps without damaging the wheel rim.

- especially suitable for aluminium rims
- with gripping claw made of spring steel and T-handle for easy usage
- up to 6 wheel nut caps can be stored inside the handle after loosening
- suitable for wrench size of up to 22 mm



Audi  
Opel  
Seat  
Škoda  
Vauxhall  
VW

### Length

172 mm

### Part no.

02305SB

## Stud bolt thread repair kit



for re-cutting or cleaning stud bolts or screws. The cutting jaws can be separated to place the tool on an undamaged thread section. The thread can then be cleaned or re-cut. Especially suitable for wheel bolts or wheel screws.

For outer thread: M12x1.25, M12x1.50, M14x1.50



### Part no.

02371L

## Thread tapping set

for cleaning and recutting wheel screws and threads. Complete with 10 mm (3/8") seats for mounting by ratchet.

- M12 x 1,25 mm
- M12 x 1,50 mm
- M14 x 1,50 mm



⚠ **Rusty and faulty threads cause false torque values and can lead to loose wheels!**

Description	Part no.
12-piece	02370L

## Round threading die

HSS TITANIUM nitrified  
standard outer diameter



HSS YYY

Thread	Thread pitch	Width	Part no.
M12	1,25	38 mm	02370L-1
M12	1,50	38 mm	02370L-2
M14	1,50	38 mm	02370L-3

## Die holder seat

extension and die holder



CrV YYY

Description	Part no.
Die holder seat for 10 mm (3/8")	02370L-8

## Hand tap

HSS TITANIUM nitrified



HSS YYY

Thread	Thread pitch	Length	Part no.
M12	1,25	82 mm	02370L-4
M12	1,50	82 mm	02370L-5
M14	1,50	86 mm	02370L-6

## Tap seat

7 mm for 10 mm (3/8")



CE CrV YYY

Description	Part no.
7 mm	02370L-7
9 mm	02370L-9



## Pneumatic tyre filler

calibrated version according to guideline 86/217/EWG.

- rubber-sheathed gauge
- with flexible 400 mm hose
- measuring / filling range 0 - 10 bar



CE YYY



### Product property

calibrated

### Max. operating pressure

10 bar

### Part no.

25032L

## Pneumatic tyre filler

European make, calibrated version.

- measuring / filling range 0 - 10 bar
- gauge rubber-sheathed
- length of filling hose ca. 540 mm
- scale diameter 56 mm (visible)



CE YYY

### Product property

calibrated

### Max. operating pressure

10 bar

### Part no.

25034L

## Pneumatic tyre filler

With large digital display for simple and comfortable read-off

- for operation with 2 x 1.5 V batteries (AAA)
- measuring accuracy +/- 1%
- 0 - 11 bar measuring range
- display accuracy 0.05 bar
- automatic switch off after 3 minutes



CE YYY

### Product property

non calibrated

### Max. operating pressure

12 bar

### Part no.

25033L

## Pneumatic tyre filler

- made of high-grade diecast aluminum
- with flexible hose 300 mm
- gauge 270° (0 - 15 bar)



CE YYY

### Product property

non calibrated

### Max. operating pressure

12 bar

### Part no.

25030L

## Spare hose

tyre air pistol, suitable for 25030L, 25032L, 25034L



YYY

Description	Product quality	Length	Part no.
430 mm long, reinforced version	YYY	430 mm	25036L
530 mm long, reinforced version	YYY	530 mm	25037L
1000 mm long	YYY	1000 mm	25038L



## Filling nipple for tyre inflator



Wear part for compressed air tyre inflators 25030L, 25032L, 25034L and matching spare hoses

- Attached using a hose clip (not included)
- Brass, 6 mm



Outer diameter  
6 mm

Part no.  
25031L

## Tyre air pressure tester



made of plastic



Description  
0,5 - 5,5 bar

Part no.  
72330L

## Tyre air pressure tester



digital, measurements can be displayed in bar, psi, kPA, kg/cm<sup>2</sup>  
• Tolerance +/- 1psi / 0,07 bar



Description  
0,15 - 9,50 bar

Product property  
non calibrated

Part no.  
72335L

## Tyre pressure sensor tool set



For TPMS, for mounting and disassembling tire pressure control systems.

Includes:

- torque 6.3 mm (1/4 ") 2-10 Nm, pitch 0.5 Nm, fine scale 0.1 Nm for fastening the metal valve to the rim
- torque screwdriver 1.4 Nm with 4 mm hex socket for mounting the RDC sensor on the valve
- valve sealing tool for damage-free mounting and dismantling of rubber seals on TPMS valves
- torque-limited valve actuator 0,25 Nm
- torque-limited valve driver 0.45 Nm
- pin punch
- long plug socket 11 mm
- long plug socket 12 mm
- screwdriver inserts T10, T15, T20
- screwdriving bit T10, T15, T20



ⓘ Since November 1st 2012, all new homologated vehicle model have been equipped with a tyre pressure system (TPMS). Since 1st of november 2014 this system applies for every new car.

Description  
15-piece

Part no.  
02129L

## Tyre pressure sensor tool set



Comprising:

- special torque screwdriver 1 - 5 Nm
- extra-long bit holders 11 + 12 mm for
- damage-free fitting of the union nut on the
- tyre valve
- screwdriver bit TX 20 for mounting
- self-locking TX attachment screw
- adapter 6,3 mm (1/4") for holding a T20 bit in case the installation space is not large enough for the use of the screwdriver insert

for installation and maintenance of the system it is important to meet the torque and manufacturers instructions! (standard torque: 4 Nm)



Description	Torque	Part no.
4-piece	1 - 5 Nm	02120L

## Tyre valve removal tool

for pulling out rubber tyre valves. This tool allows to install and remove gaskets of TPMS valves, as no sharp blades or edges are used.

ⓘ Only suitable for 11 mm valves!



Length	Part no.
139 mm	02118L

## Valve tool set

for fitting and removing valve inserts



Description	Length	Part no.
2-piece	140 mm	02110L

## Valve inserting tool set

with torque limitation.

This ensures a reliable fit and prevents sensitive valves being overwound

- inserting tool with 0.25 Nm for rubber valves
- inserting tool with 0.45 Nm for metal valves

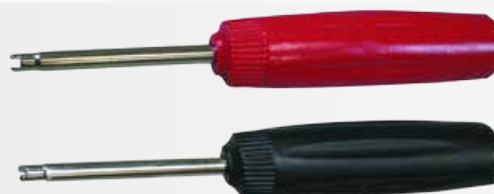

Description	Part no.
2-piece	02000L

## Valve inserting tool

with torque limitation.

This ensures a reliable fit and prevents sensitive valves from being overwound



Description	Torque	Part no.
For rubber valves	0,25 Nm	02025L
For metal valves	0,45 Nm	02045L





## Valve lathe tool for steel valves

Eases the installation and removal of steel valves, e.g. on alloy wheels, rims on transporters and mobile homes  
(The manufacturers recommend the use of steel valves to prevent pressure loss here)

- With guide pins - prevents slipping off
- Tightening feasible with torque wrench



Drive



Part no.

02112L

## Valve mounting pliers

for rubber snap-in valves with a diameter of 11.3 mm.  
For the simple and safe insertion of snap-in valves in steel and aluminium rims on passenger cars and transporters.

To prevent damage on the valve, insertion force, insertion angle and lubrication specifications must be met.

The innovative pliers design makes safe gripping of valves with valve caps made of hard or soft plastic possible.

The valve caps do not have to be removed! The stepped plastic support guarantees an optimum grip and best possible leverage on a wide range of rims. The variably mounted pliers head is kept open by springs and guarantees an optimum insertion angle in the axis of the valve bore. This minimises the force required and safely prevents damage to the valves.

- fitting faults are minimised and long-term damage avoided.
- suitable for valves with hard and soft plastic caps
- complete fitting without removing the valve cap
- no slipping thanks to safe support on the rim
- little force required through optimum leverage and perfect insertion angle
- tried-and-tested thousands of times in series production
- avoids complaints / cost claims (flat tyre damage) caused by inserting damaged valves
- quality tool made in Germany
- 5 year guarantee

⚠ **There is a much greater strain on rubber snap-in valves on transporters and mobile homes due to the higher tyre pressure. This makes correct fitting using a suitable tool all the more important.**



Description

For fitting valves with protecting case

Part no.

41445L

## Tyre valve stem fitting tool

for fitting valves in the rim valve hole on tubeless tyres.

The tool is equipped with a two-component support to better protect the aluminium and steel rims from damage while working.

Material: S45C, chrome plated



Length

300 mm

Part no.

02117L

## Tyre valve stem fitting tool



for fitting new valves in the rim valve hole on tubeless tyres.  
Suitable for all rims, with extra-wide support to protect the edge of the rim from damage.



**Length**  
310 mm

**Part no.**  
02115L

## Tyre valve stem fitting tool



for fitting new valves in the rim valve hole on tubeless tyres.



① Especially suitable for aluminium rims!

**Length**  
300 mm

**Part no.**  
02116L

## Tyre profile depth gauge



Digital

- measuring range from 0.00 to 28 mm
- display can be switched from metric / inches
- including battery LR44 digital



**Description**  
0 - 28 mm

**Part no.**  
72315SB

## Tread depth gauge



for precise determination of the tread depth for trucks, passenger cars and motorbikes.

- sturdy brass version
- 50 mm measuring depth
- scale marking 1/10 mm
- made in Germany



**Part no.**  
72311L

## Tread depth gauge



1/10 mm scale



**Description**  
0 - 30 mm

**Material**  
Brass

**Part no.**  
72310L

## Universal balance weight pliers



- for loosening weights on rims
- chromed
- length 245 mm
- handles isolated



**Length**  
245 mm

**Part no.**  
41440L





## Balancing weight pliers



The adhesive weight tongs are a release forceps for glued balancing weights.

- includes an integrated spring
- prevents the scratching of the aluminium rims during peeling



Part no.  
41442L

## Adhesive weights



for balancing aluminium rims.

- made of steel
- self-adhesive
- 60 g bars with 12 weights à 5 g which can be separated off
- 50 bars
- Size (5g) 19.2 x 11.6 x 4 mm

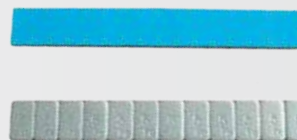

ⓘ With anti-corrosion coating!

Part no.  
41441L

## Glued weight remover



professional version

- almost indestructible
- solvent-resistant
- can be reground by means of file
- surfaces are not damaged



Description	Length	Part no.
22 mm blade width	275 mm	94850L

## Plastic scraper set



ideal for removing glued weights from aluminium car or motorbike wheels, or for loosening protective strips glued to the bodywork

- almost indestructible
- solvent-resistant
- can be reground by means of file
- surfaces are not damaged



Description	Length	Part no.
4-piece, 19-22-25-38 mm blade width	275 mm	94855L

## Stripe off wheel



for clamping in the drill.

- ideal for the residue-free removal of old adhesive resulting from the removal of glued weights.
- can also be used to remove residual paint and stickers from painted surfaces.
- 6 mm adapter with 5/16" x 24 threaded body
- wheel circumference: 90 x 15 mm
- speed: max. 4,000 rpm



Description	Part no.
Stripe of wheel with adapter	94857L
Stripe of wheel with M8 thread	94858L





## Tyre iron



with replaceable protection, for damage-free tyre fitting on aluminium rims

- the plastic top cover is fastened on the steel core by using 3 screws



Description	Length	Part no.
Complete	380 mm	02158L
Replacement plastic protection	360 mm	02159L
Complete	500 mm	02154L
Replacement plastic protection	500 mm	02157L

## Tyre iron



- chrome-vanadium
- heavy-duty version for commercial vehicles agricultural and construction machinery
- length 650 mm



Length	Part no.
650 mm	02161L

## Tyre iron



- chrome-vanadium
- heavy-duty version for commercial vehicles agricultural and construction machinery
- length 1000 mm



⚠ Only for wheel service - not to be used as chisel!

Length	Part no.
1000 mm	02163L

## Fitting paste



for the fast, gentle and easy fitting and removal of all standard wheel/tyre combinations including run-flat tyres.

- chemically neutral to rubber and metal
- the high sliding effect during fitting and removal reduces fitting injuries
- promotes the interlocking between rim and tyre
- 100% biologically degradable
- 100% guarantee of no contact allergies for fitters
- antifreeze-safe, processing temperature from -15°C to +50°C
- very efficient
- centrifuge-resistant
- color white



Description	Part no.
3 kg Bucket (Run-Flat and PAX)	02130L
5 kg Bucket (Run-Flat and PAX)	02132L

## Brush



with round head for better application of assembly paste.



Length	Part no.
330 mm	02135L



## Non-recoil hammer



without recoil, completely rubberised

- made of polyurethane glass fibre
- the hammer does not recoil thanks to steel balls in the hammer head
- especially for use during tyre changing for loosening rims that have become rusted tight



Head diameter	Length	Weight	Part no.
60 mm	375 mm	1,2 kg	51112L

## Non-recoil hammer



non-recoil, completely rubberised

- made of polyurethane glass fibre
- the steel balls in the hammer head prevent the hammer recoiling
- especially for use during tyre changing, for loosening rims that have become rusted tight



Head diameter	Length	Weight	Part no.
70 mm	500 mm	2,1 kg	51113L
105 mm	1050 mm	5,25 kg	51115L

## Tyre bag



Tyre bags on a roll, plastic (HDPE)

- 100 units per roll
- suitable for tyre sizes up to 19"
- Bag size: 700 x 300 x 970 mm



Part no.  
02136L

## Pressure Sprayer



- suitable for working overhead
- capacity: 1l
- suitable for brake cleaner, fuel and commercial cleaning agents
- including adjustable spray nozzle
- made of high-grade plastic



Part no.  
07384L

ⓘ Suitable for working overhead!





## Glass fibre reinforced wheel hub cleaner



Made of glass fibre reinforced polyamide-plastic (PA6), the main features of the hub grinder are as follows:

- extremely high tensile strength
- extremely high impact resistance
- extremely high abrasion resistance
- extremely low in weight

Its 12,5 mm (1/2") square drive fit allows it to be used with an impact wrench.

Areas of application and benefits:

- cleaning of wheel hubs and other flat surfaces Removes corrosion on the contact surfaces between the wheel hub and rim
- this gives you authentic wheel-tightening torques
- sturdy Velcro fastener for quick change of grinding wheels
- reduced weight with the use of high-quality plastic

Suitable for car wheel hubs with a diameter up to 150 mm.



ⓘ **Maximum drive: 1500 rpm!**

Part no.  
**10262L**

## Wheel hub grinder replacement cleaning discs



for wheel hub grinder 10262L

Corrosion between the rim and the wheel hub is removed and torque values can no longer be distorted.

- inner diameter: 90 mm
- outer diameter: 150 mm

Suitable for the latest wheel hubs with enlarged inner diameter of 75 mm, e.g.: BMW 1 (E81, E82, E87, E88, F20, F21) / 3er (E90, E91, E92, E93, F30, F31) / 5 and 5 GT (E60, E61, F07, F10, F11, F18) / 7 (E65, E66, E67, E68, F01, F02, F03, F04) / X1 (E84) / X3 (E83, F25) / X5 (E53, E70) / X6 (E71) etc.



### Description

Replacement cleaning disc, 2-piece  
15 x 7 cm, Height 1.5 cm

### Part no.

**10262L-1**

## Wheel hub cleaner set



For wheel hubs with stud bolts e.g. Ford, Porsche, Volvo, etc.

Content:

- 5 pieces of grinding wheel  $\varnothing$  40 mm
- 2 pieces replacement velcro strip
- With 8 mm hex drive, for stud bolts up to  $\varnothing$  14 mm
- 1/2" socket adapter for alternative drive



### Description

9-piece

### Part no.

**10259L**

## Wheel hub grinder replacement cleaning discs



for 10259L



Description	D	Part no.
6-piece	40 mm	10259L-2

## Truck wheel transporting device



facilitates the transport of truck wheels.

- Max. wheel weight 68 kg



Part no.  
20735L

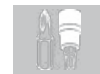

# BRAKES





# BRAKES

524-553



- ▶ ABS-Sensor tools 526-527
- ▶ Disc Brake Tools 527-539
- ▶ Drum Brake Tools 540-542
- ▶ Brake Fluid Tools 542-547
- ▶ Brake Pipe Tools 547-549
- ▶ Other Tools for Braking 550-552





## Universal reamer set for ABS sensors

The reamer set is made up of an exclusively clockwise-action, fine-toothed ratchet with quick-action change function and 5 reamers. The enclosed drill is used for drilling out corroded and thus stiff sensors.

When faults ABS sensors are replaced, residue from broken-off sensors often remains in the hole and is difficult to remove.

For the new sensors to be fitted correctly, the sensor seats in the wheel bearing housing must be cleaned using the respective reamers.

Scope of delivery:

- 10 x 150 mm VW Golf 5, Polo 9N, T5, Škoda Fabia, Seat Ibiza, Opel Insignia
- 15 x 23 mm Mercedes-Benz A-Class, Mazda, Ford
- 14 x 32 mm BMW E38, E39, E52, E60, E61, E63, E64, E65, E66, E70, E71
- 18 x 23 mm Audi, VW, BMW E36, E46, Seat, Škoda
- 18 x 34 mm Audi, VW, Seat, Škoda, commercial vehicles
- 10 x 133 mm twist drill for drilling out corroded sensors
- Jointed ratchet, clockwise-action only



**YYY**  
Audi  
BMW  
Ford  
Mazda  
Škoda  
Opel  
Mercedes-Benz  
Seat



**!** Jointed ratchet, clockwise-action only!

Part no.  
**10158L**

## Reamer

for cleaning the guide bore hole in the wheel bearing housing. The new ABS sensor can thus be fitted professionally and damage due to unprofessional insertion is avoided. The measured values are determined precisely through the exact fit. 10 mm x 150 mm long, drive 10 mm



**!** ABS-Sensor

**6.3** **YYY**  
VW  
Škoda  
Seat  
Opel

Description	Size	Length	Part no.
VW Golf 5, Polo 9N, T5, Škoda Fabia, Seat Ibiza, Opel Insignia	10 mm	150 mm	<b>10154L</b>

## Reamer

for cleaning the guide bore hole in the wheel bearing housing. The new ABS sensor can thus be fitted professionally and damage due to unprofessional insertion is avoided. The measured values are determined precisely through the exact fit.

14 mm x 42 mm long, hexagon drive 11 mm

**The product is especially interesting because it can be used with standard ratchet spanners such as S1596-11**



**!** ABS-Sensor tools

**YYY**  
BMW

Description	Size	Length	Part no.
BMW E38, E39, E52, E60, E61, E63, E64, E65, E66, E70, E71	14 mm	42 mm	<b>10153L</b>
Mercedes-Benz A-Class, Mazda and Ford	15 mm	33 mm	<b>10155L</b>
VW, Audi, Seat, Škoda, BMW E36 + E46	18 mm	35 mm	<b>10156L</b>
VW, Audi, Seat, Škoda and NFZ	18 mm	46 mm	<b>10157L</b>

## Combination ratchet wrench, Extra short

72 CrV YYY

Extra-short, chrome-vanadium, matt chrome-plated, finely toothed with 72 teeth, Can be switched right / left



Size	Length	Height	Part no.
11 mm	103 mm	12 mm	S1596-11
13 mm	108 mm	13 mm	S1596-13

## Disc Brake Tools

### Digital brake disc caliper

CE YYY

Extra long and narrow design makes it possible to measure the brake disc even when the wheels are mounted.

- measuring range from 0 - 80 mm to 0 - 3.2"
- depth of the external measuring tongs 28 mm / 1.10"
- resolution 0,01 mm / 0,0005"
- accuracy  $\pm 0,025$  mm /  $\pm 0,001$ "
- LCD display
- stable, hardened stainless steel
- automatic shutdown
- incl. 3 Volt CR2032 battery



Description	Part no.
	72347L
Replacement battery	72350L-Batt

### Brake disc gauge

servicing specifications state that the thickness of the brake discs is decisive as to whether they have to be replaced or not.

In addition, discs of different thicknesses have been fitted in some vehicles e.g. VW Lupo within one model series.

This means that the thickness has to be measured to establish whether or not the correct disc is fitted



Description	Part no.
Measuring range 0 - 60 mm	72345L

### Brake gauge

suitable for brake discs and drums from 160 to 360 mm in diameter



Description	Part no.
Measuring range 160 - 360 mm	72340L





## Flexible magnetic base holder

flexible, for gauge or other measuring instruments

- Thanks to the prism base which can be switched on and off, the bracket holds perfectly to struts, which are not made of alloy material
- For versatile adjustment including precision setting
- Ideal for testing the brake discs and wheel hubs for axial run-out



ⓘ Can be used with 26067L precision gauge!

Description	Part no.
Holder	07354L
Gauge	26067L

## Professional manual impact wrench set



profi version, with protective handle, high-alloy plain and cross slot bits in long and short version, especially for extremely tight screws e.g. on generator, brake callipers etc. 12.5 mm (1/2") drive, also suitable for plug-type bits, can be switched right/left.

Can be used for bits with 8 mm drive, extra-strong, impact-absorbing handle, high-strength bits made of hardened special steel.

- cross slot PH2 and PH3, 36 mm long
- plain slot 8 and 10 mm, 36 mm long
- cross slot PH2 and plain slot 8 mm, 80 mm long



Description	Part no.
8-piece	04130L

## Hand-held impact wrench set



with oversize inner hex bits for worn screws, high-strength version. The tools are made with a slight oversize and are tapered. This means the bits can be struck into the screw head by means of a hammer and then loosened with a spanner or even better with the hand-held impact wrench included.



ⓘ Ideal for brake discs, brake callipers, starters, belt pulley etc.

Description	Profile	Size	Part no.
12-piece			05040L
		T 40	05233L
Oversize bit		5,1 mm	05035L
Oversize bit		6,1 mm	05036L
Oversize bit		7,1 mm	05037L
Oversize bit		8,1 mm	05038L

## Pin punch

with extra-long mandrel, especially for brake pins



Description	Size	Length	Part no.
auf 3 mm recessed tip	6 mm	175 mm	09030L
Special length for brake pins	4 mm	175 mm	09040L



## Moulded insert



for equipping workshop cart"compact"  
In rigid petrol and solvent-resistant moulded insert

- brake line spanner
- special brake calliper brush
- pin punch
- brake disc gauge
- mole wrench
- special brake calliper file



① 2/3 insert

Description	Length	Width	Height	Part no.
9-piece	333 mm	330 mm	35 mm	Z2566-4

## Brake tool set



universal

- 1 brake calliper brush
- 1 brake calliper file
- 1 special punch for hollow pins
- 1 special punch for brake pins
- 1 patented mole wrench for loosening



Description	Part no.
5-piece	09050SB

## Special brake calliper brush set



with hook hole and ergonomically shaped handles,  
steel and brass



Description	Part no.
2-piece	09320SB
Steel wire brush	09321L
Brass brush	09322L

## Special brake calliper brush



made of steel wire, with hook hole.  
In the case of stubborn soiling, please use our brake calliper file 94830L



Description	Length	Part no.
Edge size 90 x 22 mm	230 mm	09300L





## Special brake calliper brush



made of brass, with hook hole.

Always required on all aluminium brake callipers to remove brake dust. Also suitable for cleaning work on all sensitive, metallic surfaces.



Description	Length	Part no.
Edge size 90 x 22 mm	230 mm	09310L

## Special brake calliper brush



made of steel wire, with hook hole.

In the case of stubborn soiling, please use our brake calliper file 94830L



Length	Part no.
260 mm	94830L

## Special socket, Square



for SAF and Knorr callipers



Description	Part no.
8 mm Square socket	37001L

## Special socket, Spline



for SAF and Knorr callipers



Description	Part no.
XZN tripe square M9 and hexagon SW12	37002L

## Brake calliper special bit



double pentagon, 12,5 mm (1/2") drive  
For loosening and tightening the lateral guide pins in the brake caliper. For example at vehicles with ceramic brake.

- Suitable for:
- Audi A6, A7, A8, Q7, RS6, RS7
  - Porsche Cayenne
  - VW Touareg



Audi  
Porsche  
VW

Part no.	37003L
----------	--------

## Brake calliper special bit



double pentagon, 12,5 mm (1/2") drive

For loosening and tightening the screwed connection of the brake caliper to the brake caliper bracket.

- Suitable for:
- Audi A6, A7, A8, Q7, RS6, RS7



Audi

Part no.	37004L
----------	--------

## IMPACT screwdriver bit, Spline, Short



12.5 mm (1/2") drive, XZN tripe square.

For fixing high-strength screws to brake carrier attachments at the rear as well as for screwing shock absorbers in place at the front on VW Passat 3C



VW  
Audi  
Seat



Profile	Size	Length	Part no.
○	M 14	40 mm	10195L-14K

## Brake calliper special key, Hexagonal socket



Lever 7 mm.



### Description

Lever 7 mm

12,5 mm (1/2") drive - 7 x 140 mm

### Part no.

04770L

04900L-INB7

## Special socket, Hexagonal socket



7 mm internal hex with 10 mm (3/8") drive.  
To release and fasten the rear calliper bolts on the BMW 3, 5 and 8 series model and on Opel models.



BMW  
Opel

### Part no.

S1850-1

## IMPACT socket, Double hexagon



for brake discs on SAF axles



### Description

for brake discs on SAF Achsen

### Profile



### Size

13 mm

### Part no.

01444L

## Special insert, Hexagonal socket



for calliper bolts and guide bolts



Mercedes-Benz

### Description

7 x 24 mm for Mercedes-Benz W204 (C-Class)

8 x 24 mm for Audi A4/A6/A8/TT

9 x 60 Mercedes-Benz W164/W251 (M-/R-Class), VW T5, BMW

### Drive



### Part no.

01411L

01412L

01413L

## Screwdriver bit, Hexagonal socket, Long



Chrome-vanadium.

Suitable for Mercedes-Benz ML brake callipers.

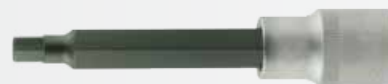

### Description

For plastic inserts on the injection valves of VAG petrol engines

For fuel cooling unit when changing the fuel filter VAG

### Profile



### Size

11 mm

13 mm

### Length

140 mm

140 mm

### Part no.

05018L

05019L



## Brake callipers, special sockets, Pentagonal



12,5 mm (1/2") drive, chrome-vanadium, for working on brake callipers

Smart  
Renault  
Peugeot  
Opel  
Citroën

- 1x screwdriver bit set, pentagon head 10 x 56 mm
- 1x socket spanner, pentagon head 14 x 38 mm
- 1x socket spanner, pentagon head 19 x 38 mm



Part no.  
**01448L**

## IMPACT socket, Pentagonal



for fitting and removing of brake callipers on Opel and Smart vehicles

Opel  
Smart



Profile	Size	Length	Part no.
○	14 mm	70 mm	<b>01438L</b>

## IMPACT socket, E Profile



for fitting wheel flange screws M18 x 1.5 as well as for changing brake discs on trucks



① **M2000, D08**

Description	Profile	Size	Length	Part no.
for fitting wheel flange screws M18 x 1.5 as well for changing brake discs on trucks	★	24 mm	110 mm	<b>38000L</b>
for Cylinder head screws MAN, new TGA engines	★	22 mm	110 mm	<b>38001L</b>
for Cylinder head screws MAN M2000, buses with engine types D08	★	18 mm	110 mm	<b>38003L</b>

## IMPACT socket



Special sockets for T-profile screws, suitable for use with impact wrench, 20 mm (3/4") drive, especially for steering column stalks and brake callipers for the Mercedes-Benz Actros

Mercedes-Benz LKW

High-strength version for extreme loads



Size	Length	Part no.
T60	130 mm	<b>05370L</b>
T60	80 mm	<b>05390L</b>

## IMPACT brake calliper socket, Hexagonal socket



in special length for mounting the brake calliper screws on the rear axle of Mercedes-Benz Actros and Citaro models with axle types HL7 + HL8 Hypoid, Neoplan ZF as well as MAN TGA wheel hubs

Mercedes-Benz LKW  
MAN LKW



Profile	Size	Length	Part no.
○	14 mm	138 mm	<b>01441L</b>

## Brake calliper spanner, Double hexagon

for mounting the attachment screws on the front braking system of Mercedes-Benz Atego and Actros vehicles



Mercedes-Benz LKW



Profile	Size	Part no.
	24 mm	01437L

## Guide bolt repair set

for the repair of faulty inner threads for brake guide bolts in wheel bearing housings / brake calliper carriers. The existing thread is widened to M10 x 1.25 and the guide bolts provided are screwed into place.



Audi  
Ford  
Opel  
Seat  
Škoda  
VW

inc. 10 replacement guide bolts

Description	Size	Length	Part no.
Complete set - 12-piece			01477L
Spiral drill	8,80 mm	125 mm	KOB-8,80
Thread tap M10 x 8 x 1,25			01477L-1
Replacement bolt M10 x 1,25 - 53 mm long			01477L-2

## Spare guide pin

as additions to the guide pin repair set 01477L

- Pin diameter: 12 mm
- Length without thread 54 mm
- Total length: 65 mm

e.g. used in

- VW Sharan, Touareg, Phaeton
- Transporter Synchro, Transporter '99-'10
- Seat Alhambra
- Audi A6, A8 (also Quattro)

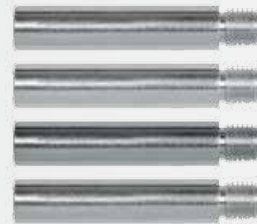

Audi  
Seat  
VW

Description	Part no.
Replacement bolt M10 x 1,25 - 65 mm long 4-piece Set	01478L
Replacement bolt M10 x 1,25 - 65 mm long	01477L-3

## Brake calliper tool set

for repairing brake callipers with integrated hand brake



Audi  
VW  
Ford  
Peugeot  
Seat  
Škoda

Description	Part no.
3-piece	01470L
Clamping / retaining nut	01471L
Brass drive-in mandrel	01472L
Special pliers	41420L



## Universal brake piston press tool



for brake pistons without rotating device



- for large passenger vehicles, e.g. Mercedes-Benz S Class, BMW 7, Porsche, lightweight trucks, off-road vehicles
- drive with width A/F 21 or 12.5 mm (1/2") square possible standard version



### Description

Clamping range 10 - 65 mm

### Part no.

01433L

## Universal brake piston press tool



for brake pistons without rotating device

- for large passenger vehicles, e.g. Mercedes-Benz S Class, BMW 7, Porsche, lightweight trucks, off-road vehicles
- clamping width 96 mm
- printing plates 110 x 60 mm



BMW  
Mercedes-Benz  
Porsche  
Land Rover  
Toyota

### Description

Span width 96 mm

### Part no.

01434L

## Universal brake piston press tool



universal, for brake pistons without a rotating device  
For quick, single handed operation:

- ideal for 1, 2, 4 and 8-piston brake systems
- rotatable by 360°



### Description

Clamping range 18 - 75 mm

### Part no.

01463L

## Universal brake piston press tool



universal, for brake pistons without a rotating device  
For quick, single handed operation:

- ideal for 1 and 2-piston brake systems
- rotatable by 360°



### Description

Clamping range 18 - 89 mm

### Part no.

01464L

## Universal brake caliper piston windback cube



Can be used for winding back most brake caliper pistons on systems that have hand-brake calipers.



### Part no.

01436L

## Universal brake caliper piston windback tool kit

Thanks to the universally adjustable adapter, the tool fits almost any vehicle that has brake calipers on the rear axle braking system.

- With two variably adjustable adapters for 2 and 3 holes on the brake piston
- With pressure spindle for left and right rotating brake pistons and 10 mm (3/8 ") mount , supplied in moulded hard plastic case



**Description**  
6-piece

**Part no.**  
**01466L**

## Universal brake piston rewinding tool

suitable for almost all brake callipers with right-handed winding brake pistons



**Description**

13-piece - with right-handed spindle

**Part no.**  
**01435L**

## Spindle

for brake piston rewinding tools.



① Suitable as addition to 01465L

**Description**

Right-handed spindle for 01435L + 01445L + 01465L + 01467L  
Left-handed spindle for 01435L + 01445L + 01465L + 01467L

**Part no.**  
**01435L-1**  
**01435L-3**

## Brake piston rewinding tool supplement

for upgrading the 13-piece brake piston rewinding tool to the latest version with left-handed spindle for e.g. Ford Mondeo, Opel Vivaro, Citroën etc. as well as the current, new press adapters



① Suitable as addition to 01465L

**Description**

5-piece  
Left-handed spindle for 01435L + 01445L + 01465L + 01467L  
Adapter plate 5 for 01432L + 01445L  
Adapter plate 6 for 01432L + 01445L e.g. Nissan Primavera, VW Golf IV, T4 / T5, Fiat Bravo (198) from 2007!  
Adapter plate E for 01432L + 01445L e.g. Nissan  
Adapter plate K for 01432L + 01445L

**Part no.**  
**01432L**  
**01435L-3**  
**01435L-5**  
**01435L-6**  
**01435L-E**  
**01435L-K**





## Universal brake caliper piston windback tool



Suitable for all common brake calipers

Contains:

- one right-handed and one left-handed spindle
- 15 different adapter plates
- 1 pressure pad



Description	Part no.
18-piece Complete set	<b>01445L</b>
Empty case	<b>01445L-KOFFER</b>

## Universal brake caliper piston windback tool



- brake piston rewinding tool for the simultaneous winding and pressing of brake pistons for almost all passenger cars
- 16-piece universal set
- for right and left-handed winding brake pistons
- with pneumatic spindle



Description	Part no.
brake piston set with pneumatic spindle	<b>01465L</b>
Empty case	<b>01465L-KOFFER</b>



## Adapter

for upgrading the individual sets.



VW  
Renault  
Citroën



① Not suitable for electronic parking brakes!

Description	Part no.
Adapter plate 0 / H 017 (Citroën, Golf GTI, Renault)	01465L-0
Adapter plate 5 for 01432L + 01445L	01435L-5
Adapter plate 6 for 01432L + 01445Lz.B. Nissan Primavera, VW Golf IV, T4 / T5, Fiat Bravo (198) from 2007!	01435L-6
Adapter plate 2 / H012	01465L-2
Adapter plate 3 / H013	01465L-3
Adapter plate 4 / H016	01465L-4
Adapter plate 7 / H014	01465L-7
Adapter plate 8 / H019	01465L-8
Adapter plate 9 / H018	01465L-9
Adapter plate A / Z / HA	01465L-A
Adapter plate E for 01432L + 01445L e.g.. Nissan	01435L-E
Adapter plate F / G / HB	01431L
Adapter plate K for 01432L + 01445L	01435L-K
Adapter plate M, Ford	01465L-M
Adapter plate N / L with 12 mm hexagon	01465L-N
Pressure plate H010	01435L-2
Adapter plate A for 01467L	01467L-A
Adapter plate B for 01467L	01467L-B
Adapter plate C for 01467L	01467L-C
Adapter plate D for 01467L	01467L-D
Adapter plate E for 01467L	01467L-E
Adapter plate F for 01467Lz.B. for Peugeot 206 from '03	01467L-F
Adapter plate J for 01467L Alfa, Audi, Citroën, Fiat, Ford, Honda CRX, Jaguar, Lancia, Nissan, Peugeot 306, Renault Master, Rover, Safron, Seat, VW Passat, T4, Volvo S40, V40	01467L-J
Adapter plate K for 01467L e.g. for Citroën C5	01467L-K
Adapter plate K1 for 01467L	01467L-K1
Adapter plate K2 for 01467L	01467L-K2
Alfa, Fiat, Ford, Honda, Rover, Safron	01467L-Q
Adapter R (Ford, Mazda, Mitsubishi, Toyota)	01467L-R
Adapter S (Renault, Lancia, BMW, Audi)	01467L-S
Adapter T (Renault Modus)	01467L-T
Adapter V (Renault Clio)	01467L-V
Adapter P (Citroën C3)	01467L-P
Pressure plate 11 (Jaguar S-Type)	01467L-11
Pressure plate 12 (BMW-Mini)	01467L-12
Pressure plate OD (Citroën)	01467L-0D
Pressure plate G1 (VW Golf V + VI)	01467L-G1
Adapter plate (Ford Focus / C-Max / S-Max, Renault Scénic / Mégane / Iveco Daily / Volvo V70) Not for electric parking brake for VAG models	01467L-W



## Universal brake caliper piston rewinding tool



Innovative system for right and left-handed winding pistons. Additional tools such as pin punches, interchangeable retention plates and further adapters make universal use possible even where linings are extremely worn as well as the assembly of the brake caliper reset.

- one spindle each with right-hand thread and left-hand thread
- 3 special brake caliper pentagon sockets
- 2 Allen keys 6mm ,7 mm
- 2 pin punches for loosening the retaining pin on Mercedes-Benz and Vauxhall / Opel
- 3 interchangeable retaining plates, 2 of which are open for use with heavily worn brake pads / in cramped conditions
- including thread oil and application list



- Toyota
- Vauxhall
- Volvo
- VW
- Alfa Romeo
- Subaru
- Seat
- Safrom
- Rover
- Renault
- Proton
- Peugeot
- Nissan
- Audi
- BMW
- Citroën
- Fiat
- Jaguar
- Honda
- General Motors
- Ford
- Mitsubishi
- Mazda
- Lincoln
- Lancia
- Mercedes-Benz
- Opel

Description

43-piece

Part no.

01467L

## Spring loaded brake caliper piston windback tool

Spring loaded Brake caliper piston windback tool. This spring loaded pressure spindle is suitable for all brake systems with left or right rotating brake pistons. The pressure on the brake piston is mechanically applied by means of a spiral spring applied in the tool. The rotary movement is performed by hand manually.

This spindle can be easily combined with existing brake piston tools from SW-Stahl.



Part no.

01462L

## Universal brake caliper piston windback adapter plates

Universal brake Caliper piston adapter

Universal adapter kit for retracting brake pistons. The distances between the turning pins can be adjusted by means of simple but robust mechanics. One universal adapter for brake pistons with two or three pick-up points.

The adapters are suitable for left and right rotating spindles and fit perfectly on existing SW-Stahl brake piston turning tools. Supplied in hard plastic case.



Description

3-piece

Part no.

01461L

## Pneumatic spindle



for brake piston rewinding tools

- suitable both for right and left-handed winding brake pistons
- compensates different thread pitches in the piston through infinite spindle, making
- brake repairs significantly easier
- all adapters in our sets 01432L - 01435L - 01445L fit onto this spindle, making their use even more convenient and faster.
- different thread pitches are compensated automatically.
- pressure is exerted on the brake piston pneumatically, which means only minimum force is necessary.
- the winding movement is then easy to affect by hand.



① Useful addition for 01445L + 01467L

Description	Part no.
Pneumatic spindle	01455L

## Brake piston reset tool



- operated by hand or with 12 mm external hex



VW

① VW T5

Description	Part no.
	01449L

## Brake piston rewinding tool



for WABCO and Knorr disc brakes on truck axles from SAF and other manufacturers under cramped conditions. Time saved per wheel is around 15 minutes



Description	Part no.
Special Magnetic socket 8 + 10 mm + special spanner	37500L
Magnetic socket 8 mm with 12 mm hexagon drive	37000L-8
Magnetic socket 10 mm with 12 mm hexagon drive	37000L-10



## Brake drum tool set

- 1 set of brake spring pliers with movable claw and attached coatings
- 1 set of brake spring pliers to remove and replace the return spring, forged design
- 1 calliper brush, steel, specifically to remove brake abrasion from the callipers
- 1 calliper brush, steel, specifically to remove brake abrasion from aluminium callipers
- 1 braking spring assembly tool, to install and remove the brake carrier spring, specifically for VW, Seat, Škoda, Opel, Renault
- 1 calliper file, extra-slim design, specifically to remove brake abrasion, rust and dirt from the callipers
- 1 brake line wrench, offset at both ends, with retracted, reinforced hex sockets, size 10x11 mm
- 1 assembly hook to install and remove the tension spring, e.g. on Mercedes, VW LT from '97
- 1 brake spring installation tool to fit springs to the parking brake
- 1 set of brake cable spring pliers to install and remove the hand-brake cable
- 3 screwdriver bots, inner hex 6x110 mm, 7 x 110 mm, 8 x 80 mm
- 1 T-handle to fit the callipers and dismantle the hand brake cheek retainer spring, (cylindrical and conical) on Mercedes-Benz vehicles
- 1 universal socket BMW 3, 5 and 8 series, and Opel



### Description

15-piece

### Part no.

S1850

## Brake drum tool set

- 1 brake spring tensioner
- 1 brake spring pliers with movable claw
- 1 hose clamp
- 2 brake piston clips
- 1 hand brake cable pliers



### Description

6-piece

### Part no.

S1833

## Brake gauge

suitable for brake discs and drums from 160 to 360 mm in diameter



### Description

Measuring range 160 - 360 mm

### Part no.

72340L

## Brake spring pliers

with movable claw for riveted and glued pads



### Length

317 mm

### Part no.

40810L

## Brake spring pliers

For removing and installing the brake drum spring, for both glued and riveted linings



① Extra heavy duty

Length  
500 mm

Part no.  
40811L

## Brake spring pliers

for mounting the spring claws on drum brakes on the Mercedes-Benz A-Class, Citroën, Renault, Peugeot with Lucas drum brakes



Mercedes-Benz  
Citroën  
Peugeot  
Renault

① e.g. Mercedes A-Class drum brake

Length  
200 mm

Part no.  
40820L

## Brake spring pliers

for detaching and attaching the retraction spring



Length  
220 mm

Part no.  
40830L

## Spring plate pliers

Ideal for the quick and easy removal and assembly of the brake shoes from the drum brakes. Universal for all standard spring plates of 7 - 30 mm diameter. Due to the angled shape also suitable for hard-to-reach places. Length 180 mm.



Length  
180 mm

Part no.  
01476L

## Brake spring fitting tool

with aluminium handle, zinc-coated.  
For installing and removing the brake carrier spring



Part no.  
01475L

## Brake spring fitting tool

for Mercedes-Benz parking brakes

- overall length 140 mm



Mercedes-Benz

Part no.  
01406L





## Pipe wrench, Hexagonal



10 mm hex with 6.3 mm (1/4") drive

**BMW**  
Mercedes-Benz  
Audi

e.g. for:

- Bumper bolts on Mercedes-Benz and Audi A3 Sportback
- To set the hand brake on BMW E30, E32, E34



Size	Length	Part no.
10 mm	160 mm	04408L

## Brake cable spring pliers



for the simple removal and fitting of the hand brake cable to the brake shoes.



Length	Part no.
230 mm	40805L

# Brake Fluid Tools

## Brake fluid tester



electronic, for determining the water content in the brake fluid. Its compact design means it fits nicely into the service technician's overall pocket, the state of the brake fluid is determined quickly and shown in five stages (green - yellow - red).



- Green: battery OK, no water contained
- Green - yellow: < 1% water content
- Green - yellow - yellow: Approx. 2% water content
- Green - yellow - yellow - red: Approx. 3% water content Brake fluid replacement recommended
- Green - yellow - yellow - red - red: At least 4% water content

**DANGER!** The brake fluid must be replaced urgently!  
Delivery including 1 x 1.5V AAA battery

📌 **Improved version**



Part no.  
21555L

## Brake bleeder non-return valve



made of high-grade aluminium

- for the bleeding of braking and clutch systems without need of a second person
- the integrated non-return valve prevents the backflow of the evacuated air and brake fluid
- therefore no annoying closure required when pumping via the brake or clutch pedal (lever)
- simple application, between bleeder valve of the wheel brake cylinder and collecting tank
- open the valve carefully and press the break pedal multiple times to pump down air and brake fluid
- the old fluid can directly be pumped into the bottle and disposed eco-friendly

📌 **With check valve - easy to use by only one person!**



Part no.  
01429L

## Vacuum brake bleeder



specifically for motorcycles, with all parts including collecting container, brake nipple and connecting hose. The air/liquid is extracted from the system by pressing several times on the container. Two brake pistons can be bled at the same time thanks to the twin adapter.



Part no.  
**01426L**

## Brake bleeding device



for one-person operation, can be used for clutch and steering systems as well as for the fuel line during filter replacement.

- compressed air connection: 6 - 12 bar
- vacuum 60%
- capacity: 1 liter



Description	Length	Part no.
Brake bleeding device complete		<b>01420L</b>
Replacement rubber pipe		<b>01427L</b>
Flexible hose	1000 mm	<b>08493L</b>

## Brake bleeding device



for the safe evacuation of the brake fluid and simultaneous refilling without a second employee being necessary.

The device is operated by compressed air and generates a vacuum which enables it to be attached directly to the brake callipers/wheel-brake cylinder. The brake fluid is suctioned off and drained directly into the collecting tank. The collecting tank ensures automatic refilling at the surge tank without overspill, thus saving on the second employee.

- capacity of collecting tank 2 l
- capacity of filling set 1 l
- 1 m flexible hose with universal adapter for bleeding nipples
- additional hose with fine point for e.g. suction of the brake fluid
- very clean use due to draining valve on bottom of the tank
- floating valve for spilling protection in collecting tank
- incl. 6,3 mm (1/4") pneumatic plug nipple



Description	Part no.
2-piece - Complete set with Replacement filing tank	<b>01422L</b>

## Refill set



for brake bleeding device.

The collecting tank ensures automatic refilling at the surge tank without overspill, thus saving on the second employee.

- Capacity 1 l



Description	Part no.
Replacement filing tank	<b>01423L</b>





## Brake bleeding device

for the bleeding of brake and clutch systems.  
With 5 liter tank and collecting bottle for brake fluid at the bleeding nipple.

- a rubber membrane divides the compressed air and brake fluid and prevents intrusion of water
- optimum working pressure of 1.2 bar can be adjusted by pressure regulating valve on the device
- with relief valve and 3,5 m filling hose
- incl. refill adapter for all popular applications (Euro-adapter: Audi, BMW, VW, Opel, Ford)



Audi  
BMW  
Ford  
Opel  
VW

Part no.  
**01498L**

## Adapter set

for brake bleeding device 01498L  
with quick-action coupling, contains:

- Opel adapter Ø 34.5 mm
- Opel sealing cap Ø 42.5 mm, for sealing the second filling openings
- universal adapter Ø 45 mm
- universal tapered adapter incl. pressure pad, 2 screw hooks with knurled nuts and chain
- euro adapter suitable for Audi, BMW, VW, Opel, Ford
- Nissan Ø 49.5 mm
- Honda Ø 56 mm
- BMW, Audi Ø 44.2 mm

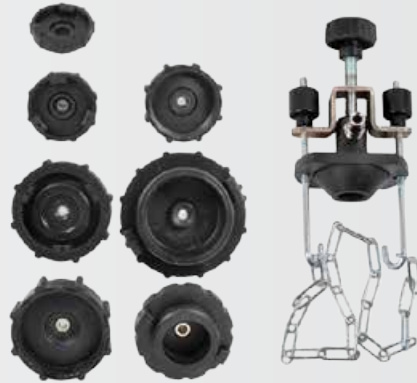

Audi  
BMW  
Ford  
Opel  
Nissan  
Honda  
VW

ⓘ Quick-action couplings are suitable for all popular brake bleeding devices

Part no.  
**01499L**

## Brake pedal retaining tool

is an ideal tool for the venting of hydraulic brake systems and for checking the braking force regulator.

The brake pedal can be fixed in position by supporting the retaining tool on the seat or on the steering wheel and adjusting the length accordingly until the pedal is in the desired position. A constant brake pressure is ensured through integrated suspension.



Part no.  
**01479L**

## Multi-purpose pump

for replenishing fluids e.g. brake fluid, oil, fuel and cleaning agent.  
With 500 mm hose and filling hook for places that are difficult to access.



ⓘ 1 liter

Part no.  
**24002L**



## Adapter for brake bleeding

for most european vehicles with filling hole of 46.5 mm. The rotatable angular connection allows the use even when there is less space at the surge tank

- 6.3 mm (1/4") pneumatic plug nipple

Suitable for:

e.g. Audi, BMW, VW, Opel, Mercedes, Mazda 3, Fiat, Ford Focus, Fiesta, from model year 2008, Galaxy from model year 2006, Kuga, S-Max, Volvo C30, S40, from model year 2004, V50, etc.

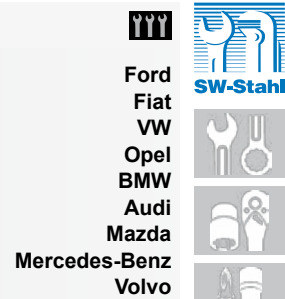

Description

Euro 20

Part no.

01497L

## Extraction pump

for manual or pneumatic operation with 9.5 l tank, ideal for bleeding brakes and for oil extraction, suitable for day-to-day workshop use

- permits clean oil changing thanks to extraction
- suitable for motor, gear and rear axle oils as well as other non-corrosive liquids
- suction hose diameter in 9.8 - 8.0 - 6.7 - 4.5 mm for extraction through the dipstick tube
- 9.5 l tank for the collection of large amounts of oil
- suitable for oil extraction on Smart and other vehicles where oil changing is to be carried out without the use of a lifting platform
- incl. special silicon brake bleeding hose with valve for one-handed operation
- makes the bleeding of brake systems easier on all vehicles
- the built-in manual vacuum pump enables brakes to be bled without a compressed air connection being necessary



Part no.

24035L

## Vacuum pump

for universal use, for building up pressure and vacuum. Complete with hose and various couplings in a case. Ideal for brake and clutch bleeder and to bleed the fuel system e.g. on (ISA) V6 TDI engines as well as for testing of:

- vacuum cells e.g. on air-conditioning systems
- turbochargers etc.
- vacuum - 0,8 bar
- pressure - 4 bar



Part no.

01424L



## Bleeder pump

Bleeder pump for passenger cars and motorbikes

- for the fast bleeding of brake systems on passenger cars and motorbikes without pneumatic insert
- can also be used for bleeding fuel filters on diesel and petrol engines

### Scope of delivery:

- manometer
- hand pump
- rubber sleeves
- adapter for all brake nipples
- two short hoses
- tank with cover

ⓘ **Vacuum until -0,8 bar**



Part no.  
**01425L**

## Mole wrench

PATENTED, for the powerful loosening of brake and bleeding nipples.

Wrench can be used up to jaw size 14 mm without any problem.

ⓘ **All profiles are gripped in three places and loosened powerfully**



Length  
100 mm

Part no.  
**41530L**

## Brake bleeding key set

Facilitates activating the bleed screws on the rear axles without removing the wheels. The open design of the key enables feeding through a silicon tube, e.g., in a bleeding pump.

- 1 special ratchet 150 mm with angled head, fine-toothed, reversible
- 1 bleed key SW11, 20 mm short (e.g. VW Passat, Audi A4)
- 1 bleed key SW11, 65 mm long (e.g. VW Golf V, Audi A3, Seat Altea, Škoda Octavia)



ⓘ **Ideal if only the brake fluid is changed**



Audi  
VW  
Škoda  
Seat

Description  
3-piece

Part no.  
**01421L**

## Brake line spanner, Hexagonal

Chrome-vanadium, chrome-plated



Description	Length	Heigth	Part no.
10 x 11 mm	153 mm	10 mm	<b>01400SB</b>
12 x 13 mm	168 mm	11 mm	<b>01401SB</b>
15 x 17 mm	190 mm	12 mm	<b>01402SB</b>

## Brake line spanner set, Hexagonal

Chrome-vanadium, chrome-plated

10 x 11 + 12 x 13 mm



Description  
2-piece

Part no.  
**01450SB**

## Brake line spanner, Hexagonal



Chrome-vanadium, chrome-plated

PROFI version with non-slip hexagonal end



Description	Length	Height	Part no.
10 x 11 mm	180 mm	15 mm	01405SB

## Brake line spanner, Hexagonal



Chrome-vanadium, with flexible joints, also ideal for screw attachment jobs on air-conditioning systems, hydraulic and brake lines, power steering etc.

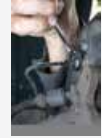

Description	Part no.
10 x 11 mm	01488L-2
12 x 13 mm	01488L-3

## Brake line spanner set, Hexagonal

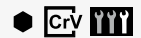

Brake pipe metric spanner set, hex. Open ring key set.

- 8 x 10 mm
- 9 x 11 mm
- 12 x 13 mm
- 14 x 15 mm
- 16 x 18 mm
- 17 x 19 mm



Description	Part no.
6-piece	01415L

## Brake line spanner, Hexagonal



open-ended ring spanner



Description	Part no.
8 x 10 mm	01415L-1
9 x 11 mm	01415L-2
12 x 13 mm	01415L-3
14 x 15 mm	01415L-4
16 x 18 mm	01415L-5
17 x 19 mm	01415L-6

# Brake Pipe Tools

## Mechanical flaring tool for SAE- and DIN-flaring



For flaring brake pipes with 4.75 mm (3/16") diameter for SAE- and DIN-flarings. The tool can be used especially for working under the vehicle.



Length	Part no.
0,21 m	24529L





## Hydraulic flaring tool

For quick and easy handling because of hydraulic pressure spindle. Suitable for direct work on the vehicle. Includes several sizes of tools and adapters for flaring of brake-, gear-, oil- and air condition lines.

- With hydraulic pressure spindle
- No breaking of lines during flaring
- Suitable for direct work on the vehicle
- Metric flaring in 4 mm, 6 mm, 8 mm und 10 mm
- 45° double flared lap in 3/16" (4.75 mm), 1/4", 5/16", 3/8" und 1/2"
- Flaring of GM fuel lines in 5/16" und 3/8"
- Flaring of pipe connections in 1/4", 5/16" und 3/8"



Part no.  
**24518L**

## Flaring tool

in plastic case, suitable for direct work on the vehicle

- spindle and pressure pads with quick coupling for easy replacement
- with oilhydraulic spindle for easy work
- magnetic clamping jaw seat
- for lines in steel, aluminium, copper, brass with 4,75 mm (3/16") - 5 mm - 6 mm (1/4")
- also for plastic sheathed brake lines
- suitable for convex and double flared lap for SAE and DIN
- pipe cutter included 3- 16 mm



① **Mobile Ausführung!**

Description  
Complete

Part no.  
**24535L**

## Flaring tool

Packed in plastic case, can be used in vice, TOP quality for fast and perfect work.

- suitable for inner and outer flaring
- aluminium, brass, copper and steel pipes
- coated and non-coated pipes
- incl. 4 pairs of pressure pads for the following dimensions:  
3/16" / 4.75 mm - 5 mm - 6 mm - 1/4"



Description  
Complete

Part no.  
**24520L**

Pressure pad 4,75 mm	<b>24520L-1</b>
Pressure pad 5,00 mm	<b>24520L-2</b>
Pressure pad 6,00 mm	<b>24520L-3</b>
Pressure pad 8,00 mm	<b>24520L-4</b>
Pressure pad 1/4"	<b>24520L-5</b>
Press bracket	<b>24520L-6</b>
Flaring pin 4,75 mm, OP1	<b>24520L-10</b>
Flaring pin 5,00 mm, OP1	<b>24520L-11</b>
Flaring pin 6,00 mm, OP1	<b>24520L-12</b>
Flaring pin 8,00 mm, OP1	<b>24520L-13</b>
Flaring pin 1/4", OP1	<b>24520L-14</b>
Flaring pin 1/4" + 4,75 mm, OP2	<b>24520L-15</b>
Flaring pin 5,00 + 6,00 mm, OP2	<b>24520L-16</b>
Flaring pin OP0	<b>24520L-17</b>

## Beading tool for brake lines

in box, enables beading work to be carried out at the vehicle. Suitable for lines with cross-sections of 4 - 4.75 - 6 - 8 - 10 - 12 - 14 mm, complete with pressure pieces and pipe cutters with deburring tool, suitable for passenger cars and small delivery trucks.



### Description

10-piece  
4,75 mm  
6,00 mm  
8,00 mm

### Part no.

**24510L**  
**24501L**  
**24503L**  
**24504L**

## Pipe cutter

for copper, brass and light alloy



### Description

3 - 22 mm = 1/8" - 7/8"

### Part no.

**24540L**

## Pipe cutter

for copper, brass and light alloy  
with deburring blade in the handle



### Description

3 - 28 mm = 1/8" - 1 1/8"

### Part no.

**24530L**

## Bending pliers

made of aluminium, e.g. for fuel and brake lines with 3.00 + 4.75 + 6.00 mm diameter (1/8" + 3/16" + 1/4"). Ideal for repair work directly at the vehicle.



### Length

190 mm

### Part no.

**24517L**

## Pipe bending pliers

universal, makes it possible to bend brake lines, thin steel pipes and copper pipes according to DIN EN 1057 by up to 90°



### Description

4 - 6 - 8 - 10 mm

### Part no.

**24516L**

## Bending pliers

for brake lines, steel-, copper- and aluminum pipes with 4.75 mm + 6.35 mm + 7.95 mm + 9.55 mm diameter. A deflection is possible up to 180°. The line cross-section is not affected.



### Length

275 mm

### Part no.

**24514L**





## Brake linkage slack adjuster pull-off tool, Hexagonal



for automatic linkage slack adjusters. Very sturdy welded design made of tempered hardened steel for pulling off stiff brake linkage set slack adjusters. Applications for truck trailers and semi-trailers. Thanks to the ring-shaped contact surface, the tool is suitable for both older and automatic brake linkage slack adjusters.

Excess load and injuries are excluded to a major extent through the safety shearing bushing. Reduces the risk of accident and goes easy on the material. Spindle and shearing bushing are available as spare parts.

- Drive size 32 hexagon, coated in gold colour



Description	Profile	Size	Part no.
Haldex system	●	32 mm	01442L

## Brake linkage slack adjuster pull-off tool, Hexagonal



for automatic linkage slack adjusters. Very sturdy welded design made of tempered hardened steel for pulling off stiff brake linkage set slack adjusters. Applications for truck trailers and semi-trailers. Thanks to the ring-shaped contact surface, the tool is suitable for both older and automatic brake linkage slack adjusters. Excess load and injuries are excluded to a major extent through the safety shearing bushing. Reduces the risk of accident and goes easy on the material. Spindle and shearing bushing are available as spare parts. Size 32 hexagon drive Coated silver coloured



Description	Profile	Size	Part no.
BPW system	●	32 mm	01443L

## Replacement spindle, Hexagonal



for brake linkage slack adjuster pull-off tool



Profile	Size	Part no.
●	32 mm	01446L

## Cylinder honing tool



for use in electric drills, with 28 mm honing segments.

No cuts in the cylinder thanks to adjustable pressure



- ① Complete with segments in normal grade

Description	Part no.
2-arms, for diameter 19 - 50 mm	41100L
3-arms, for diameter 32 - 90 mm	41101L
3-arms, for diameter 51 - 178 mm	41102L

## Honing segments



with attachment pin



Description	Part no.
for 41102L - Normal grade - 3 piece - 100x10 mm	41113L
for 41100L - Normal grade - 2 piece - 28x4 mm	41116L
for 41100L - Fine grade - 3 piece - 28x4 mm	41117L
for 41101L - Normal grade - 3 piece - 50x5 mm	41118L
for 41102L - Fine grade - 3 piece - 100x10 mm	41114L
for 41102L - Coarse grade - 3 piece - 100x10 mm	41115L
for 41101L - Fine grade - 3 piece - 50x5 mm	41119L

## Glass fibre reinforced wheel hub cleaner



Made of glass fibre reinforced polyamide-plastic (PA6), the main features of the hub grinder are as follows:

- extremely high tensile strength
- extremely high impact resistance
- extremely high abrasion resistance
- extremely low in weight

Its 12,5 mm (1/2") square drive fit allows it to be used with an impact wrench.

Areas of application and benefits:

- cleaning of wheel hubs and other flat surfaces Removes corrosion on the contact surfaces between the wheel hub and rim
- this gives you authentic wheel-tightening torques
- sturdy Velcro fastener for quick change of grinding wheels
- reduced weight with the use of high-quality plastic

Suitable for car wheel hubs with a diameter up to 150 mm.

ⓘ **Maximum drive: 1500 rpm!**



Part no.  
10262L

## Wheel hub grinder replacement cleaning discs



for wheel hub grinder 10262L

Corrosion between the rim and the wheel hub is removed and torque values can no longer be distorted.

- inner diameter: 90 mm
- outer diameter: 150 mm

Suitable for the latest wheel hubs with enlarged inner diameter of 75 mm, e.g.: BMW 1 (E81, E82, E87, E88, F20, F21) / 3er (E90, E91, E92, E93, F30, F31) / 5 and 5 GT (E60, E61, F07, F10, F11, F18) / 7 (E65, E66, E67, E68, F01, F02, F03, F04) / X1 (E84) / X3 (E83, F25) / X5 (E53, E70) / X6 (E71) etc.



Description	Part no.
Replacement cleaning disc, 2-piece 15 x 7 cm, height 1.5 cm	10262L-1





## Wheel hub cleaner set



For wheel hubs with stud bolts e.g. Ford, Porsche, Volvo, etc.

Content:

- 5 pieces of grinding wheel Ø 40 mm
- 2 pieces Replacement velcro strip
- With 8 mm hex drive, for stud bolts up to Ø 14 mm
- 1/2" socket adapter for alternative drive



Description  
9-piece

Part no.  
10259L

## Wheel hub grinder replacement cleaning discs



for 10259L

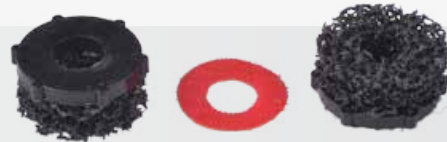

Description  
6-piece

D  
40 mm

Part no.  
10259L-2

## Digital infrared thermometer



With laser pointer, automatic shutdown, illuminated digital display, ideal for measurements on hot or rotating parts, liquids or spots that are difficult to reach.

- measuring range -50 to + 550°C
- measuring accuracy ± 2,5%
- operating temperature: 0° - 50°C
- distance factor 12 : 1
- switchable °F / °C
- incl. 2x AAA battery



Part no.  
72360L

## Pressure Sprayer



- suitable for working overhead
- capacity: 1l
- suitable for brake cleaner, fuel and commercial cleaning agents
- including adjustable spray nozzle
- made of high-grade plastic



ⓘ Suitable for working overhead!

Part no.  
07384L





# BODY





# BODY

# 554-603



▶ Diagnosis and Testing Units 556

▶ Car Glass Tools 556-563

▶ Windscreen Wiper / Cleaning 563-565

▶ Steering Wheel / Airbag 566

▶ Doors / Door Trim 566-582

▶ Body and Paint 582-589

▶ Metal Working 590-602



## Coating thickness gauge

for universal use for determining paint thickness on iron and NF metals, e.g. when detecting accident damage.

- digital display with lighting
- automatic switch-off
- one-hand operation
- measuring frame "Stärke": 0 bis 40 mils (0 bis 1000 µm)
- resolution: 0,1 mils/ 1 µm
- incl. bag and 2 measuring plates (iron/aluminium)
- reaction time: 1 sec

accuracy:

- +/- 4 dgts per 0 to 7,8 mils
- +/- 10 dgts per 0 to 199 µm
- +/- (3% + 4 dgts) per 7,9 mils to 40 mils
- +/- (3% + 10 dgts) per 200 µm to 1000 µm



ⓘ **Ideal for aluminium chassis! Not suitable for plastic bodies.**

Part no.  
**72375L**

## Body gap dimension gauge

For fitting work during the installation of e.g. wings, vehicle doors, tailgate, bonnet, vehicle windows etc.

The adjustable suction cup and the ball-bearing plastic gauge blades makes the device suitable for a flexible range of uses. The 10 setting gauges allow the gap to be set from 1 mm to 10.6 mm.



Description  
3-piece

Part no.  
**09106L**

## Car Glass Tools

### Windscreen stand

for windscreens and rear windows, side windows etc.

- 4 movable rubber suction cups with a diameter of 130 mm adapt to any window shape
- 55 kg load-bearing capacity
- powder-coated tubular steel frame
- can be folded away
- 1.150 mm long and max. 450 mm wide,



Description  
Windscreen stand  
Replacement rubber suction cap

Part no.  
**20335L**  
**20335L-1**

## SAUER Uni-Heat U3230



For a wide range of tasks on vehicle bodies. Ideal for removing adhesive labels, lettering, paint, decorative strips, and insulating mats. The special induction head included also allows removal of glued-in windscreens.

In addition to the basic unit, the scope of delivery also includes the following induction tools:

- Heating pad: For heating entire areas
- Heating rod: For the pinpoint heating of e.g. screws, nuts, tie rods, and exhaust pipes.
- Special head: For removing glued-in car windscreens

Product benefits:

- Pinpoint heating of components
- No open flames — no heating of/damage to surrounding components
- Particularly suitable for use in tight spaces
- Rapid and easy
- Saves time and increases productivity

Techn. data:

- Heat output: 3.0 kW
- Current consumption: 16 A
- Power supply: 230 V
- Induction cable: 2.2 m
- Weight: 12.5 kg



Description	Part no.
Uni-Heat U3230	70100300
Heating pad for U3230	70200301
Induction head for U3230	70200303
Induction rod for U3230	70200304
Replacement foot switch for U3230	70200305
Replacement glove for U3230	70200302

## Pneumatic glazing remover



inc. standard straight blade

- 57 mm long
- 20,000 rpm
- air consumption 113l/min.
- with 6,3 mm (1/4") pipe connection
- weight only ca. 1,150g



Description	Working pressure	Air consumption	Part no.
Complete unit	6,3 bar	113 l/min	40003L
1 straight replacement blade, 52 mm			400030L

## Cutting blade set



for pneumatic glazing remover 40003L or models of other manufacturers with the same blade seat

- straight and bent
- 18 - 36 - 63 - 90 mm long



Description	Part no.
7-piece	400035L





## Cutting blade



for pneumatic glazing remover 40003L

- straight
- 57 mm long



### Description

### Part no.

1 straight replacement blade, 52 mm  
7-piece

**400030L**  
**400035L**

## Cutting blade set



high-quality, semi-circular special blades for removing glazing from car windows, fits almost all pneumatic and electric machines



### Description

### Part no.

2 Bent replacement blade, 24 mm  
2 Bent replacement blade, 36 mm

**400024L**  
**400036L**

## Glazing-removal tool set



for the glazing-removal of bonded front and rear panes without a second employee.

- suction lift with return spring and receptacle for quick coupling
- adapter with quick coupling for cutting wire
- quick coupling for cutting wire

The suction lift adapts automatically to the cutting direction of the user due to its special construction. Thus problem-free glazing-removal is possible, even of large panes.



### Description

### Part no.

3-piece

**40015L**

## Plastic protective strip set



for removing glued vehicle windows. Optimum protection for interior linings, the headlining and dashboard when removing passenger car and truck windows using piano or square wire. The plastic boards are quick and easy to fix in place e.g. between A/C/D pillar or dashboard and window and thus protect from damage being caused by the sharp cutting wire.

- Board 1: 750 mm x 150 mm x 5 mm
- Board 2: 500 mm x 105 mm x 5 mm



### Description

### Part no.

2-piece

**40016L**

## Glazing removal set



for windcreens with conventional rubber seal, suitable for replacing window panes and for cleaning inner seal profiles. For universal use with passenger cars, light commercial vehicles and trucks. The scope of supply includes two different hooks, a spherical mandrel, an inserting tool with 6 m nylon cable as well as an inserting tool with 6 different hoop inserts for different seal profiles



### Description

### Part no.

5-piece

**40007L**

## Glazing removal tool set

for removing glazing from glued window panes, comprising:

- door lining lever
- pane cutting blade
- glazing removal blade with pulling cord
- piercing awl
- pair of handles for glazing removal wire
- one roll of wire



Description

7-piece

Part no.

40002L

## Glazing removal tool set

This set contains high-quality tools for cutting vinyl adhesive mass and urethane for car window applications:

- glazing removal blade 600 mm
- glazing removal blade 300 mm
- exchangeable body rebate scraper, 300 mm (3-piece 1.25 - 1.5 - 2 cm)
- wide body rebate scraper
- triangular pull-wire, 22 m
- handles for triangular pull-wire, 2-piece
- car window removal tool
- hexagon key
- wire pull-in tool
- windscreen loosening tool
- door lining loosening tool



Description

14-piece

Part no.

40006L

## Glazing removal blade

with pull cord



Description

Complete blade  
Replacement blade

Part no.

40002L-1  
40002L-2

## Pair of handles

for pane wire



Part no.

40002L-3

## Wire guiding probe

with stainless steel hollow tube ca. 100 mm long for threading cutting wire through

- Aluminum handle



Part no.

40002L-5



## Parting awl



Makes it easier to insert wire into vehicles with deep cockpits, since the tool adapts to curved shapes. Wire insertion is made easier by the fork opening



Part no.  
40002L-6

## Wire steady



for glazing removal, optional supplement to assortment 40002L. The steady makes it easier to pull and route the cutting wire in the case of deep cockpits and in particular long panes



Description	Length	Part no.
Draht-Gegenhalter XXL version	355 mm	40002L-4

## Cutting wire



twisted version, highly flexible for separating beads that are difficult to access



Description	Diameter	Part no.
22,5 m coil, twisted version	0,75 mm	400022L

## Cutting wire



rust-free square glazing removal wire in top quality with analysis certificate, strong cutting performance on glue beads that are easy to access



Description	Part no.
50 m coil, square version. tensile strenght up to 2400 Nm	400021L

## Vehicle window assembly frame



for the quick and simple assembly and disassembly of larger vehicle windows

- with 4 mobile suction cups which have a warning line when there is a loss of vacuum pressure
- with 4 mobile feet for comfortably casting off the frame e.g. onto a SW-Stahl factory vehicle
- suction cup diameter 150 mm
- aluminum frame
- load capacity 100 kg



Part no.  
40017L



## Single suction cup

with quick-action release lever, indispensable for body work or transporting almost flat goods

- max. lifting force ca. 40 kg
- working load ca. 25 kg
- cup diameter 115mm



Part no.  
**40001L**

## Double suction cup set

for the installation and removal of glued window panes or for the transport of other products

Suction cup:

- max. lifting force ca. 85 kg
- working load ca. 42 kg
- cup diameter 120 mm
- flexible heads

clamping strap:

- 5 m x 24 mm



Description

2 Double suction cups + ratchet clamping strap  
Ratchet clamping strap 5 m

Part no.  
**40000L**  
**30005L**

## Single suction cup

for the installation and removal of glued window panes or for the transport of other products

Suction cup:

- max. lifting force ca. 85 kg
- working load ca. 42 kg
- cup diameter 120 mm
- flexible heads



Description

1 Double suction cups

Part no.  
**400000L**

## Special scraper set

with sharp edges in different widths, e.g. for glass adhesive

- 5 blades each 12, 16, 20 mm + 16 mm/53°
- 5 trapezoidal blades
- Universal blade
- 2-component scraper handle



Description

27-piece  
10 blades 12 mm  
10 blades 16 mm  
10 blades 20 mm  
10 blades 16 mm / 53°  
10 trapezoidal blades

Part no.  
**94860L**  
**94861L**  
**94862L**  
**94863L**  
**94864L**  
**90657L**





## Professional scraper



stainless, with extra sharp blade, ideal for window adhesive



**Description**  
Balde width: 30 mm

**Part no.**  
**94825SB**

## Seal scraper set



stainless, handle lengths each 115 mm

- 100 x 31 mm, thickness 1.1 mm
- 100 x 31 mm, thickness 2.4 mm
- 50 x 20 mm, thickness 1.1 mm
- 50 x 20 mm, thickness 2.4 mm



**Description**  
4-piece

**Part no.**  
**94840L**

## Quality scraper set



with plastic handle,  
Blade width 23 mm, length 240 mm



**Description**  
2-piece  
Sticker scraper  
Seal scraper

**Part no.**  
**94820L**  
**94810SB**  
**94815SB**

## Scraper and hook set



hardened,

- scraper 275 mm
- scraper 215 mm
- hook 90°
- parting awl
- hook 45°



**Description**  
5-piece

**Part no.**  
**94880L**

## Scraper set



with 40 mm wide, exchangeable blades

- used for all applications
- due to its extra small design, can also be used in hard to reach places



**Description**  
2-piece

**Part no.**  
**90603SB**

## Moulded inserts



for RX-Edition mobile tool chest

Large inlay for a complete drawer equipped as follows:

- Assembly wedge set, 5-part
- Wiper arm extractor, 9-part
- Terminal extractor, cars and trucks
- Telescope magnetic lift, 120 - 650 mm, 7.5 mm
- Door panelling remover, 260 mm
- Special insert T80 with hole for BMW wiper arm



Description	Length	Width	Height	Part no.
19-piece glass fitting set	410 mm	570 mm	40 mm	Z3000-10

## Moulded inserts



for RX-Edition mobile tool chest

Large inlay for a complete drawer equipped as follows:

- One-man glass removal tool set
- Special scraper set, 27 parts
- 50 m square wire, up to 2,400 Nm
- 22.5 m wire, twisted, highly flexible
- Glass removal knife set
- Wire feed probe, 100 mm
- Wire retainer, 355 mm
- Parting awl
- Side cutter, 180 mm
- Telephone pliers, 200 mm



Description	Length	Width	Height	Part no.
39-piece glass fitting set	410 mm	570 mm	40 mm	Z3000-11

## Moulded inserts



for RX-Edition mobile tool chest

Large inlay for a complete drawer equipped as follows:

- Compressed air glass remover
- various blades, 18-36-52-63-90 mm long
- Professional scraper, blade 1.1 x 30 mm
- Safety eyewear according to DIN EN 166
- Glass removal set, cars and trucks



Description	Length	Width	Height	Part no.
17-piece glass fitting set	410 mm	570 mm	40 mm	Z3000-12

# Windscreen Wiper / Cleaning

## Windscreen wiper arm remover

especially for VAG rear wipers

- Opening 30-60 mm



VW  
Audi

Part no.  
10127L



## Windscreen wiper arm remover



Reliably prevents damage to the body and to the windscreen wiper arm.

BMW

- 85 mm height
- spanwidth 16 - 41 mm
- internal dimension: 14.5 mm



Description

Part no.

Fromzieher

10120L

## Windscreen wiper arm remover



for universal use, extra compact and light version with narrow base for cramped conditions



Part no.

10126L

## Windscreen wiper arm remover



Reliably prevents damage to the body an to the windscreen wiper arm

BMW  
Rolls Royce

- adjustable spring-loaded mechanism 16-38 mm
- thus almost universally suitable for BMW 3-series, 5-series, 6-series, 7-series, 8-series, Z4, Z8 roadster, X5 and Rolls Royce Phantom
- used as BMW OE-No. 616060

Model codes:

E12, E21, E23, E24, E28, E30, E30c, E31, E32, E32/3, E34, E36, E36/2, E36/3, E36/5, E36/7, E36/c, E38, E38/3, E39, E39pl, E46, E46/16, E46/2, E46/3, E46/5, E46/c, E52, E53, E60, E65, E66, E67, E85, E61, E63, E64, E71, E81, E82, E83, E86, E87, E88, E90, E91, RR1, RR2



Description

Part no.

Adjustable remover

10123L

## Screwdriver bit, T profile with hole



for BMW wiper arm, T80 with hole, 12,5 mm (1/2"), for E31, E38, E39

BMW

used as BMW OE-Nr. 616010



Part no.

10121L

## Wiper removal set

Makes the absolute straightforward removal of all standard wiper arms possible. Best application possibilities with corroded and stuck wiper arms. Best possible protection for integrated wiper nozzles thanks to hammer technology.

- 1 impact weight
- 1 pressure spindle
- Pulling bell 1: Alfa-Romeo, Audi, BMW, Citroën, Fiat, Ford, Honda, Jaguar, Mazda, MG-Rover, MB, Mitsubishi, Opel, Peugeot, Renault, Seat, Škoda, Volvo, VW, Mercedes-Benz
- Pulling bell 2: Alfa-Romeo, Audi, BMW, Citroën, Fiat, Ford, Honda, Hyundai, Jaguar, Land Rover, Mercedes-Benz, Opel, Peugeot, Renault, Saab, VW, Mercedes
- Pulling bell 3: Alfa-Romeo, Audi, BMW, Fiat, Citroën, Ford, Mazda, Mercedes-Benz, Mitsubishi, Opel, Peugeot, Smart, Volvo, VW
- Pulling bell 4: Citroën, Hyundai, MB, Opel, Mercedes-Benz
- Pulling bell 5: Alfa-Romeo, Audi, BMW, Jaguar, Land Rover, Mazda, MB, Volvo, VW
- Pulling bell 6: Citroën, Ford, Peugeot



**Audi**  
**BMW**  
**Citroën**  
**Ford**  
**Mercedes-Benz**  
**Opel**  
**Peugeot**  
**Renault**  
**VW**



Description	Part no.
8-piece	<b>10122L</b>
Pulling Bell 1 out of wiper arm removal set 10122L	<b>10122L-1</b>
Pulling Bell 2 out of wiper arm removal set 10122L	<b>10122L-2</b>
Pulling Bell 5 out of wiper arm removal set 10122L	<b>10122L-5</b>

## Nozzle Adjusting Tool for Opel

for adjusting the fan nozzle of the screen washing.  
For Opel Astra J, Insignia, Cascada, Mokka



**Opel**

Part no.  
**10128L**

## Filling can

Two carrying handles and the narrow outflow opening allow precise filling even in hard-to-reach places. Ideal for service or petrol station use.

- outlet opening Inside Ø 10 mm / outside Ø 16 mm
- ideal for oil, fuel and cleaning fluids
- temperature resistant from -40 ° C to 85 ° C
- not calibrated



Description	Product property	Part no.
9 litre	non calibrated	<b>07381L</b>



## Steering wheel sleeve remover



VW

for removing adapter sleeves on the steering column with VAG vehicles e.g. Golf II / Golf III / Golf IV, Jetta / Passat from '88 / Vento.

By placing the clamping device onto the adapter sleeve and then clamping using the slide sleeve, the spindle can be screwed against the steering column using a size 22 key or socket spanner and thus pulls the adapter sleeve off. This is necessary during repair work e.g. on the indicator switch etc.



Part no.

**09536L**

## Airbag tool set



for removing the airbag units as well as for installing and dismantling airbags on VAG, BMW etc.



Audi  
BMW  
Seat  
Škoda  
VW  
Mercedes-Benz  
Opel

Description

10-piece

Part no.

**04403L**

## Screwdriver bit, T profile with hole



especially for VAG airbags



Audi  
Seat  
Škoda  
VW  
BMW  
Mercedes-Benz  
Opel

Profile



Size

T 30

Length

165 mm

Part no.

**04401L**

# Doors / Door Trim

## SAUER Plastic Welder PW320



Plastic welding unit for welding cracked or broken plastic parts such as bumpers, inner fenders, plastic coverings etc.

Product benefits:

- Hot air also reaches spots around corners
- Pinpoint heating of objects
- Self-sufficient unit
- Stepless temperature adjustment
- Stepless adjustment of air volume

Techn. data:

- Heat output: 320 W
- Current consumption: 3.15 A
- Power supply: 230 V
- Air temperature: 150–500°C
- Length of hose package: 1.18 m
- Weight: 3.9 kg



Part no.

**70100900**



## Hot stapler plastic repair kit

- to repair cracks and similar damages to plastic parts such as bumpers, coverings or fairings etc. (above 1 mm thickness)
- Also suitable for synthetic material with a glass fibre content of 40% max.
- Heating element with holder for different repair pins. The set contains 3 types (U-shape 0.8 mm / W-shape 0.8 mm / V-shape 0.8 mm diameter, 100 pcs. each)

The repair pins are pressed into the crack and give long lasting stability to the plastic part. After cooling down the projecting wires are cut and the plastic part can be ground, filled up and lacquered.



ⓘ **Do not use with pure glass fibre plastic or carbon!**

Description	Part no.
Plastic repair kit	<b>23060L</b>
U-Form	<b>23060L-1</b>
W-Form	<b>23060L-2</b>
V-Form	<b>23060L-3</b>
F-Form	<b>23060L-4</b>
S-Form	<b>23060L-5</b>

## Multi-purpose frame

with rubber-coated supports for the placement of body parts e.g. during window or painting work, or for transporting large bulky vehicle parts. The height and length adjustment possibilities makes the frame suitable for almost any vehicle. Can be collapsed for compact storage after use.

- With 4 sturdy casters, 2 of which can be locked in place
- Load capacity up to approx. 100 kg
- Width from 200 mm to 1380 mm
- Height from 840 mm to 1320 mm
- Length 855 mm (not adjustable)



Load capacity	Part no.
100 kg	<b>20340L</b>

## Mounting kit for parking sensors

For replacing defective brackets for parking sensors or punching holes in unprepared plastic bumpers.

The set contains three punches in the diameters 18.2 mm, 18.6 mm and 26.0 mm for the punching out of holes in plastic push rods. Two fixing mandrels serve to lock holders with double-sided adhesive tape. Various other holding devices fix the holders of the parking sensors during the bonding.

The set is optimized for VW, Audi, Seat and Škoda vehicles.



Part no.
<b>23070L</b>





## Pipe wrench, Hexagonal



10 mm hex with 6.3 mm (1/4") drive

**BMW**  
Mercedes-Benz  
Audi

e.g. for:

- Bumper bolts on Mercedes-Benz and Audi A3 Sportback
- To set the hand brake on BMW E30, E32, E34



Size	Length	Part no.
10 mm	160 mm	04408L

## Decorative strip wedges



made of high-strength special plastic  
For work on decorative strips, rubber seals, dashboard, door lining, switches



Description	Part no.
3-piece	94800L
60 x 200 mm	94801L
30 x 200 mm	94802L
Mounting wedge 20 x 265 mm	94803L

## Mounting wedge set



made of high-strength special plastic 160 - 200 mm long

For work on decorative strips, rubber seals, dashboard, door lining, switches, sealing plugs



Description	Part no.
5-piece	94890L

## Mounting wedge set



made of glass-fibre reinforced plastic  
For interior linings, for the damage-free installation and removal of lining parts, plastic clips, rear view mirrors etc. even in spots that are difficult to reach.

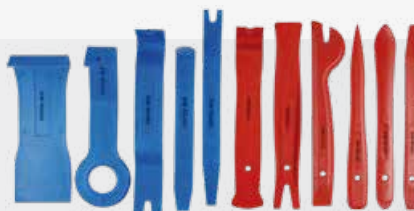

Description	Part no.
11-piece	94807L

## Clip remover set



INOX - stainless steel with 2-component plastic handles

- U-shape lever (inner 8.2 mm / outer 31.5 mm)
- V-shape lever 38 mm (inner 4-12.5 mm / outer 31.5 mm)
- U-shape lever (inner 6.15 mm / outer 12.8 mm)
- V-shape lever 13 mm (inner 1-4,4 mm / outer 12,8 mm)
- U-shape lever 38 mm, extra long, curved (inner 8.4 mm / outer 31.4 mm)



Description	Part no.
5-piece	94845L



## Volvo mounting clip assortment



Volvo

the box contains the following clips:

- 30 x Nissan push-type retainer (OE: 8099905N07 / 9046707043)
- 25 x Volvo bumper cover retainer (OE: 1268176)
- 50 x BMW moulding clip (OE: 51131804205)
- 50 x Volvo body side moulding clip (OE: 171583585 / 591740)
- 30 x Nissan push-type retainer (OE: 6384801G00)
- 25 x Volvo rocker panel retainer (OE: 9133417)
- 50 x Volvo bonnet insulation & radiator retainer (OE: 9133073)
- 30 x Volvo black fir tree retainer (OE: 3272075327462B)
- 25 x Volvo grey fir tree retainer (OE: 327462A)
- 24 x Volvo bonnet prop rod clip (OE: 3923712)
- Peugeot/Citroën push-type retainer (OE: 790307216 / 947098 / A0009903492)
- Fiat interior mounting retainer (OE: 4292906)



**Description**  
350-piece

**Part no.**  
S8015

## Plastic rivets assortment



the box contains the following clips:

- 15 x Ford plastic rivet for cowl grill (OE: N804583S)
- 30 x VW plastic rivet (OE: 1758535570C / 6503800)
- 15 x Ford plastic rivet (OE: 14063981 / 6500911 / N8030433)
- 25 x Chrysler connect blind rivet retainer (OE: 6500898)
- 15 x BMW connect blind rivet retainer (OE: 51717002953)
- 15 x GM plastic rivet (OE: 15506827)
- 15 x GM plastic rivet (OE: 14070914)
- 20 x Chrysler connect blind rivet retainer (OE: 25524005)
- 35 x GM Connect blind rivet retainer (OE: 204655395 / 6004212)
- 15 x GM connect blind rivet retainer (OE: 10036503)
- 15 x GM connect blind rivet retainer (OE: 10109689)
- 15 x Ford plastic rivet (OE: 6503860 / N804675S)



**Description**  
235-piece

**Part no.**  
S8016

## Fir tree fixings assortment



the box contains the following clips:

- 30 x Ford fir tree fixing (OE: 388577S)
- 30 x Ford fir tree fixing (OE: 6998849)
- 15 x universal fir tree fixing, white (OE: 6003423)
- 15 x VW fir tree fixing (OE: 385661 / 6003349 / N989022)
- 50 x Chrysler connect weatherstrip retainer (OE: 20699808 / 6502328)
- 10 x Ford connect bumper fascia (OE: N804379S)
- 35 x Mazda connect hood insulation retainer (OE: F22Z16774A / 6508197AA)
- 30 x GM connect bumper cover retainer (OE: 16674629 / N806113S)
- 50 x Nissan cowl grill fir tree (OE: 0153301781)
- 20 x VW fir tree fixing (OE: 2207713 / 514719044317 / N9020160H)
- 25 x fir tree fixing
- 30 x Toyota fir tree fixing



**Description**  
340-piece

**Part no.**  
S8017





## Renault mounting clip assortment

the box contains the following clips:

- 60 x Mercedes-Benz connect plastic barrel nut (OE: 7703074022 / A108980027)
- 65 x Renault connect push-in retainer (OE: 7703077059/14188380)
- 50 x Renault door mounting retainer (OE: 7703077421)
- 60 x Renault push-type-retainer (OE: 7703081184)
- 50 x universal connect push fit retainer
- 15 x Renault plate buckle, grey



Renault

**Description**  
300-piece

**Part no.**  
S8018

## Vauxhall/Opel mounting clip assortment

the box contains the following clips:

- 40 x Opel mounting panel retainer (OE:: 1591426 / 174864)
- 20 x Opel retaining clips (OE: 90218614)
- 100 x VW connect hammer-in retainer (OE: 7814.24 / N0385501)
- 50 x Opel retaining clip, blue (OE: 2345959 / 7701053516 / 7L5853994)
- 50 x Opel retaining clip, black (OE: 2240582)
- 40 x Opel plastic screw nut (OE: 180942)



Opel  
Vauxhall

**Description**  
300-piece

**Part no.**  
S8019

## Peugeot/Citroën mounting clip assortment

the box contains the following clips:

- 50 x Peugeot/Citroën push-type-retainer (OE: 790307216 / 947098 / A0009903492)
- 20 x Peugeot/Citroën mounting panel retainer (OE: 856535)
- 20 x Peugeot/Citroën connect side moulding grommet (OE: 357853575 / 6991W4)
- 20 x Peugeot/Citroën universal retainer
- 25 x Peugeot/Citroën retainer (OE: 694143)
- 35 x Peugeot/Citroën retainer (OE: 743707)
- 15 x Peugeot/Citroën connect buckle fixing (OE: 698317)
- 25 x Peugeot/Citroën mounting retainer (OE: 699502)
- 30 x Peugeot/Citroën mounting retainer (OE: 6995X3)
- 40 x Peugeot/Citroën mounting retainer (OE: 69945)
- 35 x Renault connect push-in retainer (OE: 14188380 / 7703077059)
- 30 x Mercedes-Benz connect plastic barrel nut (OE: 7703074022 / A108980027)



Peugeot  
Citroën

**Description**  
345-piece

**Part no.**  
S8020

## Fiat mounting clip assortment



the box contains the following clips:

- 30 x Fiat interior mounting retainer (OE: 4292906)
- 20 x Fiat push-type retainer (OE: 1459487)
- 25 x Fiat push-type retainer (OE: 1300433650)
- 8 x Fiat/BMW push-type retainer (OE: 71717421)
- 25 x Fiat/VW mounting retainer (OE: 82456515)
- 25 x Fiat mounting retainer (OE: 5757139)
- 20 x Fiat interior mounting retainer (OE: 1459387)
- 25 x Fiat mounting retainer (OE: 14188282 / 46306526 / 60507749)
- 25 x Fiat mounting retainer (OE: 14591687)
- 25 x Fiat/Iveco mounting retainer (OE: 1452387)
- 30 x Fiat/Toyota/Nissan screw grommet (OE: 83468473)
- 50 x Fiat retainer (OE: 7677865)



**Description**  
308-piece

**Part no.**  
**S8021**

## Honda mounting clip assortment



**Honda**

the box contains the following clips:

- 15 x Honda push-type-retainer (OE: 75521611000 / 90675SB003)
- 8 x Honda push-type-retainer (OE: 91502SP0003)
- 20 x Honda mounting panel retainer (OE: 91566SP0003)
- 50 x Honda hood seal retainer (OE: 91513SE003)
- 40 x Honda weatherstrip retainer (OE: 91530ST5003)
- 20 x Honda side & trunk lining retainer (OE: 91550SH3003)
- 25 x Honda screw grommet (OE: 91620SR2003)
- 5 x Honda radiator grill retainer (OE: 91578SV4003)
- 30 x Honda retainer (OE: 38529689A6300)
- 15 x Honda push-type-retainer (OE: 91512SX0003)
- 15 x Honda retainer (OE: 906876710030)
- 30 x Honda push-type-retainer (OE: 90683SA5003)
- 30 x Honda retainer (OE: 01553 / 90687SA50030)
- 15 x Honda push-type retainer (OE: 91808SM4000)
- 30 x Honda moulding retainer (OE: 91534SEO000)
- 20 x Honda side marker clip (OE: 34355SD2003)
- 30 x Toyota front grill clip (OE: 8942180270 / 9046712020)
- 20 x Toyota retainer (OE: 9046709065 / 90672671003)



**Description**  
418-piece

**Part no.**  
**S8022**



## Nissan mounting clip assortment



the box contains the following clips:

Nissan

- 30 x Chrysler/Mazda retainer (OE: 76906T300 / 813350022)
- 15 x Honda push-type-retainer (OE: 75521611000 / 90675SB003)
- 25 x Honda mounting panel retainer (OE: 8942798070 / 90667SA70030)
- 25 x Honda connect screw grommet (OE: 78856R4301 / 906836930000)
- 10 x Nissan nylon U-nut (OE: 5378914010 / 63848D400)
- 25 x Nissan square nut retainer (OE: 68425H5000)
- 15 x Nissan push-type-retainer (OE: 1007932 / 6384401A00)
- 30 x Nissan push-type-retainer (OE: 1099830880 / 8942981190 / KK37668868)
- 8 x Nissan bumper cover connecting retainer (OE: 0155301393 / BF8250233)
- 20 x Nissan push-type-retainer (OE: 6384801G00)
- 50 x Nissan retainer (OE: 62869N4700)
- 15 x Nissan grill grommet (OE: 62380U7400)
- 20 x Nissan push-type-retainer (OE: 7688257A00)
- 40 x Nissan radiator grill retainer (OE: 6684101G00)
- 10 x Nissan push-type-retainer (OE: 6387801E10)
- 15 x Nissan flush sheet plug (Nissan universal)
- 15 x Nissan push-type-rivet (OE: 6385401A00)
- 40 x Toyota retainer (OE: 015530172 / 9046707050)



Description

Part no.

408-piece

S8023

## Mazda mounting clip assortment

the box contains the following clips:

Mazda

- 50 x Mazda retaining clip (OE: B45556741 / F1CZ16674A)
- 20 x push-type retainer (OE: 2042301 / MB345544)
- 25 x connect square nut retainer (OE: 0128100501 / 999100402)
- 20 x retaining clip (OE: 9095001248 / B0016830200)
- 25 x push-type-retainer (OE: 90657SA60030 / 9418687 / N30413356A)
- 40 x connect retaining clip (OE: 0155300291 / 992640543A)
- 30 x connect hood insulation retainer (OE: 6508197AA / F22Z16774A)
- 5 x connect bumper cover retainer (OE: BF8250233)
- 20 x connect interior mounting retainer (OE: B1016825200)
- 15 x push-type-retainer (OE: B09251833)
- 50 x connect weatherstrip retainer (OE: 6786889101 / G03158762)
- 5 x Mazda bumper retainer (OE: BF6750033)
- 20 x rod end clip (left side) (OE: 992780405)
- 20 x rod end clip (right side) (OE: 992780404)
- 50 x Mazda fir tree retainer (also for general use) (OE: 99249051B)
- 15 x Mazda push-type-retainer (OE: BC1DSA145)
- 50 x Mazda mounting retainer (OE: 992640543A)
- 15 x connect wheel housing retainer (OE: 9046709139)



Description

Part no.

475-piece

S8024



## Mitsubishi mounting clip assortment

the box contains the following clips:

- 50 x Mitsubishi square nut retainer (OE: 9018905013)
- 30 x Mitsubishi screw grommet (OE: 9018906001 / MU480033)
- 15 x Mitsubishi push-type-retainer (OE: MB253964)
- 15 x Mitsubishi bumper cover grommet (OE: MB271999)
- 10 x Mitsubishi push-type-retainer (OE: MR200300)
- 30 x Mitsubishi screw grommet (OE: MU480034)
- 10 x Mitsubishi push-type-retainer (OE: MR138807)
- 10 x Mitsubishi retainer (OE: HB121467)
- 40 x Mitsubishi push-type-retainer (OE: MB696120)
- 40 x Nissan rock panel retainer (OE: MB846992)
- 50 x Toyota grill clip (OE: 8942180270 / 9046712020)
- 30 x Toyota grommet round nut retainer (OE: 0128100231 / 9018906001)



Mitsubishi



**Description**  
370-piece

**Part no.**  
S8025

## BMW mounting clip assortment

The box contains the following clips:

- 80 x Barrel Nut (OE: 51311802258)
- 35 x Bumper-Mounting-Retainer (OE: 51118174185)
- 35 x Push-Type-Retainer (OE: 51481938725)
- 40 x Retainer (OE: 703867299 / 823867299)
- 20 x Push-Type-Retainer (OE: 51131960054)
- 80 x Retainer (OE: 51131804205)



BMW

**Description**  
290-piece

**Part no.**  
S8026

## Ford mounting clip assortment

the box contains the following clips:

- 25 x Ford fir tree shield retainer (OE: 388577S)
- 20 x Ford push-type-retainer (OE: 10139622 7 1673046 / 6508197AA)
- 30 x Mazda retainer (OE: B45556741 / F1CZ16674A)
- 15 x Ford inner fender push-type-retainer (OE: N8011925S)
- 40 x Ford weatherstrip retainer (OE: N806289S)
- 30 x Ford square screw nut (OE: N379830S)
- 10 x Ford retainer (OE: N387496S)
- 35 x Ford fir tree shield retainer (OE: N803170S)
- 10 x Ford push-type-retainer (OE: W704958S300)
- 20 x Ford push-type-retainer (OE: NAU156145 / W706713S300)
- 35 x Ford fir tree shield retainer (OE: N388246S)
- 15 x Ford retainer (OE: N387944S)
- 20 x Ford push-type-retainer (OE: N805231S)
- 15 x Ford retainer (OE: W705532S300)
- 15 x Ford push-type-retainer (OE: W710250S300)
- 35 x GM tail light retainer (OE: 16500308 / 6500787)
- 30 x Mazda hood insulation retainer (OE: 6508197AA / F22Z16774A)
- 15 x Nissan push-type-retainer (OE: 1007932 / 6384401A00)



Ford



**Description**  
415-piece

**Part no.**  
S8027



## Mercedes-Benz mounting clip assortment

Mercedes-Benz

The following clips are included in the cassette:

- 30 x Mercedes Connect Plastic Barrel Nut Pack (OE: 7703074022 / A108980027)
- 15 x Mercedes Push Type Retainer (OE: A1269900392)
- 30 x Mercedes Retaining Clip (OE: A0019882981)
- 25 x Mercedes Push Type Retainer (OE: A1249900492)
- 5 x Mercedes Retaining Clip (OE: A0019888081)
- 10 x Mercedes Retaining Clip (OE: A1249880492)
- 15 x Mercedes Push Type Retainer (OE: A9904692)
- 40 x Mercedes Push Type Retainer (OE: A0009908492)
- 30 x Mercedes Retaining Clip (OE: A0019880325)
- 15 x Mercedes Fir Tree Fixing (OE: A1406980260)
- 20 x Mercedes Retaining Clip (OE: A0019885081)
- 35 x Mercedes Retaining Clip (OE: A0019884481)



Description  
270-piece

Part no.  
**S8028**

## VW mounting clip assortment

VW

The following clips are included in the cassette:

- 20 x AUDI / VW Retaining Clip (OE: 3A0853575 / 3A0853575A)
- 30 x AUDI Connect Door Moulding Clip (OE: 6U085733)
- 20 x VW Fir Tree Fixing (OE: 2207713 / 514719044317 / N9020160H)
- 30 x VW Connect Hammer-In Retainer (OE: 7814.24 / N0385501)
- 5 x VW Retaining Clip (OE: 1H0868243B)
- 30 x VW Screw Grommet (OE: N90833801)
- 15 x VW Plastic Clip (OE: 4A0853825 / 4A0853825A)
- 10 x VW Retaining Clip (OE: 3B0853576)
- 25 x VW Retaining Clip (OE: 1H0819055B01C)
- 15 x VW Green Plastic Retainer (OE: 443853909A)
- 30 x VW Grey Push Type Retainer (OE: 171885767)
- 25 x VW Plastic Screw Nut (OE: 191941142)



Description  
255-piece

Part no.  
**S8029**

## AUDI mounting clip assortment

Audi

The following clips are included in the cassette:

- 10 x Push-Type Retainer (OE: 1H0867199A / 51481915964)
- 10 x Connect Mounting Retainer (OE: 1H086243 / 1H0868243B)
- 10 x Connect Retaining Grommet (OE: 1H0853585A)
- 5 x Connect Retaining Grommet (OE: 3A0853575)
- 20 x Connect Retaining Grommet (OE: 3B0853575)
- 20 x VW Retainer Clip (OE: 3A0853575 / 3A0853575A)
- 10 x AUDI Plastic Clip (Also suits VW) (OE: 4A0853825C)
- 15 x AUDI Hood Strut Socket (OE: 1H0823397)
- 15 x AUDI Push Type Retainer (OE: 1H0819055C01C)
- 10 x Connect Door Mounting Retainer (OE: 3B0838243 / 3B0868243)
- 20 x Connect Side Moulding Grommet (OE: 357853575 / 6991W4)
- 15 x VW Plastic Clip (Also suits Audi) (OE: 4A0853825 / 4A0853825A)



Description  
160-piece

Part no.  
**S8030**



## Bodyshop metal fasteners assortment

the box contains the following parts:

- 25 x Audi / VW metal speed fastener star centre (OE: N90335004 / N90335006)
- 20 x sheet metal screw c/w captive washer (OE: 07119916946 / N914031006203)
- 25 x Audi / VW (OE: N90796501)
- 30 x sealing rivet with 12.8 mm flange for general use (OE: 9026905065)
- 50 x Toyota sealing rivet with 6.2mm flange (OE: 9026904051)
- 50 x Toyota sealing rivet with 8.7mm flange (OE: 9026904053)
- 25 x Toyota sealing rivet with 12.1 mm flange (OE: 9026905054)
- 50 x metal U-nut No. 8 x 21.0 mm
- 30 x black sheet metal screw c/w captive washer
- 30 x black sheet metal screw c/w captive washer
- 35 x black rivet with 12.0 mm flange for general use
- 30 x black stem rivet 5/32 in. standard flange for general use



**Description**

400-piece

**Part no.**

**S8034**

## Toyota/Lexus mounting clip assortment

the box contains the following clips:

- 10 x Toyota hood insulation fixing (OE: 9046709006)
- 25 x Toyota round nut retainer (OE: 128100231 / 9018906001)
- 40 x Toyota connect square nut retainer (OE: 75521611000 / 96706P0105)
- 10 x Toyota connect nylon U-nut (OE: 9017905060)
- 25 x Toyota connect rocker panel clip (OE: 9046711063)
- 25 x Toyota connect moulding clip (OE: 7539533030)
- 20 x Toyota/Lexus push-type-retainer (OE: 9046707138)
- 35 x Toyota/Lexus push-type-retainer (OE: 9046707117)
- 30 x Toyota/Lexus retaining clip (OE: 9046709138)
- 15 x Toyota/Lexus bumper cover retainer (OE: 9046709101)
- 15 x Toyota/Lexus bumper cover retainer (OE: 9046709093)
- 10 x Toyota/Lexus side panel retainer (OE: 7504933010)
- 20 x Toyota/Lexus door moulding clip (OE: 7503933060)
- 20 x Toyota/Lexus mounting panel retainer (OE: 677711250)
- 15 x Toyota/Lexus push-type-retainer (OE: 9046709143)
- 20 x Toyota/Lexus hood insulation retainer (OE: 9046708124)
- 10 x Toyota/Lexus bumper push-type-retainer (OE: 9046709096)
- 15 x Toyota/Lexus hood insulation fixing (OE: 9046709050)

**Lexus  
Toyota**



**Description**

360-piece

**Part no.**

**S8035**



## Cable tie set

the assortment contains the following cable tie types:

- 100 x red 2.5 x 100 mm
- 100 x yellow 2.5 x 100 mm
- 100 x blue 2.5 x 100 mm
- 100 x green 2.5 x 100 mm
- 100 x white 2.5 x 100 mm
- 100 x black 3.6 x 150 mm
- 100 x white 3.6 x 100 mm
- 100 x red 4.8 x 200 mm
- 100 x yellow 4.8 x 200 mm
- 100 x blue 4.8 x 200 mm
- 100 x green 4.8 x 200 mm
- 100 x white 4.8 x 300 mm



**Description**  
1.200-piece

**Part no.**  
**S8036**

## Emergency car-opener set

with description of use



ⓘ **Can only be sold to authorised specialist garages!**

**Part no.**  
**S3541**

## Emergency car-opener set

in bag, for universal use, heavy-duty version



ⓘ **Can only be sold to authorised specialist garages!**

**Part no.**  
**S3546**

## Door expander pad

The vehicle door can be opened slightly without damage to paintwork and body, in order to introduce the usually metallic door opener. Also makes window removal work easier.



**Part no.**  
**S3544**





## Assortment of expander pads



for universal use, e.g. for pushing off interior linings, removing glass or aligning/positioning vehicle body parts.

Dimensions:

- Square 160 x 160 mm
- Rectangular 185 x 60 mm
- Rectangular with rounding 185 x 43 mm
- Kidney-shaped 320 x 115 mm
- Air pump with 450 mm hose in a practical hang-up bag



Description	Part no.
5-piece	S3547

## Car door protection mat



ideal for avoiding damage to paint when getting in and out of the car, e.g. on garage or carport walls. High-quality soft foam mats with abrasion-resistant surface and self-adhesive reverse side, for fixing on clean, dry substrates (e.g. plaster, wood or metal poles).

The protection mat, which is made of polyethylene (PE) can be cut to size as required and offers effective yet gentle protection against impact and scratches.



⚠ **Avoid installation below 5°C!**

Length	Width	Part no.
200 mm	2000 mm	07306L

## Plastic rivet gun set



for the fast and professional riveting of wheel housing, sill and interior panelling as well as dashboards e.g. on the BMW X3, X5, X6 / Chrysler / Ford / Jaguar / Saab etc.

Contains the following sizes:

- 10 pieces in Ø 5.0 mm x 15.8 mm
- 10 pieces in Ø 5.0 mm x 17.2 mm
- 10 pieces in Ø 6.6 mm x 17.2 mm
- 10 pieces in Ø 6.3 mm x 25.2 mm
- incl. 1 rivet gun for plastic rivets



**BMW**  
**Chrysler**  
**Ford**  
**Jaguar**  
**Saab**

Description	Part no.
41-piece	42761L
10 pieces in Ø 5.0 mm x 15.8 mm	42761L-1
10 pieces in Ø 5,0 mm x 17,2 mm	42761L-2
10 pieces in Ø 6,6 mm x 17,2 mm	42761L-3
10 pieces in Ø 6,3 mm x 25,2 mm	42761L-4

## Removal hooks for rear lamps

with plastic testers for the damage free removal of vehicle lamps. Ideal for clipped-in lamps.

Dimensions of the blades:

- straight removal hook: 198 x 17 x 1.2 mm
- removal hook (taken off): 205 x 17 x 1.2 mm
- plastic testers: 198 x 18.4 x 0.7 mm

ⓘ **Not to be used with screwed in lamps!**



Description	Part no.
2-piece	94809L

## Special door spring pliers

with insulated handles for the removal and fitting of safety clips on window winding handles, sunshades, rear mirrors etc.

Damage to door linings is reliably avoided



Length	Part no.
220 mm	S3542

## Special detaching pliers

reliably avoids damage to all surfaces  
e.g. for door panels

- used equivalent to OEM VW 3392 or Seat T20065



Length	Part no.
200 mm	94804L

## Door lining loosener

For universal use for door linings and attachment clips  
e.g. on the windscreen



Length	Part no.
260 mm	94805L

## Door lining loosener set

angle 15 degrees, for fast, easy removal of interior linings

- universal use through 3 different sizes 4, 8 and 10 mm
- two different lengths 235 mm and 495 mm
- good handling through appropriately formed handle
- with suspension hole



Description	Part no.
6-piece	94885L



## Hinge tool, T profile without hole

Special tool for VAG



VW



Description	Profile	D	Part no.
Hinge tool Golf III		T 40 / 45	04400L
Hinge tool Golf IV		M 8 / 10	04405L

## Door hinge assembly set

for adjusting the door hinges.

With angled ratchet and an assembly lever with 8 mm hexagon bit socket.

- Incl. 7 bits
- T-profile T30, T40, T45, T50
- XZN tripe square XZN8, XZN10, XZN12

The tight space requirement and large 60° rotation range make exact work possible.

Suitable for:

Audi, VW, Seat, Škoda, Mercedes-Benz, Renault, etc.



VW

Audi

Mercedes-Benz

Renault

Seat

Škoda

### ⓘ Tighten screws with torque wrench!

Description	Length	Part no.
9-piece		04407L
Ratchet	318 mm	04407L-1
Bit ZXN8	25 mm	04407L-2
Bit ZXN10	25 mm	04407L-3
Bit ZXN12	25 mm	04407L-4
Bit T30	25 mm	04407L-5
Bit T40	25 mm	04407L-6
Bit T45	25 mm	04407L-7
Bit T50	25 mm	04407L-8
Assembly Lever	300 mm	04407L-9

## Hinge tool set

for universal use on almost all vehicles for doors, boots and tailgates.

The ball joints allow use at all installation points. The 13 mm drive is suitable for ring spanners, sockets using ratchets etc.

Chrome-vanadium, **special hardening**



Audi

Renault

Seat

Škoda

VW



Description	Profile	D	Part no.
5-piece			04500L
		M 8	04500-XZN8
		M 10	04500-XZN10
		8	04500-SW8
		T 40	04500-T40
		T 45	04500-T45

## Door bolt fitting tool

for removing and fitting door hinge clamping sleeves.



Opel

Ford

Citroën

Peugeot

Description	Part no.
Mounting tool	08200L

## Expulsion bolt

for door bolt fitting tool 08200L, e.g. Opel



Opel



Description	Part no.
5 mm	08201L
4 mm	08202L

## Door lock tool, Spline

Special tool for lock systems on door and boot of different VAG models such as Golf IV, Passat and others



VW  
Audi  
Seat  
Škoda



Profile	Size	Length	Part no.
○	M 4	120 mm	04406L

## Locking cylinder installation aid

for key pattern with internal spring.  
For fast and exact repairs to the door lock.

Suitable for:

- VW Passat, Vento, Beetle, Lupo, Golf IV (not Golf Cabrio!)
- Seat
- Škoda



Seat  
Škoda  
VW



Part no.  
301553L

## Door handle dismantling tool

for the fast and simple loosening of the locking hook which is difficult to reach when removing door handles without a locking cylinder (comparable with VW T10389).

Suitable for VW:

- Passat B6 (3C) from '05
- Tiguan from '08
- Golf VI from '08
- Also suitable for door lock installation, Fox from '05



VW

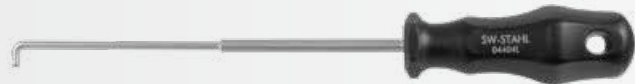

Part no.  
04404L

## Special T-handle socket spanner, 5 Star with hole, Extra long

Special T-handle socket spanner for adjustment work on the wing mirrors of Mercedes-Benz W203 and 211 (C + E)



Mercedes-Benz

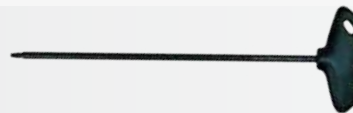

Profile	Size	Length	Part no.
⊗	IP 20	257 mm	04402L

## Gas-filled damper clamp

for keeping bonnet and boot lid open if gas-filled spring is faulty

- Jaw opening up to 30 mm



Part no.  
20500L



## Telescopic support for bonnet



e.g. for boot lid or bonnet

- adjustable from 54 - 120 cm
- can be adjusted in any position by turning the telescopic element
- for safe and comfortable working
- helpful when the original support is being replaced or during work on gas dampers and bodywork
- with rubber bases at both ends for a firm, non-slip hold
- low weight, made of aluminum



Part no.  
**20505L**

## Padded pliers set



for professional attachment of the seat covers to the upholstery, e.g.

- when replacing the seat covers or the upholstery
- when replacing the airbag sensor mat (passenger seat)
- when replacing the underseat heating mat



ⓘ **Incl. 100 clamps!**

Description	Part no.
Padded pliers set	<b>94808L</b>
100 replacement clamps	<b>94808L-1</b>

Part no.  
**94808L**  
**94808L-1**

## Bulb socket spanner



for small bulbs with socket. Also ideal for lamps in spots that are difficult to reach, e.g. dashboards and instrument clusters.



Description	Part no.
Socket spanner with handle	<b>02040L</b>

Part no.  
**02040L**

# Body and Paint

## Coating thickness gauge



for universal use for determining paint thickness on iron and NF metals, e.g. when detecting accident damage.

- digital display with lighting
- automatic switch-off
- one-hand operation
- measuring frame "Stärke": 0 bis 40 mils (0 bis 1000 µm)
- resolution: 0,1 mils/ 1 µm
- incl. bag and 2 measuring plates (iron/aluminium)
- reaction time: 1 sec
- accuracy:
  - +/- 4 dgts per 0 to 7,8 mils
  - +/- 10 dgts per 0 to 199 µm
  - +/- (3% + 4 dgts) per 7,9 mils to 40 mils
  - +/- (3% + 10 dgts) per 200 µm to 1000 µm



ⓘ **Ideal for aluminium chassis! Not suitable for plastic bodies.**

Part no.  
**72375L**

## Body straightening set

hydraulic for the spreading, pressing, clamping of body parts, 4 t compression/tensile force, in metal box. The comprehensive accessories are simply pushed in place

- Hydraulic cylinder with hand pump
- 1.6 m pressure hose
- Extensions from 5 - 50 cm
- differently shaped fittings

① Hydraulic drive



YYY



Part no.  
23040L

## Body straightening set

for pressure and special work on vehicle bodies

- Maximum pressure: 10 tons

① Hydraulic



YYY

Part no.  
23041L

## Practi-hook

forged, for universal use for many alignment and pulling jobs



YYY

Part no.  
10021L

## SAUER Uni-Heat U1230

The unit and the induction head have been designed specifically for removing small dents in the vehicle body. The targeted warming of the vehicle body pushes the dent out of the sheet metal.

### Product benefits:

- Pinpoint heating of components
- No open flames — no heating of/damage to surrounding components
- Particularly suitable for use in tight spaces
- Rapid and easy
- Saves time and increases productivity

### Techn. data:

- Heat output: 1.0 kW
- Current consumption: 10 A
- Power supply: 230 V
- Induction cable: 4.5 m
- Weight: 6 kg



CE YYY

Description  
Uni-Heat U1230  
Induction head for U1230

Part no.  
70100200  
70200201

## Aluminium hammer with changable plastic tips

Aluminum hammer with 4 plastic tips for variable use.



YYY

Description  
5-piece

Part no.  
23080L



## Panel beating hammer

with fibreglass handle and specially shaped hammer head



Part no.  
51120L

## Straightening set

in plastic case

- Multi-grip with quick-action coupling for changing the sockets
- 9 different profiles (round, pointed & flat)
- Impact tips hardened



Description  
10-piece

Part no.  
23020L

## Straightening set

in plastic case

- 3 different hammers with fibreglass handles and rubber grips
- 4 forged mallets



Description  
7-piece

Part no.  
23010L

## Dent straightening bar set

with different shapes and lengths from 200 to 1000 mm

The tool often allows dents to be repaired without any damage to the paintwork.

Extremely suitable for working in spots that are difficult to access

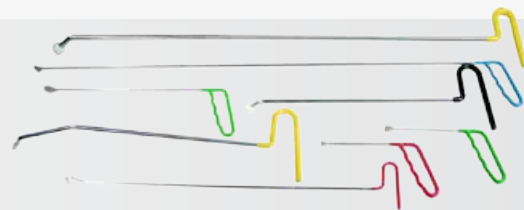

Description  
8-piece

Part no.  
23027L

## Plastic spare heads

for panel beating set 23027L

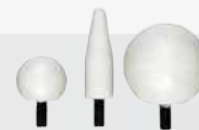

Description  
3-piece

Part no.  
23028L

## Panel-beating tool set

Scope of delivery:

- 1 special hammer (for larger bumps which are difficult to pull out)
- 1 dent-pulling unit with rubberized feet (for small dents)
- 1 hot glue gun
- 8 special glue sticks e.g. for body panels
- 9 different dent removal pads
- 1 plastic scraper for removing residual adhesive



Description  
21-piece

Part no.  
23037L



## Special adhesive sticks



- for universal use on glass, plastic, leather, metal, PVC etc.
- outstanding adhesive properties on body panels e.g. for sticking dent removal pads in place
- extra-long 300 mm
- for use with 23035L / 23037L
- also for use in standard hot glue guns with 11 mm diameter

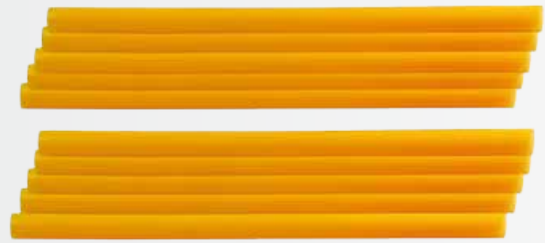

Description	D	Part no.
10 units	11 mm	23038L

## Panel-beating pad set



for use with 23037L

- 9 different shapes



Description	Part no.
9-piece	23039L

## Pneumatic beating hammer



A vacuum is created, which causes the device to stick to the body, allowing dents to be pulled out easily using the hammer.

- 3 replaceable suction cups 60, 120, 155 mm diameter
- 1,500 g impact weight
- ca. 620 mm long
- 1/4" pressure connection
- up to 100 kg pull-off force



Working pressure min./max.	Part no.
6-8 bar	23045L

## Easy-Heater



for the fast and precise heating of rusted, seized bolts and nuts or micro-encapsulated connections. Thanks to the inductive pinpoint heating, there is no need to use a welding torch which would lead to other components heating up as well. The additional generator with cooling system guarantees permanent use without unnecessary breaks.

**Including 3 heating coils which can be shaped flexible and have a long service life:**

- 25 mm at the side
- 20 mm vertical
- "pancake" coil



① The device fulfills the European standards!

Description	Part no.
5-piece	62100L
Lateral Heating Coil out of 62100L	62100L-1
Vertical Heating Coil out of 62100L	62100L-2
Pancake Coil out of 62100L	62100L-3
Flexible Heating Coil for 62100L	62100L-4
Flexible Heating Coil for 62100L	62100L-5
Heating Coil for Injectors for 62100L	62100L-6

## SAUER Uni-Heat U3230

For a wide range of tasks on vehicle bodies. Ideal for removing adhesive labels, lettering, paint, decorative strips, and insulating mats. The special induction head included also allows removal of glued-in windscreens.

In addition to the basic unit, the scope of delivery also includes the following induction tools:

- Heating pad: For heating entire areas
- Heating rod: For the pinpoint heating of e.g. screws, nuts, tie rods, and exhaust pipes.
- Special head: For removing glued-in car windscreens

### Product benefits:

- Pinpoint heating of components
- No open flames — no heating of/damage to surrounding components
- Particularly suitable for use in tight spaces
- Rapid and easy
- Saves time and increases productivity

### Techn. data:

- Heat output: 3.0 kW
- Current consumption: 16 A
- Power supply: 230 V
- Induction cable: 2.2 m
- Weight: 12.5 kg



Description	Part no.
Uni-Heat U3230	70100300
Heating pad for U3230	70200301
Induction head for U3230	70200303
Induction rod for U3230	70200304
Replacement foot switch for U3230	70200305
Replacement glove for U3230	70200302

## Hot air blower

e.g. for removing residual adhesive, heating hoses, paint-stripping work etc. with different attachments

- power 2000 Watts
- level 1: 350 ° C / 300 l / min.
- level 2: 550 ° C / 500 l / min.



Part no.  
**62005SB**

## Needle scaler attachment

The needle scaler attachment is used for the removal of coatings on solid metal parts. With the metal needles it is the perfect tool to get rust off rims, frame parts or iron fences. Additionally you easily are able to remove paint, plastering or cement.

The needle scaler is an attachment to pneumatic chippings from sets S3211 and S3213.

### Main features:

- 19 needles with diameter 2,8 mm each
- diameter of inner stud 10,1 mm
- diameter of support of thread ~ 30,5 mm



Part no.  
**S3215**

## Pneumatic chipping hammer



with 4 different chisels, compressed air coupling and pressure adjustment screw

- pneumatic chipping hammer 150 mm with retaining spring
- working pressure 6,2 bar (90 psi)
- air consumption 113 l/min
- compressed air connection 1/4"
- blow count 3000/min
- 4 pneumatic chisels
- automatic oiler
- hose adapter
- oil can



Description	Working pressure min./max.	Air consumption	Part no.
8-piece	6,2 bar	113 l/min	S3213

## Japanese spatula set



4-piece

- 50 mm
- 80 mm
- 100 mm
- 120 mm



Description	Part no.
Metal version	91301L
Plastic version	91302L

## Body file clamping fixture



for 350 mm file saw blades, diecast aluminium



Description	Part no.
Clamping fixture without blade	94040L
File blade 350 mm, diagonally milled, coarse - premium quality 9 tpi	94042L
File blade 350 mm, diagonally milled, fine - premium quality 12 tpi	94043L
File blade 350 mm, diagonally milled, fine - premium quality 12 tpi	94044L
File blade 350 mm, rotary milled, coarse - premium quality 9 tpi	94045L

## Sanding block



for body work, metal clamping fixture



Description	Length	Width	Part no.
Professional hand sander	210 mm	105 mm	60510L

## Set of steel stamping letters and numbers



alloy steel, 3 mm character height, complete from 0-9 and A-Z in a practical plastic case.



Description	Part no.
36-piece	08820L



## Steel stamping letters



for striking into steel an iron with consistent font, according to DIN 1451, engraving on offset surface and depth limitation



Description	Part no.
3 mm	08800L
4 mm	08801L
5 mm	08802L
6 mm	08803L
8 mm	08804L
10 mm	08805L

## Steel stamping numbers



for striking into steel an iron with consistent font according to DIN 1451, engraving on offset surface and depth limitation



Description	Part no.
3 mm	08901L
4 mm	08902L
5 mm	08903L
6 mm	08904L
8 mm	08905L
10 mm	08906L
12 mm	08907L

## Pneumatic sandblasting gun



Heavy-duty ABS housing

- Blasting sand tank capacity 600 cm<sup>3</sup>
- for use with regular aluminium oxide grit F46 to F100
- air connection 6.3 (1/4")
- Air consumption 3.3 litres / second
- 5 mm steel tip



Part no.  
25070L

## Pneumatic sandblasting gun



ideal for numerous applications on vehicle bodies and all metallic surfaces. For the removal of old paint, rust, heavy soiling with 4 different blasting fittings and a template for precise spot blasting, e.g. in the case of gravel throw damage

- for 6.3 mm (1/4") compressed air hoses
- working pressure 4 - 12 bar
- air consumption max. 350 l/min

- I = 15 mm
- II = 13 x 13 mm
- III = 15 x 15 mm
- IV = 13 x 15 mm

ⓘ For use with commercial blasting sand!



Description	Part no.
Sandblasting gun, complete	25065L
Replacement granulate bag	25066L





## Heat protection cover

made of fibreglass fabric, for grinding and welding.



- short-term heat resistance up to 600°C
- vermiculite coating on one side, approx. 650g/m<sup>2</sup>, anti-slip, flexible, approx. 0.7 mm thick,
- Fabric tested according to DIN EN 13501-1, class B - s2, d0, flame-retardant



Description	Length	Width	Part no.
Heat protection cover	1000 mm	2000 mm	<b>11301L</b>
Heat protection cover	2000 mm	2000 mm	<b>11302L</b>
Heat protection cover	970 mm	1280 mm	<b>11331L</b>
Heat protection cover	1500 mm	3300 mm	<b>11332L</b>
Heat protection cover	1000 mm	2700 mm	<b>11351L</b>
Heat protection cover	4400 mm	2600 mm	<b>11371L</b>
Heat protection cover	1800 mm	3650 mm	<b>11381L</b>
Heat protection cover	650 mm	650 mm	<b>11401L</b>
Heat protection cover	1100 mm	1100 mm	<b>11402L</b>

## Heat protection cover

made of fibreglass-free fabric with silicate fibres, for grinding and welding.



- short-term heat resistance up to 1300°C
- vermiculite coating on both sides, approx. 1250g/m<sup>2</sup>, anti-slip, flexible, approx. 1.4 mm thick,
- fabric tested according to DIN EN 13501-1, class A1, non-flammable



Description	Length	Width	Part no.
Heat protection cover	1500 mm	1800 mm	<b>11311L</b>
Heat protection cover	2000 mm	1800 mm	<b>11312L</b>
Heat protection cover	1800 mm	3000 mm	<b>11321L</b>
Heat protection cover	2500 mm	3000 mm	<b>11322L</b>
Heat protection cover	870 mm	1280 mm	<b>11341L</b>
Heat protection cover	900 mm	2000 mm	<b>11342L</b>
Heat protection cover	900 mm	2700 mm	<b>11361L</b>
Heat protection cover	1800 mm	3650 mm	<b>11391L</b>

## Overvoltage protection

prevents dangerous overvoltage during welding work



- maximum load 200 A
- copper cable and steel clamps with rubber protection
- length of the cable: 195 mm
- up to 12 volts



Part no.  
**32250L**

## Protective goggles

with clear lenses in the fitting and fold-down ATHERMAL lenses according to DIN GS, also suitable for spectacle wearers



Description	Part no.
Complete with lenses	<b>S3517</b>

## Protective goggles



with exchangeable lenses, splinterfree according to DIN



Description	Part no.
Welding goggles, green ATHERMAL, DIN 5	11102L
Replacement glass, green ATHERMAL, DIN 4	11120L

## Welding helmet



blacks out automatically. Due to integrated solar cell batteries are no longer necessary.

- in carbon-look
- visual range: 98 x 40 mm
- measure of the filter: 110 x 90 mm
- automatical connecting time 1/25,000 sec.
- adapting time: 0.4 sec.
- 4 half-shade levels
- 9 - 13 shade-options
- operating temperature -5°C - +55°C
- automatical control of sensitivity continuously variable



Description	Part no.
Welding helmet	11230L
Square disc	11231L
Headband	11230L-1

## Welder's protective visor



made of fibreglass  
Viewing window size: 90 x 110 mm



Description	Part no.
Protective visor fitting without viewing window	11200L

## Window

transparent, 90 x 110 mm

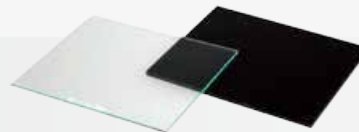

Description	Part no.
Window, transparent	11210L
Replacement lens, tinted DIN 11	11220L

## Pocket gas burner



ideal for fast heating, soldering etc.

- adjustable flame
- piezo ignition
- on/off switch (with locking device)
- storage base
- refillable gas tank (delivered empty for safety reasons!)
- working temperature 800°C



ⓘ Fill only with butane gas!

Part no.  
**62060L**





## Electro soldering gun

with VDE plug, 100 Watt, 220V, with work light



Description	Part no.
Soldering gun	6200SB
Soldering tip set (2-piece)	62001SB

## Soldering iron



for battery-operated use, ready for use in only about 15 seconds, for the fast and mobile repair of cold solder spots etc. 4.5 V / 6 W, working temperature approx. 420°C. With 3 AA batteries (not included in the scope of supply) up to 120 solder spots possible, can also be used with rechargeable batteries.

The working area is optimally illuminated by an LED. The set includes a protective cap, lead-free solder, soldering tip with removal key.  
>Shaft 3 mm / tip 0.7 mm diameter

**ⓘ Batteries are not included!**



Part no.  
61805SB

## Soldering grease



according to DIN EN 29454-1, for soft soldering and tin-plating



Description	Part no.
50 g	62050L
250 g	62052L

## Soldering fluid



according to DIN EN 29454-1, in plastic bottle with brush



Description	Part no.
50 ml	62040L

## Soldering wire



HS10 on coil, 2 mm diameter  
40 % SN, 60 % PB  
flux-cored



Description	Part no.
100 g	62010L
250 g	62011L
500 g	62012L

## Soldering tin



1000 g, in triangular rods, 11 x 11 x 11 mm, according to DIN EN 29453



Description	Part no.
40 % SN	62030L
25 % SN	62035L



## Plate bending and edging pliers



To bend metal plates at various angles

- Length 280 mm
- Width approx. 62 mm
- max opening approx. 60 mm
- high-quality/heavy design
- Dip-insulated grips"



### Head version

Head version	Part no.
Straight	92520L
45° angled	92521L
90° angled	92522L

## Hole and edge setter



with rotatable head, for setting metal edges and punching holes in metal sheets for hole spot welding

- hole diameter: 5 mm
- setting depth: 13 mm
- jaw width: 22 mm
- max. sheet thickness: 1 mm



Description	Length	Part no.
Complete pliers	315 mm	93000L
Replacement die		93005L

## Pneumatic hole and edge setting tool



ideal and fast tool for preparing spot welding work. Hole punching and setting is all done with a single tool.

- hole diameter 5 mm
- rebate width 22 mm
- rebate depth 12 mm
- max. sheet thickness: 1,5 mm



Working pressure min./max.	Air consumption	Length	Part no.
6,3 bar	113 l/min	270 mm	93020L

## Body chisel



with hand protection, secured impact head



Length	Width	Part no.
240 mm	26 mm	94000L

## Body slot-type chisel set



- 1 wide body chisel 60 mm wide x 250 mm long, with heavy hand protection
- 1 narrow body chisel 26 mm wide x 230 mm long, with heavy hand protection
- 1 narrow body chisel 26 mm wide x 230 mm long, without hand protection
- 1 special body chisel 20 mm wide x 295 mm long, with extra thin tip, with space-saving light insulation

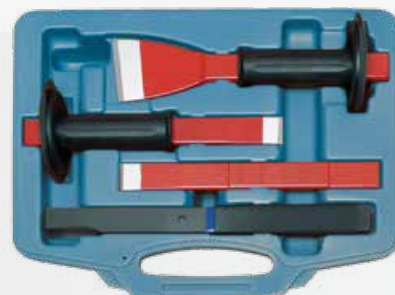

Description	Part no.
4-piece	94005L





## Body separating chisel set



single-piece blade and ergonomic handle.  
For cutting welding points on bodywork.

- 3 different shapes (straight, 15° angle, 90° angle)



Description	Part no.
3-piece	<b>94006L</b>
straight form	<b>94007L</b>
15° bent form	<b>94008L</b>
90° bent form	<b>94009L</b>

## Pneumatic angle grinder



Extra long, flat head for 100 mm grinding wheel size.

- recommended hose size 3/8"
- vibration 0.6 m/s<sup>2</sup>
- grinding wheel adapter 16 mm



① Suitable cutting wheel part no. **9600-M!**

Description	Height	Speed	D	Part no.
		14.000 rpm		<b>S3268</b>
max. 15.280 rpm.	1 mm		100 mm	<b>9600-M</b>

## Cutting wheel



for metal, cold-pressed.  
100 x 1.0 x 16 mm - suitable for pneumatic angle grinder S3268



Description	D	Height	Part no.
max. 15.280 rpm.	100 mm	1 mm	<b>9600-M</b>

## Cutting wheel



for metal, cold pressed, DSA approval, max 13,280 rpm.,  
for steel / stainless steel



Description	D	Height	Part no.
ONLY 1 mm thick, also for STAINLESS STEEL	115 mm	1 mm	<b>9601-M</b>
ONLY 1 mm thick, also for STAINLESS STEEL	125 mm	1 mm	<b>9602-M</b>
	178 mm	3 mm	<b>9604-M</b>
	230 mm	3 mm	<b>9605-M</b>

## Flap Disc



According to EN 12413. The conical shape provides an excellent angle for contour and edge grinding. Designed for machining aluminium, non-ferrous metals, mild steel, wood and plastic.



- max. 13,280 rpm.
- 115 mm diameter
- 22 mm thick

Description	Part no.
Grit 40	81301L
Grit 60	81302L
Grit 80	81303L
Grit 120	81304L

## Flap disc

According to EN 12413. The conical shape provides an excellent angle for contour and edge grinding. Designed for machining aluminium, non-ferrous metals, mild steel, wood and plastic.



- max. 13,200 rpm.
- 125 mm diameter
- 22 mm thick

Description	Part no.
Grit 40	81310L
Grit 60	81311L
Grit 80	81312L
Grit 120	81313L

## Roughing disc



for metal, cold pressed, DSA approval, max 12,200 rpm.



D	Height	Part no.
125 mm	6 mm	9654-M
230 mm	6 mm	9662-M

## Rubber support disc



115 mm for angle grinder



Description	Part no.
115 mm	81305SB



## Pneumatic air bodywork saw

for use with jigsaw blades for sawing various materials such as metal, plastic, rubber and wood. For processing these materials, sawblades with different tooth pitches are available.

- stroke frequency: 9,000 rev./min
- construction length: 235 mm
- weight: 770 g
- air consumption: 120 l/minute
- operating pressure: 6.3 bar
- sound pressure level: 72.0 dB (a)
- acceleration: 26.0 m/s<sup>2</sup>
- max. cutting output: 1.2 mm



① **Delivery incl. 2 sawblades 70624L (24 teeth)**

Operating pressure	Air consumption	Length	Part no.
max. 6,3 bar	120 l/min	235 mm	40008L

## Saw blade for bodywork

for use with the pneumatic bodywork saw 40008L as well as models from Pneutec, Ober, CP etc.

- bi-metal



Description	Part no.
18 Teeth, 1.4 Pitch - Plastics / aluminium	70618L
24 Teeth, 1.0 Pitch - Plastics / aluminium	70624L
32 Teeth, 0.7 Pitch - Plastics / aluminium	70632L

## Chassis saw blade

for use with compressed air chassis jigsaws, e.g. SIG, Flex,

- Bimetal



Description	Part no.
18 Teeth, 1.4 Pitch - Plastics / aluminium	70718L
24 Teeth, 1.0 Pitch - Steel / iron sheets	70724L
32 Teeth, 0.7 Pitch - Steel / iron sheets	70732L

## Sheet shears

lever transmission, industrial quality, toothed, inductively hardened cutting edges



Description	Length	Part no.
Right-hand cut	260 mm	92710L
Left-hand cut	260 mm	92720L

## Pipe and hose cutter

for separating plastic pipes made of polypropylene and polyethylene, with lever transmission for pipes from 5 - 40 mm diameter



Part no.  
**S1902**

## Pneumatic spot weld cutter



with removable clamp for spots that are difficult to access and automatic drill advance, cutting depth can be adjusted infinitely on the ring in steps of 0.05 mm. This means the second sheet is not drilled through, and reworking is not necessary.

Higher durability of the drill is possible if insertion is carried out centered.

Air nipple, angle piece, automatic oiler for daily grease, as well as HSSCo milling drills (3 x 8.0 and 2 x 6.5 mm) are included.



Speed	Working pressure min./max.	Air consumption	Part no.
1600 rpm	6,3 bar	220 l/min	40020L

## Weld spot drill



for pneumatic weld spot drills Vario, HSS-E, TITANIUM nitrified

① For pneumatic machines



D	Length	Part no.
8 mm	44 mm	82588L

## Weld spot drill



HSS, regrindable



D	Length	Part no.
6 mm	66 mm	82560L
7 mm	74 mm	82570L
8 mm	79 mm	82580L

## Weld spot drill



HSS-E, TITANIUM nitrified - ca. 5 times the tool life, regrindable



D	Length	Part no.
8 mm	79 mm	82591L

## Weld spot cutter set



Packed in a box, for drilling out all weld spots.

- 2 complete drills
- 4 replacement cutters
- 2 centring tips
- 1 allen key

Suitable for 6 mm and 8 mm weld spots.



Description	Part no.
9-piece	82510L



## Weld spot cutter

HSS YYY

with exchangeable cutter, HSS



Description	Part no.
Complete cutter	82500L
Replacement cutter	82501L

## Hardmetal burrs

YYY

Hardmetal burrs as per DIN8033

- for deflashing, chamfer edges, weld seam and surface machining
- staggered teeth joint for great removal of material on cast iron, steel and stainless steel
- shaft diameter 6 mm

Contents:

- 1x form B – cylindrical with end-face serration toothing
- 1x form D – ball shape
- 1x form G – pointed arch shape



Description	Part no.
3-piece	82550L

## Range of thread and tap drills, M4 – M10

HSS YYY

very handy combination range for drilling, cutting and counterboring the most common standard metric threads.

Contents:

- tap twist drill HSS-G DIN338:  $\varnothing$  3.3 mm,  $\varnothing$  4.2 mm,  $\varnothing$  5.0 mm,  $\varnothing$  6.8 mm,  $\varnothing$  8.5 mm
- thread tap form B DIN371 HSS-E (Co5): M4x0.7, M5x0.8, M6x1.0, M8x1.25, M10x1.5
- countersink 90° HSS DIN335C HSS,  $\varnothing$  10.4 mm,  $\varnothing$  16.5 mm
- handy plastic box with threaded cover.



Description	Part no.
12-piece	82229L

## Hole cutter

HSS YYY

HSS in industrial quality



Description	Part no.
8 - 20 mm	82401L
5 - 31 mm	82404L
16 - 30 mm	82402L
24 - 40 mm	82403L

## Twist drill set

HSS 



HSS, TITANIUM nitrified for extremely long tool life.

- 4 - 12 mm (4, 5, 6, 7, 8, 9, 10, 11, 12 mm)
- 4 - 20 mm (4, 6, 8, 10, 12, 14, 16, 18, 20 mm)
- 4 - 30 mm (4, 6, 8, 10, 12, 14, 16, 18, 20, 22, 24, 26, 28, 30 mm)



**Description**  
3-piece

**Part no.**  
82415L

## Twist drill

HSS 

HSS, titanium nitrified for optimum tool life, industrial quality, drilling steps increasing in steps of 2 mm



**Description**  
4 - 22 mm  
4 - 32 mm

**Part no.**  
82411SB  
82412SB

## Twist drill set

HSS 

HSS nitride coated, right-handed thread, high cutting capacity and feed thanks to spiral groove shape.

- 4, 5, 6, 7, 8, 9, 10, 11, 12 mm
- 4, 6, 8, 10, 12, 14, 16, 18, 20 mm
- 6, 8, 10, 12, 14, 16, 18, 20, 22, 24, 26, 28, 30 mm



**Description**  
3-piece  
6-30 mm,

6, 8, 10, 12, 14, 16, 18, 20, 22, 24, 26, 28, 30

**Part no.**  
82416L  
82417L

## Twist drill

HSS 

HSS nitride coated, right-handed thread, high cutting capacity and feed thanks to spiral groove shape.



**Description**  
6-30 mm,

6, 8, 10, 12, 14, 16, 18, 20, 22, 24, 26, 28, 30

**Part no.**  
82417L





## Step drill

DIN HSS YYY

HSS, right-handed thread with crosswise grinding  
Ideal for metric cable glands according to DIN/EN 50262

- for sheet steel and stainless steel, max. 2 mm thickness
- for non-metals max. 5 mm thickness
- with 11 stages
- 10 mm drive for drill



Description	Part no.
6,5 - 40,5 mm	82418L

## Hole saw

HSS YYY

HSS tooth cutting edges welded onto body made of special steel, with variable tooth pitches for low vibration and even cut, low heat development. Suitable for sheet metal, light alloys, plasterboard, plastic, wood etc., ideal for installation work on booster heating, air-conditioning systems etc.

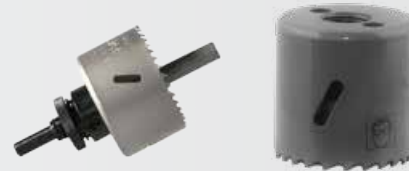

① without clamping mandrel

Description	D	Part no.
Hole saw	19 mm	82450L-19
Hole saw	22 mm	82450L-22
Hole saw	29 mm	82450L-29
Hole saw	35 mm	82450L-35
Hole saw	38 mm	82450L-38
Hole saw	44 mm	82450L-44
Hole saw	51 mm	82450L-51
Hole saw	57 mm	82450L-57
Hole saw	65 mm	82450L-65
Hole saw	68 mm	82450L-68
Clamping mandrel for crowns up to 30 mm in diameter	9,5 mm	82451L
Clamping mandrel for crowns from 35 mm in diameter	11 mm	82452L

## Blind rivet pliers

YYY

for aluminium work, with replaceable nosepieces

2.4 - 3.0 - 4.0 - 4.8 mm



Length	Part no.
250 mm	42700L

## Professional blind rivet pliers

YYY

profi version, for aluminium rivets, with replaceable nosepieces

2,4 - 3,0 - 4,0 - 4,8 mm



Length	Part no.
250 mm	42710L



## Blind rivet pliers

head can be turned through 360°, for aluminium rivets, with 4 replaceable nosepieces

2.4 - 3.0 - 4.0 - 4.8 mm



**Length**

250 mm

**Part no.**

**42750L**

## Blind rivet pliers set

box with pliers and 100 different blind rivets

- with four replaceable heads
- for blind rivets 2.4 - 3.0 - 4.0 - 4.8 mm
- incl. 100 blind rivets (25 per size)



**Length**

250 mm

**Part no.**

**42800L**

## Shear rivet tool

for aluminium and steel rivets and rivet nuts, with many accessories, an absolute must for working on riveted window lifters

- pads 3.2 - 4.0 - 4.8 - 5.0 - 6.4 mm
- rivet nuts M4 - 5 - 6 - 8 - 10
- handles can be unfolded to 500 mm
- little force required



**Length**

500 mm

**Part no.**

**42760L**

## Special locking pliers

with quick release

- for welding and clamping work on door openings, wheel arches, side walls, sheets with bending properties etc.
- for use in the whole body
- as a fitting aid on doors, wheel arches and many other spots



**Length**

195 mm

**Part no.**

**41545L**

## Automatic gripping pliers

with quick-action adjustment

- can be used without any pre-adjustment
- infinite adjustment of the clamping force independent of the workpiece
- simple and injury-free release
- high-strength version



ⓘ **One-handed operation possible!**

**Length**

150 mm

250 mm

**Part no.**

**41551L**

**41552L**





## Locking pliers

with forged jaws, with wire cutter



Length

250 mm

Part no.

41500L

## Locking pliers, Extra short

mini, universal version, semi-circular jaws, chrome-plated, 6 rivets



Length

100 mm

Part no.

41501L

## Locking pliers

Special steel, 3-fold adjustment, can be clamped up to 55 mm



Length

250 mm

Part no.

41505L

## Langbeck Locking pliers

with extremely narrow bit for spots that are difficult to access



Length

170 mm

Part no.

41520L

225 mm

41521L

## Spot welding locking pliers

forged

side length: 80 mm  
max opening width: 80 mm



Total length

270 mm

460 mm

Part no.

41515L

41516L

## Gripping pliers set

with non-slip handles

- 2 universal-gripping pliers, 130 mm
- 3 universal-gripping pliers, 180 mm
- 5 universal-gripping pliers, 225 mm
- 1 langbeck locking pliers, 160 mm
- 1 langbeck locking pliers, 225 mm
- 2 spot welding locking pliers, 280 mm
- 2 welder's locking pliers, 225 mm



Description

16-piece

Part no.

41560L



# ELECTRICS





# ELECTRICS

604-621



- ▶ Diagnosis and Testing Units 606-610
- ▶ Battery Service and Charger 610-614
- ▶ Wire Stripper and Electronic Pliers 614-618
- ▶ Needle and Hook Sets 618-620





## Digital multimeter



with LCD display, inc. 2 x AAA battery

- DC voltage 200 mV - 600 V
- AC voltage 200 V - 600 V
- direct current 10 A
- resistance 200 - 2000 kOhm

Ceramic fuse included: length 20 mm, diameter 5 mm, 600V, 250mA

Ceramic fuse included: length 20 mm, diameter 5 mm, 600V, 10A



Description	Part no.
Multimeter	32220L
Replacement testing tips, 1 pair	32221L

## Digital-Multimeter



Compact and handy, high-contrast, one-line LCD display, 19-position rotary switch.

The automatic overflow and polarity display provides a reliable warning which helps avoid faults. A temperature sensor allows to measure temperatures between -20°C and +120°C.

- set up
- "Hold"-key
- measuring cable with touch protection
- DC: 200 mV - 500 V
- AC: 200 V - 500 V
- DC: 200mA - 10 A
- resistance: 200 - 2000 Ohm
- diode tester
- max. display: 1999
- 9V battery (in the device)

Ceramic fuse included: 20 mm, 5 mm diameter, 500 V, 500 mA

Ceramic fuse included: 20 mm, 5 mm diameter, 500 V, 10 A



Description	Part no.
Multimeter	32230L
Replacement testing tips, 1 pair	32231L

## Digital multimeter



acoustic transition tester, transistor test, capacity and frequency measurement, data retaining function, automatic range selection.

- DC voltage up to 600 V
- AC voltage up to 600 V
- Direct current up to 10 A
- Alternating current up to 10 A
- Resistance up to 40 MOhm
- Capacity up to 40 mF
- Frequency: 10 Hz - 10 MHz
- 9 V battery

Ceramic fuse included: length 20 mm, diameter 5 mm, 500mA, 600V

Ceramic fuse included: length 20 mm, diameter 5 mm, 10A, 600V



Description	Part no.
Multimeter	32235L
Replacement testing tips, 1 pair	32231L

## Digital Clamp Multimeters



Round device with the following measurement ranges:

- AC Current 2000 mA, 20A, 600 A
- AC Voltage: 200 V, 600 V
- DC Voltage: 200 V, 600 V
- resistance 200 Ohm, 200 kOhm
- acoustic continuity tester
- includes test leads and battery



Part no.  
32222L

## Multitester



for passenger cars and trucks, for testing the on-board electric systems 6 - 24 Volt, different special applications are possible:

- thermo switch testing
- wiper motor or petrol pump testing in fitted condition
- trailer coupling testing
- suitable as diode test device



ⓘ Testing of trailer power supply possible

Measuring range: voltage AC/DC  
6 - 24 V

Part no.  
32255L

## Fuse ammeter



for the fast measurement of direct current on trucks, passenger cars and motorbikes via the contact of standard plug-in fuses (ATO fuses), also has an adapter for mini fuses. Ideal for determining closed circuit current consumers.

- 0.1 to 19.9 A
- with LCD display
- LED lighting
- 20 A inherent fuse protection
- including button battery (CR2032)



ⓘ Note: Not suitable for diagnosing short-circuits and measurements over 20A!

Part no.  
32224L





## Measuring cable set



an ideal addition to 32220L / 32230L and 32235L circuit analysers. The set includes a pre-manufactured test cable, 190 mm long, in yellow, red, black and blue with different connections such as:

- in each set 3 pcs. blade terminal, flat sleeve, round plug, round sleeve, point cable plug, point cable sleeve
- 2 x connection cable set 1,000 mm (red / black) – enables elongation to 2,000 mm in total
- 2 crocodile clips (red / black) with a jaw opening of up to 25 mm
- 1 set of testing tips - red / black - (in connection with a connection cable)
- 2 sets of testing needles, 220 mm cable length, red / black – for plugging into the cable to be tested
- (together with a connection cable)
- 2 pcs. 2-colour-LED-test cable for determining the polarity (together with testing tips/needles or crocodile clips – with the correct polarity, the LED lights up green and with the wrong polarity, red)
- 2 test resistances 0.25 A (yellow) for the SRS airbag and belt tightening systems
- 2 bridge plugs '2 in 1' (black)
- 2 potentiometers 5K ohm (infinitely adjustable)



**Description**

92-piece

**Part no.**

**32225L**

## Measuring cable set



ideal accessory for our multimeters 32220L / 32230L and 32235L.

The set includes:

- 2 sets of connecting cables 1,000 mm (red/black) - to extend to 2,000 mm in total,
- 2 crocodile clips (red/black) with jaws up to 25 mm,
- 1 set of probes - red/black - (with connecting cables)
- 2 sets of test needles - red/black - to pierce the cable for testing (with connecting cables)
- 2 pcs 2-tone LED test cable to determine polarity (together with the probes / test needles or crocodile clips: the LED is green if the polarity is correct and red if the polarity is incorrect)
- 1 pc Injection clip probe (rotatable) with autom. needle to pierce the insulation



**Description**

15-piece

**Part no.**

**32226L**

## Test cable socket



190 mm cable length



**Description**

- 3 x 5 mm cable socket, for plug 0,8 x 2,8 mm, red
- 3,3 x 3,3 mm cable socket, for plug 0,6 x 2,3 mm, yellow
- 2,5 x 3,6 mm cable socket, for plug 0,6 x 1,9 mm, blue
- 2,5 x 3 mm cable socket, for plug 0,6 x 1,3 mm, black
- 2,5 x 2,6 mm cable socket, for plug 0,6 x 0,9 mm, red
- 2,3 x 2,3 mm cable socket, for plug 0,6 x 0,6 mm, yellow

**Part no.**

- 32225L-1**
- 32225L-2**
- 32225L-3**
- 32225L-4**
- 32225L-5**
- 32225L-6**



## Test cable connector



190 mm Cable length.



Description	Part no.
0,8 x 2,8 mm probe tip, red	32225L-7
0,6 x 2,3 mm probe tip, yellow	32225L-8
0,6 x 1,9 mm probe tip, blue	32225L-9
0,6 x 1,3 mm probe tip, black	32225L-10
0,6 x 0,9 mm probe tip, red	32225L-11
0,6 x 0,6 mm probe tip, yellow	32225L-12

## Probe



220 mm cable length



Description	Part no.
0,7 mm diameter, black	32225L-13
0,7 mm diameter, red	32225L-14

## Connecting cable



for multimeters, etc.  
from the sets 32225L and 32226L



Description	Part no.
1.000 mm Cable length, black	32225L-15
1.000 mm Cable length, red	32225L-16

## Puncture probe set



with individually adjustable puncture depth for cable diameters up to 4 mm. No annoying cable slippage thanks to the rotate function to adjust the depth.

- 1 red and 1 black clip each



Part no.  
32228L

## Voltage tester



Universal, 2-pole,

- for AC voltage 12 - 400 V
- DC voltage 12 - 500 V
- 5-stage LED polarity display
- (12V, 50V, 120-150V, 220-230V, 400-500V)



Part no.  
32215SB

## Polarity tester



with LED display for + / - and puncturing function for isolated lines, 3 - 48 volts, to prevent damage caused by incorrectly polarized lines



Voltage	Part no.
3 - 48 V	31705SB





## Testing lamp

Brass, nickel-plated  
6 - 12V



Description	Voltage	Length	Part no.
Testing lamp	6-12 V	110 mm	32200L
Spare tubular bulb		34 mm	32201L

## Voltage tester

with clip



Voltage	Length	Part no.
250 V	140 mm	31701SB
250 V	190 mm	31702SB

# Battery Service and Charger

## Battery acid tester

with float



Part no.  
21510L

## Refractometer

for testing battery acid density from 1.1 - 1.4 kg/l and antifreeze coolant from 0° / -50 °C as well as windscreen washing fluid from 0° / -40 °C



- adjustable ocular
- settable calibration fixture
- measuring accuracy +/- 5%

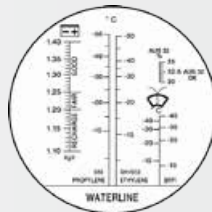

Used as VAG OEM T10007 A

ⓘ Also suitable for checking the correct mixing ratios for AdBlue® (AUS 32) additives and windshield cleaner based on alcohol (SRF1) and ethanol.

Description	Part no.
Complete in case	21550L
Replacement glass	21550L-1
Pipette	21550L-2

## Battery / charging system tester

with printer and 30 m standard paper roll



- suitable for 6V+12V, DIN-SAE-EN, lead/acid-gel-AGM-SLA batteries
- Option to test the generator 12V/24V
- LCD display + integrated thermal printer
- Date and time function
- incl. carrier bag
- Cable length 1.8 m
- Operating range SAE 40 - 2000 A, EN 40 - 2100 A, DIN 25 - 1300 A, IEC 30 - 1500 A, JIS by battery type no.



Description	Part no.
Battery / charging system tester	32280L
1 replacement roll	32281L

## Battery tester



to quickly test the condition of car batteries

suitable for 12-V batteries

- permit a 10-secondes-last-test with 100 Amp > 10 seconds automatic power off
- direct capacity-display on 3-digit LED-display
- max. Battery capacity CCA from 200 to 1000
- 3-stage display off the battery status green (all right) yellow (weak) red (substitute)
- charging system test by switching on the consumer is possible while the engine is running



① Improved version with automatic test sequence!

Part no.  
34035L

## Battery charger



Fully automatic process-controlled charger, especially suitable for motorbike and scooter batteries from 1.2 Ah to 20 Ah.

The straightforward charging is carried out via a plug-type charger: Just connect, then charge directly in the socket – that's it!

- Maintenance charge + permanent charge function

Delivery:

Charge Box 0.8 with adapter cable (pole clamps, lugs, cigarette lighter) and pocket.



Charging current	Battery capacity	Charging voltage	Part no.
0,8 A	1,2 - 20 Ah	12 / 14,4 V	34008L

## Battery charger



Fully automatic process-controlled charger for no less than three different charging modes: motorbike, car and high (AGM + GEL) batteries – only one charger for three battery types!

Simple mode change by pressing the "MODE" button. For battery types from 1.2 Ah to 120 Ah. Even batteries that have been completely discharged can be charged again.

- pulse charge + maintenance charge + permanent charging function

Delivery: Charge Box 3.6 with adapter cable (pole clamps, lugs, cigarette lighter) and pocket.



Charging current	Battery capacity	Charging voltage	Part no.
0,8 / 3,6 A	1,2 - 120 Ah	12 / 14,4 / 14,7 V	34036L

## Battery charger



Fully automatic process-controlled charger, especially suitable for mobile homes, buses, agricultural machinery, boats and rehabilitation vehicles for capacities from 14 Ah to 230 Ah and from 14 Ah to 120 Ah. The Charge Box 7.0 can be switched from 12 V to 24 V.

- Pulse charge + maintenance charge + permanent charging function

Delivery:

Charge Box 7.0 with adapter cable (pole clamps, lugs, cigarette lighter) and pocket.



Charging current	Battery capacity	Charging voltage	Part no.
7 / 5 / 3,5 / 1,5 A	12V 14 bis 230 / 24V 14 bis 120 Ah	14,4 / 14,7 / 28,8 / 29,4 V	34070L





## Adapter cable

for connecting to the positive and negative terminal of a battery. The current connection for loading of a battery.



Part no.  
34500L

## Adapter cable

ideal for conservation charging of vintage cars, seasonal cars and motorbikes. It is possible to connect the 6 mm ring cable sockets to the battery permanently.



Description  
Cable sockets

Part no.  
34510L

## Adapter cable

ideal for loading the battery via cigarette lighter. Especially useful for car batteries which are difficult to access.

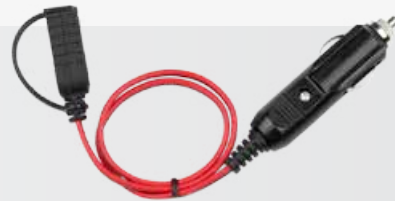

⚠ Only for cigarette lighter with permanent current!

Description  
Cigarette lighter

Part no.  
34520L

## Adapter cable pole

for loading via 12V connection of BMW motorbikes.



BMW

Description  
12V DIN

Part no.  
34521L

## Battery charger



Fully automatic processor-controlled charging computer with LCD display. For all 12 and 24 V lead-acid batteries (wet, gel, AGM).

- Mains voltage 120 - 240 V ~ 50 / 60 Hz
- Possible charging current 12V / 24V – 5A or 10A
- Inverse polarity and overheating protection, without sparking
- Digital display of current voltage (Volt = V) and charging current (Ampere = I)
- Ideal for maintenance charge (e.g. during programming or fault queries), permanent charge and pulse charge
- Incl. two permanently connected terminal clamps



Charging current  
12V / 24V - 5A / 10A

Charging voltage  
12 / 24 V

Part no.  
34100L

## Pole terminal remover

for universal use for pole terminals and wiper arms on many passenger cars and trucks.

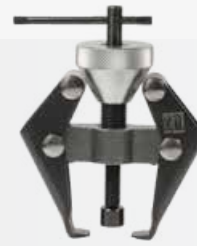

ⓘ The remover cannot spread due to the conical nut

Description  
Double-arm

Part no.  
10124L

## Battery brush

for brushing off corrosion and dirt on battery poles and pole terminals



ⓘ Suitable for interior and exterior cleaning!

Part no.  
34005L

## Battery pole terminal cleaning milling cross

with conical milling cutter and scraper to eliminate plus and minus pole corrosion.



Part no.  
34015SB

## Battery service key

for inserting and removing the acid stopper without damage and where space is tight



Part no.  
34000L

## Funnel set

made of plastic

- Diameter 50, 75, 100, 125 mm



Description  
4-piece

Part no.  
07378L

## Battery carrier

for the straightforward transport and fitting of car batteries, size can be adjusted



Part no.  
34020L





## Jumper cable

with sturdy insulated clamps



Description	Part no.
Ø 12 mm / 25 mm <sup>2</sup> , 350 ampere, 3,5 m	S9611

## Jumper cable

with sturdy insulated clamps



Description	Part no.
Ø 13 mm / 35 mm <sup>2</sup> , 480 ampere, 3,5 m	S9612

## Overvoltage protection

prevents dangerous overvoltage during welding work

- maximum load 200 A
- copper cable and steel clamps with rubber protection
- length of the cable: 195 mm
- up to 12 volts



Part no.  
32250L

# Wire Stripper and Electronic Pliers

## Cable lug gripper

- especially for insulated ties 1.5 - 2.5 - 6.0 mm
- stripping: 0.75 - 1.0 - 1.5 - 2.5 - 4.0 - 6.0 mm
- screw cutter M2.6 - M3 - M3.5 - M4 - M5



Part no.  
42500L

## Cable lug gripper

- especially for non-insulated ties 1.5 - 2.5 - 6.0 mm
- stripping: 0.75 - 1.0 - 1.5 - 2.5 - 4.0 - 6.0 mm
- screw cutter M2.6 - M3 - M3.5 - M4 - M5



Part no.  
42501L

## Cable lug gripper

- for **insulated and non-insulated** ties 1.5 - 2.5 - 6.0 mm
- stripping: 0.75 - 1.0 - 1.5 - 2.5 - 4.0 - 6.0 mm
- screw cutter M2.6 - M3 - M3.5 - M4 - M5



Part no.  
42504L

## Cable lug gripper

professional - with leverage and forced lock



Description	Part no.
For insulated ties 0,5 - 6 mm <sup>2</sup>	<b>42550SB</b>
For non-insulated ties 0,5 - 6 mm <sup>2</sup>	<b>42565SB</b>
Pair of spare jaws for 42565L	<b>42566L</b>

## Cable lug gripper

with replaceable mouthpieces, forced lock, 2-K insulated handle, in plastic box

- jaw A: for insulated cable lugs from 0.5 - 6.0 mm<sup>2</sup> (red, blue, yellow)
- jaw B: for closed, non-insulated cable lugs from 0.5 - 10.0 mm
- jaw C: for open, non-insulated cable lugs from 0.5 - 6.0 mm, up to 6.3 mm width
- jaw D: for cable end sleeves with and without collar from 0.5 - 4.0 mm
- jaw F: for cable end sleeves over 4.0 mm



Description	Part no.
Complete set, 6-piece	<b>42585L</b>
Pair of replacement jaws A	<b>42585L-A</b>
Pair of replacement jaws B	<b>42585L-B</b>
Pair of replacement jaws C	<b>42585L-C</b>
Pair of replacement jaws D	<b>42585L-D</b>
Pair of replacement jaws F	<b>42585L-F</b>

## Pair of spare cheeks

for cable lug clamping tongs 42585L

- jaw H: for crimp connectors with cable cross-section 0.5 mm<sup>2</sup> / 2.5 mm<sup>2</sup> / 8-10 mm<sup>2</sup> e.g. for Japanese motorcycles (Honda, Kawasaki, Yamaha, etc.)



Description	Part no.
Pair of replacement jaws H	<b>42585L-H</b>

## Pair of spare cheeks

for cable lug gripper 42585L

- jaw E: for BNC/TNC coaxial plug RG58, RG59, RG62 with hexagonal fit



Description	Part no.
Pair of replacement jaws E	<b>42585L-E</b>



## Cable lug gripper



with replaceable jaws for insulated and non-insulated connectors.

This set contains a comprehensive assortment of connectors in a secure and well-arranged transport box. The innovative pliers make it easy to replace the enclosed clamping jaws.

- for insulated cable lugs from 0.5 - 6.0 mm<sup>2</sup> (red, blue, yellow)
- for non-insulated cable lugs 1.5 - 10 mm<sup>2</sup> with mandrel press-fit
- complete with 1000 different cable lugs



Part no.  
42590L

## Cable lug gripper



for cable end sleeves, forged, with spring and handle protection

for sleeves 0.5 - 0.75 - 1.0 - 1.5 - 2.5 mm<sup>2</sup>



Length  
150 mm

Part no.  
42520L

## Cable stripping tongs



self-adjusting for cables 0.2-6 mm<sup>2</sup>

- with adjustable length stop for insulation stripping 8-12 mm
- cable cutter up to 2 mm diameter
- determination for space-efficient retention and care of the cutting blades

ⓘ self-adjusting!



Part no.  
42420L

## Stripping pliers



self-adjusting 0.2 - 6 mm<sup>2</sup>, with wire cutter

- ideal for doubly insulated cables
- separates insulation in the middle of a cable too, to solder branches
- for pressing insulated or non-insulated cable lugs and ignition plugs

ⓘ Self-adjusting!

Length  
210 mm

Part no.  
42410SB



## Electronics side-cutting pliers



### Racing Experience

- with oval head
- 2-component soft-grip ESD handle sleeve grey/black
- drop-forged, made of high-quality tool steel with bevel
- sturdy and durable for hard and soft wires



Length  
125 mm

Part no.  
40590L



## Electronics taper tap



### Racing Experience

- with wide head and long cutting edges
- with 2-component soft-grip ESD handle sleeve grey/black
- drop-forged, made of high-quality tool steel with fine bevel
- sturdy and durable for hard and soft wires



Length  
125 mm

Part no.  
40591L

## Electronics long-nosed pliers



### Racing Experience

- short jaws
- with 2-component soft-grip ESD handle sleeve grey/black
- drop-forged, made of high-quality tool steel without blow to protect components and wires
- sturdy and durable



Description	Length	Part no.
Straight version	130 mm	40790L
Bent version 45°	130 mm	40791L

## Precision mechanic's tool set



in case

- universal pliers 120 mm
- side-cutting pliers 115 mm
- long-nosed pliers bent 125 mm
- long-nosed pliers straight 130 mm
- 3 electronic plain slot screwdrivers 2 - 2.5 - 3 x 50 mm
- 3 electronic cross-slot screwdrivers sizes 00 - 0 - 1 x 50 mm



Description	Part no.
10-piece	40706L

## Electro soldering gun



with VDE plug, 100 Watt, 220V, with work light



Description	Part no.
Soldering gun	62000SB
Replacement soldering tip (2-piece)	62001SB

## Soldering iron



for battery-operated use, ready for use in only about 15 seconds, for the fast and mobile repair of cold solder spots etc. 4.5 V / 6 W, working temperature approx. 420°C. With 3 AA batteries (not included in the scope of supply) up to 120 solder spots possible, can also be used with rechargeable batteries. The working area is optimally illuminated by an LED. The set includes a protective cap, lead-free solder, soldering tip with removal key.  
>Shaft 3 mm / tip 0.7 mm diameter



ⓘ Without batteries!

Part no.  
61805SB





## Solder fixing pliers



for support during cable soldering. The cable ends to be soldered are stripped, clamped to the pliers faces and aligned to one another - avoiding a kink in the solder connection.

The pliers can be tightened, allowing them to be set down and leaving both hands free for soldering.



Part no.  
42415L

## Soldering grease



according to DIN EN 29454-1, for soft soldering and tin-plating



Description

Part no.

50 g

62050L

250 g

62052L

## Soldering wire



- HS10 on coil, 2 mm diameter
- 40 % SN, 60 % PB
- flux-cored



Description

Part no.

100 g

62010L

250 g

62011L

500 g

62012L

# Needle and Hook Sets

## System cable unlocking set



Universal range for virtually all vehicles, for damage-free unlocking of electrical plugs and connectors, e.g. for ABS, climate sensors, radio, PDC, trailer coupling module, and much more.

Faults due to corrosion or connection defects can be quickly found.

- suitable for round and tab contacts
- indispensable for mechatronics technicians and vehicle electricians



BMW  
Audi  
Opel  
Chrysler  
Citroën  
Fiat  
Ford  
Honda  
Jaguar  
Mazda  
Mercedes-Benz  
Mitsubishi  
Porsche  
Renault  
Saab  
Seat  
Škoda  
Toyota  
VW

Description

Part no.

23-piece for systems of common vehicle manufacturer

32160L

## Unlocking tool set

for the removal of different contact systems (ABS, air-conditioning, sensors...). The professional use prevents damage to housing or contact.

- Suitable for round and blade-type contacts
- Protective cap over the tool tip prevents damage to the blade when not in use
- Suitable for many vehicle types e.g. VW, Opel, Ford, Mercedes-Benz, BMW, etc.
- 1 unlocking tool each for:
  - Round plug contacts Ø 1.5 mm
  - Round plug contacts Ø 2.3 mm
  - Round plug contacts Ø 3.5 mm
  - Blade-type contacts standard 1.48 mm
  - Blade-type contacts Micro-Timer 1
  - Blade-type contacts Micro-Timer 2+3
  - Blade-type contacts Maxi-Power-Timer
  - Blade-type contacts PIT POD
  - Blade-type contacts JPT/SPT
  - 3 replacement inserts



**BMW**  
**Ford**  
**Mercedes-Benz**  
**Opel**  
**VW**



Description	Part no.
Universal use, 9-piece	<b>32100L</b>
Special set for VAG/Porsche, 11-piece	<b>32120L</b>
Special set for MAN / Volvo, 14-piece	<b>32150L</b>
Replacement sleeves from 32100L	<b>32100L-1</b>
CE01, individual tool Ø 1,5 mm	<b>32100L-CE01</b>
CE02, individual tool Ø 3,5 mm	<b>32100L-CE02</b>
CE05, individual tool Ø 2,3 mm	<b>32100L-CE05</b>
CE53, with one release point 2,8 / 5,8 mm	<b>32100L-CE53</b>
CE56, individual tool II/III	<b>32100L-CE56</b>
CE91, with two release point 2,8 / 5,8 mm.	<b>32100L-CE91</b>

## Needle and hook set

for Mercedes-Benz

- Ignition locks of the series W123, W124, W126, W201
- Instrument cluster of the series W116, W123, W124, W126, W140 and W201

and dashboards from other manufacturers



**Mercedes-Benz**

Description	Part no.
6-piece	<b>10655L</b>
T-formed hook set, 2-piece	<b>10655L-T</b>

## Needle and hook set

for removing and installing radios and navigation displays, for almost all vehicle and unit manufacturers



**Audi**  
**BMW**  
**Mercedes-Benz**  
**Opel**  
**Porsche**  
**VW**

Description	Part no.
18-piece	<b>10650L</b>



## Needle and hook set

for removing and installing radios, instrument clusters and navigation displays for almost all vehicle and device manufacturers, in a clearly organised box

- 4x P-01 - Mercedes-Benz, VW, Audi, Becker
- 2x P-02 - Mercedes-Benz, Porsche, Becker
- 2x P-03 - VW
- 2x P-04 - Škoda
- 2x P-05 - Becker
- 2x P-06 - Clarion
- 2x P-07 - PK Clarion
- 2x P-08 - RK-Kenwood 01
- 2x P-09 - Sony
- 2x P-10 - RK-Kenwood
- 2x P-11 - Fiat Bravo, Brava
- 1x screwdriver - BMW
- 1x Allen key - BMW, Opel
- 1 set of hooks - Opel, Grundig, Blaupunkt
- 1 set of hooks - VW, Audi, Ford
- 1 set of hooks - Blaupunkt



Audi  
BMW  
Mercedes-Benz  
Opel  
Porsche  
VW  
Seat  
Škoda

**Description**

32-piece

**Part no.**

**10660L**





# TOOL TROLLEY / FOAM INSERTS





# TOOL TROLLEY / FOAM INSERTS

**622-665**



- ▶ Tool Trolleys 624-626
- ▶ Tool Trolleys with Tool Foam Inserts 627-632
- ▶ 3/3 Tool Foam Inserts 632-641
- ▶ 2/3 Tool Foam Inserts 641-642
- ▶ 1/3 Tool Foam Inserts 643-653
- ▶ Accessories 653-656
- ▶ Tool Assortments 657
- ▶ 1/1 Tool Foam Inserts Kompakt 657-658
- ▶ 2/3 Tool Foam Inserts Kompakt 659-660
- ▶ 1/2 Tool Foam Inserts Kompakt 661
- ▶ 1/3 Tool Foam Inserts Kompakt 662-664
- ▶ 1/4 Tool Foam Inserts Kompakt 664-665



## Workshop mobile tool chest - RX-Edition

Workshop mobile tool chest - **Racing Experience** with 8 drawers

- drawers full extension, ball bearing
- quick lock on each drawer
- central lockable
- multiple extraction possible
- additional folding storage
- plastic edge protection
- side insertion possibility for screwdriver
- 2 swivel castors
- 2 wheels on the outside

### Drawer interior dimensions

Width: 570 mm  
 Depth: 410 mm  
 Height 1. - 7. Drawer: 74.5 mm  
 Height 8. Drawer: 153.5 mm

### Drawer load

Top cover 55 kg  
 Top 7 drawers 25 kg  
 Lower 8. drawer 30 kg  
 Total 260 kg



Description	Length	Width	Height	Part no.
black / silver	800 mm	482 mm	1013 mm	<b>07080L</b>
document holder				<b>07081L</b>
Paper holder				<b>07082L</b>
Multiplex insert plate				<b>07083L</b>

## Workshop mobile tool chest XL - RX-Edition



Workshop mobile tool chest **XL - Racing Experience** with 8 drawers

- drawers full extension, ball bearing
- quick-release latching system for each drawer
- central lockable
- multiple extraction possible
- stainless steel cover (load 50 kg) with side compartments
- incl. external waste container and spray can holder
- 2 swivle castors
- 2 wheels on the outside

### Drawer interior dimension

Width: 815 mm  
 Depth: 395 mm  
 Height 1. - 7. drawer: 70 mm  
 Height 8. drawer: 135 mm

### Drawer Load

Top cover 50 kg  
 Top 7 drawers 30 kg  
 Lower 8. drawer 35 kg  
 Total 295 kg



Description	Length	Width	Height	Part no.
black / silver	1020 mm	530 mm	990 mm	<b>07091L</b>
document holder				<b>07081L</b>
Paper holder				<b>07082L</b>



## Workshop mobile tool chest XXL - RX-Edition



Workshop mobile tool chest **XXL - Racing Experience** with 7 drawers and store cabinet

- drawers full extension, ball bearing
- quick-release latching system for each drawer
- central lockable
- multiple extraction possible
- stainless steel cover with side compartments
- incl. external waste container and spray can holder
- with store cabinet
- 2 swivle castors
- 2 wheels on the outside

### Drawer interior dimension

Width 1. drawer: 950 mm  
 Depth 1. drawer: 395mm  
 Width 2. - 7. drawer: 570 mm  
 Depth 2. - 7. drawer: 395 mm  
 Height 1. drawer: 100 mm  
 Height 2. - 6. drawer: 70 mm  
 Height 7. drawer: 135 mm

### Drawer Load

Top cover 50 kg  
 Store cabinet 30 kg  
 Top 1. drawers 40 kg  
 Top 2. - 6. drawers 25 kg  
 Lower 7. drawer 30 kg  
 Total 275 kg



Description	Length	Width	Height	Part no.
black / silver	1150 mm	480 mm	1010	<b>07092L</b>
Document holder				<b>07081L</b>
Paper holder				<b>07082L</b>

## Workshop mobile tool chest - RX-Edition



Workshop mobile tool chest with 7 drawers

- drawers full extension, ball bearing
- quick lock on each drawer
  - central lockable
  - multiple extraction possible
  - plastic edge protection
  - 2 swivel castors

### Drawer interior dimension

Width: 545 mm  
 Depth: 395 mm  
 Height 1. - 5. drawer: 70 mm  
 Height 6. - 7. drawer: 125 mm



Description	Length	Width	Height	Part no.
black / silver	775 mm	460 mm	970 mm	<b>07050L</b>

## Workshop mobile tool chest - RX-Edition

Workshop mobile tool chest - **Racing Experience** with 7 drawers

- drawers full extension, ball bearing
- quick lock on each drawer
- central lockable
- multiple extraction possible
- additional folding storage
- plastic edge protection
- side insertion possibility for screwdriver
- 2 swivel castors
- 2 wheels on the outside

### Drawer interior dimension

Width: 570 mm  
 Depth: 410 mm  
 Height 1. - 2. drawer: 59 mm  
 Height 3. - 6. drawer: 75 mm  
 Height 7. drawer: 187 mm

### Drawer Load

Top cover 30 kg  
 Top 6 drawers 25 kg  
 Lower 7. drawer 30 kg  
 Total 210 kg



Description	Length	Width	Height	Part no.
black / silver	724 mm	470 mm	910 mm	07065L

## Workshop mobile tool chest - RX-Edition

Workshop Mobile tool chest - **Racing Experience** with 9 drawers

- drawers full extension, ball bearing
- quick lock on each drawer
- central lockable
- multiple extraction possible
- additional folding storage
- plastic edge protection
- side insertion possibility for screwdriver
- 2 swivel castors
- 2 wheels on the outside

### Drawer interior dimension

Width: 570 mm  
 Depth: 410 mm  
 Height 1. - 4. drawer: 53 mm  
 Height 5. - 8. drawer: 82 mm  
 Height 9. drawer: 169 mm

### Drawer load

Top cover 30 kg  
 Top 4 drawers 25 kg  
 Lower 5 drawers 30 kg  
 Total 280 kg



Description	Length	Width	Height	Part no.
black / silver	775 mm	470 mm	1030 mm	07075L

## Workshop cart assortment XXL



Workshop cart with 7 drawers with storage cabinet  
(description s. Item 07092L)

**"Worker-Set"** - 6 drawers equipped with a total of 455 premium quality tools, stored in 1/3, 2/3, 1/1 foam modules

Includes the following equipped modules and tools:

- Z3000-18 - Socket spanner 3/4", impact, 21-piece
- Z3013-1 - Double open-ended spanner, 11-piece
- Z3013-2 - Combination spanner, 15-piece
- Z3013-6 - Double-ring spanner, 8-piece
- Z3013-7 - Double-ring spanner, 3-piece
- Z3013-12 - Socket spanner 1/4", 66-piece
- Z3013-16 - Drive tools 1/2", 8-piece
- Z3013-17 - Socket spanner 1/2", hex, 36-piece
- Z3013-20 - Socket spanner 1/2", square drive, 14-piece
- Z3013-21 - Socket spanner 1/2", XZN tripe square, 12-piece
- Z3013-22 - Socket spanner 1/2", T-Profile, 16-piece
- Z3013-25 - Screwdriver, 9-piece
- Z3013-27 - Screwdriver, T-Profile, 10-piece
- Z3013-30 - RX Workshop pliers, 4-piece
- Z3013-32 - RX Workshop pliers, 3-piece
- Z3013-35 - Pin punch and club hammer, 5-piece
- Z3023-1 - Combination spanner, 6-piece
- 04141L - Bit-set, 208-piece



Description	Part no.
Tool system 07092L incl. 17 equipped modules	Z3817

## Workshop mobile tool chest assortment XL



Workshop cart with 8 drawers  
(description s. Item 07091L)

**"Worker-Set"** - 5 drawers equipped with a total of 455 premium quality tools, stored in 1/3, 2/3 and 1/1 foam modules

Includes the following equipped modules and tools:

- Z3000-18 - Socket spanner 3/4", impact, 21-piece
- Z3013-1 - Double open-ended spanner, 11-piece
- Z3013-2 - Combination spanner, 15-piece
- Z3013-6 - Double-ring spanner, 8-piece
- Z3013-7 - Double-ring spanner, 3-piece
- Z3013-12 - Socket spanner 1/4", 66-piece
- Z3013-16 - Drive tools 1/2", 8-piece
- Z3013-17 - Socket spanner 1/2", hex, 36-piece
- Z3013-20 - Socket spanner 1/2", square drive, 14-piece
- Z3013-21 - Socket spanner 1/2", XZN tripe square, 12-piece
- Z3013-22 - Socket spanner 1/2", T-Profile, 16-piece
- Z3013-25 - Screwdriver, 9-piece
- Z3013-27 - Screwdriver, T-Profile, 10-piece
- Z3013-30 - RX Workshop pliers, 4-piece
- Z3013-32 - RX Workshop pliers, 3-piece
- Z3013-35 - Pin punch and club hammer, 5-piece
- Z3023-1 - Combination spanner, 6-piece
- 04141L - Bit-set, 208-piece



Description	Part no.
Tool system 07091L incl. 17 equipped modules	Z3818

## Workshop mobile tool chest assortment

tool chest with 8 drawers  
(description see article 07091L)

**"Profi-Set"** - 6 drawers equipped with a total of 553 premium quality tools, stored in foam modules.

Includes the following modules and tools:

- Z3013-1 - Set of double open end spanners, 11-pieces
- Z3013-2 - Set of open end spanners, 15-pieces
- Z3013-6 - Set of double ring spanners, cranked, 8-pieces
- Z3013-7 - Set of double ring spanners, cranked, 4-pieces
- Z3013-8 - Set combination ratchet spanner, 12-pieces
- Z3013-12 - Socket set 6,3 mm (1/4"), 66-pieces
- Z3013-14 - Socket set 10 mm (3/8"), 33-pieces
- Z3013-16 - Set of drive tools 12,5 mm (1/2"), 8-pieces
- Z3013-20 - Set of sockets 12,5 mm (1/2"), Inner hexagon, 14-pieces
- Z3013-21 - Set of sockets 12,5 mm (1/2"), Multiple teeth, 12-pieces
- Z3013-22 - Set of sockets 12,5 mm (1/2"), T-profile, 16-pieces
- Z3013-23 - Set of sockets 12,5 mm (1/2"), E-profile, 18-pieces
- Z3013-25 - Set of screwdrivers, 9-pieces
- Z3013-27 - Set of screwdrivers, T-profile, 10-pieces
- Z3013-30 - Set of RX workshop pliers, 4-pieces
- Z3013-32 - Set of RX workshop pliers, 3-pieces
- Z3013-33 - Set of Circlip Pliers, 5-pieces
- Z3013-34 - Set of hammer and pin drivers, 10-pieces
- Z3013-36 - Set of socket set 12,5 mm (1/2"), 12-point, 32-pieces
- Z3013-37 - Set of double ring spanners, E-profile, 12-pieces
- Z3023-1 - Set of open end spanners, long, 6-pieces
- Z3023-5 - Set of T-handle screwdrivers, 37-pieces
- 04141L - Bit-set, 208-piece



Description	Part no.
Tool system 07091L incl. 22 equipped modules	<b>Z3822</b>

## Workshop mobile tool chest assortment

tool chest with 8 drawers  
(description see article 07080L)

**"Profi-Set"** - 8 drawers equipped with a total of 553 premium quality tools, stored in foam modules.

Includes the following modules and tools:

- Z3013-1 - Set of double open end spanners, 11-pieces
- Z3013-2 - Set of open end spanners, 15-pieces
- Z3013-6 - Set of double ring spanners, cranked, 8-pieces
- Z3013-7 - Set of double ring spanners, cranked, 4-pieces
- Z3013-8 - Set combination ratchet spanner, 12-pieces
- Z3013-12 - Socket set 6,3 mm (1/4"), 66-pieces
- Z3013-14 - Socket set 10 mm (3/8"), 33-pieces
- Z3013-16 - Set of drive tools 12,5 mm (1/2"), 8-pieces
- Z3013-20 - Set of sockets 12,5 mm (1/2"), Inner hexagon, 14-pieces
- Z3013-21 - Set of sockets 12,5 mm (1/2"), Multiple teeth, 12-pieces
- Z3013-22 - Set of sockets 12,5 mm (1/2"), T-profile, 16-pieces
- Z3013-23 - Set of sockets 12,5 mm (1/2"), E-profile, 18-pieces
- Z3013-25 - Set of screwdrivers, 9-pieces
- Z3013-27 - Set of screwdrivers, T-profile, 10-pieces
- Z3013-30 - Set of RX workshop pliers, 4-pieces
- Z3013-32 - Set of RX workshop pliers, 3-pieces
- Z3013-33 - Set of Circlip Pliers, 5-pieces
- Z3013-34 - Set of hammer and pin drivers, 10-pieces
- Z3013-36 - Set of socket set 12,5 mm (1/2"), 12-point, 32-pieces
- Z3013-37 - Set of double ring spanners, E-profile, 12-pieces
- Z3023-1 - Set of open end spanners, long, 6-pieces
- Z3023-5 - Set of T-handle screwdrivers, 37-pieces
- 04141L - Bit-set, 208-piece



Description	Part no.
Tool system 07080L incl. 22 equipped modules	<b>Z3618</b>

## Workshop mobile tool chest assortment

Tool chest with 8 drawers  
(Description see article 07080L)

**"Exclusive"** - 7 drawers equipped with a total of 329 premium quality tools, stored in foam modules.

Includes the following modules and tools:

- Z3000-2 - sockets insert, 95-piece
- Z3000-4 - screwdriver insert, 102-piece
- Z3000-21 - spanner insert, 35-pieces
- With high quality combination ratchet es
- Z3000-23 - screwdriver, 38-pieces
- With high quality Racing Experience screwdrivers, all screwdrivers from German production
- Z3000-25 - plier insert , 13-piece
- With high quality Racing Experience tongs from German production
- Z3000-26 - oil / Fuel / Braking Service, 25-pieces
- With the most important tools for oil, fuel and brake service
- Z3000-27 - sheet metal processing / body, 20-piece



### Description

Tool system 07080L incl. 7 equipped modules with high quality Racing Experience tools

### Part no.

**Z3607**

## Workshop mobile tool chest assortment

Tool chest with 8 drawers  
(Description see article 07080L)

**"Exclusive"** - 4 drawers equipped with a total of 181 tools in premium quality, stored in foam modules.

Includes the following modules and tools:

- Z3000-2 - socket insert, 95-piece
- Z3000-21 - spanner insert, 35-pieces
- With high quality combination ratchet spanners
- Z3000-23 - screwdriver insert, 38-pieces
- With high quality Racing Experience screwdrivers all screwdrivers from German production
- Z3000-25 - pliers, 13-piece



### Description

Tool system 07080L incl. 4 equipped modules with high quality Racing Experience tools

### Part no.

**Z3604**

## Workshop mobile tool chest assortment

Tool chest with 9 drawers  
(Description see article 07075L)

**"Complete set"** - 7 drawers equipped with a total of 343 premium quality tools, stored in foam modules.

Includes the following modules and tools:

- Z3000-1 - Spanner insert, 37-piece
- Z3000-2 - socket insert, 95-piece
- Z3000-3 - screwdriver insert, 38-pieces
- Z3000-4 - screwdriver inserts, 102-pieces
- Z3000-5 - plier insert, 14-piece
- Z3000-6 - oil / brake service insert, 36-pieces
- Z3000-7 - sheet metal processing / body insert, 21-piece



### Description

Tool system 07075L incl. 7 equipped modules

### Part no.

**Z3217**





## Workshop mobile tool chest assortment



workshop cart with 9 drawers  
(description s. Item 07075L)

**"Basic Set"** - 5 drawers equipped with a total of 286 premium quality tools, stored in foam modules  
Includes the following equipped modules and tools:

- Z3000-1 - socket spanners, 37 pcs.
- Z3000-2 - box spanners, 95 pcs.
- Z3000-3 - screwdrivers, 38 pcs.
- Z3000-4 - screwdriver bits, 102 pcs.
- Z3000-5 - pliers, 14 pcs.



### Description

### Part no.

Workshop cart 07075L incl. 5 equipped modules inserts

**Z3405**

## Workshop mobile tool chest assortment



workshop cart with 9 drawers  
(description s. Item 07075L)

includes the following equipped modules and tools:

- Z3000-1 - socket spanners, 37 pcs.
- Z3000-2 - box spanners, 95 pcs.
- Z3000-3 - screwdrivers, 38 pcs.
- Z3000-5 - pliers, 14 pcs.
- Z3000-7 - sheet metal working/body, 21 pcs.
- 2x 07010L - drawer partition



### Description

### Part no.

Workshop cart 07075L incl. 5 equipped module inserts and 2 drawer divider

**Z3415**

## Workshop mobile tool chest assortment



Tool chest with 9 drawers  
(Description see article 07075L)

**"Starter set"** - 4 drawers equipped with a total of 272 Premium quality tools, stored in foam modules.

Includes the following modules and tools:

- Z3000-1 - spanner insert, 37-piece
- Z3000-2 - socket Insert, 95-piece
- Z3000-3 - screwdriver insert , 38-pieces
- Z3000-4 - screwdriver insert, 102-piece



### Description

### Part no.

Tool System 07075L incl. 4 equipped modules inserts

**Z3404**

## Workshop mobile tool chest assortment

Tool chest with 9 drawers  
(Description see article 07075L)

**"Premium complete set"** - 7 drawers equipped with a total of 329 tools in premium quality, stored in foam modules.

Includes the following modules and tools:

- Z3000-21 - spanner insert, 35-pieces with high quality combination ratchet spanners
- Z3000-2 - socket insert, 95-piece
- Z3000-23 - screwdriver insert, 38-pieces with high quality Racing Experience screwdrivers all screwdrivers from German production
- Z3000-4 - screwdriver insert, 102-piece
- Z3000-25 - plier insert, 13-piece with high-quality Racing Experience and circlip pliers from German production
- Z3000-26 - oil / Fuel / Braking Service insert, 26-pieces with the most important tools for oil, fuel and brake service
- Z3000-27 - sheet metal processing / body insert , 20-piece



**Description**

**Part no.**

Tool System 07075L incl. 7 equipped modules with high-quality Racing Experience tools

**Z3407**

## Workshop mobile tool chest assortment

workshop cart with 9 drawers  
(description see item 07075L)

**"Premium Complete Set"** - 6 drawers equipped with a total of 304 premium quality tools, stored in foam modules

Contains the following equipped modules and tools:

- Z3000-21 - Socket spanners, 35-piece, with high-quality combination ratchet spanner
- Z3000-2 - Box spanners, 96-piece
- Z3000-23 - Screwdrivers, 38-piece, with high-quality Racing Experience screwdrivers, all screwdrivers made in Germany
- Z3000-4 - Screwdriver bits, 103-piece
- Z3000-25 - Pliers, 13-piece, with high-quality Racing Experience and circlip pliers made in Germany
- Z3000-27 - sheet metal working/body, 20-piece, higher quality hammers, blades and tape compared to standard range



**Description**

**Part no.**

Workshop cart 07075L incl. 6 equipped module with high-quality Racing Experience tools

**Z3406**

## Workshop mobile tool chest assortment

Tool chest with 7 drawers  
(Description see article 07065L)

**"Worker-Set"** - 4 drawers fitted  
With a total of 215 tools in premium-Quality, stored in foam modules.

Contains the following modules:

- Z3000-14 - ratchets + sockets insert , 97-piece
- Z3000-15 - spanner insert, 28-piece
- Z3000-16 - hand tools insert , 18-piece
- Z3000-17 - screwdriver insert, 72-piece



**Description**

**Part no.**

Tool system 07065L incl. 4 equipped modules

**Z3344**





## Workshop mobile tool chest assortment

workshop cart with 7 drawers  
(description s. Item 07065L)

**"Worker-Set"** - 3 drawers equipped with a total of 143 premium quality tools, stored in foam modules  
Includes the following equipped modules and tools:

- Z3000-14 - ratchets + inserts 97-pieces
- Z3000-15 - wrench 28-pieces
- Z3000-16 - hand tools 18-pieces



### Description

Tool System 07065L incl. 3 equipped module inserts

### Part no.

**Z3131**

## Workshop mobile tool chest assortment

Tool chest with 7 drawers  
(Description see article 07050L)

**"Worker-Set"** - 3 drawers equipped  
With a total of 207 tools in premium-Quality, stored in foam modules.

Contains the following modules:

- Z3010-1 - sockets, 171-piece
- Z3010-2 - spanners, 24-pieces
- Z3010-3 - pliers and screwdrivers, 12-piece



### Description

Tool system 07050L incl. 3 equipped modules

### Part no.

**Z3703**

## 3/3 Tool Foam Inserts

### Moulded fit insert

for RX-Edition mobile tool chest.

Large insert for a complete drawer with the following equipment:

- 17 combination spanners 6 - 24 mm
- 6 double joint spanners 8 - 19 mm
- 8 double-ended box spanners, cropped 6 - 22 mm
- 6 double-ended box spanners E-profile E6 - E24



### Description

37-piece Metric spanner set

### Length

410 mm

### Width

570 mm

### Height

40 mm

### Part no.

**Z3000-1**





## Moulded inserts



for RX-Edition mobile tool chest.

Large insert for a complete drawer with the following equipment:

- 10 hexagonal inserts 6,3 mm (1/4"), 4 - 13 mm
- 12 hexagonal inserts 10 mm (3/8"), 8 - 19 mm
- 11 hexagonal inserts 10 mm (3/8"), extra deep 8 - 19 mm
- 17 hexagonal inserts 12,5 mm (1/2"), 10 - 32 mm
- 14 T-profile screwdriver bits 6,3 mm (1/4"), T10 - T40
- 5 internal hexagonal screwdriver bits 6,3 mm (1/4"), 3 - 7 mm
- 1 cross-slot profile screwdriver bit 6,3 mm (1/4") PH2
- 1 slotted profile screwdriver bit 6,3 mm (1/4"), 5,5 mm
- 3 change-over ratchets 6,3 mm + 10 mm + 12,5 mm (1/4", 3/8", 1/2")
- 3 universal joints 6,3 mm + 10 mm + 12,5 mm (1/4", 3/8", 1/2")
- 2 extensions 6,3 mm (1/4") 50 + 100 mm
- 2 extensions 10 mm (3/8") 45 + 150 mm
- 2 extensions 12,5 mm (1/2") 125 + 250 mm
- 1 sliding handle 12,5 mm (1/2") 250 mm
- 2 adapters with knurl 1/4" x 3/8" + 3/8" x 1/2"
- 1 spark plug pliers + 1 glow plug pliers
- 1 magnetic spark plug insert 12,5 mm (1/2"), 21 mm
- 6 spark inserts 10 mm (3/8") 8 - 14 m



Description	Length	Width	Height	Part no.
95-piece Ratchet socket set	410 mm	570 mm	40 mm	Z3000-2

## Moulded inserts



for RX-Edition mobile tool chest.

Large insert for a complete drawer with the following equipment:

- 3 flexible drivers 6, 7, 8 mm
- 9 allen keys, internal hexagon 1,5 - 10 mm extra short, long shank with ball head
- 9 allen keys, T-profile without T10 - T50 hole extra short, long shank with ball head
- 8 T-profile screwdrivers with T 8 - 40 hole
- 4 slot screwdrivers + 4 cross-slot screwdrivers
- 1 polarity tester with puncturing function



Description	Length	Width	Height	Part no.
38-piece Screwdriver set	410 mm	570 mm	40 mm	Z3000-3

## Moulded inserts



for RX-Edition mobile tool chest.

Large insert for a complete drawer with the following equipment:

- 32-piece bit assortment with colour coding
- screwdriver bits 12,5 mm (1/2")
- key groove profile: 3 x 240 mm long M7, M8
- 1 x 100 mm long, M9, 1 x 140 mm long, M10
- 1 x, 120 mm long, M10,3
- Inner hexagon, 7 x 53 mm long, 5 - 14 mm
- 6 x 100 mm long, 5 - 12 mm
- XZN tripe square: 5 x 53 mm long, M6 - M14
- 5 x 100 mm long, M6 - M14
- T-profile without hole: 7 x 53 mm long, T25 - T55
- 7 x 100 mm long, T25 - T55, 1 x 140 mm long, T70
- 9 spiral slot bits to loosen damaged nuts/screws 10 - 19 mm
- 9 E-profile box spanners 1/2" E10 - E24
- 9 five-start bits 1/4" IP10 - IP50



Description	Length	Width	Height	Part no.
102-piece Assorted bit set	410 mm	570 mm	40 mm	Z3000-4





## Moulded inserts

DIN CrV ■■■ YYY

for RX-Edition mobile tool chest.

Large insert for a complete drawer with the following equipment:

- 1 combination pliers 180 mm
- 1 side-cutting pliers 180 mm
- 2 long-nosed pliers 200 mm straight + bent
- 4 circlip pliers 175 mm straight + bent for exterior and interior circlips
- 1 circlip pliers 220 mm for wheel bearing circlips
- 1 mini-grip pliers 100 mm with semi-circular jaws
- 1 grip pliers 250 mm with forged jaws
- 3 high-strength water pump pliers 175, 240, 300 mm



Description	Length	Width	Height	Part no.
14-piece Assorted pliers set	410 mm	570 mm	40 mm	Z3000-5

## Moulded inserts

CrV 12.5 10 3/8 ■■■ YYY

for RX-Edition mobile tool chest.

Large insert for a complete drawer with the following equipment:

- 3 brake calliper special bits, inner hexagon
- 7 x 24 mm (Mercedes C-Class W204)
- 8 x 24 mm (Audi A4, A6, A8, TT)
- 9 x 60 mm (Mercedes M-/R-Class W164/W251)
- 1 brake piston wind-back cube
- 3 brake calliper special bits, pentagon
- 10 x 56 Innen (girling brake calliper)
- 14 x 38 Außen (e.g. Smart)
- 19 x 38 Außen (e.g. Astra G, Zafira)
- 2 pin punches for brake pins
- 2 brake calliper brushes brass / steel facing
- 1 brake calliper file, extra narrow, milled on 4 sides
- 1 special mole wrench for brake / bleeding nipples
- 1 brake disc gauge
- 2 double joint line spanner 10 - 13 mm
- 2 oil service special sockets 8 / 10 mm square with 1/2 box spanner, M16 square with hole
- 11 universal oil service spanner, square 8, 11, 13, 3/8"
- hexagon 8, 9, 10, 12, 14, 17 + 3/8"
- 1 sliding handle for oil service spanner
- 1 metal strap oil-filter spanner
- 1 oil filter pliers 60 - 90 mm
- 3 oil filter cartridge inserts 27 - 32 - 36 mm
- 1 oil filter cap 74 mm, 14 edges
- (VW, Mercedes, BMW, Audi, Opel)



Description	Length	Width	Height	Part no.
36-piece Oil and brake service set	410 mm	570 mm	40 mm	Z3000-6

## Moulded inserts

HSS CrV ■■■ YYY

for RX-Edition mobile tool chest.

Large insert for a complete drawer with the following equipment:

- 1 locksmith's hammer 500g with fibreglass handle
- 1 planishing hammer 35 mm
- 1 professional mini saw
- 1 tape measure 2 m
- 1 precision calliper gauge 150 mm measuring range
- 1 marker + 6 pin punches 2 - 8 mm
- 1 jackknife with trapezoidal blades
- 3 workshop files, flat, semicircular, triangular
- 1 flat chisel 200 mm + 1 cross-cut chisel 175 mm
- 1 centre punch 120 x 10 mm
- 1 HSS twist drill 4 - 20 mm
- 1 titanium nitrided weld spot drill 8 mm



Description	Length	Width	Height	Part no.
21-piece Sheet metal set	410 mm	570 mm	40 mm	Z3000-7





## Moulded inserts



for RX-Edition mobile tool chest.

Large inlay for a complete drawer equipped as follows:

- 8 open-ended wrenches 6 - 22 mm
- 14 combination wrenches 8 - 24 mm
- 6 double-ended ring wrenches, offset 8 - 19 mm

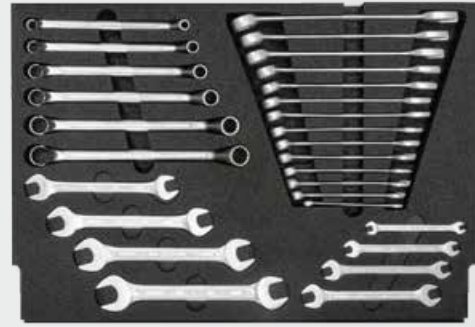

Description	Length	Width	Height	Part no.
28-piece - Metric spanner set	410 mm	570 mm	40 mm	Z3000-15

## Moulded inserts



for RX-Edition mobile tool chest.

Large inlay for a complete drawer equipped as follows:

- 1 screwdriver set, 6-part, impact-resistant, slot 5.0 - 8.0, PH1-2-3
- 1 professional side cutter 160 mm
- 1 set of professional telephone pliers 200 mm
- 1 set of professional water pump pliers
- 1 machinist's hammer, hickory, 500 g
- 1 polarity probe with LED display, 3 - 48V
- 6 pin punches 2 - 8 mm
- 1 centre punch 120 x 12 mm



Description	Length	Width	Height	Part no.
18-piece - General maintenance set	410 mm	570 mm	40 mm	Z3000-16

## Moulded inserts



for RX-Edition mobile tool chest.

Large inlay for a complete drawer equipped as follows:

- Screwdriver insert bits 1/2" in the following profiles and lengths:
  - 6 internal hex 53 mm long, 5 - 14 mm
  - 7 internal hex 100 mm long, 5 - 12 mm
  - 5 XZN tripe square 53 mm long, 6 - 14 mm
  - 5 XZN tripe square 100 mm long, 6 - 14 mm
  - 7 T-profile 53 mm long, T25 - T55
  - 7 T-profile 100 mm, T27 - T55
  - 1 RIBE 10.3 x 120
- Screwdriver insert bits 1/4" in the following profiles and lengths:
  - 6 internal hex 53 mm, 3 - 8 mm
  - 7 T-profile with face bore 38 mm, T10 - T40
  - 7 T-profile without face bore 38mm, T10 - T40
  - 1 slot, 5.5 mm
  - 1 Phillips PH2
- 9 socket wrench insert bits 1/2" E-profile 38 mm, E10 - E24
- 1 Adapter set, 3-part, 1/4" - 3/4"

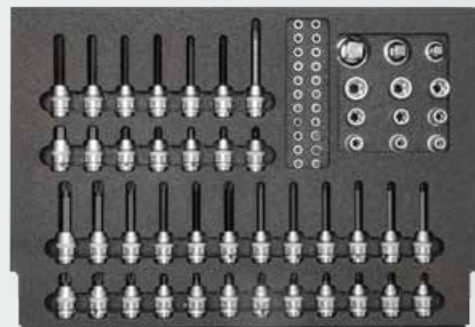

Description	Length	Width	Height	Part no.
72-piece - Socket / bit set	410 mm	570 mm	40 mm	Z3000-17

## Moulded inserts



for RX-Edition mobile tool chest.

In solid petrol- and solvent-resistant fitting.

Socket set 20 mm (3/4"), impact:

- reversible ratchet with screwed shaft 500 mm
- 6, inserts 19, 21, 22, 23, 24, 26, 27, 29, 30, 32, 35, 36, 38, 41, 46,
- universal joint
- extensions 100 mm and 250 mm
- sliding handle 450 mm



## Moulded inserts



for RX-Edition mobile tool chest.

Large inlay for a complete drawer equipped as follows:

- 17 combination wrenches 6 - 24 mm
- 4 combination ratchet wrenches 10 - 19 mm
- 8 double-ended ring wrenches 6 - 22 mm
- 6 double-ended ring wrenches, E-profile E6 - E24

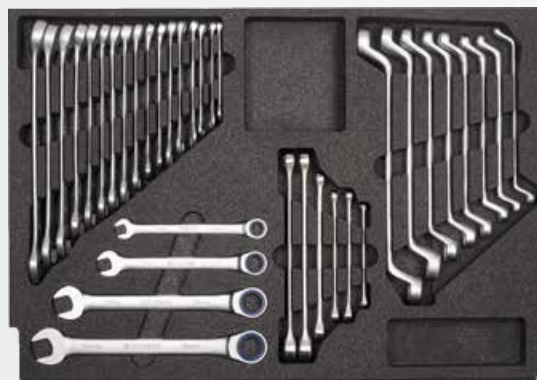

Description	Length	Width	Height	Part no.
35-piece - Spanner set	410 mm	570 mm	40 mm	Z3000-21

## Moulded inserts



for RX-Edition mobile tool chest.

Large inlay for a complete drawer equipped as follows:

- 3 flexible screwdrivers 6, 7, 8 mm
- 9 offset wrenches 1.5 - 10 mm
- extra short, long leg with ball head
- 9 offset wrenches T-profile without hole T10 - T50
- extra short, long leg with ball head
- 1 screwdriver, groove 6.0 x 25, short
- 1 screwdriver, Phillips PH 2, short
- 14 garage screwdrivers, Racing Experience made in Germany:
- 8 x T-profile with hole T8 - T40
- 3 x groove 4.5 - 6.5 - 8.0 mm
- 3 x Phillips head PH1, 2, 3
- 1 polarity probe with puncture function



Description	Length	Width	Height	Part no.
38-piece - Screwdriver set	410 mm	570 mm	40 mm	Z3000-23

## Moulded inserts

for RX-Edition mobile tool chest.

Large inlay for a complete drawer equipped as follows:

- Racing Experience pliers made in Germany:
  - 1 set of combination pliers 180 mm
  - 1 set of cutting pliers 160 mm
  - 2 telephone pliers 200 mm straight + curved
  - 1 set of water pump pliers 240 mm
- 4 circlip pliers 175 mm straight + curved for internal and external locking rings
- 1 set of circlip pliers 220 mm for wheel bearing circlips
- 1 set of mini-gripping pliers 100 mm with half-round cheeks
- 1 set of gripping pliers 250 mm with forged cheeks
- 1 set of mechanic's nippers 250 mm

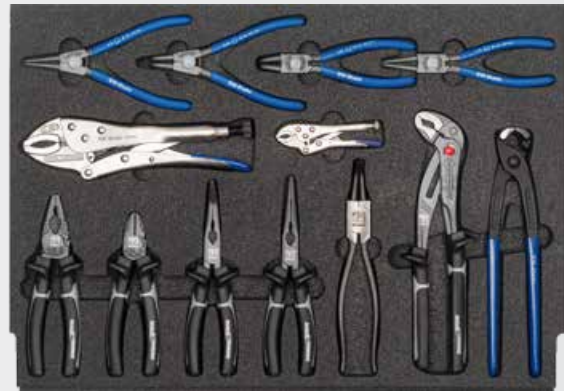

Description	Length	Width	Height	Part no.
13-piece - Pliers	410 mm	570 mm	40 mm	Z3000-25

## Moulded inserts



for RX-Edition mobile tool chest.

Large inlay for a complete drawer equipped as follows:

- 4 special calliper inserts, internal hex:
  - 7 x 24 mm (Mercedes-Benz C class (W204))
  - 8 x 24 mm (Audi A4, A6, A8, TT)
  - 9 x 60 mm (Mercedes-Benz M/R class W164/W251)
  - 7 x 61 mm (BMW 3, 5 and 8 series and Opel)
- 3 special calliper inserts, pentagon:
  - 10 x 56 internal (Girling callipers)
  - 14 x 38 external (e.g. Smart)
  - 19 x 38 external (e.g. Astra G, Zafira)
- 2 pin punches for brake pins
- 2 calliper brushes, brass / steel edging
- 1 calliper file, extra slim, cut 4-sided
- 1 set of special round-jaw gripping pliers for brake / bleeder nipple
- 1 brake disc calliper
- 2 double-jointed pipe wrenches 10 - 13 mm
- 2 special oil service inserts:
  - 8 / 10 mm square (Renault, Peugeot) with 1/2 socket wrench
  - M16 XZN tripe square with hole (Audi, VW)
- 1 brake cable spring pliers
- 1 metal strip oil filter removing wrench
- 1 set of oil filter pliers 60 - 90 mm
- 1 oil filter cap 74 mm, 14 edges (VW, Mercedes-Benz, BMW, Audi, Opel)
- 1 set of spring clamp pliers
- 2 hose clamps



Description	Length	Width	Height	Part no.
26-piece oil / fuel / brake service	410 mm	570 mm	40 mm	Z3000-26

## Moulded inserts



for RX-Edition mobile tool chest.

Large inlay for a complete drawer equipped as follows:

- 1 machinist's hammer 500 g with hickory shaft
- 1 dinging hammer 35 mm
- 1 professional miniature saw bow
- 1 measuring tape 5 m
- 1 set of precision callipers 150 mm measurement range
- 6 pin punches 2 - 8 mm
- 1 safety knife
- 3 garage files: flat, half-round, triangular
- 1 flat chisel 200 mm
- 1 cross-cut chisel 175 mm
- 1 centre punch 120 x 10 mm
- 1 HSS step drill 4 - 20 mm
- 1 TIN spot weld drill 8 mm



Description	Length	Width	Height	Part no.
20-piece general workshop set	410 mm	570 mm	40 mm	Z3000-27

## Moulded inserts



for RX-Edition mobile tool chest.

Large inlay for a complete drawer equipped as follows:

- Assembly wedge set, 5-part
- Wiper arm extractor, 9-part
- Terminal extractor, cars and trucks
- Telescope magnetic lift, 120 - 650 mm, 7.5 mm
- Door panelling remover, 260 mm
- Special insert T80 with hole for BMW wiper arm



Description	Length	Width	Height	Part no.
19-piece <b>glass fitting set</b>	410 mm	570 mm	40 mm	<b>Z3000-10</b>

## Moulded inserts



for RX-Edition mobile tool chest.

Large inlay for a complete drawer equipped as follows:

- One-man glass removal tool set
- Special scraper set, 27 parts
- 50 m square wire, up to 2,400 Nm
- 22.5 m wire, twisted, highly flexible
- Glass removal knife set
- Wire feed probe, 100 mm
- Wire retainer, 355 mm
- Parting awl
- Side cutter, 180 mm
- Telephone pliers, 200 mm



Description	Length	Width	Height	Part no.
39-piece <b>glass dismantling set</b>	410 mm	570 mm	40 mm	<b>Z3000-11</b>

## Moulded inserts



for RX-Edition mobile tool chest.

Large inlay for a complete drawer equipped as follows:

- Compressed air glass remover
- various blades, 18-36-52-63-90 mm long
- Professional scraper, blade 1.1 x 30 mm
- Safety eyewear according to DIN EN 166
- Glass removal set, cars and trucks



Description	Length	Width	Height	Part no.
17-piece <b>glass dismantling set</b>	410 mm	570 mm	40 mm	<b>Z3000-12</b>





## Moulded insert



for equipping workshop mobile tool chest cart

A large insert for a complete drawer with the following tools:

- 16 combination spanners: 6, 7, 8, 9, 10, 11, 12, 13, 14, 15, 16, 17, 18, 19, 21, 22 mm
- 8 ring spanners cropped: 6x7, 8x9, 10x11, 12x13, 14x15, 16x17, 18x19, 20x22 mm

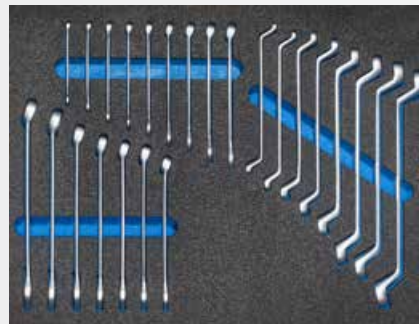

① Only suitable for tool trolley 07050L!

Description	Length	Width	Height	Part no.
24-piece	545 mm	395 mm	60 mm	Z3010-2

## Moulded insert



for equipping workshop mobile tool chest cart

A large insert for a complete drawer with the following tools:

- 5 screwdrivers, slot: 2.0x63 mm, 3.0x80 mm, 4.0x100 mm, 5.5x125 mm, 6.5x150 mm
- 3 screwdrivers, philips: PH1x80 mm, PH2x100 mm, PH3x150 mm
- 1 universal pliers: 180 mm
- 1 side-cutting pliers: 180 mm
- 1 telephone pliers, straight: 200 mm
- 1 water pump pliers: 250 mm



① Only suitable for tool trolley 07050L!

Description	Length	Width	Height	Part no.
12-piece	545 mm	395 mm	60 mm	Z3010-3

# 2/3 Foam Inserts

## Moulded insert



for workshop mobile tool chest, RX-series.

In petrol- and solvent-resistant fit insert.

Set of open end spanners, long:

- metric 21, 22, 24, 27, 30, 32 mm



① 2/3 insert

Description	Length	Width	Part no.
6-piece Metric long open end spanner set	400 mm	378 mm	Z3023-1

## Moulded insert



for workshop mobile tool chest, RX-series.

In petrol- and solvent-resistant fit insert

Set combination Ratchet spanner:

- key width 21, 22, 24, 27, 30, 32mm



① 2/3 insert

Description	Length	Width	Part no.
6-piece Metric combination ratchet ring spanner set	400 mm	378 mm	Z3023-2





## Moulded insert

for workshop mobile tool chest, RX-series.

In petrol- and solvent-resistant fit insert

Truck bit set in 20 mm (3/4") und 25 mm (1"):

- internally hexagonal 14, 17, 19, 21, 22, 23, 24
- allen key long 17, 19, 22, 24
- multiple teeth M16, 18
- T profile long T60, 70, 80, 90, 100
- E profile long E18, 20, 22, 24



① 2/3 insert

Description	Length	Width	Part no.
25-piece Metric CV bit set	400 mm	378 mm	Z3023-3

## Moulded insert

for workshop mobile tool chest, RX-series.

In petrol- and solvent-resistant fit insert

- caliper key 7 x 100 mm
- caliper key 8 x 100 mm
- caliper key 9 x 60 mm
- caliper key 11 x 140 mm
- universal pistons windback tool
- universal piston adapter set
- brake line spanner 10, 11, 12, 13 mm
- brush saddle brush steel wire
- brake cable spring pliers
- bleed nipple pliers
- brake caliper files



① 2/3 insert

Description	Length	Width	Part no.
18-piece Caliper service set	400 mm	378 mm	Z3023-4

## Moulded insert

for workshop mobile tool chest, RX-series.

In petrol- and solvent-resistant fit insert

Set of T handle screwdrivers:

- hexagon socket 2, 2.5, 3, 4, 5, 6, 8, 10
- T profile without bore T10 - T50
- T-profile with hole T10 - T50
- 5-star with bore T10 - T50
- T-handle size 8, 10, 12, 13



① 2/3 insert

Description	Length	Width	Part no.
8-piece T profile screwdriver set	400 mm	378 mm	Z3023-5

## Moulded insert

for workshop mobile tool chest, RX-series.

In petrol- and solvent-resistant fit insert

Set of double open end spanners:

- spanner dimensions 6x7, 8x9, 10x11, 12x13, 14x15, 16x17, 18x19, 21x22, 24x27, 30x32 mm



① 1/3 insert

Description	Length	Width	Part no.
11-piece Metric spanner set	400 mm	189 mm	Z3013-1

## Moulded insert

for workshop mobile tool chest, RX-series.

In petrol- and solvent-resistant fit insert

Set of open end spanners:

- key width 6 - 19, 21, 22 mm

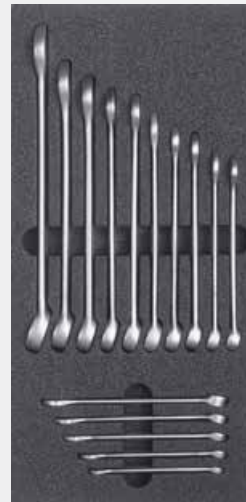

① 1/3 insert

Description	Length	Width	Part no.
15-piece Open end spanner set	400 mm	189 mm	Z3013-2

## Moulded insert

for workshop mobile tool chest, RX-series.

In petrol- and solvent-resistant fit insert

Set of combination spanners, short:

- Metric 10 - 19 mm

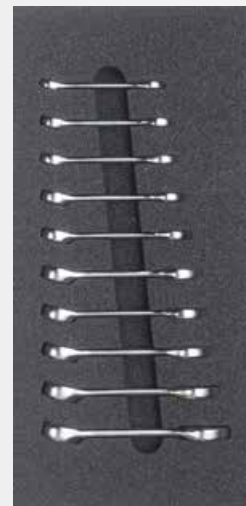

① 1/3 insert

Description	Length	Width	Part no.
10-piece Metric combination spanners short set	400 mm	189 mm	Z3013-3





## Moulded insert



for workshop mobile tool chest, RX-series.

In petrol- and solvent-resistant fit insert

Set of open end spanners, long:  
 ▪ metric 6 - 19 mm

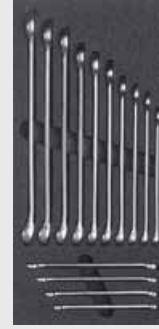

① 1/3 insert

Description	Length	Width	Part no.
14-piece Metric long spanner set	400 mm	189 mm	Z3013-4

## Moulded insert



for workshop mobile tool chest, RX-series.

In petrol- and solvent-resistant fit insert

Set of double ring spanners, straight:  
 ▪ key width 6x7, 8x9, 10x11, 12x13, 14x15, 16x17, 18x19, 21x22, 24x27, 30x32 mm



① 1/3 insert

Description	Length	Width	Part no.
12-piece Metric ring spanner set	400 mm	189 mm	Z3013-5

## Moulded insert



for workshop mobile tool chest, RX-series.

In petrol- and solvent-resistant fit insert

Set of double ring spanners, cranked:  
 ▪ metric 6x7, 8x9, 10x11, 12x13, 14x15, 16x17, 18x19, 20x22 mm



① 1/3 insert

Description	Length	Width	Part no.
8-piece Metric double ring spanners cranked set	400 mm	189 mm	Z3013-6

## Moulded insert



for workshop mobile tool chest, RX-series.

In petrol- and solvent-resistant fit insert

Set of double ring spanners, cranked:  
 ▪ metric 21, 23, 24, 27, 30, 32 mm

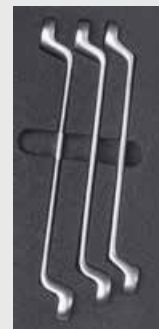

① 1/3 insert

Description	Length	Width	Part no.
4 piece, metric double ring spanner set	400 mm	189 mm	Z3013-7

## Moulded insert



for workshop mobile tool chest, RX-series.

In petrol- and solvent-resistant fit insert.

Set of double ring spanners, E-profile:

- Straight version in E6, E7, E8, E10, E11, E12, E14, E16, E18, E20, E22, E24
- Cranked version in E6, E7, E8, E10, E11, E12, E14, E16, E18, E20, E22, E24



① 1/3 insert

Description	Length	Width	Part no.
12-piece Double ring spanner set	400 mm	189 mm	Z3013-37

## Moulded insert



for workshop mobile tool chest, RX-series.

In petrol- and solvent-resistant fit insert

Set combination ratchet spanner:

- metric 8 - 19 mm

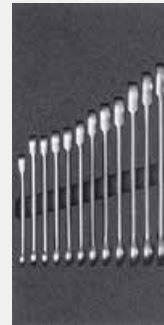

① 1/3 insert

Description	Length	Width	Part no.
12-piece Combination ratchet spanner set	400 mm	189 mm	Z3013-8

## Moulded insert



for workshop mobile tool chest, RX-series.

In petrol- and solvent-resistant fit insert

Set of open sprocket spanner, with joint:

- metric 8 - 19 mm

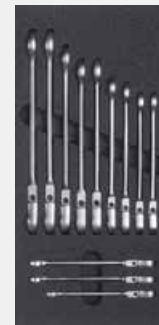

① 1/3 insert

Description	Length	Width	Part no.
12-piece Metric combination ratchet spanner set	400 mm	189 mm	Z3013-9





## Moulded insert

for workshop mobile tool chest, RX-series.

In petrol- and solvent-resistant fit insert

Set open spanner, crowfoot:

- key range 10 - 32
- joint handle 385 mm
- extension 125 mm
- adapter 3/8" - 1/2"



① 1/3 insert

Description	Length	Width	Part no.
12-piece Set open spanner, crowfoot	400 mm	189 mm	Z3013-10

## Moulded insert



for workshop mobile tool chest, RX-series.

In petrol- and solvent-resistant fit insert

Set of socket adapter, Impact:

- 6,3 mm (1/4") inside x 10 mm (3/8") outside
- 10 mm (3/8") inside x 6.3 mm (1/4") outside
- 10 mm (3/8") inside x 12.5 mm (1/2") outside
- 12.5 mm (1/2") inside x 10 mm (3/8") outside
- 12.5 mm (1/2") inside x 20 mm (3/4") outside
- 20 mm (3/4") inside x 12,5 mm (1/2") outside
- 20 mm (3/4") inside x 25 mm (1") outside
- 25 mm (1") inside x 20 mm (3/4") outside
- ball joint: 10 mm (3/8"), 12.5 mm (1/2"), 20 mm (3/4")
- drilling machine adapter
- 1/4", 3/8", 1/2" square with 1/4" hexagonal drive



① 1/3 insert

Description	Length	Width	Part no.
14-piece Impact socket adapter set	400 mm	189 mm	Z3013-11

## Moulded insert



for workshop mobile tool chest, RX-series.

In petrol- and solvent-resistant fit insert

Set of spiral slot inserts:

- for internal profile screws with M2 - M14
- for external profile bolts and nuts, SW 10 - 19



① 1/3 insert

Description	Length	Width	Part no.
19-piece Spiral slot socket set	400 mm	189 mm	Z3013-13



## Moulded insert



for workshop mobile tool chest, RX-series.

In petrol- and solvent-resistant fit insert

Socket set 6,3 mm (1/4"):

- lever change-over ratchet with quick-release 72 teeth
- handle with 6.3 mm (1/4 ") drive and output
- inserts 4 - 14 mm, in short and long
- PH 1-2-3 + slot 4-5.5-6
- T-profile with bore T10-15-20-25-30-40
- hexagon socket 3-4-5-6-7-8 mm
- E profile E4-5-6-7-8-10-11
- universal joint
- 5-star with hole T10-15-20-25-27-30-40-45-50
- 2 extensions
- extension flexible, 150 mm
- sliding handle
- hexagon socket 1,5-2-2,5 mm

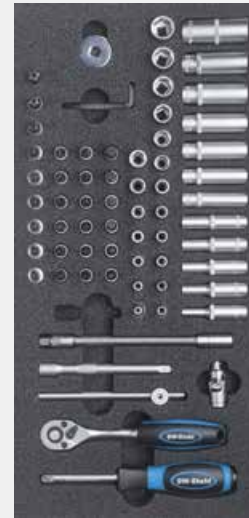

① 1/3 insert

Description	Length	Width	Part no.
66-piece Socket set	400 mm	189 mm	Z3013-12

## Moulded insert



for workshop mobile tool chest, RX-series.

In solid petrol- and solvent-resistant fit insert

Socket set 10 mm (3/8"):

- ergo changeover ratchet with quick-release 72 teeth
- hexagon inserts 6 - 20, 22, 24 mm, in short and long
- universal joint
- 2 tipping extensions, 75mm, 150 mm
- sliding handle



① 1/3 insert

Description	Length	Width	Part no.
33-piece Socket set	400 mm	189 mm	Z3013-14

## Moulded insert



for workshop mobile tool chest, RX-series.

In solid petrol- and solvent-resistant fit insert

Bit assortment 10 mm (3/8"):

- inserts E-profile, E10, 11, 12, 14, 16, 18
- hexagon socket 3, 4, 5, 6, 7, 8, 10 mm
- T profile without bore T15, 20, 25, 27, 30, 40
- T profile with bore T15, 20, 25, 27, 30, 40
- multiple teeth 8, 10, 12
- PH 1, 2, 3
- slot 5,5, 7, 8



① 1/3 insert

Description	Length	Width	Part no.
34-piece Bit assortment	400 mm	189 mm	Z3013-15



## Moulded insert



for workshop mobile tool chest, RX-series.

In petrol- and solvent-resistant fit insert

Set of drive tools 12,5 mm (1/2"):

- ergo changeover ratchet with quick-release 72 teeth
- universal joint
- sliding handle
- 2 tilt extensions 50 mm
- tilting extension 125 mm, 250 mm and 375 mm



① 1/3 insert

Description	Length	Width	Part no.
8-piece Ratchet drive set	400 mm	189 mm	Z3013-16

## Moulded insert



for workshop mobile tool chest, RX-series.

In petrol- and solvent-resistant fit insert

Set of metric sockets 12,5 mm (1/2"), hexagonal:

- key widths short 8 - 25, 27, 28, 30, 32 mm
- key widths long 10 - 22, 24 mm



① 1/3 insert

Description	Length	Width	Part no.
36-piece Metric socket set	400 mm	189 mm	Z3013-17

## Moulded insert



for workshop mobile tool chest, RX-series.

In petrol- and solvent-resistant fit insert

Set of socket set 12,5 mm (1/2"), 12-point:

- key widths short 8 - 22, 24, 27, 30, 32
- key widths long 10 - 19, 21, 22, 24



① 1/3 insert

Description	Length	Width	Part no.
32-piece Metric 12 point socket set	400 mm	189 mm	Z3013-36

## Moulded insert



for workshop mobile tool chest, RX-series.

In petrol- and solvent-resistant fit insert

Set of metric socket 12,5 mm (1/2"), impact, hexagonal:

- key widths short 10 - 19, 21, 22, 24, 27, 30, 32 mm
- key widths long 10 - 19, 21, 22, 24 mm



① 1/3 insert

Description	Length	Width	Part no.
29-piece Metric socket set, impact	400 mm	189 mm	Z3013-18







## Moulded insert



for workshop mobile tool chest, RX-series.

In petrol- and solvent-resistant fit insert

Set of impact sockets 20 mm (3/4"):

- extra long 12 point inserts 27, 30, 32, 34, 36
- internally hexagonal 14, 17, 19
- impact Adapter 12,5 mm (1/2") - 20 mm (3/4")



① 1/3 insert

Description	Length	Width	Part no.
9-piece Impact socket set	400 mm	189 mm	Z3013-24

## Moulded insert

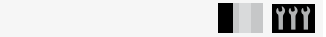

for workshop mobile tool chest, RX-series.

In petrol- and solvent-resistant fit insert

Set of screwdrivers:

- screwdriver slot 2, 3, 4, 5.5, 6.5
- screwdriver cross PH0, 1, 2, 3



① 1/3 insert

Description	Length	Width	Part no.
9-piece Screwdriver set	400 mm	189 mm	Z3013-25

## Moulded insert

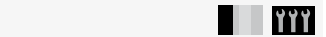

for workshop mobile tool chest, RX-series.

In petrol- and solvent-resistant fit insert

Set of screwdrivers, impact resistant:

- screwdriver slot 4,5, 5,5, 8
- screwdriver cross PH1, 2



① 1/3 insert

Description	Length	Width	Part no.
5-piece Screwdriver set	400 mm	189 mm	Z3013-26

## Moulded insert

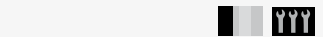

for workshop mobile tool chest, RX-series.

In petrol- and solvent-resistant fit insert.

Set screwdriver T-profile:

- T profile without bore T6, 7, 8, 9, 10, 15, 20, 25, 27, 30



① 1/3 insert

Description	Length	Width	Part no.
10-piece T-profile screwdriver set	400 mm	189 mm	Z3013-27



## Moulded insert



for workshop mobile tool chest, RX-series.

In petrol- and solvent-resistant fit insert

Set of RX workshop pliers :

- RX side cutter, 180 mm
- RX straight pliers, straight, 200 mm
- RX-pointed pliers, bent, 200 mm
- RX water pump, 240 mm

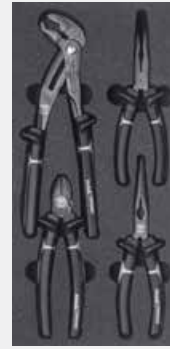

① 1/3 insert

Description	Length	Width	Part no.
4-piece RX-workshop plier set	400 mm	189 mm	Z3013-30

## Moulded insert



for workshop mobile tool chest, RX-series.

In petrol- and solvent-resistant fit insert

Set of RX workshop pliers:

- RX-combination, 180 mm
- RX power cutter, 255 mm
- RX-angled-Combination



① 1/3 insert

Description	Length	Width	Part no.
3-piece RX workshop plier set	400 mm	189 mm	Z3013-32

## Moulded insert



for workshop mobile tool chest, RX-series.

In petrol- and solvent-resistant fit insert

Set of workshop pliers:

- side cutter, 180 mm
- straight pliers, straight, 200 mm
- needle nose pliers, bent, 200 mm
- water pump, 250 mm



① 1/3 insert

Description	Length	Width	Part no.
4-piece Workshop pliers set	400 mm	189 mm	Z3013-29

## Moulded insert



for workshop mobile tool chest, RX-series.

In petrol- and solvent-resistant fit insert

Set of workshop Pliers:

- combination pliers, 180 mm
- power side cutter, 255 mm
- top cutter, 250 mm



① 1/3 insert

Description	Length	Width	Part no.
3-piece Workshop pliers set	400 mm	189 mm	Z3013-31



## Moulded insert



for workshop mobile tool chest, RX-series.

In petrol- and solvent-resistant fit insert

Set of Circlip Pliers:

- circlip pliers, straight, outside
- circlip pliers, curved, outside
- circlip pliers, straight, inside
- circlip pliers, curved, inside
- circlip pliers, wheel bearings



① 1/3 insert

Description	Length	Width	Part no.
5-piece Circlip plier set	400 mm	189 mm	Z3013-33

## Moulded insert



for workshop mobile tool chest, RX-series.

In petrol- and solvent-resistant fit insert

- hammer, 500 g
- pin drivers 2, 3, 4, 5, 6, 8, 10 mm
- flat chisel, 200 mm



① 1/3 insert

Description	Length	Width	Part no.
10-piece Hammer and punch set	400 mm	189 mm	Z3013-34

## Moulded insert



for workshop mobile tool chest, RX-series.

In petrol- and solvent-resistant fit insert.

- mallet, 1000 g
- pin drivers 10, 12, 14, 16 mm



① 1/3 insert

Description	Length	Width	Part no.
5-piece Mallet and punch set	400 mm	189 mm	Z3013-35

## Moulded insert



for workshop mobile tool chest, RX-series.

In petrol- and solvent-resistant fit insert.

Set of wheel changing tools:

- thread fitting set M12x1.25 / M12x1.50 / M14x1.50
- profile depth gauge, digital
- wheel nut insert 15, 17, 19, 21, 22
- wheel nut insert Mercedes special screw



① 1/3 insert

Description	Length	Width	Part no.
18-piece Wheel changing tools	400 mm	189 mm	Z3013-28

## Moulded insert



for workshop mobile tool chest, RX-series.

In petrol- and solvent-resistant fit insert

Set with oil tools:

- oil drain screw repair M14x1.5
- XZN tripe square M16
- oil filter bell Alu 74mm / 14 edge
- oil filter key 60 - 80 mm and 80 - 110 mm
- oil filter key with adjustable metal band
- oil key set



① 1/3 insert

Description	Length	Width	Part no.
16-piece Oil tool set	400 mm	189 mm	Z3013-19

## Moulded insert



for workshop mobile tool chest, RX-series.

In petrol- and solvent-resistant fit insert.

- Spark plug brush, made of brass, 140 mm
- Spark plug socket with ball joint, Bi-hexagon, wrench size 14 mm, 16 mm and 21 mm
- Hinged extension, 3/8", 125 mm
- Adapter, reducer socket, 3/8" - 1/2"
- Spark plug connector pliers
- Glow plug plier
- Glow-plug socket size 12 for PSG glow plugs, incl. 5 protective caps.



① 1/3 insert

Description	Length	Width	Part no.
14-piece Ignition	400 mm	189 mm	Z3013-38

## Accessories

### Document holder



for workshop mobile tool chests 07080L, 07091L and 07092L.



Description	Part no.
Document holder	07081L

### Paper holder



for workshop mobile tool chests 07080L, 07091L and 07092L.

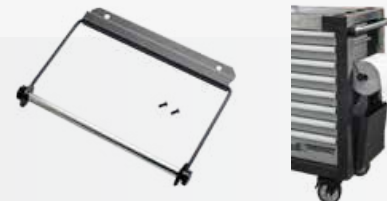

Description	Part no.
Paper holder	07082L

### Edge protection



for workshop mobile tool chests 07080L, 07091L and 07092L.



Description	Part no.
Multiplex insert plate	07083L





## Adapter strip

for the use of SW-Stahl module inserts in workshop carts from other manufacturers



Description	Length	Width	Part no.
Side adapter	335 mm	25 mm	<b>Z2500-ADAPTER1</b>
Side adapter	335 mm	40 mm	<b>Z2500-ADAPTER2</b>
Front/back adapter	40 mm	530 mm	<b>Z2500-ADAPTER3</b>

## Adapter strips

for use of the module inserts from the SW-Stahl standard system in garage trolleys 07065L, 07075L and 07080L

The adapter strips are added to the module inserts used 1/1 for this format on two sides in order to fill the complete drawer. The cuts enable use of the adapter strips to accommodate small parts or additional tools.

- 'Front' insert: 543 x 65 mm
- 'Side' insert: 83 x 320 mm



Description	Part no.
2-piece	<b>07000L</b>

## Drawer partition

for workshop mobile tool chest 07091L, comprising 2 cross rails and 4 dividers

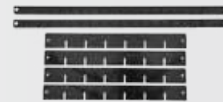

Description	Part no.
6-piece	<b>07014L</b>

## Drawer partition

for workshop mobile tool chest 07050L, comprising 2 cross rails and 4 dividers



Description	Part no.
6-piece	<b>07013L</b>

## Drawer partition

for workshop mobile tool chest 07060L, comprising 2 cross rails and 4 dividers



Description	Part no.
6-piece	<b>07011L</b>

## Drawer partition

for workshop mobile tool chest 07065L, 07075L and 07080L, comprising 2 cross rails and 4 dividers



Description	Part no.
6-piece	<b>07010L</b>

## Placement shell set

with magnet for fixing on all metallic surfaces.

- 150-210-310 x 120 mm
- Delivery without workshop mobile tool chest



Description	Part no.
3-piece	07005L
3-piece with two foamed material	07020L
2 foamed material insert	07015L

## Storage compartment

for magnetic attachment to all metal surfaces e.g. workshop mobile tool chest, workbench etc..

The rubber coating on the 6 powerful magnets prevents coated surfaces becoming scratched. Frequently used tools such as screwdrivers, T-handle wrenches etc. are always on hand thanks to 10 universal round holes à 19.5 mm dia. in the base.

- Inner dimensions: 210 x 73 x 70 mm
- 1.8 kg maximum capacity
- Suitable for 3 spray cans à 70 mm dia.



Part no.  
07006L

## Consumables dish

magnetic, made of stainless steel, for holding screws, nuts etc.



Description	Part no.
approx. 150 mm diameter	07356L
approx. 290 x 270 mm	07357L

## Consumables dish

magnetic, made of stainless steel, for holding screws, nuts etc.



Description	Part no.
approx. 290 x 270 mm	07357L

## Consumables dish

with magnetic clamp, diameter approx. 150 mm. The one-sided higher shape makes it possible to store non-magnetic parts made of aluminium, brass and stainless steel for the first time, making it indispensable at any workstation.



Description	Part no.
approx. 150 mm diameter	07358L



## Magnetic stand for tyre station

for tyre station, for attachment to lifting platforms and all metallic surfaces.

Avoids damage to the impact wrench, torque wrench and compressed air hoses caused by them being dropped on the floor.

Conversion times are reduced.

The risk of injury caused by compressed air hoses lying about is reduced.

① Carrying force 25 kg!



Part no.  
07395L

## Magnetic holder

for blow-out guns for compressed air, so they are always on hand at the workstation, e.g. at the lifting platform.



Part no.  
21519L

## Fillers for socket wrench applications

for the simple assignment of socket wrench inserts.

The fillers can be placed into the socket wrench inserts.



### Description

24-piece, 5 - 32 mm  
8-piece, 25 - 35 mm

Part no.  
07002L  
07001L

## Set of single hooks

for hanging-up various tools on the workshop mobile tool chest 07050L



Part no.  
07051L

## Set of double hook

for hanging-up various tools on the workshop mobile tool chest 07050L



Part no.  
07052L



## Module composition

for 3 drawers with 148 tools in premium quality.

Contains the following equipped modules:

- Z2500-1
- Z2500-2
- Z2500-3

The assortments are always delivered with adapter strips so that the inserts can also fit in existing workshop carts from different manufacturers. All tools in this set can of course also be purchased individually.



Description

Part no.

3 equipped module inserts - without tool chest - 148-piece

Z2500

## Module composition

for 4 drawers with 172 tools in premium quality.

Contains the following equipped modules:

- Z2533-1, Z2533-2, Z2533-6
- Z2566-4, Z2533-5, Z2533-7
- Z2533-6, Z2566-3
- Z2525-3, Z2550-2, Z2525-3

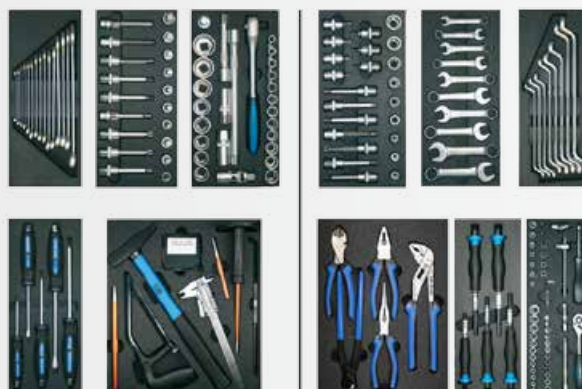

Description

Part no.

11 equipped module inserts for 4 drawers - without tool chest and loose tools - 172-piece

Z2750

## 1/1 Foam Inserts Compact

### Moulded insert

for equipping workshop mobile tool chest "compact".

Comprising 6.3 mm (1/4") and 12.5 mm (1/2") screwing tools with sockets from 4 - 32 mm, comprehensive accessories and T-profile, inner hex, Ribe and XZN tripe square sockets.



Description

Length

Width

Height

Part no.

82-piece

335 mm

495 mm

35 mm

Z2500-1



## Moulded insert

DIN CrV ■■■ YYY

for equipping workshop mobile tool chest "compact".

Comprising open-end spanners from 6 - 22 mm, combination spanners from 6 - 24 mm and double-ring spanners from 6 - 22 mm

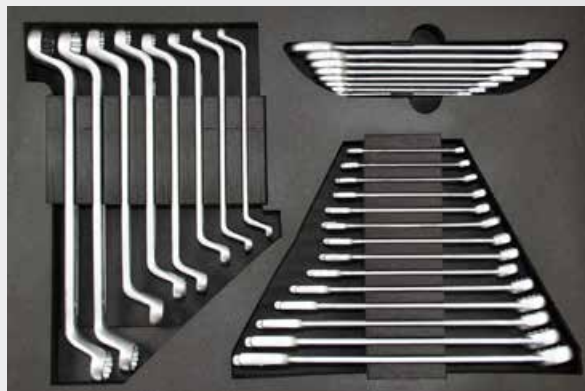

Description	Length	Width	Height	Part no.
30-piece	335 mm	495 mm	35 mm	Z2500-2

## Moulded insert

DIN ⊕ ⊖ ⊗ ⊘ CrV S2 CrV ■■■ YYY

for equipping workshop mobile tool chest "compact".

Comprising pin punches, screwdrivers with wooden handle and box-joint blade and hexagon, T-profile and inner hex Allen keys, workshop pliers, chisels and brake servicing tools



Description	Length	Width	Height	Part no.
36-piece	335 mm	495 mm	35 mm	Z2500-3

## Moulded insert

DIN CrV ■■■ YYY

for equipping workshop mobile tool chest "compact".

A large insert for a complete drawer with the following tools:

- 1 special brake calliper brush
- 2 power screwdrivers, slots 6.0 + 8.0
- 3 power screwdrivers, cross PH 1 - 2 - 3
- 1 pair of professional side cutting pliers 160 mm
- 1 pair of professional telephone pliers 200 mm
- 1 pair of professional water pump pliers 240 mm
- 1 locksmith's hammer, 500 g
- 6 parallel pin punches 2 - 8 mm in a plastic holder
- 1 centre punch 120 x 12 mm
- 1 flat chisel 200 mm



Description	Length	Width	Height	Part no.
18-piece	345 mm	495 mm	40 mm	Z2500-4

## Moulded insert



for equipping workshop mobile tool chest "compact".  
In rigid petrol and solvent-resistant moulded insert

- screwdriver, 12-piece with 2-K handles
- plain slot screwdriver 3.2x75, 5.0x75, 6.0x38, 6.0x100, 8.0x150, 9.5x200 mm
- cross-slot screwdriver 0x75, 1x75, 2x38, 2x100, 3x150, 4x200 mm



① 2/3 insert

Description	Length	Width	Height	Part no.
12-piece	333 mm	330 mm	35 mm	<b>Z2566-1</b>

## Moulded insert



for equipping workshop mobile tool chest "compact".

In rigid petrol and solvent-resistant moulded insert

- T-grip driver T10, 15, 20, 25, 27, 30, 40
- T-profile Allen key without tamperproof feature T10, 15, 20, 25, 27, 30, 40, 45, 50



① 2/3 insert

Description	Length	Width	Height	Part no.
16-piece	333 mm	330 mm	35 mm	<b>Z2566-2</b>

## Moulded insert



for equipping workshop mobile tool chest "compact".

In rigid petrol and solvent-resistant moulded insert

- 500 g hammer
- mini saw
- scriber 250 mm
- pin punches 3, 4, 5, 6, 8 mm
- flat chisel 200 mm
- cross-cut chisel 175 mm
- centre punch



① 2/3 insert

Description	Length	Width	Height	Part no.
11-piece	333 mm	330 mm	35 mm	<b>Z2566-3</b>





## Moulded insert



for equipping workshop mobile tool chest "compact".

In rigid petrol and solvent-resistant moulded insert

- brake line spanner
- special brake calliper brush
- pin punch
- brake disc gauge
- mole wrench
- special brake calliper file



① 2/3 insert

Description	Length	Width	Height	Part no.
9-piece	333 mm	330 mm	35 mm	Z2566-4

## Moulded insert



for equipping workshop mobile tool chest "compact".

In rigid petrol and solvent-resistant moulded insert

- T-grip inner hex screwdriver
- inner hex Allen key with ball-head version on the long handle



① 2/3 insert

Description	Length	Width	Height	Part no.
17-piece	333 mm	330 mm	35 mm	Z2566-5

## Moulded insert



for equipping workshop mobile tool chest "compact".

In rigid petrol and solvent-resistant moulded insert  
metalworking tools



① 2/3 insert

Description	Length	Width	Height	Part no.
8-piece	333 mm	330 mm	35 mm	Z2566-6





## Moulded insert



for equipping workshop mobile tool chest "compact".

In rigid petrol and solvent-resistant moulded insert

- Combination spanners 6, 7, 8, 9, 10, 11, 12, 13, 14, 15, 16, 17, 18, 19, 22 mm

① 1/3 insert



Description	Length	Width	Height	Part no.
15-piece	333 mm	165 mm	35 mm	Z2533-1

## Moulded insert



for equipping workshop mobile tool chest "compact".

In rigid petrol and solvent-resistant moulded insert

- double-ring spanners 6x7, 8x9, 10x11, 12x13, 14x15, 16x17, 18x19, 20x22

① 1/3 insert

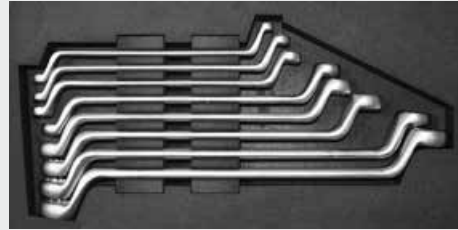

Description	Length	Width	Height	Part no.
8-piece	333 mm	165 mm	35 mm	Z2533-2

## Moulded insert



for equipping workshop mobile tool chest "compact".

In rigid petrol and solvent-resistant moulded insert

- extra-short combination spanners 10 - 11 - 12 - 13 - 14 - 15 - 16 - 17 - 18 - 19 mm

① 1/3 insert



Description	Length	Width	Height	Part no.
10-piece	333 mm	165 mm	35 mm	Z2533-3

## Moulded insert

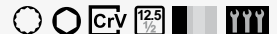

for equipping workshop mobile tool chest "compact".

In rigid petrol and solvent-resistant moulded insert

- 12.5 mm (1/2") sockets 100 mm long
- inner hexagon 6, 7, 8, 10, 12
- XZN tripe square 8, 10, 12
- 12.5 mm (1/2") sockets 53 mm long
- inner hexagon 5, 6, 7, 8, 10, 12, 14
- XZN tripe square 8, 10, 12

① 1/3 insert



Description	Length	Width	Height	Part no.
19-piece	333 mm	165 mm	35 mm	Z2533-4

## Moulded insert



for equipping workshop mobile tool chest "compact".

In rigid petrol and solvent-resistant moulded insert

- 12.5 mm (1/2") socket spanner
- E-profile E10, 11, 12, 14, 16, 18, 20, 22, 24
- 12.5 mm (1/2") screwdriver bits
- T-profile T25, 27, 30, 40, 45, 50, 55, 53
- each 53 and 100 mm long

① 1/3 insert



Description	Length	Width	Height	Part no.
23-piece	333 mm	165 mm	35 mm	Z2533-5

## Moulded insert



for equipping workshop mobile tool chest "compact".

In rigid petrol and solvent-resistant moulded insert

- 12.5 mm (1/2") lever-type ratchet wrench fine-toothed 72 teeth
- socket spanner inner hexagon 8-24, 27, 30, 32
- hinged extension 125, 250 mm
- spark plug socket 16, 21 mm



① 1/3 insert

Description	Length	Width	Height	Part no.
27-piece	333 mm	165 mm	35 mm	Z2533-6

## Moulded insert

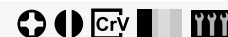

for equipping workshop mobile tool chest "compact".

In rigid petrol and solvent-resistant moulded insert

- plain slot screwdriver 6.0x100, 8.0x150
- cross-slot screwdriver 1x75, 2x100, 3x150



① 1/3 insert

Description	Length	Width	Height	Part no.
5-piece	333 mm	165 mm	35 mm	Z2533-7

## Moulded insert



for equipping workshop mobile tool chest "compact".

In rigid petrol and solvent-resistant moulded insert

- T-profile screwdriver with tamperproof feature T8, T10, T15, T20, T25, T27, T30, T40



① 1/3 insert

Description	Length	Width	Height	Part no.
8-piece	333 mm	165 mm	35 mm	Z2533-8

## Moulded insert



for equipping workshop mobile tool chest "compact".

In rigid petrol and solvent-resistant moulded insert

- hinged extension set: 6.3 mm (1/4") 50, 100, 225 mm + 10 mm (3/8") 75, 150, 225 mm + 12.5 mm (1/2") 50, 125, 250 mm
- 3-piece cardan joint set



① 1/3 insert

Description	Length	Width	Height	Part no.
12-piece	333 mm	165 mm	35 mm	Z2533-9

## Moulded insert



for equipping workshop mobile tool chest "compact".

In rigid petrol and solvent-resistant moulded insert

- circlip pliers 175 mm, for inner + outer, straight + bent



① 1/3 insert

Description	Length	Width	Height	Part no.
4-piece	333 mm	165 mm	35 mm	Z2533-10



# 1/3 Foam Inserts Compact



## Moulded insert



for equipping workshop mobile tool chest "compact".

In rigid petrol and solvent-resistant moulded insert

- 11 deep spanner sockets 6.3 mm (1/4") drive from 4-13 mm
- 10 deep spanner sockets 12.5 mm (1/2") drive from 10-24 mm



### ① 1/3 insert

Description	Length	Width	Height	Part no.
21-piece	333 mm	165 mm	35 mm	Z2533-11

## Moulded insert



for equipping workshop mobile tool chest "compact".

In rigid petrol and solvent-resistant moulded insert

- Combination ratchet wrenches with continual joint on the ring spanner, fine-toothed with 72 teeth 8, 10, 13, 15, 16, 17, 18, 19 mm



### ① 1/3 insert

Description	Length	Width	Height	Part no.
8-piece	333 mm	165 mm	35 mm	Z2533-12

# 1/4 Foam Inserts Compact

## Moulded insert



for equipping workshop mobile tool chest "compact".

In rigid petrol and solvent-resistant moulded insert

- Double open-ended spanners 6x7, 8x9, 10x11, 12x13, 14x15, 16x17, 18x19, 20x22, 24x27, 30x32



### ① 1/2 insert

Description	Length	Width	Height	Part no.
10-piece	333 mm	123 mm	35 mm	Z2525-1

## Moulded insert



for equipping workshop mobile tool chest "compact".

In rigid petrol and solvent-resistant moulded insert

- 6.3 mm (1/4") lever-type ratchet wrench fine-toothed 72 teeth
- handle with drive and output
- sockets 4, 4.5, 5-13
- PH 1, 2, 3
- plain slot 4, 5.5, 6
- T-profile with hole T10, 15, 20, 25, 30, 40
- hexagon 3 - 8 mm
- E-profile E4 - 8, 10, 11
- cardan joint
- 2 extensions
- sliding handle
- Allen key 1.5, 2, 2.5 mm



### ① 1/2 insert

Description	Length	Width	Height	Part no.
47-piece	333 mm	123 mm	35 mm	Z2525-2



## Moulded insert

CrMo 

for equipping workshop mobile tool chest "compact".

In rigid petrol and solvent-resistant moulded insert

- industrial pin punch, dampened blow  
3 - 4 - 5 - 6 - 8 mm



① 1/2 insert

Description	Length	Width	Height	Part no.
5-piece	333 mm	123 mm	35 mm	Z2525-3

## Moulded insert

 CrV CrMo 

for equipping workshop mobile tool chest "compact".

In rigid petrol and solvent-resistant moulded insert

- industrial pin punch, dampened blow  
10 - 12 - 14 - 16 mm



① 1/2 insert

Description	Length	Width	Height	Part no.
4 piece industrial punch set	333 mm	123 mm	35 mm	Z2525-4

## Moulded insert

72 

for equipping workshop mobile tool chest "compact".

In rigid petrol and solvent-resistant moulded insert

- Combination ratchet spanner, extra short,  
8, 10, 13, 15, 16, 17, 18, 19 mm



① 1/2 insert

Description	Length	Width	Height	Part no.
8-piece	333 mm	123 mm	35 mm	Z2525-5



# TOOL ASSORTMENTS





# TOOL ASSORTMENTS

666-673



▶ Tool Assortments

668-672

▶ Tool Boxes and Bags

672-673



## "Multibag XL" tool bag with "UNIVERSAL" tooling

The SW-Stahl 'Multibag XL' with 'UNIVERSAL' tooling offers craftsmen a standard range of tools for daily use.

Containing 160 parts in total, the 'UNIVERSAL' range includes 19 tools and the high-quality SW-Stahl 'Multibag XL'.

- "Multibag XL" – the practical aid for orderly storage of tools
- made from high-quality and resistant polyester fabric 600 x 600 denier
- extra large dimensions 520 x 240 x 290 mm
- 36-litre capacity and max. 25 kg full weight
- a total of 32 differemnt storage and fastening options guarantee quick access to your tools
  - 17 internal and external pockets
  - 8 internal straps for fastening and holding tools in place
  - 1 external compartment for the safe storage of saws
  - 1 lockable compartment for storing precision tools
  - additional 5 straps for fastening auxiliary materials
- includes comfortable shoulder strap, shoulder padding and removable protective cover



### Contents:

- Industrial socket spanner set, 6.3 mm (1/4"), 46-piece
- Combination spanner set, 6 - 22 mm, 15-piece
- Bit assortment 6,3 mm (1/4"), 32-piece
- Screwdriver set, 6-piece with sizes 3+4+5,5+6,5+PH1+PH2
- Safety screwdriver set, 7-piece with sizes 2,5+4+5,5+6,5+PH1+PH2 and Voltage tester
- Allen key set, inner hexagon ball head, sizes 2 - 10 mm, 8-piece
- Allen key set, T-profile without hole, sizes T10 - T50, 8-piece
- Workshop files, 200 mm, 5-piece
- Plier set, 5-piece
- Digital multimeter
- LED mini flashlight with 6 extremely bright LEDs
- Professional saw, adjustable
- Household saw with metal sawblade
- Metal sawblades 150 mm, 12-piece
- Knife with break-off blade, 18 mm, including 6 replacement blades
- Tape measure 5 m with stopper
- Folding wooden yardstick 2 m
- Aluminium spirit level 400 mm
- Hammer 500 g with hickory handle



Great price saving compared to individual purchases

Description

160-piece

Part no.

Z6000

## Tool assortment



for equipping existing workshop mobile tool chests or cases

- 8 open-ended spanners, CV-steel, DIN from 6-22 mm
- 8 double-ring spanners, CV-steel, DIN from 6-22 mm
- 11 combination spanners, CV-steel, DIN from 6-30 mm
- 17 spanner sockets, CV-steel, 1/2", 10-32 mm
- 1 cardan joint, CV-steel, 2 extensions, 125+250 mm
- 1 reversible ratchet wrench, CV-steel, 1/2", 72 teeth,
- 2 magnetic spark plug sockets, CV-steel, 16+21 mm, extra long
- 1 combination spanners, chrome-plated, insulated
- 1 side-cutting pliers, chrome-plated, insulated
- 1 edge pliers, forged, black, polished blade
- 1 water pump pliers with box-joint head,
- 4 lock-ring pliers, inner/outer locks, straight/bent
- 1 gripping pliers 250 mm, CV-steel, with wire cutter
- 1 triangular hollow scraper, 1 flat chisel, 1 cross-cut chisel
- 1 centre punch, 8 Allen keys with ball head, extra long, CV, 2-10 mm
- 1 locksmith's hammer 500 g, 1 yardstick
- 6 pin punches 2-8 mm, 1 mounting lever
- 6 wooden handle screwdrivers with hexagon
- 1 steel wire brush 3-rows
- 1 valve gauge 0.05-1.00 mm, 13-piece
- 1 brass testing lamp, nickel-plated, 6-12 Volt



Description

90-piece

Part no.

Z2300

## Werkzeugsortiment



mounting tool set in bargain package, sorted according to usage criteria, chrome-vanadium, hardness and dimensional stability according to DIN Combination spanner and 1/2" spanner sockets

- 3 units each 10 mm
- 3 units each 13 mm
- 2 units each 16 mm
- 2 units each 17 mm
- 2 units each 18 mm
- 2 units each 19 mm



① Great price saving compared to individual purchases

Description

28-piece

Part no.

Z301





## Tool case



incl. tool box 06802L (530 x 200 x 200 mm), equipped with the following tools

- 8 open-ended spanners, CV-steel, DIN 6 – 22 mm
- 8 double-ring spanners, CV-steel, DIN 6 – 22 mm
- combination pliers, chrome-plated, insulated
- side-cutting pliers, chrome-plated, insulated
- edge pliers, forged, black, polished blade
- water pump pliers with box-joint design, CV-steel
- triangular hollow scraper, flat chisel, cross-cut chisel
- centre punch
- 8 ball-type inner hexagon keys, extra long, chrome-vanadium, 2 – 10 mm
- locksmith's hammer 500 g, yardstick
- 6 pin punch 2 – 8 mm, mounting lever
- 6 screwdrivers with wooden handle and hexagon
- wire brush, 3-row
- valve gauge 0.05 – 1.00 mm, 13-piece
- brass testing lamp



**Description**  
51-piece

**Part no.**  
Z2200

## Tool kit



with three trays and lid compartment, lockable, central locking seals the drawers when the lid is closed.

Top handle and robust side handles for safe transport.

- Inner dimensions of the lid compartment: 520 x 210 x 55 mm
- Inner drawer dimensions: 540 x 195 x 45 mm

Equipped with 3 tool modules and 108 tools in professional quality, e.g.

- Magnetic spark plug bits 16 + 21 mm
- 32 colour-coded bit inserts with various profiles
- 9 internal hex with spheroid head
- Offset wrench 1.5 - 10 mm
- 28 full-size socket spanners, hex, 4 - 32 mm
- reversible ratchets and extensions 1/4" + 1/2"
- Impact screwdriver, slot, Phillips and hex
- Side cutter, telephone and water pump pliers
- 15 combination wrenches 6 - 22 mm
- 4 double open-ended ring ratchet wrenches



① **High-quality product!**

Description	Length	Width	Height	Part no.
Equipped with 108 tools	560 mm	230 mm	290 mm	<b>06816L</b>
Case, empty	535 mm	290 mm	225 mm	<b>06815L</b>
3 empty inserts				<b>06816L-EINLAGE</b>

## Roll-up bag for passenger car tools



Equipped with open-end spanners, water pump pliers, combination spanner, screwdrivers, spark-plug key and brush, testing lamp



**Description**  
15-piece

**Part no.**  
07400SB

## Tool assortment



Inc. tool box 06802L (530 x 200 x 200 mm)

- 12 open-ended spanners 6 x 7 mm -27 x 32 mm
- 15 combination spanners 6 - 30 mm
- 1 Allen key set with ball head (9-piece)
- 1 socket spanner set 12.5 mm (1/2") (27-piece)
- precision valve gauges 20 blade
- 6 screwdrivers with wooden handles
- 4 circlip pliers
- 1 flat chisel
- 6 pin punches
- 1 brush
- 1 locksmith's hammer 800 g
- 1 tape measure
- 1 brass padlock
- car light tester brass 120 mm
- professional Rabitz pliers DIN 9242A, 250 mm
- professional side-cutting pliers 160 mm



**Description**  
90-piece

**Part no.**  
Z4200

## Truck servicing bag



in professional quality, for mechanics and electrics

- open-end spanner set from 6 - 32 mm
- water pump pliers 240 mm
- combination pliers 180 mm
- locksmith's hammer 500 g
- cable lug pliers
- brass testing lamp
- hexagon set from 3 - 10 mm
- 2 plain slot screwdrivers
- 2 cross-slot screwdrivers
- assortment of cable lugs
- assortment of cable ties



**Description**  
30-piece

**Part no.**  
07420L

## Professional roll-up bag for bikes



with belt loop, 6,3 mm (1/4") hexagon drive

- 1 handle with magnetic bit holder and quick lock
- 1 extension 125 mm with magnetic bit holder
- 4 spanner sockets with magnet 6, 8, 10, 13 mm
- plain slot bit 5.5 mm
- cross-slot bits PH1, PH2, PH3
- Pozidriv bit PZ2
- hexagon socket bits 3, 4, 5, 6 mm
- T-profile bits T10, T15, T20, T25, T30, T40, T45



**Description**  
22-piece

**Part no.**  
07450L





## Ratchet wrench set



Chrome vanadium S2 special steel.  
The S-type shaped ratchet wrench has a 6.3 mm (1/4") hex bit drive and a 6.3 mm (1/4") square drive for socket wrench with an insert stop, fine toothed 72 teeth, left/right reversible.

- extension in length 50 mm
- cardan joint
- bit holder
- T-profile bits 10-15-20-25-27-30
- inner hex bits 3-4-5-6-8 mm
- plain slot bits 4,5-5,5-7 mm
- cross slot bits PH1-PH2-PH3
- Pozidrive bits PZ1-PZ2-PZ3
- socket wrench inserts 6.3 mm (1/4")



### Description

33-piece,  
5-6-7-8-9-10-11-12-13 mm

### Part no.

**36015L**

## Tool Boxes and Bags

### "Multibag XL" tool bag



"Multibag XL" – the practical aid for orderly storage of tools

- made from high-quality and resistant polyester fabric 600 x 600 denier
- extra large dimensions 520 x 240 x 290 mm
- 36-litre capacity and max. 25 kg full weight
- a total of 32 differemmnt storage and fastening options guarantee quick access to your tools
  - 17 internal and external pockets
  - 8 internal straps for fastening and holding tools in place
  - 1 external compartment for the safe storage of saws
  - 1 lockable compartment for storing precision tools
  - additional 5 straps for fastening auxiliary materials
- includes comfortable shoulder strap, shoulder padding and removable protective cover



### Part no.

**07025L**

### Tool case



Sheet steel, hammer blue-enamelled, 5-piece each, extendable



Length	Width	Heigth	Part no.
430 mm	200 mm	200 mm	<b>06801L</b>
530 mm	200 mm	200 mm	<b>06802L</b>

### Tool case



plastic, with removable insert



Length	Width	Heigth	Part no.
390 mm	210 mm	190 mm	<b>06805L</b>



## Aluminum case

with tool panel and 6-division compartment



Length	Width	Height	Part no.
460 mm	350 mm	160 mm	06810L

## Roll-up bag for tools

made of artificial leather

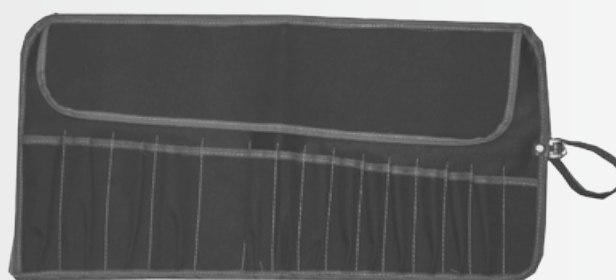

Description	Part no.
15 compartments, empty, 650 x 330 mm	07302L
10 compartments, empty, 465 x 320 mm	07301L

# WORKSHOP EQUIPMENT





# WORKSHOP EQUIPMENT

## 674-697



- ▶ Worklamps and Handlamps 676-679
- ▶ Inspection Mirrors / Magnetic Lifter 679-681
- ▶ Engine and Transmission Jacks 681-686
- ▶ Hydraulic Jacks / Jack Stands 686-689
- ▶ Car Creepers 690-691
- ▶ Body and Seat Protections 691-692
- ▶ Workshop general 692-694
- ▶ Vices 695
- ▶ Hydraulic Press 695
- ▶ Air Compressor 695-696
- ▶ Garage Furniture 697



## Battery workshop lamp 3W COB LED

- powerful, flicker-free light by 3W LED COB
  - COB LED's: COB (Chips on Board) modules consisting of several LED chips
  - advantage: supplied with power, these result rather a luminous surface instead of several individual light points
- low heat generation and uniform light distribution
- with integrated magnet and suspension hook, it can be fixed almost everywhere
- foldable frame
- integrated spotlight
- compact design for hard-to-reach places
- incl. USB charging cable with adapter for socket and cigarette lighter



Part no.  
S9780

## Battery workshop lamp 2W COB LED

- powerful, flicker-free light by 2W LED COB
  - COB LED's: COB (Chips on Board) modules consisting of several LED chips
  - advantage: supplied with power, these result rather a luminous surface instead of several individual light points
- low heat generation and uniform light distribution
- with integrated magnet and suspension hook, it can be fixed almost everywhere
- foldable frame
- integrated spotlight
- compact design for hard-to-reach places
- incl. USB charging cable with adapter for socket and cigarette lighter



Part no.  
S9781

## Battery workshop lamp 1.5W COB LED

- powerful, flicker-free light by 1.5W LED COB
  - COB LED's: COB (Chips on Board) modules consisting of several LED chips
  - advantage: supplied with power, these result rather a luminous surface instead of several individual light points
- low heat generation and uniform light distribution
- with integrated magnet and suspension hook, it can be fixed almost everywhere
- foldable frame
- integrated spotlight
- compact design for hard-to-reach places
- incl. USB charging cable with adapter for socket and cigarette lighter



Part no.  
S9782

## Garage lamp



universal, 230 V with ballast in the handle

- CE protective insulation
- 50 Hz
- 5 m cable length



Part no.  
**S9710**

## Garage light



practical, cordless garage light for repairs and servicing

- 60 extremely bright and energy-saving LEDs
- at the same time surface-emitting diode (51 LEDs) and spotlight (9 LEDs)
- magnetic clamp and pivoted hanging for flexible operating positions
- storage batteries with a duration of 4 hours integrated
- 230 V network adapter and 12 V connection included



Part no.  
**S9725**

## Engine Compartment Light



- extremely bright illumination of the entire engine compartment due to the high-performance 40W SMD LED technology
- 2-Stage adjustable lighting
- telescopic support extendible from approx. 112 to 188 cm
- space-efficient storage (Light 89,5 x 2,7 cm; telescopic support 112 x 10 x 6 cm)
- very low weight (1.000 g incl. telescopic support)
- Luminous flux 800 Lm (Stage 1) and 1.500 Lm (Stage 2)
- including 2 pcs. 3.7V lithium ion accumulators, USB charge cables with adapter for plug socket, charge cables for cigarette lighter and 2 magnetic hooks for fixing the light on steel surfaces



Description

Part no.

**S9745**

Extension cable

**S9745-K**

## 4-leg tripod



for energy-saving lamp work item S9750

- spec. 2-pin record
- Height adjustment 162-265 cm
- Feet with rubber caps
- including Shot



Part no.  
**S9752**





## LED mini flashlight



ideal for vehicle inspections, service consultation at the vehicle or repairs where space is tight.

- 6 extremely bright LEDs
- pocket clip for the overall or breast pocket
- water-repellent



① Incl. 3 x AAA batteries

Part no.

**S9730**

## LED electric torch



with aluminium housing, reflector and lens focussed beam.  
On/off switch on rear



① Incl. 3 x AAA batteries

Part no.

**S9811**

## LED telescopic torch



with magnet

- extendable 16.5 cm - 54.5 cm
- swan neck
- torch head can be turned through 360°
- magnetic torch head
- load-bearing capacity approx. 2 kg
- incl. 4 LR44 batteries



Part no.

**30022SB**

## LED light pen



quantum light, extremely bright, precise and handy.

- incl. battery
- battery life ca. 10,000 hours
- water-repellent



Part no.

**S9810**

## LED battery head lamp 2W COB



- powerful, flicker-free light with 2W COB LED
- low heat generation and uniform light distribution
- dimensions approx. 100 x 50 x 40 mm
- 2-level adjustable lighting
- excellent fit with adjustable rubber band
- can be used under cap, helmet or other head gear
- luminous flux 100 Lm (level 1) or 180 Lm (level 2)
- Integrated 3.7V / 1800 m Ah Li-Ion battery
- incl. USB-charging cable with adapter for socket



① Incl. USB-charging cable with adapter for socket.

Part no.

**S9713**

## LED-battery head lamp display-box

display-box equipped with 12 LED-battery head lamps S9713.



Description  
12-piece

Part no.  
S9714

## LED head lamp

with 12 diodes, high light output, optimum fit thanks to adjustable elastic.  
Also easy to wear with cap, helmet or other headgear.



ⓘ Incl. 3x AAA micro batteries

Part no.  
S9711

## Inspection Mirrors / Magnetic Lifter

### LED telescope inspection mirror

ideal for visual inspections under the vehicle to look for oil loss, corrosion (e.g. rust) etc.

- with telescopic handle 270 to 880 mm, infinitely adjustable
- mirror size 41 x 62 mm
- mirror angle adjustable

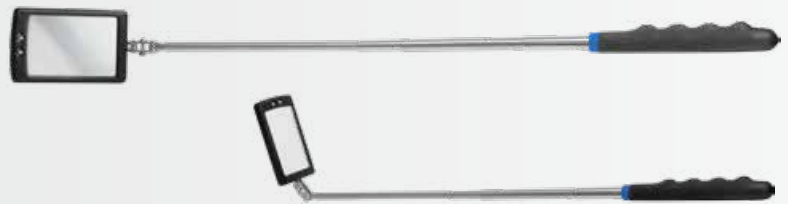

ⓘ Incl. batteries

Part no.  
30017SB

### Telescopic inspection mirror

with clip for the overall pocket, can be extended to 476 mm, 30 mm mirror diameter



ⓘ With double joint

Part no.  
30012SB

### LED magnetic lifter and mirror set

in a practical storage bag

- Magnetic lifter with LED lighting,
- extendable up to 665 mm, carrying force 450g
- Magnetic lifter,
- extendable up to 665 mm, carrying force 3500g
- 3 mirror attachments for LED magnetic lifters
- 21 - 31 - 38 mm diameter
- incl. 3 x button cell LR41



Description  
5-piece

Part no.  
30016L



## Magnetic and servicing mirror set



with LED light, for fixed and flexible use

- Standard length magnetic lifter approx. 640 mm
- with extension 1075 mm



ⓘ **Necessitates 3 x AAA batteries which are not included!**

Part no.  
**30009L**

## LED tweezers product range



150 mm long

- implementation in straight, curved and "extra pointed" design
- extra bright LED
- in practical retention folder
- ideal for poorly illuminated areas e.g. in devices, dashboards, engine compartment, machines or with soldering work (e.g. with item no. 61805SB)
- operation with button cell LR41



ⓘ **Cell battery LR41 is included!**

Description  
3-piece

Part no.  
**S3129**

## Pincers



- stainless steel
- straight version 130 mm
- pointed ends for precise gripping
- for precision mechanical work e.g. when soldering instrument lighting etc.



Length  
130 mm

Part no.  
**30021L**

## Claw gripper



flexible, with spring system for gripping screws and nuts at spots that are difficult to access

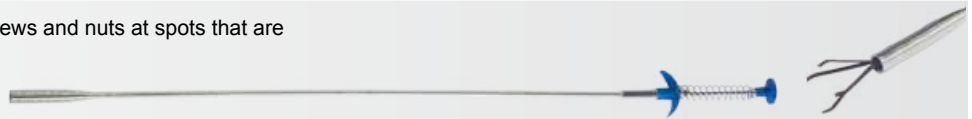

Length  
620 mm

Part no.  
**30000L**

## Claw gripper



flexible, with spring system for gripping screws and nuts at spots that are difficult to access

Equipped with additional magnet for increasing the carrying load to a maximum of 800g.

- claw opening 23 mm

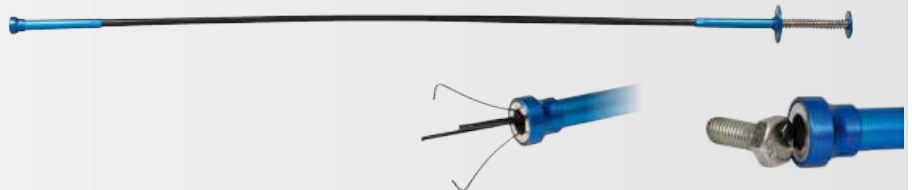

Length  
700 mm

Part no.  
**30019L**



## Telescopic magnetic lifter

with clip for the overall pocket, tip for cleaning and adjusting windscreen washer nozzles

- extendable from 150 - 670 mm
- Head diameter 7.5 mm
- up to 200 g



Description	Part no.
150 - 670 mm	30003L
165 - 650 mm	30002L

## Magnetic lifter

flexible



Description	Length	Part no.
500 g carrying force with extra thin tip - just 6 mm diameter	500 mm	30015L
1.500 g carrying force for larger components	540 mm	30020L

# Engine and Transmission Jacks

## Engine bridge

For safe work on belts, gearboxes, etc.

- Made of stable square tubing
- For flexible widths
- Holding hooks with 16 mm threaded rods
- With rubber padding to protect the mudguards
- Chain length 900 mm
- Assembly dimensions 1010 mm to 1520 mm



Description	Part no.
1 chain, 300 kg load capacity	20303L

## Engine bridge

for assembling and disassembling the engine and gears

- made from a stable four edged pipe
- long hole (700 mm ) for flexible width setting
- holding hook with a 20 mm threaded rod
- with rubber protectors to protect the mudguard
- chain length 900 mm
- mountable from 750 - 1.450 mm



Description	Part no.
2 chains, 500 kg load capacity	20305L

## Engine bridge

to support the engine when removing the gearbox.

Suitable for:

- VW T5

Used equivalent to:

- VW OE no. 10-222A/23 support arms

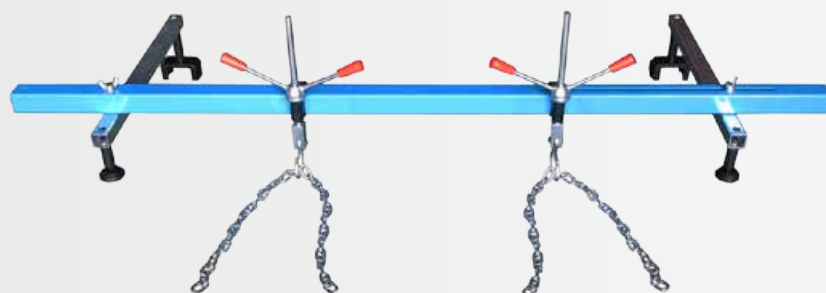

Part no.
20304L





## Engine support bar



for pulling the engine and gearbox when exchanging the coupling or gearbox.

VW

Suitable for:

- VW T4 (4 and 5 cylinder models).

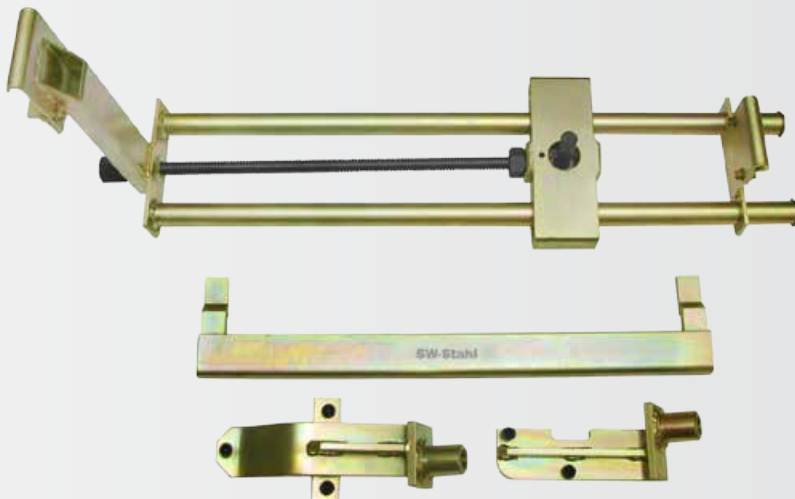

Part no.  
20308L

## Engine support bar



- Variable length from 630 to 960 mm

It is not possible to use typical engine bridges on many new vehicles, as the mudguards fall away at a slant or are made of plastic. The universal engine support bar provides the engine with secure support from below.



Part no.  
26596L

## Engine support crossmember bar



The universal engine support tie-bar securely holds the engine from below as soon as the side engine bearings are dismantled. The usual engine bridge is no longer required. When working on the toothed belt, water pump or auxiliary drive, a free access from above is now possible.

- the two adjustable mounting hooks securely hold the motor support beam at the vehicle floor.
- height-adjustable support plate for targeted lowering or lifting of the motor.
- the rear support arms can be positioned independently of each other by means of a hinge. Wide long holes in the arms help to find the best position for the support.
- incl. A receptacle for standard transmission drives. This means that the beam can also be installed very simply by one person.

Features:

- maximum support load: 250 kg
- variable length from 374 mm to 1,170 mm
- telescopic arm: 230 mm extendable
- support arms: pivoting 360° rotatable, 122 mm long holes



Part no.  
26597L

⚠ Do not use with pneumatic impact wrenches!

## Engine support bar

for fast and professional mounting and removal of the engine suspension when working on tensioning roller, toothed belt and water pump.

No cumbersome and time-consuming mounting of engine bridges that cannot be used any on many vehicles for structural reasons.

The large number of adapters for the basic unit allows work to be carried out on almost all current vehicles.

- Comparable tools at Ford OEM 303-1554

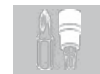

## Extension plate

for use with the base device 26510L.

Allows work on the gearbox of a Ford Fiesta from '09, as well as 1.0 l petrol and 1.4 l diesel engines in Citroën C1, Peugeot 107 and Toyota Aygo

Application:

1. Replace retaining plate on the base device 26510L
2. Fit model-specific adapter

- ⓘ Suitable for gear box operations with extension 26505L



Citroën  
Toyota  
Peugeot  
Ford

Description	Part no.
Extension plate for gear box operations	26505L
Adapter toothed belt + gear box Ford Fiesta from '09	26535L
Adapter toothed belt + gear box Citroën C1, Peugeot 107, Toyota Aygo	26554L

## Engine support bar

for use with basic unit 26510L



Seat  
VW

Description	Part no.
Support bar for VW Sharan, Galaxy, Seat Alhambra	26520L
Support bar for VW Golf IV, New Beetle, Audi A3, Škoda Octavia, Seat Leon, Toledo	26521L
Support bar for VW Golf V, Audi A3 from '04, Seat Altea, Toledo, Touran, Škoda Octavia from '04, Seat Leon from '05	26522L
Support bar for VW Lupo 3l	26523L
Support bar for VW Polo, Škoda Fabia, Seat Ibiza from 2002	26524L
Support bar for VW Lupo 4 Zylinder, VW Fox	26526L
Support bar for VW Passat 2.0	26527L
Support bar for Škoda Octavia 2.0tdi from '07 VW Passat 3C 2.0TDI from 08/05, Tiguan from '07	26528L
Support bar for VW Up, Seat Mii, Škoda Citigo from '12	26557L
Support bar for VW Golf VII, Seat Leon, Škoda Octavia, Audi A3 from '12	26558L
Support bar for VW T5, Sharan II, Passat, Seat Alhambra from '10	26559L

## Engine support bar

for use with basic unit 26510L



Opel

Description	Part no.
Support bar for Opel Zafira B (Petrol) from '05	26560L
Support bar for Opel Vectra C (Diesel) from '05	26561L
Support bar for Opel Vectra C 1.6 - 1.8l (Petrol) from '02	26562L
Support bar for Opel Vivaro	26564L
Support bar for Opel Zafira A (Petrol), Astra 1.6l (Petrol) from '99	26563L
Support bar for Opel Corsa D petrol and diesel	26565L



## Engine support bar



for use with basic unit 26510L

Ford



① Suitable for gear box operations with extention 26505L

Description	Part no.
Support bar Ford Focus from '98 without C-max	26530L
Support bar Ford Focus C-max from '03, Volvo S50 / V50	26531L
Support bar Ford Fusion, Fiesta	26532L
Support bar Ford Fiesta Diesel from '05	26533L
Support bar Ford S-max from '06	26534L
Support bar toothed belt + gear box Ford Fiesta from '09	26535L
Support bar Ford Ka / Fiat 500, Panda 1200 from '04	26536L
Support bar Ford from '10	26537L

## Engine support bar



for use with basic unit 26510L

Peugeot  
Citroën



① Suitable for gear box operations with extention 26505L

Description	Part no.
Support bar Peugeot 806, Citroën Jumpy	26543L
Support bar Peugeot 206 + 307	26540L
Support bar Peugeot 406, Partner, Citroën Berlingo	26541L
Support bar Peugeot 407, C5 from '09	26542L
Support bar Peugeot 807, Citroën C8	26544L
Support bar Peugeot 607	26545L
Support bar Peugeot Boxer, Citroën Jumper, Fiat Ducato	26546L
Support bar Peugeot Boxer from '07	26547L
Adapter Peugeot 308 2.6l Petrol	26548L
Adapter Peugeot 207 1.6l HDI / 1007 1.4l Diesel	26549L
Support bar Citroën C4	26550L
Support bar Citroën C5	26551L
Support bar Citroën Picasso, Xantia, Xsara, ZX	26552L
Support bar Citroën C2, C3 1.4l	26553L
Adapter toothed belt + gear box Citroën C1, Peugeot 107, Toyota Aygo	26554L
Adapter Citroën DS5 from '12	26555L
Adapter Citroën C5 from '11	26556L

## Engine support bar



for use with basic unit 26510L

Renault



Description	Part no.
Support bar Renault Mégane I	26513L
Support bar Renault Mégane II	26516L
Support bar Renault Kangoo 1,4, Clio II 1,2 from 2004	26512L
Support bar Renault Espace III	26511L
Support bar Renault Laguna 1.8	26514L
Support bar Renault Scénic II	26515L

## Engine support bar

for use with basic unit 26510L



Hyundai



Description	Part no.
Support bar Hyundai I10 from '12	26566L
Support bar Hyundai I20 from '10	26567L
Support bar Hyundai I30 from '12	26568L
Support bar Hyundai I40 from '12	26569L

## Engine support bar

for use with basic unit 26510L



Fiat

Description	Part no.
Support bar Fiat Punto from '06, Mito	26570L
Support bar Fiat Stilo 1.6 (Petrol)	26571L
Support bar Fiat Doblo	26572L
Support bar Fiat Punto 1998 - 2005	26573L
Support bar Fiat Multipla	26574L
Support bar Fiat Doblo (Diesel)	26575L
Support bar Alfa 159 (Diesel) from 2006	26580L

## Engine support bar

for use with basic unit 26510L



Suzuki

Description	Part no.
Support bar Suzuki Swift	26590L

## Engine stand

Rotatable through 360° and lockable in 8 positions

- Casters with ball bearings
- The angle of the 4 attachment points and the distance between them can be adjusted
- The support plate can be turned so that the engine can be turned



Description	Rated load capacity	Carrying load	Part no.
Standard version	450 kg	450 kg	20301L
XL version	570 kg	570 kg	20302L

## Gearbox lifter

for the safe fitting and removing gearboxes, engines, clutches

- 4 casters with ball bearings
- Heavy-duty version
- Special deep working range
- Tilt angle and position of base plate can be adjusted
- Horizontal +/- 40 mm
- Tilt angle -10°/20°
- 420 mm support rails with support chains for safe tensioning, distance adjustable from 200 - 320 mm
- Fast lifting thanks to hydraulic foot pump
- upper piston rod with diameter 29,35 mm and thread M30 x 1.5 for the gear box holding device



Rated load capacity	Carrying load	Lifting height max.	Lifting height min.	Part no.
500 kg	500 kg	1770 mm	855 mm	20307L

## Workshop crane

Multi-purpose workshop crane for weights of up to 1000 kg. The crane arm is adjustable in length and has a chain with safety hook. The 2 moving casters ensure maximum flexibility even under load. Space-saving storage thanks to fold-away supports.

### Technical data:

- max. lifting capacity: 250 - 1000 kg
- max. lifting arm length: 902 - 1169 mm
- max. lifting height: 2019 - 2248 mm
- lifting cylinder with safety valve
- can be folded away for space-saving storage and transport, can be completely dismantled if necessary
- 2 casters, 2 fixed wheels made of steel
- including chain with safety hook

Dimensions when folded (LxWxH) 600 x 790 x 1560 mm  
 Height of the frame 160 mm  
 Base frame (LxW) 1570 x 850 mm



### Carrying load

1000 kg

### Part no.

20310L

## Engine alignment support bar

for the precise positioning of the engine during fitting and removal. Makes it easier to attach the engine to the gearbox by balancing out the centre of gravity.

- Inner dimension 490 mm
- adjustment dimension +/- 210 mm
- two chains à 500 mm
- crank 160 mm



### Carrying load

350 kg

### Part no.

20315L

# Hydraulic Jacks / Jack Stands

## Scissors-type jack

with crank

- lifting power: 100 - 360 mm
- heavy load: 1500 kg



### Carrying load

1500 kg

### Lifting height min.

100 mm

### Lifting height max.

360 mm

### Part no.

22201L

## Trolley Jack

- carrying load 2,000 kg
- single Lifting height: 135 - 335 mm
- with casters and safety valve



### Carrying load

2000 kg

### Lifting height min.

135 mm

### Lifting height max.

335 mm

### Part no.

20700L

## Trolley Jack

Racing look

- hydraulic double piston mechanism
- quick lifting - effortless
- very low in weight but sturdy
- with rubber pad on bearing area
- with rod protection on piston rod
- lifting height: 95 - 440 mm
- carrying load: 2000 kg
- made of aluminum
- for lowered vehicles



Carrying load	Lifting height min.	Lifting height max.	Part no.
2000 kg	95 mm	440 mm	20740L

## Trolley Jack

- hydraulic double piston mechanism
- quick lifting - effortless
- very low in weight but sturdy
- with rubber pad on bearing area
- with rod protection on piston rod
- lifting height: 140 - 520 mm
- carrying load: 3000 kg
- wheels made of steel



Carrying load	Lifting height min.	Lifting height max.	Part no.
3000 kg	140 mm	520 mm	20731L

## Trolley Jack

- hydraulic double piston mechanism
- quick lifting - effortless
- very low in weight but sturdy
- with rubber pad on bearing area
- with rod protection on piston rod
- lifting height: 98 - 535 mm
- carrying load: 3000 kg



Carrying load	Lifting height min.	Lifting height max.	Part no.
3000 kg	98 mm	535 mm	20741L

## Trolley Jack

made of aluminium

Hydraulic, with rubber pad contact surface, steel wheels and transport handle



ⓘ **Extremely light**

Carrying load	Lifting height min.	Lifting height max.	Part no.
1500 kg	125 mm	340 mm	20710L



## Hydraulic jack



with safety valve.



Carrying load	Lifting height min.	Lifting height max.	Part no.
2000 kg	155 mm	295 mm	20601L
5000 kg	215 mm	430 mm	20602L
12000 kg	215 mm	415 mm	20605L
20000 kg	240 mm	470 mm	20606L

## Trolley Jack



for the simple lifting of the vehicle without touching the chassis or body.

- with four trolley jacks the vehicle can be turned through any angle (360°).
- carrying force 680 kg / trolley jack, 2.720 kg when four trolley jacks are used
- foot-pedal operation
- suitable for tyres up to 225 mm wide
- rim diameter maximum 600 mm
- every trolley jack has 4 casters
- lifting height 135 - 390 mm



Description	Carrying load	Tyre width max.	Part no.
Single trolley	680 kg	225 mm	20720L
Replacement caster unit			20721L

## Trolley Jack



for simple vehicle lifting without touching the chassis or body.

- the use of four trolley jacks allows you to position and turn the vehicle as required
- load-bearing capacity 680 kg / 2,720 kg when four trolley jacks are used
- hydraulic cylinder operated by foot pedal
- suitable for tyres 300 mm wide
- maximum tyre diameter 800 mm / rim diameter 21"
- every trolley jack is equipped with 4 plastic casters with a diameter of 100 mm
- lifting height 135 - 390 mm



Description	Carrying load	Tyre width max.	Part no.
Single trolley complete	680 kg	300 mm	20723L
Replacement caster unit			20721L

## Car manoeuvring shell set



for manoeuvring vehicles where space is very tight e.g. in presentation rooms, showrooms or for vehicles which can only be pushed following an accident or engine damage.

- 4 solid metal casters with ball bearings (diameter 88 mm) per manoeuvring shell
- load-bearing capacity each shell: max. 450 kg
- max. tyre width: 380 mm



Description	Part no.
2-piece	20724L
Replacement caster unit	20724L-1



## Drive-on ramp for passenger cars



permissible up to tyre size 185 mm

- blue coated
- steel
- carrying force 2000 kg / pair



Stroke height	Length	Width	Part no.
210 mm	950 mm	290 mm	<b>20800L</b>

## Drive-on ramp for passenger cars



collapsible, 2-part design, ramp length approx. 2000 mm, ramp width 250 mm – stable and anti-slip as a result of the perforated surface and pronounced crosswise grooves

- for loading quad bikes, motorbikes, lawnmowers etc.
- collapsed, the unit can be used as a drive-on ramp for vehicles
- maximum load per ramp: 1100 kg (collapsed L=900 mm H=170 mm) 350 kg (fully extended L=2000 mm H=100 mm)
- saves space, as it can be collapsed
- the carry handle makes it easy to transport
- sturdy steel construction



① 1 pair, versatile and suitable for mobile application

Length	Width	Part no.
2000 mm	250 mm	<b>20810L</b>

## Jack stand



available as single unit or as pair



Description	Rated load capacity	Carrying load	Height min./max.	Part no.
1 piece	3000 kg	3000 kg	320 / 490 mm	<b>20400L</b>
1 pair (2 piece)	3.000 kg	3000 kg	320 / 490 mm	<b>20405L</b>

## Jack stand



available as single unit or as pair



Description	Rated load capacity	Carrying load	Height min./max.	Part no.
1 pair (2 piece)	2 t	2000 kg	265 / 420 mm	<b>20455L</b>
1 piece	2 t	2000 kg	265 / 420 mm	<b>20450L</b>
1 pair (2 piece)	3 t	3000 kg	280 / 420 mm	<b>20465L</b>
1 piece	3 t	3000 kg	280 / 420 mm	<b>20460L</b>
1 pair (2 piece)	6 t	6000 kg	385 / 600 mm	<b>20475L</b>
1 piece	6 t	6000 kg	385 / 600 mm	<b>20470L</b>





## Creepers



made of plastic, ergonomically formed, with utility boxes for consumables at the side.

- 6 casters
- 130 kg capacity



ⓘ Improved, more stable version!

Description	Part no.
Creepers	<b>20950L</b>
Replacement Caster unit	<b>20950L-Rolle</b>

## Creepers



with steel frame and cushion, 6 ball-bearing wheels with rubber tyres

- load: 120 kg



Part no.  
**20960L**

## Creepers for sitting or lying down



with double-bearing casters

- hard-wearing artificial leather cover
- can be locked in sitting or lying position
- Size: 120 x 42 cm
- lying height: 120 mm
- load 135 kg

Seat:  
320 x 310 mm (with open-back)  
480 x 310 mm (with folded back)

Lying area:  
900 x 310 mm (without backrest)  
1060 x 310 mm (incl. backrest)

Back:  
160 x 310 mm

Seat height: 445 mm



Part no.  
**20910L**

## Stool on wheels



made of plastic, black, with 4 casters  
Base can be used as tool tray

- Seat height 290 mm
- Capacity up to 160 kg



Part no.  
**20915L**

## Multi-purpose frame

with rubber-coated supports for the placement of body parts e.g. during window or painting work, or for transporting large bulky vehicle parts.

The height and length adjustment possibilities makes the frame suitable for almost any vehicle.

Can be collapsed for compact storage after use.

- With 4 sturdy casters, 2 of which can be locked in place
- Load capacity up to approx. 100 kg
- Width from 200 mm to 1380 mm
- Height from 840 mm to 1320 mm
- Length 855 mm (not adjustable)



### Carrying load

100 kg

### Part no.

20340L

## Knee pad

with compartment for consumables, made of solvent-resistant foam. 2-colour for better distinction of standard parts, with practical handle

Overall dimensions: 475 x 310 x 35 mm  
Consumables compartment: 200 x 100 mm



### Length

475 mm

### Width

310 mm

### Height

35 mm

### Part no.

07370L

# Body and Seat Protections

## Wing protector

with magnet, for protection against dirt and damage to the paintwork during work on the engine



### Length

600 mm

### Width

800 mm

### Part no.

S3232

## Wing protector

- Black imitation leather, foam backing
- Optimum protection of customers' vehicles against scratches, bumps, oil and other soiling
- Front can simply be wiped off / cleaned



### Description

with magnetic adhesion

### Material

Imitation leather

### Part no.

07309L

## Wing protector

- Black imitation leather, foam backing
- Optimum protection of customers' vehicles against scratches, bumps, oil and other soiling
- Front can simply be wiped off / cleaned



ⓘ **Ideal for aluminum or plastic fender!**

### Description

with loops

### Material

Imitation leather

### Part no.

07315L





## Front protector

for the vehicle front

- with headlight opening
- made of high-quality synthetic leather and foam coating on the inside
- Individually adjustable width with Velcro fastener in the middle
- suitable for many personal vehicles and vans, e.g. all VAG vehicles up to T5, BMW, Mercedes-Benz, Ford, etc.
- Programming or servicing can be performed with the headlights switched on; the permeable protective covering allows the heat from the headlights to escape.



Alfa Romeo  
Audi  
BMW  
Citroën  
Ford  
Mercedes-Benz  
Nissan  
Opel  
Seat  
Škoda  
VW  
Renault

① Since 2013 the front protector is a part of the workshop ISO-testing!

Material

Imitation leather

Part no.

07316L

## Universal seat cushion protector

for the driver seat

- Black imitation leather
- Protective cover for all common vehicle seats
- Individual seat protector with integrated head restraint protection and slit on one side for side airbag (driver seat)
- Optimum protection for customers' vehicles
- Seams are reinforced with imitation leather



Material

Imitation leather

Part no.

07308L

## Anti-slip-mat

For universal use in various application areas. Special adhesion - everything stays in place.

- the mat can be cut with a scissors to any desired size
- tear and shock resistant, easy to clean
- with a thickness of 1 mm



Description

ca. 120 x 60 cm

Part no.

07305L

# Workshop general

## Garage order folder

- With pocket for keys and vehicle papers on the back
- Extra-wide fold for larger filling capacity
- With pen-holder tag
- Cotton cord for hanging up
- DIN A4



Description

Black

Blue

Part no.

07311L

07312L

## Tool and device strip



magnetic, approx. 500 mm long



① **Delivered without tools!**

Part no.  
**07355L**

## Placement shell set



with magnet for fixing on all metallic surfaces.

- 150-210-310 x 120 mm

Delivery without workshop mobile tool chest



① **Also ideal for utilization with workshop vehicles maxi and compact**

Description	Part no.
3-piece	<b>07005L</b>
3-piece with two moulded inserts	<b>07020L</b>
2 moulded inserts	<b>07015L</b>

## Placement shell set with foamed material inserts for cans



Magnetic shell set 07005L, 3-piece, together in a set with two moulded inserts 07015L

- For the storage of 250ml / 400ml + 500ml cans



Description	Part no.
3-piece with two moulded inserts	<b>07020L</b>

## Consumables dish



magnetic, made of stainless steel, for holding screws, nuts etc.



Description	Part no.
approx. 290 x 270 mm	<b>07357L</b>

## Consumables dish



magnetic, made of stainless steel, for holding screws, nuts etc.



Description	Part no.
approx. 150 mm diameter	<b>07356L</b>
approx. 290 x 270 mm	<b>07357L</b>





## Consumables dish



with magnetic clamp, diameter ca. 150 mm.  
The one-sided higher shape makes it possible to store non-magnetic parts made of aluminium, brass and stainless steel for the first time, making it indispensable at any workstation.



**Description**  
approx. 150 mm diameter

**Part no.**  
**07358L**

## Permanent magnet



For magnetising and demagnetising screwdriver blades, tweezers, etc.  
Housing made of high-quality ABS plastic, unbreakable, cadmium-free.

The tools are slowly fed through the rectangular opening (+) for magnetisation through the stepped opening (-) for demagnetisation.



**Part no.**  
**30014L**

## Clamping rail



for 15 sockets with 6.3 mm (1/4") drive



**Length**  
412 mm

**Part no.**  
**05400-LEISTE**

## Clamping rail



for 15 sockets with 10 mm (3/8") drive



**Part no.**  
**05500-LEISTE**

## Clamping rail



for 15 sockets with 12.5 mm (1/2") drive

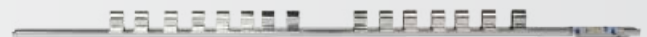

**Part no.**  
**05600-LEISTE**

## Adhesive tape dispenser



for rolls of adhesive tape 50 mm



**Part no.**  
**S3220**

**Aluminium protective jaws**



for vices

with magnetic attachment and prism guide

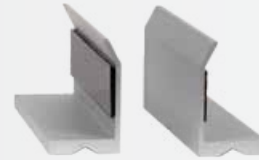

① 1 pair

Description	Width	Height	Part no.
100 mm	100 mm	35 mm	50820L
125 mm	125 mm	35 mm	50830L
150 mm	150 mm	35 mm	50840L



**Hydraulic Press**

**Workshop press**



Suitable for heavy-duty day-to-day work in the workshop

- Makes the replacement of e.g. wheel bearings, gearshaft bearings, rubber bushes etc. much easier
- Large working range thanks to 9-fold adjustment of support surface
- Compression force can be read off on a large dial from 0 to 20 tons
- working range: 0 - 910 mm
- working pressure 20 tons
- 20 tons



Stroke

150 mm

Part no.

20320L

**Air Compressor**

**Piston compressor**



- V-belt powered 2-cylinder serial power unit
- includes a pressure reducer for setting an exact delivery pressure
- start up relief via a Condor MDR 2 pressure switch
- with large profiled, ball bearing hard rubber wheels
- condensate discharge takes place by means of a ball cock



Suction capacity

360 l/min

Pressure vessel capacity

50 l

Part no.

25200L

**Piston compressor**



- V-belt powered 2-cylinder, single step power unit
- start up relief via the pressure switch control
- with large profiled, ball bearing hard rubber wheels and castor wheels for simple handling
- condensate discharge takes place by means of a ball cock
- scope of delivery includes a phase changing plug



Suction capacity

600 l/min

Pressure vessel capacity

90 l

Part no.

25201L

## Piston compressor

- V-belt powered 2-cylinder serial power unit
- start up relief via a Condor MDR 2 pressure switch
- with large profiled, ball bearing hard rubber wheels
- condensate discharge takes place by means of a ball cock
- scope of delivery includes a phase changing plug
- 2 castor wheels on the front for perfect handling



Suction capacity	Pressure vessel capacity	Part no.
780 l/min	90 l	25202L

## Piston compressor

- V-belt powered 2-cylinder, single step power unit
- start up relief via a Condor pressure control switch
- with large profiled, ball bearing hard rubber wheels and castor wheels for simple handling
- condensate discharge takes place by means of a ball cock



Suction capacity	Pressure vessel capacity	Part no.
600 l/min	200 l	25203L

## Piston compressor

- space-saving compressed air tank (standing embodiment)
- slow-running 2 cylinder serial power unit with a high level of effectiveness
- large-size suction air filter
- incl. a damper set for vibration-free operation
- condensate discharge takes place by means of a ball cock



Suction capacity	Pressure vessel capacity	Part no.
690 l/min	270 l	25204L



## Pneumatic Air Maintenance Unit



The pneumatic air maintenance unit consists of pressure regulator, moisture separator and oil-mist lubricator, and thus offers a complete maintenance unit for your pneumatic tools. Two independent extraction points with quick coupling reliably supply filtered and dry pneumatic air, for example for spray guns, or additionally oiled pneumatic air, for example for impact screwdrivers. In this way you achieve optimum conditions for the tools in use and extend their service life.



- maximum air pressure in the intake: 15 bar
- maximum temperature: 60°C (at maximum pressure)
- filter insert: 10 μ
- adjustment range of the regulator : 0.5 to 11 bar
- adjustment range of the oil-mist lubricator: 1 drop every 300 to 600 l/min.
- Max. throughput quantity: 3,100 l/min

Part no.  
**25029L**

## Garage Furniture

### Workbench



with two sheet steel drawers and two lockable doors

- stable wooden work surface
- 1200 x 850 x 600 mm



Description	Length	Width	Height	Part no.
Black / silver	1200 mm	600 mm	850 mm	<b>07500L</b>



# WORKSHOP DEMAND



**SW-Stahl**



# WORKSHOP DEMAND

## 698-729



- ▶ Workshop Clothing 700-701
- ▶ Ear and Eye Protection 702-703
- ▶ Gloves / Hand Cleaning 703-706
- ▶ Cutting Wheels / Roughing Discs 706-708
- ▶ Tow Ropes 708-709
- ▶ Ratchet Straps 709
- ▶ Safety Padlocks 709-710
- ▶ Industrial Plugs and Sockets 710
- ▶ Trailer adapter plug 711
- ▶ Assorted Consumables 711-728





## SW-Stahl softshell jacket



blue

- adjustable sleeve cuffs
- material waterproof up to 10,000 mm column of water - seams not sealed
- breathability 5,000 mm
- 40% polyester, 60% elastane
- with sleeve and inner pocket
- 2 large outer pockets
- embroidered with SW-Stahl logo and lettering / Sauer Logo



Description	Part no.
Size S	5000-S
Size M	5000-M
Size L	5000-L
Size XL	5000-XL
Size XXL	5000-XXL
Size XXXL	5000-XXXL

## SW-Stahl softshell sleeveless jacket



blue

- waterproof up to 8,000 mm column of water
- breathable up to 1000 g/m<sup>2</sup>/24h
- 40% polyester, 60% elastane
- sporty design
- 2 side pockets with zip
- 1 breast pocket with zip
- back cut longer
- elastic at the hem
- embroidered with SW-Stahl logo and lettering / Sauer logo



Description	Part no.
Size S	5001-S
Size M	5001-M
Size L	5001-L
Size XL	5001-XL
Size XXL	5001-XXL
Size XXXL	5001-XXXL

## SW-Stahl t-shirt



blue

- embroidered with SW-Stahl logo and lettering / Sauer logo
- 100% cotton



Description	Part no.
Size S	5002-S
Size M	5002-M
Size L	5002-L
Size XL	5002-XL
Size XXL	5002-XXL

## SW-Stahl poloshirt

blue

- finely woven piqué quality
- made of long-staple, ring-spun and combed cotton
- button facing with 3 buttons
- 100% cotton
- neckband
- side slits with double bars
- pre-shrunk (sanforised)
- embroidered with SW-Stahl logo and lettering / Sauer logo



### Description

### Part no.

Size S	50003-S
Size M	50003-M
Size L	50003-L
Size XL	50003-XL
Size XXL	50003-XXL
Size XXXL	50003-XXXL

## SW-Stahl sweatshirt

blue

- made of easy-care mixed fibres
- with collar
- button facing with 3 buttons
- waistband and sleeve cuffs ribbed for a better fit
- material: 60% cotton, 40% polyester
- embroidered with SW-Stahl logo and lettering / Sauer logo



### Description

### Part no.

Size S	50004-S
Size L	50004-M
Size L	50004-L
Size XL	50004-XL
Size XXL	50004-XXL
Size XXXL	50004-XXXL

## SW-Stahl trousers

blue

- triple fell seams on the legs and in the crotch
- with belt loops and zip
- back pockets with Velcro fastening for safe storage
- thigh pocket for mobile phone with flap and adjustable Velcro fastening
- coin and pen pocket
- material: 65% polyester, 35% cotton
- embroidered with SW-Stahl logo / Sauer logo



### Description

### Part no.

Size S	50005-S
Size M	50005-M
Size L	50005-L
Size XL	50005-XL
Size XXL	50005-XXL
Size XXXL	50005-XXXL



## Ear protection



with adjustable muffs

- frequency: 250 - 800 Hz
- sound weakening: 8,8 - 33,1 dB



Part no.  
**S9731**

## Coarse dust glasses



Full view glasses, non-fogging



Part no.  
**11105SB**

## Protective goggles



with exchangeable lenses, splinterfree according to DIN



Description	Part no.
Sanding goggles complete, transparent	<b>11101L</b>
Replacement glass, transparent	<b>11110L</b>

## Protective goggles



colourless, scratchproof, DIN EN 166

- Sporty design
- Provide protection from general mechanical risks
- Calibrated and perfect adaptation to head shape thanks to two-component side pieces
- Lenses completely made of polycarbonate



Part no.  
**11100L**

## Protective goggles



with clear lenses in the fitting and fold-down ATHERMAL lenses according to DIN GS, also suitable for spectacle wearers



Description	Part no.
Complete with lenses	<b>S3517</b>

## Protective goggles



with exchangeable lenses, splinterfree according to DIN



Description	Part no.
Welding goggles, green ATHERMAL, DIN 5	<b>11102L</b>
Replacement glass, green ATHERMAL, DIN 4	<b>11120L</b>

## Welding helmet



blacks out automatically. Due to integrated solar cell batteries are no longer necessary.

- in carbon-look
- visual range: 98 x 40 mm
- measure of the filter: 110 x 90 mm
- automatical connecting time 1/25,000 sec.
- adapting time: 0.4 sec.
- 4 half-shade levels
- 9 - 13 shade-options
- operating temperature -5°C - +55°C
- automatical control of sensitivity continuously variable



Description	Part no.
Welding helmet	11230L
Replacement glass	11231L
Headband	11230L-1

## Welder's protective visor



made of fibreglass  
Viewing window size: 90 x 110 mm



Description	Part no.
Protective visor fitting without viewing window	11200L

## Protective glass



90 x 110 mm

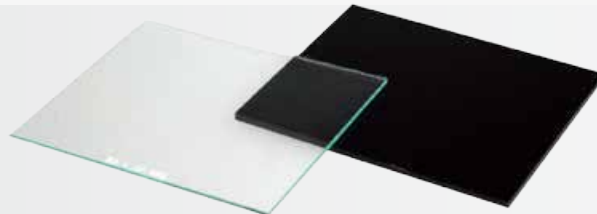

Description	Part no.
Replacement glass, transparent	11210L
Replacement glass, tinted DIN 11	11220L

## Gloves / Hand Cleaning

### Fine-knitted glove



Nylon, with shrink-roughened latex coating, back of hand and upper side of fingers free, acc. to EN 388, cat. II

- Excellent wet and dry grip
- colour black/grey



Description	Part no.
Size 9, black / grey	11521L
Size 10, black / grey	11522L





## Fine-knitted glove

Nylon, with nitrile/PU "foam" coating, back of hand and upper side of fingers free, acc. to EN 388, cat. II



- breathable thanks to new kind of "foam" coating, excellent new ergonomic fit (fits like a second skin), excellent flexibility, making the glove extremely comfortable to wear
- very good wet and dry grip, good resistance to abrasion and cutting
- ideal for all jobs where it's important to feel what you are doing, automotive industry and automotive supplier industry, precision fitting, general fitting work, light general tasks of all kinds, packaging industry, sorting work, transport, general craftsmen

① 10 pair



Description	Part no.
Size 9, grey / black	Z632
Size 10, grey / black	Z633

## Fine-knitted glove

Nylon, with nitrile/PU "foam" coating, back of hand and upper side of fingers free, acc. to EN 388, cat. II



- Breathable thanks to new kind of "foam" coating, excellent new ergonomic fit (fits like a second skin), excellent flexibility, making the glove extremely comfortable to wear
- Very good wet and dry grip, good resistance to abrasion and cutting
- Ideal for all jobs where it's important to feel what you are doing, automotive industry and automotive supplier industry, precision fitting, general fitting work, light general tasks of all kinds, packaging industry, sorting work, transport, general craftsmen



Description	Part no.
Size 9, grey / black	11531L
Size 10, grey / black	11532L
Size 11, grey / black	11533L

## Work glove

Nappa calf leather acc. to EN 388, cat. II



- Selected quality, excellent fit, with very good flexibility, very comfortable to wear
- For general tasks of all kinds, automotive industry and automotive supplier industry, packaging industry, construction work, craftsmen in general, general fitting work, transport and sorting work



Description	Part no.
Size 9, blue / white	11541L
Size 10, blue / white	11542L

## Mechanic's glove

made of washable high-tech material, with padded spandex back, anti-vibration padding made of PVC-rubber



- high-grade materials, complex machining, extremely comfortable to wear, flexible
- good wet and dry grip, fashionable design
- light general work of all kinds, impact screwdriver work, fitting work, exhibition stand building, hobby and leisure



Description	Part no.
Size 9, blue / black	11551L
Size 10, blue / black	11552L



## Fine-knitted glove



with PU coating, back of hand and upper side of fingers free, acc. to EN 388, cat. II

- black colour
- for the fitting, inspection and packing of small components, light fitting work
- good movement for the precise handling of small objects
- very comfortable to wear



① 10 pairs

Description	Part no.
Size 9 (L), black	Z634
Size 10 (L), black	Z635

## Fine-knitted glove



with PU coating, back of hand and upper side of fingers free, acc. to EN 388, cat. II

- black colour
- for the fitting, inspection and packing of small components light fitting work
- good movement for the precise handling of small objects
- very comfortable to wear



Description	Part no.
Size 9 (L), black	11561L
Size 10 (L), black	11562L

## Multi-purpose glove



Nylon, with blue PVC pimples on one side acc. to EN 388, cat. II

- flexible, extremely good fit, very comfortable to wear
- for light general tasks of all kinds, automotive industry and automotive supplier industry, packaging industry, construction work, craftsmen in general, general fitting work, transport and sorting work



Description	Part no.
Size 9 (L), grey	11511L
Size 10 (L), grey	11512L

## Nitrile glove



made of cotton, partly coated, with knitted cuff, acc. to EN 388, cat. II

- good resistance to abrasion and cutting, yet still flexible, new fit, very comfortable to wear.
- for light general tasks of all kinds, automotive industry and automotive supplier industry, packaging industry, construction work, craftsmen in general, general fitting work, transport and sorting work



① 10 pairs

Description	Part no.
Size 9 (L), yellow	Z630
Size 10 (L), yellow	Z631





## Nitrile glove



made of cotton, partly coated, with knitted cuff acc. to EN 388, cat. II

- good resistance to abrasion and cutting, yet still flexible, new fit, very comfortable to wear.
- for light general tasks of all kinds, automotive industry and automotive supplier industry, packaging industry, construction work, craftsmen in general, general fitting work, transport and sorting work



Description	Part no.
Size 9 (L), yellow	11501L
Size 10 (L), yellow	11502L

## Cutting Wheels / Roughing Discs

### Cutting wheel



for metal, cold pressed, DSA approval, max 13,280 rpm., for steel / stainless steel



Description	D	Height	Part no.
ONLY 1mm thick, also for STAINLESS STEEL	115 mm	1 mm	9601-M
ONLY 1mm thick, also for STAINLESS STEEL	125 mm	1 mm	9602-M
	178 mm	3 mm	9604-M
	230 mm	3 mm	9605-M

### Cutting wheel



for metal, cold-pressed.

100 x 1.0 x 16 mm - suitable for pneumatic angle grinder S3268



Description	D	Height	Part no.
max. 15.280 U/min	100 mm	1 mm	9600-M

### Roughing disc



for metal, cold pressed, DSA approval, max 12,200 rpm.



D	Height	Part no.
125 mm	6 mm	9654-M
230 mm	6 mm	9662-M

## Flap Disc



According to EN 12413. The conical shape provides an excellent angle for contour and edge grinding. Designed for machining aluminium, non-ferrous metals, mild steel, wood and plastic.



- max. 13,280 rpm.
- 115 mm diameter
- 22 mm thick

Description	Part no.
Grit 40	81301L
Grit 60	81302L
Grit 80	81303L
Grit 120	81304L

## Flap Disc

According to EN 12413. The conical shape provides an excellent angle for contour and edge grinding. Designed for machining aluminium, non-ferrous metals, mild steel, wood and plastic.



- max. 13,200 rpm.
- 125 mm diameter
- 22 mm thick

Description	Part no.
Grit 40	81310L
Grit 60	81311L
Grit 80	81312L
Grit 120	81313L

## Rubber support disc



for angle grinder



Description	Part no.
115 mm	81305SB

## Metal sawblades



12 units - 150 mm long



Length	Part no.
150 mm	71800L

## Saw blade for bodywork



for use with the pneumatic bodywork saw 40008L as well as models from Pneutec, Ober, CP etc.

- bi-metal



Description	Part no.
18 Teeth, 1.4 Pitch - plastics / aluminium	70618L
24 Teeth, 1.0 Pitch - plastics / aluminium	70624L
32 Teeth, 0.7 Pitch - plastics / aluminium	70632L





## Chassis saw blade



for use with compressed air chassis jigsaws, e.g. SIG, Flex,

- Bimetal



Description	Part no.
18 Teeth, 1.4 Pitch - plastics / aluminium	70718L
24 Teeth, 1.0 Pitch - steel / iron sheets	70724L
32 Teeth, 0.7 Pitch - steel / iron sheets	70732L

## Metal sawblade



HSS Biflex high-performance blade, 24 teeth/inch

- Made in Germany



Description	Length	Part no.
HSS Biflex high-performance blade	300 mm	71600L
10-piece	300 mm	71650L

## Reciprocating saw blade



HSS, tooth pitch 1.4, for steel and stainless steel measuring 1.5 to 2.5 mm, milled and corrugated teeth, long-life design, pack of 5

- Made in Germany



Description	Part no.
150 x 19 x 0,9 mm	71615L
200 x 19 x 0,9 mm	71616L

## Replacement break-off blades



in plastic case



Description	Part no.
10-piece, 18 mm wide	90620L
10-piece, 9 mm wide	90630L

## Trapezoidal blades



5 top-quality replacement blades



Description	Part no.
5 top-quality replacement blades	90666L

# Tow Ropes

## Passenger car tow rope



flexible, jolt-free, up to 2000 kg permissible overall weight



Part no.  
S9660

## Passenger car tow bar

Jolt-free, goes easy on the vehicle  
for passenger cars up to 2000 kg permissible overall weight



Length  
1,80 m

Part no.  
22400L

## Spanngurte

### Universal lashing box

in practical case

- 2 ratchet straps L = 3.5 m W = 25 mm
- 1 quick-release ratchet strap with metal hook L = 3.5 m W = 25 mm
- 2 tension ropes, elastic with plastic hook and secure clip at both ends L = 550 mm  $\varnothing$  = 9 mm tensile force 70 Nm
- 4 tension ropes, elastic with metal hook, L = 600 mm W = 9 mm tensile force 70 Nm
- 4 suction cup  $\varnothing$  = 120 mm with quick release fastener



Description  
15-piece

Part no.  
S3591

### Lashing strap

self-clamping, also ideal for lashing luggage to motorbikes



Description  
2,5 m x 25 mm

Part no.  
S3598

### Ratchet clamping strap

one-piece

- Lashing capacity (LC) up to 120 daN (kg)
- 5 m long



ⓘ **Not suitable for lifting!**

Description  
Ratchet clamping strap 5 m  
2 double suction cups + ratchet clamping strap

Part no.  
30005L  
40000L

## Safety Padlocks

### Brass padlock

with 3 keys



Description  
Width of hoop 30 mm  
Width of hoop 40 mm  
Width of hoop 50 mm

Part no.  
60702SB  
60704SB  
60705SB



## Safety padlock



Solid-steel version, hardened hoop with 13 mm diameter, 5 keys

- clear hoop height 15 mm
- clear hoop width 34 mm



Part no.  
**60708L**

## Safety padlock



solid-steel version, hardened hoop with 10 mm diameter, 3 keys

- clear hoop height 50 mm
- clear hoop width 20 mm

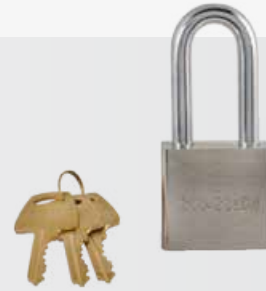

Part no.  
**60706L**

## Safety padlock



Solid-steel version, hardened hoop with 13 mm diameter, 5 keys

- clear hoop height 40 mm
- clear hoop width 32 mm



Part no.  
**60710L**

# Industrial Plugs and Sockets

## Industrial plug



250V / 16A, 2-pole plus ground

- made of plastic
- with rubber grommet on cable side



Part no.  
**32410L**

## Industrial socket



250V / 16A, 2-pole plus ground  
made of plastic with spring-loaded cover for protection  
against soiling and wetness.

- with rubber grommet on cable side
- enclosure rating IP 54 (dust and splashwater protection)



Part no.  
**32411L**

## Adapter for trailer connector

for 12-volt power supply with copper pins in a plastic housing.



## Assorted Consumables

### SW-Stahl Multi-Tape



For fast emergency repairs on vehicles, machinery and boats. Can be used both for sealing hoses, tubes or lines as well as for insulating cables and plug connectors.

The silicone tape adheres only to itself so it is not dependent on the condition of the substrate, which can be a problem with conventional tapes. The upshot is it can also be processed on oily, wet and dirty substrates.

Ideal for instance for damage caused by martens on the radiator hose and repairs when the spare part is not in stock or the time schedule is full. That way, the customer can still use the vehicle until the next appointment.

- resistant to fuel, oils, acids, solvents and salt
- waterproof and airtight in seconds
- immediately self-sealing
- durably resilient
- UV resistant
- flexible up to 400%
- long-term seal
- even works under water
- insulates up to 12,000 volts (per layer)
- temperature-resistant from -65°C to 260°C
- can be removed residue-free
- compression-proof up to 12 bar (on a hose diameter of 25 mm)
- packed in a practical, reclosable plastic box

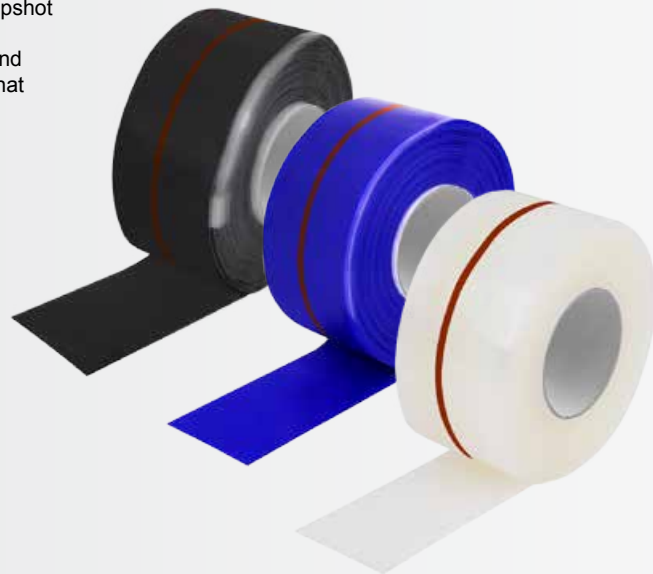

Description	Length	Width	Part no.
black	3,60 m	25,40 mm	62016L
blue	3,60 m	25,40 mm	62017L
transparent	3,60 m	25,40 mm	62018L

### Volvo trim clip assortment



the box contains the following clips:

- 30 x Nissan push-type retainer (OE: 8099905N07 / 9046707043)
- 25 x Volvo bumper cover retainer (OE: 1268176)
- 50 x BMW moulding clip (OE: 51131804205)
- 50 x Volvo body side moulding clip (OE: 171583585 / 591740)
- 30 x Nissan push-type retainer (OE: 6384801G00)
- 25 x Volvo rocker panel retainer (OE: 9133417)
- 50 x Volvo bonnet insulation & radiator retainer (OE: 9133073)
- 30 x Volvo black fir tree retainer (OE: 3272075327462B)
- 25 x Volvo grey fir tree retainer (OE: 327462A)
- 24 x Volvo bonnet prop rod clip (OE: 3923712)
- Peugeot/Citroën push-type retainer (OE: 790307216 / 947098 / A0009903492)
- Fiat interior trim retainer (OE: 4292906)



Volvo

Description	Part no.
350-piece	S8015



## Plastic rivets assortment



the box contains the following clips:

- 15 x Ford plastic rivet for cowl grill (OE: N804583S)
- 30 x VW plastic rivet (OE: 1758535570C / 6503800)
- 15 x Ford plastic rivet (OE: 14063981 / 6500911 / N8030433)
- 25 x Chrysler connect blind rivet retainer (OE: 6500898)
- 15 x BMW connect blind rivet retainer (OE: 51717002953)
- 15 x GM plastic rivet (OE: 15506827)
- 15 x GM plastic rivet (OE: 14070914)
- 20 x Chrysler connect blind rivet retainer (OE: 25524005)
- 35 x GM Connect blind rivet retainer (OE: 204655395 / 6004212)
- 15 x GM connect blind rivet retainer (OE: 10036503)
- 15 x GM connect blind rivet retainer (OE: 10109689)
- 15 x Ford plastic rivet (OE: 6503860 / N804675S)



**Description**

235-piece

**Part no.**

**S8016**

## Fir tree fixings assortment



the box contains the following clips:

- 30 x Ford fir tree fixing (OE: 388577S)
- 30 x Ford fir tree fixing (OE: 6998849)
- 15 x universal fir tree fixing, white (OE: 6003423)
- 15 x VW fir tree fixing (OE: 385661 / 6003349 / N989022)
- 50 x Chrysler connect weatherstrip retainer (OE: 20699808 / 6502328)
- 10 x Ford connect bumper fascia (OE: N804379S)
- 35 x Mazda connect hood insulation retainer (OE: F22Z16774A / 6508197AA)
- 30 x GM connect bumper cover retainer (OE: 16674629 / N806113S)
- 50 x Nissan cowl grill fir tree (OE: 0153301781)
- 20 x VW fir tree fixing (OE: 2207713 / 514719044317 / N9020160H)
- 25 x fir tree fixing
- 30 x Toyota fir tree fixing



**Description**

340-piece

**Part no.**

**S8017**

## Renault trim clip assortment



the box contains the following clips:

- 60 x Mercedes-Benz connect plastic barrel nut (OE: 7703074022 / A108980027)
- 65 x Renault connect push-in retainer (OE: 7703077059/14188380)
- 50 x Renault door trim retainer (OE: 7703077421)
- 60 x Renault push-type-retainer (OE: 7703081184)
- 50 x universal connect push fit retainer
- 15 x Renault plate buckle, grey



**Description**

300-piece

**Part no.**

**S8018**

**Renault**



## Vauxhall/Opel trim clip assortment

the box contains the following clips:

- 40 x Opel trim panel retainer (OE: 1591426 / 174864)
- 20 x Opel retaining clips (OE: 90218614)
- 100 x VW connect hammer-in retainer (OE: 7814.24 / N0385501)
- 50 x Opel retaining clip, blue (OE: 2345959 / 7701053516 / 7L5853994)
- 50 x Opel retaining clip, black (OE: 2240582)
- 40 x Opel plastic screw nut (OE: 180942)



Opel  
Vauxhall



Description

300-piece

Part no.

S8019

## Peugeot/ Citroën trim clip assortment

the box contains the following clips:

- 50 x Peugeot/Citroën push-type-retainer (OE: 790307216 / 947098 / A0009903492)
- 20 x Peugeot/Citroën trim panel retainer (OE: 856535)
- 20 x Peugeot/Citroën connect side moulding grommet (OE: 357853575 / 6991W4)
- 20 x Peugeot/Citroën universal retainer
- 25 x Peugeot/Citroën retainer (OE: 694143)
- 35 x Peugeot/Citroën retainer (OE: 743707)
- 15 x Peugeot/Citroën connect buckle fixing (OE: 698317)
- 25 x Peugeot/Citroën trim retainer (OE: 699502)
- 30 x Peugeot/Citroën trim retainer (OE: 6995X3)
- 40 x Peugeot/Citroën trim retainer (OE: 69945)
- 35 x Renault connect push-in retainer (OE: 14188380 / 7703077059)
- 30 x Mercedes-Benz connect plastic barrel nut (OE: 7703074022 / A108980027)



Peugeot  
Citroën



Description

345-piece

Part no.

S8020

## Fiat trim clip assortment

the box contains the following clips:

- 30 x Fiat interior trim retainer (OE: 4292906)
- 20 x Fiat push-type retainer (OE: 1459487)
- 25 x Fiat push-type retainer (OE: 1300433650)
- 8 x Fiat/BMW push-type retainer (OE: 71717421)
- 25 x Fiat/VW trim retainer (OE: 82456515)
- 25 x Fiat trim retainer (OE: 5757139)
- 20 x Fiat interior trim retainer (OE: 1459387)
- 25 x Fiat trim retainer (OE: 14188282 / 46306526 / 60507749)
- 25 x Fiat trim retainer (OE: 14591687)
- 25 x Fiat/Iveco trim retainer (OE: 1452387)
- 30 x Fiat/Toyota/Nissan screw grommet (OE: 83468473)
- 50 x Fiat retainer (OE: 7677865)



Fiat



Description

308-piece

Part no.

S8021



## Honda trim clip assortment



the box contains the following clips:

Honda

- 15 x Honda push-type-retainer (OE: 75521611000 / 90675SB003)
- 8 x Honda push-type-retainer (OE: 91502SP0003)
- 20 x Honda trim panel retainer (OE: 91566SP0003)
- 50 x Honda hood seal retainer (OE: 91513SE003)
- 40 x Honda weatherstrip retainer (OE: 91530ST5003)
- 20 x Honda side & trunk lining retainer (OE: 91550SH3003)
- 25 x Honda screw grommet (OE: 91620SR2003)
- 5 x Honda radiator grill retainer (OE: 91578SV4003)
- 30 x Honda retainer (OE: 38529689A6300)
- 15 x Honda push-type-retainer (OE: 91512SX0003)
- 15 x Honda retainer (OE: 906876710030)
- 30 x Honda push-type-retainer (OE: 90683SA5003)
- 30 x Honda retainer (OE: 01553 / 90687SA50030)
- 15 x Honda push-type retainer (OE: 91808SM4000)
- 30 x Honda moulding retainer (OE: 91534SE0000)
- 20 x Honda side marker clip (OE: 34355SD2003)
- 30 x Toyota front grill clip (OE: 8942180270 / 9046712020)
- 20 x Toyota retainer (OE: 9046709065 / 90672671003)



Description

Part no.

418-piece

S8022

## Nissan trim clip assortment



the box contains the following clips:

Nissan

- 30 x Chrysler/Mazda retainer (OE: 76906T300 / 813350022)
- 15 x Honda push-type-retainer (OE: 75521611000 / 90675SB003)
- 25 x Honda trim panel retainer (OE: 8942798070 / 90667SA70030)
- 25 x Honda connect screw grommet (OE: 78856R4301 / 906836930000)
- 10 x Nissan nylon U-nut (OE: 5378914010 / 63848D400)
- 25 x Nissan square nut retainer (OE: 68425H5000)
- 15 x Nissan push-type-retainer (OE: 1007932 / 6384401A00)
- 30 x Nissan push-type-retainer (OE: 1099830880 / 8942981190 / KK37668868)
- 8 x Nissan bumper cover connecting retainer (OE: 0155301393 / BF8250233)
- 20 x Nissan push-type-retainer (OE: 6384801G00)
- 50 x Nissan retainer (OE: 62869N4700)
- 15 x Nissan grill grommet (OE: 62380U7400)
- 20 x Nissan push-type-retainer (OE: 7688257A00)
- 40 x Nissan radiator grill retainer (OE: 6684101G00)
- 10 x Nissan push-type-retainer (OE: 6387801E10)
- 15 x Nissan flush sheet plug (Nissan universal)
- 15 x Nissan push-type-rivet (OE: 6385401A00)
- 40 x Toyota retainer (OE: 015530172 / 9046707050)



Description

Part no.

408-piece

S8023

## Mazda trim clip assortment



the box contains the following clips:

- 50 x Mazda retaining clip (OE: B45556741 / F1CZ16674A)
- 20 x push-type retainer (OE: 2042301 / MB345544)
- 25 x connect square nut retainer (OE: 0128100501 / 999100402)
- 20 x retaining clip (OE: 9095001248 / B0016830200)
- 25 x push-type-retainer (OE: 90657SA60030 / 9418687 / N30413356A)
- 40 x connect retaining clip (OE: 0155300291 / 992640543A)
- 30 x connect hood insulation retainer (OE: 6508197AA / F22Z16774A)
- 5 x connect bumper cover retainer (OE: BF8250233)
- 20 x connect interior trim retainer (OE: B1016825200)
- 15 x push-type-retainer (OE: B09251833)
- 50 x connect weatherstrip retainer (OE: 6786889101 / G03158762)
- 5 x Mazda bumper retainer (OE: BF6750033)
- 20 x rod end clip (left side) (OE: 992780405)
- 20 x rod end clip (right side) (OE: 992780404)
- 50 x Mazda fir tree retainer (also for general use) (OE: 99249051B)
- 15 x Mazda push-type-retainer (OE: BC1DSA145)
- 50 x Mazda trim retainer (OE: 992640543A)
- 15 x connect wheel housing retainer (OE: 9046709139)



Description

Part no.

475-piece

S8024

## Mitsubishi trim clip assortment



Mitsubishi

the box contains the following clips:

- 50 x Mitsubishi square nut retainer (OE: 9018905013)
- 30 x Mitsubishi screw grommet (OE: 9018906001 / MU480033)
- 15 x Mitsubishi push-type-retainer (OE: MB253964)
- 15 x Mitsubishi bumper cover grommet (OE: MB271999)
- 10 x Mitsubishi push-type-retainer (OE: MR200300)
- 30 x Mitsubishi screw grommet (OE: MU480034)
- 10 x Mitsubishi push-type-retainer (OE: MR138807)
- 10 x Mitsubishi retainer (OE: HB121467)
- 40 x Mitsubishi push-type-retainer (OE: MB696120)
- 40 x Nissan rock panel retainer (OE: MB846992)
- 50 x Toyota grill clip (OE: 8942180270 / 9046712020)
- 30 x Toyota grommet round nut retainer (OE: 0128100231 / 9018906001)



Description

Part no.

370-piece

S8025



## BMW mounting clip assortment



BMW

The box contains the following clips:

- 80 x Barrel Nut (OE: 51311802258)
- 35 x Bumper-Trim-Retainer (OE: 51118174185)
- 35 x Push-Type-Retainer (OE: 51481938725)
- 40 x Retainer (OE: 703867299 / 823867299)
- 20 x Push-Type-Retainer (OE: 51131960054)
- 80 x Retainer (OE: 51131804205)



Description

Part no.

290-piece

S8026

## Ford trim clip assortment



Ford

the box contains the following clips:

- 25 x Ford fir tree shield retainer (OE: 388577S)
- 20 x Ford push-type-retainer (OE: 10139622 7 1673046 / 6508197AA)
- 30 x Mazda retainer (OE: B45556741 / F1CZ16674A)
- 15 x Ford inner fender push-type-retainer (OE: N8011925S)
- 40 x Ford weatherstrip retainer (OE: N806289S)
- 30 x Ford square screw nut (OE: N379830S)
- 10 x Ford retainer (OE: N387496S)
- 35 x Ford fir tree shield retainer (OE: N803170S)
- 10 x Ford push-type-retainer (OE: W704958S300)
- 20 x Ford push-type-retainer (OE: NAU156145 / W706713S300)
- 35 x Ford fir tree shield retainer (OE: N388246S)
- 15 x Ford retainer (OE: N387944S)
- 20 x Ford push-type-retainer (OE: N805231S)
- 15 x Ford retainer (OE: W705532S300)
- 15 x Ford push-type-retainer (OE: W710250S300)
- 35 x GM tail light retainer (OE: 16500308 / 6500787)
- 30 x Mazda hood insulation retainer (OE: 6508197AA / F22Z16774A)
- 15 x Nissan push-type-retainer (OE: 1007932 / 6384401A00)



Description

Part no.

415-piece

S8027

## Mercedes-Benz mounting clip assortment



Mercedes-Benz

The following clips are included in the cassette:

- 30 x Mercedes Connect Plastic Barrel Nut Pack (OE: 7703074022 / A108980027)
- 15 x Mercedes Push Type Retainer (OE: A1269900392)
- 30 x Mercedes Retaining Clip (OE: A0019882981)
- 25 x Mercedes Push Type Retainer (OE: A1249900492)
- 5 x Mercedes Retaining Clip (OE: A0019888081)
- 10 x Mercedes Retaining Clip (OE: A1249880492)
- 15 x Mercedes Push Type Retainer (OE: A9904692)
- 40 x Mercedes Push Type Retainer (OE: A0009908492)
- 30 x Mercedes Retaining Clip (OE: A0019880325)
- 15 x Mercedes Fir Tree Fixing (OE: A1406980260)
- 20 x Mercedes Retaining Clip (OE: A0019885081)
- 35 x Mercedes Retaining Clip (OE: A0019884481)



Description

Part no.

270-piece

S8028

## VW mounting clip assortment



The following clips are included in the cassette:

- 20 x AUDI / VW Retaining Clip (OE: 3A0853575 / 3A0853575A)
- 30 x AUDI Connect Door Moulding Clip (OE: 6U085733)
- 20 x VW Fir Tree Fixing (OE: 2207713 / 514719044317 / N9020160H)
- 30 x VW Connect Hammer-In Retainer (OE: 7814.24 / N0385501)
- 5 x VW Retaining Clip (OE: 1H0868243B)
- 30 x VW Screw Grommet (OE: N90833801)
- 15 x VW Plastic Clip (OE: 4A0853825 / 4A0853825A)
- 10 x VW Retaining Clip (OE: 3B0853576)
- 25 x VW Retaining Clip (OE: 1H0819055B01C)
- 15 x VW Green Plastic Retainer (OE: 443853909A)
- 30 x VW Grey Push Type Retainer (OE: 171885767)
- 25 x VW Plastic Screw Nut (OE: 191941142)



**Description**

255-piece

**Part no.**

**S8029**

## AUDI mounting clip assortment



Audi

The following clips are included in the cassette:

- 10 x Push-Type Retainer (OE: 1H0867199A / 51481915964)
- 10 x Connect Trim Retainer (OE: 1H086243 / 1H0868243B)
- 10 x Connect Retaining Grommet (OE: 1H0853585A)
- 5 x Connect Retaining Grommet (OE: 3A0853575)
- 20 x Connect Retaining Grommet (OE: 3B0853575)
- 20 x VW Retainer Clip (OE: 3A0853575 / 3A0853575A)
- 10 x AUDI Plastic Clip (Also suits VW) (OE: 4A0853825C)
- 15 x AUDI Hood Strut Socket (OE: 1H0823397)
- 15 x AUDI Push Type Retainer (OE: 1H0819055C01C)
- 10 x Connect Door Trim Retainer (OE: 3B0838243 / 3B0868243)
- 20 x Connect Side Moulding Grommet (OE: 357853575 / 6991W4)
- 15 x VW Plastic Clip (Also suits Audi) (OE: 4A0853825 / 4A0853825A)



**Description**

160-piece

**Part no.**

**S8030**

## Plastic locking nut assortment



the box contains the following clips:

- 25 x Fiat/Toyota/Nissan screw grommet (OE: 83468473)
- 40 x Ford screw nut (OE: N379830S)
- 40 x Mazda connect square nut retainer (OE: 0128100501 / 999100402)
- 25 x Mercedes-Benz retaining clip (OE: A0019882981)
- 30 x Mitsubishi square nut retainer (OE: 9018905013)
- 25 x Mitsubishi screw grommet (OE: MU480034)
- 25 x Renault push-type-retainer (OE: 7703081184)
- 20 x Toyota round nut retainer (OE: 9018906013)
- 30 x Toyota round nut retainer (OE: 128100231 / 9018906001)
- 30 x Toyota connect square nut retainer (OE: 7552161100 / 96706P0105)
- 40 x VW connect headlight bezel nut (OE:1370853 / 441035555)



**Description**

350-piece

**Part no.**

**S8031**



## Screw rivet trim fixing assortment



the box contains the following clips:

- 10 x Audi push-type-retainer (OE: 1H0867199A / 51481915964)
- 10 x Audi push-type-retainer (OE: 1H0819055C01C)
- 20 x Ford push-type-retainer (OE: 10139822 / 1673046 / 6508197AA)
- 25 x Ford push-type-retainer (OE: 1007932 / 6502871)
- 20 x Ford push-type-retainer (OE: NAU156145 / W706713S300)
- 20 x Honda push-type-retainer (OE: 75521611000 / 90675SB003)
- 30 x Mazda push-type-retainer (OE: 2042301 / MB345544)
- 15 x Mercedes-Benz push-type-retainer (OE: A1269900392)
- 15 x Mercedes-Benz push-type-retainer (OE: A9904692)
- 20 x Nissan push-type-retainer (OE: 1007932 / 6384401A00)
- 40 x Nissan bumper cover push-type-retainer (OE: 6686001W01 / 94051933)
- 15 x Nissan push-type-retainer (OE: 6387801E10)



Description

Part no.

240-piece

S8032

## Universal mounting clip assortment



the box contains the following clips:

- 30 x Shield Retainer Ø 6,4 mm
- 15 x Shield Retainer Ø 7,1 mm
- 20 x Shield Retainer Ø 7,8 mm
- 20 x Shield Retainer Ø 9,0 mm
- 10 x Shield Retainer Ø 9,5 mm
- 10 x Shield Retainer Ø 10,0 mm
- 20 x Push-Type-Retainer Ø 6,3 mm
- Push-Type-Retainer Ø 8 mm
- Front fender Push-Type-Retainer Ø 8 mm
- 10 x Push-Type-Retainer Ø 9 mm
- Push-Type-Retainer Ø 10 mm (long)
- Push-Type-Retainer Ø 10 mm (short)



Description

Part no.

192-piece

S8033

## Bodyshop metal fasteners assortment



the box contains the following parts:

- 25 x Audi / VW metal speed fastener star centre (OE: N90335004 / N90335006)
- 20 x sheet metal screw c/w captive washer (OE: 07119916946 / N914031006203)
- 25 x Audi / VW (OE: N90796501)
- 30 x sealing rivet with 12.8 mm flange for general use (OE: 9026905065)
- 50 x Toyota sealing rivet with 6.2mm flange (OE: 9026904051)
- 50 x Toyota sealing rivet with 8.7mm flange (OE: 9026904053)
- 25 x Toyota sealing rivet with 12.1 mm flange (OE: 9026905054)
- 50 x metal U-nut No. 8 x 21.0 mm
- 30 x black sheet metal screw c/w captive washer
- 30 x black sheet metal screw c/w captive washer
- 35 x black rivet with 12.0 mm flange for general use
- 30 x black stem rivet 5/32 in. standard flange for general use



Description

Part no.

400-piece

S8034

## Toyota/Lexus trim clip assortment



Lexus  
Toyota

the box contains the following clips:

- 10 x Toyota hood insulation fixing (OE: 9046709006)
- 25 x Toyota round nut retainer (OE: 128100231 / 9018906001)
- 40 x Toyota connect square nut retainer (OE: 75521611000 / 96706P0105)
- 10 x Toyota connect nylon U-nut (OE: 9017905060)
- 25 x Toyota connect rocker panel clip (OE: 9046711063)
- 25 x Toyota connect moulding clip (OE: 7539533030)
- 20 x Toyota/Lexus push-type-retainer (OE: 9046707138)
- 35 x Toyota/Lexus push-type-retainer (OE: 9046707117)
- 30 x Toyota/Lexus retaining clip (OE: 9046709138)
- 15 x Toyota/Lexus bumper cover retainer (OE: 9046709101)
- 15 x Toyota/Lexus bumper cover retainer (OE: 9046709093)
- 10 x Toyota/Lexus side panel retainer (OE: 7504933010)
- 20 x Toyota/Lexus door moulding clip (OE: 7503933060)
- 20 x Toyota/Lexus trim panel retainer (OE: 677711250)
- 15 x Toyota/Lexus push-type-retainer (OE: 9046709143)
- 20 x Toyota/Lexus hood insulation retainer (OE: 9046708124)
- 10 x Toyota/Lexus bumper push-type-retainer (OE: 9046709096)
- 15 x Toyota/Lexus hood insulation fixing (OE: 9046709050)



**Description**  
360-piece

**Part no.**  
S8035

## Cable tie set



the assortment contains the following cable tie types:

- 100 x red 2.5 x 100 mm
- 100 x yellow 2.5 x 100 mm
- 100 x blue 2.5 x 100 mm
- 100 x green 2.5 x 100 mm
- 100 x white 2.5 x 100 mm
- 100 x black 3.6 x 150 mm
- 100 x white 3.6 x 100 mm
- 100 x red 4.8 x 200 mm
- 100 x yellow 4.8 x 200 mm
- 100 x blue 4.8 x 200 mm
- 100 x green 4.8 x 200 mm
- 100 x white 4.8 x 300 mm



**Description**  
1.200-piece

**Part no.**  
S8036





## Copper O-ring assortment



for sealing of e.g. injectors on Common Rail Diesel injection systems (CDI).

includes 10 pcs. per following sizes:

- 13.8 x 7.3 x 1.4 mm
- 14.6 x 7.5 x 1.3 mm
- 14.6 x 7.5 x 3.0 mm
- 15.0 x 7.0 x 2.0 mm
- 15.0 x 7.5 x 1.0 mm
- 15.0 x 7.5 x 1.5 mm
- 15.0 x 7.5 x 2.0 mm
- 15.0 x 7.5 x 2.5 mm
- 15.0 x 7.5 x 3.0 mm
- 15.5 x 7.5 x 2.0 mm
- 16.0 x 7.5 x 1.5 mm
- 16.0 x 7.5 x 1.7 mm
- 16.0 x 7.5 x 2.0 mm
- 16.4 x 7.5 x 2.0 mm
- 20.0 x 9.4 x 0.9 mm



Description	Part no.
150-piece	<b>S8037</b>

## Ear hose clamp assortment



the assortment contains the following hose clamp types:

- 20 x 5.8 - 7.0mm
- 20 x 7.3 - 9.0 mm
- 20 x 8.8 - 10.5 mm
- 20 x 10.8 - 13.3 mm
- 20 x 12.0 - 14.5 mm
- 20 x 12.3 - 14.8 mm
- 20 x 14.5 - 17.0mm
- 15 x 16.0 - 19.2 mm
- 15 x 17.8 - 21.0 mm



Description	Part no.
170-piece	<b>S8038</b>

## Popular drive (push-pin) rivet assortment



the box contains the following clips:

- 40 x Peugeot/Citroën black drive rivet (OE: 790307216 / 947098 / A0009903492)
- 20 x Volvo black drive rivet (OE: 9133417)
- 20 x VW grey drive rivet (OE: 171885767)
- 20 x VW black drive rivet (OE: N16186729901C)
- 40 x VW black drive rivet (OE: 8N0863788)
- 35 x universal black drive rivet
- 40 x VW grey drive rivet (OE: 7814.24 / N0385501)
- 20 x Volvo black drive rivet (OE: 1268176)
- 30 x Mercedes-Benz black drive rivet (OE: A0009903792)
- 30 x Mercedes-Benz black drive rivet (OE: A0009903792)
- 30 x GM white drive rivet (OE: 14005089)
- 25 x Ford black drive rivet (OE: 383142S)



Description	Part no.
350-piece	<b>S8040</b>



## Shrinking hose assortment



in box, assorted sizes, usable up to 125° C, with UL and CSA approval

- 2.0 x 40 mm
- 2.5 x 40 mm
- 3.5 x 40 mm
- 5.0 x 40 mm
- 7.0 x 80 mm
- 10.0 x 80 mm
- 13.0 x 85 mm



**Description**  
127-piece

**Part no.**  
**S8042**

## Seal ring assortment



copper, sizes contained

- in the case (10 pieces each):
- 0.8 mm thick: 20x24.5
- 1.0 mm thick: 5x9, 6x10, 6x12, 8x12, 8x14, 9x14, 10x14, 10x16, 12x16, 13x18, 22x27
- 1.5 mm thick: 8x14, 10x14, 12x16, 12x18, 14x18, 14x20, 16x20, 16x22,
- 18x22, 18x24, 20x24.5, 22x29, 24x29
- 2.0 mm thick: 14x20, 19x26, 24x32, 26x34, 28x36



**Description**  
300-piece

**Part no.**  
**S8142**

## Assortment of sealing rings



copper, in box

Sizes contained (10 pieces each):

- 1 mm thick:
- 5 x 10, 6 x 10, 7 x 10, 8 x 12, 10 x 16
- 1.5 mm thick:
- 10.5 x 17, 11 x 17, 12 x 10, 12.5 x 20, 14 x 18, 14 x 20
- 2 mm thick:
- 15 x 20, 16 x 22, 16.5 x 24, 17.5 x 24



**Description**  
150-piece

**Part no.**  
**S8052**

## Assortment of seal rings



aluminium, for oil drain plugs, suitable for all popular vehicle types (10 pieces each):

- 5 x 9 x 1,0 - 8 x 14 x 1,5 - 12 x 16 x 1,0 - 14 x 20 x 1,5 - 18 x 24 x 1,5 - 22 x 29 x 1,5
- 6 x 10 x 1,0 - 9 x 14 x 1,0 - 12 x 16 x 1,5 - 14 x 20 x 2,0 - 20 x 24,5 x 1,5 - 24 x 29 x 1,5
- 6 x 12 x 1,0 - 10 x 14 x 1,0 - 12 x 18 x 1,5 - 16 x 20 x 1,5 - 20 x 24,5 x 0,8 - 24 x 32 x 2,0
- 8 x 12 x 1,0 - 10 x 14 x 1,5 - 13 x 18 x 1,0 - 16 x 22 x 1,5 - 19 x 26 x 2,0 - 26 x 34 x 2,0
- 8 x 14 x 1,0 - 10 x 16 x 1,0 - 14 x 18 x 1,5 - 18 x 22 x 1,5 - 22 x 27 x 1,0 - 28 x 36 x 2,0

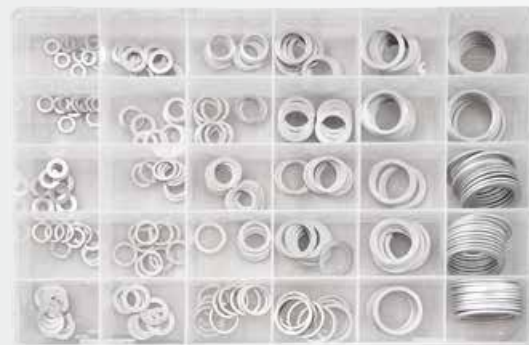

**Description**  
300-piece

**Part no.**  
**S8143**





## O-ring assortment



in box, resistant to acid, petrol and oil. 18 different sizes

- 3x1, 4x1, 4.5x2, 5x2, 6x2, 6x2.5, 6x3, 7x2, 8x2, 9x2, 10x2, 12x3, 13x3, 14x2.5, 17x2.5, 18x4, 20x2, 22x2 mm



Description

225-piece

Part no.

S8044

## O-ring assortment



in box, resistant to acid, break fluid, petrol and oil. Also suitable for air-conditioning systems, 32 different sizes, heat resistant up to 160°

- 3x1,5 - 4,4x2 - 5x2 - 7x1,5 - 10x1,5 - 11x2,5 - 13x2,5 - 14x2,5 - 16x2,5 - 18x2,5 - 19x2,5 - 20x3,5 - 21x2,5 - 22x2,5 - 23,5x3,5 - 25x3,5 - 26,5x3,5 - 28x3,5 - 30x3,5 - 31x3,5 - 33x3,5 - 34,5x3,5 - 36x3,5 - 38x3,5 - 41x3,5 - 44x3,5 - 47x3,5 - 50x3,5 mm



① Suitable for air-conditioning systems

Description

419-piece

Part no.

S8045

## Seal assortment



rubber, fibre, in box, ideal for all applications in the plumbing field



Description

141-piece

Part no.

S8059

## O-ring assortment



- made of HNBR rubber
- for high thermal and chemical load
- ideal for passenger car air-conditioning systems

Different assorted sizes with following inner diameter:

- 3 - 4 - 4,5 - 5 - 6 - 7 - 8 - 9 - 10 - 12 - 13 - 14 - 17 - 18 - 20 - 22 mm



Description

225-piece

Part no.

S8041

## Snap ring assortment



with outer snap rings, assorted

- 3x20 - 4x10 - 5x15 - 6x25 - 8x15 - 9x20 - 11x15 - 12x15 - 13x25 - 14x15 - 15x20 - 19x25 - 20x15 - 22x20 - 25x15 - 26x15 - 28x10 - 32x5 mm



Description  
300-piece

Part no.  
S8046

## Circlip assortment



with inner circlips (snap ring), assorted

- inner diameter  
3 - 4 - 5 - 6 - 8 - 9 - 11 - 12 - 13 - 14 - 15 - 19 - 20 - 22 - 25 - 26 - 28 - 32 mm

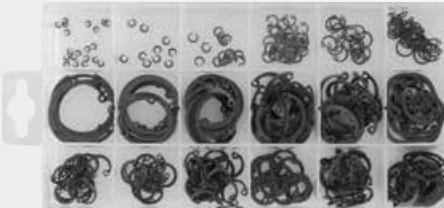

Description  
300-piece

Part no.  
S8049

## Assortment of tensile and compression springs



in box with the following division:

- compression springs:  
5.5x17.5 - 5.5x38.0 - 6.5x10.0 - 7.0x12.5 - 7.0x19.0 - 9.0x35 - 9.5x16 - 9.5x19 mm
- Tensile springs:  
4.0x79.5 - 4.5x44.5 - 5.0x20.5 - 5.5x25.5 - 6.5x22.0 - 7.0x38.0 - 7.0x51.0 - 8.0x28.5 - 8.0x31.5 - 8.0x44.5 - 8.5x36.5 - 8.5x47 mm



Description  
200-piece

Part no.  
S8047

## Hollow pin/assortment of synchroniser rings



in box, with following sizes:

- 2 mm x 20 mm
- 3 + 4 mm x 30 mm
- 3 + 4 + 5 + 5 + 8 + 10 mm x 40 mm
- 4 + 5 + 6 + 8 mm x 50 mm
- 5 + 6 + 8 mm x 60 mm
- 7 mm x 70 mm
- 8 + 10 mm x 80 mm



Description  
450-piece

Part no.  
S8054

## W-clip assortment



in box, chrome-plated, with following sizes:

- 2.4 x 31 mm
- 2.0 x 3 mm
- 2.0 x 40 mm
- 2.8 x 42 mm
- 3.5 x 45 mm
- 4.0 x 75 mm



Description  
150-piece

Part no.  
S8043



## Assortment of pins



in box, assorted

- 1.6x25 - 2.5x25 - 2.4x38 - 3.2x32 - 3.2x50 - 4.0x64 mm



Description

555-piece

Part no.

S8048

## Hose clamp set



sizes contained:

- 4 x 40 mm, 2 x 35 mm, 2 x 28 mm, 4 x 25 mm, 6 x 22 mm, 8 x 16 mm



Description

26-piece

Part no.

S8055

## Assortment of feather keys



in a box, 10 of each with the following sizes:

- 3 x 5 x 12 mm
- 4 x 5 x 12 mm
- 3 x 6.5 x 15.3 mm
- 4 x 6.5 x 15.3 mm
- 4 x 7.5 x 18 mm
- 5 x 7.5 x 18 mm
- 5 x 9 x 21 mm
- 6 x 9 x 21 mm



Description

80-piece

Part no.

S8064

## Assortment of circlips



in a box, with the following sizes and shapes:

- 50-piece each, spring rings, star discs, support plates, inner dia. 3 mm
- 50-piece each, spring rings, star discs, support plates, inner dia. 4 mm
- 50-piece each, spring rings, star discs, support plates, inner dia. 5 mm
- 40-piece each, spring rings, star discs, support plates, inner dia. 6 mm
- 30-piece each, spring rings, star discs, support plates, inner dia. 8 mm
- 20-piece each, spring rings, star discs, support plates, inner dia. 10 mm



Description

720-piece

Part no.

S8066

## Assortment of synchroniser rings



in box, with the following contents:

- 300 units: 3,4,5 mm / each
- 150 units: 6 mm
- 100 units: 8 mm
- 50 units: 10 mm



**Description**  
1200-piece

**Part no.**  
**S8053**

## Assortment of body bolts and speed nuts



in a box, with the following sizes:

- 85 cross-slot screws  
40 each 3 x 8 mm  
20 each 4 x 16 mm  
15 each 15 x 12 mm  
10 each 6 x 20 mm
- 85 speed nuts  
20 each 3 x 8 mm  
20 each 3 x 11 mm  
20 each 4 x 11 mm  
15 each 5 x 13 mm  
10 each 6 x 12.5 mm



**Description**  
170-piece

**Part no.**  
**S8067**

## Nut assortment



galvanised, in a case

- Hex nuts
- Sizes M3 - 4 - 5 - 6 - 8 - 10



**Description**  
150-piece

**Part no.**  
**S8068**

## Assortment of nuts



self-locking, in box with the following contents:

- 35 x M4, 35 x M5, 25 x M6, 25 x M8, 16 x M10, 10 x M12



**Description**  
146-piece

**Part no.**  
**S8135**





## Washer assortment



galvanised, in a case

- 152 spring washers:  
80x4, 35x5, 15x6, 15x8 mm
- 98 flat washers:  
50x4, 25x5, 15x6, 15x8 mm



Description  
250-piece

Part no.  
**S8073**

## Assortment of crocodile clips



insulated and non-insulated, ideal for hobby and garage, composed for application on almost all vehicles, in box, assorted

- 10 x mini 50 mm
- 6 x 65 mm
- 2 x 80 mm
- 2 x 70 mm
- 6 x 55 mm
- 2 x 60 mm



Description  
28-piece

Part no.  
**S8138**

## Assortment of automotive fuses



- Mini FK1 - color-marked
- 20 each 5-10-15-20-25-30 A
- 1 fuse removal tool



Description  
121-piece

Part no.  
**S8115**

## Assortment of automotive fuses



- mid-FK2 color-marked
- 12 each 3-5-7.5-10-15-20-25-30 A
- 1 fuse removal tool



Description  
97-piece - midi FK 2

Part no.  
**S8116**

## Quick-action connector set



for producing branch cable connections e.g. when retrofitting trailer couplings and installing auxiliary headlights.  
Simple to use – pressing the metal element down cuts into the insulation of the two cables to be connected. The plastic cap provides additional insulation for the connecting element.

Contains:

- 25 connectors for 0.5 – 1.5 mm<sup>2</sup> cable cross-section
- 25 connectors for 1.5 – 2.5 mm<sup>2</sup> cable cross-section



Description

50-piece

Part no.

S8120

## E-circlip set



in box, with the following sizes:

- 30 x 1.5 mm
- 30 x 3.0 mm
- 40 x 5.0 mm
- 50 x 6.0 mm
- 50 x 10 mm
- 40 x 12 mm
- 20 x 15 mm
- 20 x 19 mm
- 20 x 22 mm



Description

300-piece

Part no.

S8039

## Assortment of rubber grommets



in a box, with the following sizes:

- 40 x 10 mm
- 40 x 9 mm
- 40 x 6 mm
- 20 x 12 mm
- 25 x 11 mm
- 5 x 24 mm
- 5 x 21 mm
- 5 x 16 mm



① Ideal for all cable operations, e.g. engine compartment, tow coupling etc.

Description

180-piece

Part no.

S8112

## Blind rivet assortment



aluminium, in cartridge

- about 37 mm long
- sizes 2.4 - 3.2 - 4 - 4.8

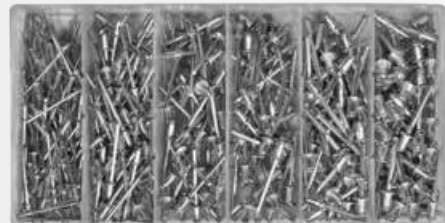

Description

400-piece

Part no.

S8058

## Grease nipple assortment



chrome plated, in a box

Size:

- M6 x 1, M8 x 1, M10 x 1 (straight / 45° / 90°)



Description

110-piece

Part no.

S8065





## Empty box



for consumables.

With 18 compartments.  
Interior dimension 205 x 100 mm



Part no.  
**S8100**

## Cable lug assortment



- for cable diameter 1,5 / 2,5 / 6 mm<sup>2</sup>
- wire cross section:
  - 0,5 - 1,5 mm<sup>2</sup> (red),
  - 1,0 to 2,5 mm<sup>2</sup> (blue),
  - 2,5 to 6 mm<sup>2</sup> (yellow)
- crimp connector for 1,5 mm<sup>2</sup> + 2,5 mm<sup>2</sup>
- cable lug female round + flat
- cable lug male round + flat
- cable lug for multi-connections
- cable lug, open for 5-mm screws
- cable lug for screws + stud bolts 4 + 5 mm round
- cable lug for screws + stud bolts 5 + 6 mm round



Description  
100-piece

Part no.  
**S3180**

## Cable binder assortment



- for organising, attaching, bundling and sorting
- in 3 different sizes, 25 x 100 mm / 25 x 120 mm / 25 x 200 mm



Description  
75-piece

Part no.  
**42511SB**





# MOTORCYCLE

A close-up photograph of motorcycle engine components, including a timing cover with a red and white scale, a metal bracket, and several brass-colored threaded parts with knurled sections. The image is overlaid with a semi-transparent blue banner at the top containing the word 'MOTORCYCLE' in white, bold, sans-serif capital letters.



## ► Special Tools

732-737





## Ratchet wrench set



Chrome vanadium S2 special steel. The S-type shaped ratchet wrench has a 6.3 mm (1/4") hex bit drive and a 6.3 mm (1/4") square drive for socket wrench with an insert stop, fine toothed 72 teeth, left/right reversible.

- extension in length 50 mm
- cardan joint
- bit holder
- T-profile bits 10-15-20-25-27-30
- inner hex bits 3-4-5-6-8 mm
- plain slot bits 4,5-5,5-7 mm
- cross slot bits PH1-PH2-PH3
- Pozidrive bits PZ1-PZ2-PZ3
- socket wrench inserts 6.3 mm (1/4")  
5 - 6 - 7 - 8 - 9 - 10 - 11 - 12 - 13 mm



**Description**  
33-piece

**Part no.**  
36015L

## Special tool set for motorbikes



for all standard models.

- Multi-purpose retaining tool, adjustable with four pin wrenches 5 + 9 mm
- Chain separating press with replacement top
- Crankshaft pull-in tool with two threaded adapters M10, M12
- Rotor removal tool set M14 x 1.5 / M16 x 1.5 / M24 x 1.0 / M27 x 1.0 (left-hand thread) / M28 x 1.0
- Pin wrench bit 17 mm diameter, 4 pins
- Valve setting tool set 8 and 9 mm spanner socket, 40 mm long
- Valve mandrel with 3 mm square socket
- Impact mandrel for valve separators
- Double hook wrench with two multi-purpose widths
- Two coupling pin keys with 12.5 mm (1/2") socket drive in 20 and 24 mm Ø and four pins

Bits and accessories for 6.3 mm (1/4") hex drive:

- Bit screwdriver + T-handle + 6.3 mm (1/4") bit adapter
- Hexagonal socket spanner 8 + 10 mm, length 100 mm
- Double-blades of different lengths and shapes: 60 mm PH1, 100 mm PH2 + PH3 (inner hex 5 + 6 mm), 200 mm PH2 (inner hex 4 + 5 mm), 300 mm PH3



**Description**  
30-piece

**Part no.**  
08500L

## Pole wheel remover set



suitable for Yamaha, Honda, Suzuki, Bosch, Kwasaki, Ducati and many more.

Sizes contained:

- M14 x 1.5, M25 x 1.5, M22 x 1.5, M16 x 1.5, M22 x 1.0, M27 x 1.25, M18 x 1.5, M28 x 1.5, M20 x 1.0, M26 x 1.0, M19 x 1.0, M27 x 1.0, M28 x 1.0, M26 x 1.5, M24 x 1.0



**Honda  
Suzuki  
Yamaha  
Ducati  
Kawasaki**

**Description**  
10-piece

**Part no.**  
05270L

## Universal clutch and rotor holder



especially for motor scooters.

- With coated contact surface for holding rotors, Variomatic, clutches etc. in place.



### Description

50 - 120 mm Diameter clamping range

### Part no.

410131L

## Universal clutch and rotor holder



especially for motor scooters.

- For holding rotors, Variomatic, clutches etc. in place



### Description

60 - 250 mm Diameter clamping range

### Part no.

410132L

## Synchronous carburetor tester



For synchronous measurement of 2 - 4 carburetors

- 4 manometers, mounted on board
- 4 rubber hoses 8 x 5 x 750 mm
- 4 hose clamps + replacement sealing rings
- 4 connectors 53 mm (M6x0.75)
- 4 connectors 60 mm (M6x1.00)
- 4 extensions 3.9 x 52 mm
- 4 extensions 3.9 x 122 mm
- Suitable for motorbikes and passenger cars.



### Engine-type

Petrol

### Part no.

26093L

## Ignition timing and TDC finder adjustment set



ideal for the exact adjustment of the ignition timing or finding the top dead centre with two or four-stroke engines. Essential for engines with breaker contacts.

Contains:

- gauge (0.01 mm = 1/100 mm scale line, measuring range: 0–8 mm)
- 3 spark plug thread adapters M10 x 1.0 / M12 x 1.25 / M14 x 1.25
- two extensions for gauge 83 mm / 50 mm
- gauge holder with knurled screw 46 mm
- gauge holder extension 50 mm



### Description

8-piece

### Part no.

26118L





## Digital ignition timing gun



(stroboscope) for 12 Volt systems in 2, 3, 4, 5, 6, 8-cylinder engines. Can be used for 4-stroke distributor ignition systems, 2-stroke and twin-spark ignition systems.

With xenon lamp, red and black cable clamps for the power supply, inductive clamp and green crocodile clip for measuring speed, closing angle and for the voltage test.

- perfect setting of ignition from 0 to 60°
- closing angle test from 0 – 99.9% with conversion table
- engine speed counter from 200 – 9999 rpm
- voltage drop test
- voltmeter



Part no.  
**32229L**

## Contact file



e.g. for cleaning spark-plug contacts



Length  
150 mm

Part no.  
**93605L**

## Spark plug brush



made of brass wire, for gentle cleaning of the spark plug electrode.



Length  
150 mm

Part no.  
**93900L**

## Valve spring tool set



especially for motorbikes

- Valve spring clamping range 125 mm
- Four pressure pads for the valve spring discs 16, 18, 21, 23 mm diameter
- Two adapters for deep-seated valve spring discs 16, 21 mm diameter
- Valve separator mandrel with spring
- Valve setting mandrel with 3 mm square socket and three hexagon spanner sockets, long, 8, 9, 10 mm
- Removal tool for piston rod with four sleeves 13, 15, 16, 19 mm diameter



Description  
17-piece

Part no.  
**41230L**

## Swingarm pivot tool set

for the removal and fitting of swingarm pivots on motorbikes e.g. Honda, Kawasaki, Suzuki, Yamaha from model year 1990 to 2000.

- One threaded spindle 207 mm long, M12 x 1.25
- One roller bearing for easier drive
- Two nuts M12 x 1.25 mm, SW 19 mm
- Two pressure pads, 1 x 38 mm and 1 x 50.8 mm diameter
- Three pull-in sleeves 50.8 mm long  
27 outer-Ø / 22 inner-Ø mm  
26 outer-Ø / 21 inner-Ø mm  
26 outer-Ø / 20 inner-Ø mm



Kawasaki  
Honda  
Suzuki  
Yamaha



Description

9-piece

Part no.

10033L

## Special steering head bearing removal set

chrome-plated with percussion hammer for knocking in and out the steering head bearing shells on motorbikes in and out.

- Slide handle for percussion hammer 515 mm long
- 1.5 kg percussion hammer
- Nut size 22 mm
- Two spread adapters 26-32 mm and 29-36 mm (for removal)
- Two pressure sleeves with 26, 28, 30, 30.5 mm Ø (for knocking in)



Description

7-piece

Part no.

10036L

## Jointed hook spanner

adjustable from 35 - 60 mm

For use on groove nuts DIN 1804 - also ideal for adjusting steering head bearings on motorcycles



Length

175 mm

Part no.

S1226

## Lock-ring drive-in set

Makes it easier to mount lock-rings correctly on standard and upside down forks.

Due to the high dead load of the single insertions, a fast installation of the lock-rings is possible without damaging the surface or impairing the seal seat.

The insertion tools are divided in two and suitable for the following fork diameters:

- 35/36, 39, 41, 43, 45, 46/47, 48, 49/50, 54 mm



Description

9-piece

Part no.

10037L



## Chain separating and riveting tool



for separating and riveting chain links (pitch 35-530) on roller chains.  
Also suitable for bicycle and motorcycle chains.

- 3 separating tips for different scopes of application are included:
- 2,2 mm - for chains according to Ansi 25 / DIN-ISO 04 (standard timing chain)
  - 2,9 mm - for chains according to Ansi 35 / DIN-ISO 06
  - 3,8 mm - for motorcycle chains according to standard 428 - 530

⚠ **Separation of high performance chains 530 or higher only after abrasion of the rivet head!**



Description	Part no.
13-piece	10590L

## Special socket



for removing the axle shaft on motorbikes  
Inner hexagon profile 19 - 24 - 22 mm  
Depending on the diameter of axle shaft required,  
the socket is driven with a socket spanner 19 / 22 mm

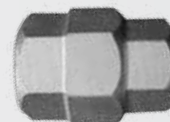

**BMW**  
**Honda**  
**Yamaha**  
**Ducati**  
**Kawasaki**  
**Moto Morini**

Description	Part no.
	05113L

## Spoke wrench



for the precise and fast adjustment of motorbike spokes with six standard nipple sizes:

- 4.5 mm, 5.0 mm, 5.3 mm, 5.6 mm, 6.0 mm, 6.4 mm).



Suitable for:  
all MX and Endurobikes

Description	Part no.
	02109L

## Special rotational handle angled screwdriver set



with 90° pivoted bevel gear for the precise adjustment of air or mixture setting screws that are difficult to access, e.g. motorbike carburettors, which would result in time-consuming dismantling work. Transmission ratio 1:1 (one turn of the handle equals one turn of the screw).

- Angled screwdriver including add-on piece with handle length: 485 mm (add-on piece with 5x0.8mm slot blade)
- Removable screwdriver head for plain slot or cross-slot bits
- 5 plain slot screwdriver bits (blade tip 5 x 0.8 mm) 21, 24, 28, 35, 58 and 95 mm
- 2 cross-slot bits (up to M5) 35 mm, 58 mm
- Additional handle for better guiding



Description	Part no.
10-piece	30060L

## Hand-held impact wrench set



in metal box, with 2 cross and 2 plain slot blades each



Description	Part no.
5-piece, workshop model	04103L
5-piece, standard model	04100L



## Power bit, Cross



for hand-held impact wrench with 8 mm socket, e.g. 04100L, 04103L, 04130L, 05040L



Description	Profile	Size	Length	Part no.
Power bit	⊕	PH 2	36 mm	<b>04100L-K2</b>
Power bit	⊕	PH 3	36 mm	<b>04100L-K3</b>

## Motorbike wheel clamp holder



sturdy, safe stance thanks to 4 rubberized feet e.g.: for parking in the garage or transporting in trailer. Also suitable for permanent attachment through pre-drilled holes.

- for 16 – 21" wheels
- for tyre width up to 130 mm



① Through pre-drilled holes also suitable for fixed installation

Part no.  
**20820L**



# COMMERCIAL VEHICLES





# COMMERCIAL VEHICLES

# 738-797



- ▶ **Spanners** 740-743
- ▶ **Sockets / Ratchets / Accessories** 744-752
- ▶ **Screwing Tools** 753-760
- ▶ **Hammers / Chisels / Punches** 760-762
- ▶ **Pliers** 762-767
- ▶ **Air Tools** 767-771
- ▶ **Torque Tools** 772-775
- ▶ **Engine** 775-779
- ▶ **Wheel and Brake** 779-785
- ▶ **Steering / Suspension** 785-794
- ▶ **Electrics** 795-796





## Combination spanner set, Extra long



Chrome-vanadium, matt chrome-plated, finely polished, in black roll-up pouch.

- Extra long version enables high power transmission
- Hardness and torque exceed the requirements of the relevant DIN standards



**Description**  
6-piece,  
21, 22, 24, 27, 30, 32 mm

**Part no.**  
**00835L**

## Combination wrench, Extra long



Chrome-vanadium, chromium-plated and high-gloss polished

- Extra-long design for maximum power transmission
- Hardness and torque exceed the requirements of the relevant DIN standards



Size	Length	Part no.
21 mm	300 mm	00835L-21
22 mm	310 mm	00835L-22
24 mm	335 mm	00835L-24
27 mm	355 mm	00835L-27
30 mm	420 mm	00835L-30
32 mm	440 mm	00835L-32

## Combination spanner set, Extra long



Jumbo combination spanner set, maximum material strength, suitable for use on trucks. In black roll-up pouch.

- Spanner size 34 x 440 mm long
- Spanner size 36 x 445 mm long
- Spanner size 38 x 470 mm long
- Spanner size 41 x 495 mm long
- Spanner size 46 x 540 mm long
- Spanner size 50 x 600 mm long



**Description**  
6-piece (34, 36, 38, 41, 46, 50 mm)

**Part no.**  
**00927L**

## Combination wrench, Extra long



Jumbo combination wrench, extra-strong, for use on commercial vehicles



Description	Part no.
SW 34 x 440 mm	00927L-34
SW 36 x 445 mm	00927L-36
SW 38 x 470 mm	00927L-38
SW 41 x 495 mm	00927L-41
SW 46 x 540 mm	00927L-46
SW 50 x 600 mm	00927L-50
SW 55 x 620 mm	00927L-55

## Combination ratchet wrench



Chrome-vanadium, matt chrome-plated, finely toothed with 72 teeth.



Size	Length	Height	Part no.
8 mm	135 mm	8 mm	S1595-8
9 mm	155 mm	8 mm	S1595-9
10 mm	155 mm	9 mm	S1595-10
11 mm	165 mm	9 mm	S1595-11
12 mm	165 mm	9 mm	S1595-12
13 mm	175 mm	9 mm	S1595-13
14 mm	185 mm	9 mm	S1595-14
15 mm	200 mm	10 mm	S1595-15
16 mm	206 mm	10 mm	S1595-16
17 mm	222 mm	10 mm	S1595-17
18 mm	237 mm	10 mm	S1595-18
19 mm	247 mm	10 mm	S1595-19
21 mm	280 mm	13 mm	S1595-21
22 mm	280 mm	13 mm	S1595-22
24 mm	308 mm	13 mm	S1595-24
27 mm	326 mm	15 mm	S1595-27
30 mm	425 mm	18 mm	S1595-30
32 mm	425 mm	18 mm	S1595-32

## Double-ring spanner, Extra long



- chrome-vanadium
- extra-long
- straight version
- mirror-polished
- high-strength, e.g. for supporting joints, steering knuckle screw attachments, propeller shaft flanges (also for trucks before towing)

Mercedes-Benz LKW  
Iveco LKW  
General Motors LKW  
Fiat LKW  
Volvo LKW  
Scania LKW  
Mitsubishi LKW



Description	Length	Height	Part no.
10 x 11 mm	320 mm	10 mm	01351L
12 x 14 mm	330 mm	11 mm	01352L
13 x 15 mm	365 mm	14 mm	01353L
17 x 19 mm	395 mm	16 mm	01354L
16 x 18 mm	365 mm	14 mm	01357L
21 x 23 mm	435 mm	18 mm	01356L
22 x 24 mm	435 mm	18 mm	01355L

## Open ring spanners



on clamping rail, ideal for injection lines, air-conditioning systems, brake lines, compressed air and hydraulic lines, power steering 10 mm (3/8") drive.



Description	Part no.
10-piece, 10-11-12-13-14-15-16-17-18-19 mm	01480L



## Open-ended ring spanner



ideal for injection lines, air conditioning systems, brake lines, compressed air and hydraulic lines and the power steering 10 mm (3/8") drive.



Size	Part no.
10 mm	01480L-10
11 mm	01480L-11
12 mm	01480L-12
13 mm	01480L-13
14 mm	01480L-14
15 mm	01480L-15
16 mm	01480L-16
17 mm	01480L-17
18 mm	01480L-18
19 mm	01480L-19

## Open ring spanners



on clamping rail, ideal for injection lines, air-conditioning systems, brake lines, compressed air and hydraulic lines, oil pressure switches, 12,5 mm (1/2") drive

MAN LKW  
Mercedes-Benz LKW

- 20, 21, 22, 23, 24, 25, 26, 27, 28, 30, 32 mm
- extention 125 mm
- breaker bar 385 mm



Description	Part no.
13-piece	01490L
Empty case	01490L-KOFFER

## Open ring spanner

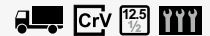

ideal for injection lines, air-conditioning systems, brake lines, compressed air and hydraulic lines, oil pressure switches, 12,5 mm (1/2") drive



Size	Part no.
20 mm	01490L-20
21 mm	01490L-21
22 mm	01490L-22
23 mm	01490L-23
24 mm	01490L-24
25 mm	01490L-25
26 mm	01490L-26
27 mm	01490L-27
28 mm	01490L-28
30 mm	01490L-30
32 mm	01490L-32

## Open ring spanner



e.g. for compressed air and hydraulic lines, 12,5 mm (1/2") drive.



Size	Part no.
33 mm	01495L-33
38 mm	01495L-38
41 mm	01495L-41
46 mm	01495L-46
50 mm	01495L-50

## Adjustable spanner



with plastic soft handle, matt nickle-plated, millimetre scale



Description	Length	Part no.
10"	250 mm	00712L

## Slogging ring wrench, Double hexagon



manufactured according to DIN 7444

- For use with heavy assemblies in particular
- made from high-quality chrome vanadium steel
- burnished



Size	Length	Part no.
27 mm	180 mm	00257L
30 mm	196 mm	00258L
32 mm	196 mm	00262L
36 mm	205 mm	00264L
41 mm	229 mm	00265L
46 mm	239 mm	00266L
50 mm	256 mm	00267L
55 mm	271 mm	00269L
60 mm	280 mm	00270L
65 mm	300 mm	00271L
70 mm	326 mm	00272L
75 mm	326 mm	00273L
80 mm	357 mm	00274L
85 mm	359 mm	00275L
90 mm	400 mm	00276L
95 mm	400 mm	00279L

## Open-ended slogging wrench



manufactured according to DIN 133

- For use with heavy assemblies in particular
- made from high-quality chrome vanadium steel
- burnished



Size	Length	Part no.
27 mm	180 mm	00280L
30 mm	190 mm	00281L
32 mm	195 mm	00285L
36 mm	215 mm	00287L
41 mm	235 mm	00288L
46 mm	255 mm	00289L
50 mm	280 mm	00290L
55 mm	310 mm	00291L
60 mm	330 mm	00292L
65 mm	345 mm	00293L
70 mm	370 mm	00294L
75 mm	395 mm	00295L
80 mm	405 mm	00296L
85 mm	405 mm	00297L
90 mm	455 mm	00298L
95 mm	455 mm	00299L





## 5-star screwdriver bits sockets, 5 Star with hole



9-piece set, with hole at the end, chrome-vanadium, for VAG, Ford, Volvo, Mercedes-Benz, passenger cars and trucks, Rover etc.

Audi  
Ford  
Mercedes-Benz  
Mercedes-Benz LKW  
Rover  
Seat  
Škoda  
VW  
Volvo  
Volvo LKW

- generator
- engine control
- air flow meter
- door panelling
- immobiliser
- unit pumps



T10 - T15 - T20 - T25 - T27 - T30 - T40 - T45 - T50

Description	Profile	Part no.
9-piece		IP/4-SET

## Screwdriver bit, 5 Star with hole



with hole at the end, chrome-vanadium  
For generator, engine control, air flow meter, door panelling in VAG, Ford, Volvo, Daimler-Benz as well as unit pumps on agricultural machines and Daimler-Benz Actros

Audi  
Ford  
Mercedes-Benz  
Mercedes-Benz LKW  
Seat  
Škoda  
VW  
Rover



Profile	Size	Part no.
	IP 10	IP/4-T10
	IP 15	IP/4-T15
	IP 20	IP/4-T20
	IP 25	IP/4-T25
	IP 27	IP/4-T27
	IP 30	IP/4-T30
	IP 40	IP/4-T40
	IP 45	IP/4-T45
	IP 50	IP/4-T50

## Screwdriver bits, T profile without hole, Long



5-piece set, without tamperproof feature, chrome-vanadium

T60 - T70 - T80 - T90 - T100



Description	Profile	Length	Part no.
5-piece		80 mm	05380L

## Screwdriver bit, T profile without hole, Long



without tamperproof feature, chrome-vanadium



Profile	Size	Length	Part no.
	T 60	80 mm	05348L
	T 70	80 mm	05349L
	T 80	80 mm	05381L
	T 90	80 mm	05382L
	T 100	80 mm	05383L



## IMPACT special bit set



Chrome-molybdenum suitable for use with impact wrench. This range is universally suitable for mounting and dismantling work on cylinder head screws, brake calliper screws, steering columns (e.g. Actros), wheel flange screws, oil draining screws, bumper, etc.  
Bits with 22 mm hexagon drive and the following profiles:

- T-profile T60, T70, T80, T90, T100
- Inner hexagon 17, 19, 22, 24 mm
- Outer E-profile E18, E20, E22, E24

Additional bit holder with 20 mm (3/4") and 25 mm (1") drive as well as 1 allen key for locking the bits in the holder grub screw



Mercedes-Benz LKW  
DAF  
Iveco LKW  
MAN LKW



Description	Part no.
16-piece	07940L

## Special bits



Chrome-vanadium, hardened, matt chrome-plated

- slotted bits in 10, 11, 12, 14, 17 and 19 mm
- for fitting temperature sensors, thermal switches and other components with cables at the top and at the side
- also suitable for screw connections for angled pipes
- the slot width is: 7.4 mm - 8.5 mm - 9.1 mm - 10.5 mm - 13 mm and 14.4 mm
- incl. metal rail



Description	Part no.
6-piece	01482L

## Socket inserts, E Profile, Extra long



for E-profile screws, extra thin-walled and 150 mm long,  
• E10 - E12 - E14 - E16 - E18 - E20

E10 e.g. For door hinge bolts on sides and levers of Mercedes-Benz Sprinter and identical LT to '05  
E12 e.g. For cylinder head bolts BMW 90 without removing the camshaft as well as adjustment of the engine settings for Vauxhall /Opel vehicles, MAN valve covers  
E14 e.g. For drive shafts Mercedes-Benz S-Class, cylinder head Vauxhal / Opel, Audi V6 as Audi 80 with ABS, BMW rear axle bearing unit  
E16 e.g. For cylinder head bolts Mercedes-Benz A-Class at 1.4l and 1.7l Diesel  
E18 e.g. For the brake caliper fitting on MAN commercial vehicles  
E20 e.g. For the cylinder head bolts on MAN commercial vehicles



BMW  
Mercedes-Benz  
VW  
MAN  
Audi  
Opel

① E12 loosens BMW cylinder head screws without removal of the camshaft

Description	Profile	Length	Part no.
6-piece, E10-E12-E14-E16-E18-E20	★	150 mm	05685L

## Industrial tool case, Hexagonal



20 mm (3/4") drive

- Ratchet wrench 500 mm
- Extensions 100 - 200 mm
- Sliding handle 450 mm
- Hexagon sockets 19 - 22 - 24 - 27 - 30 - 32 - 36 - 38 - 41 - 46 - 50 mm



Description	Profile	Part no.
15-piece	◆	07650L



## Industrial tool case, Hexagonal



20 mm (3/4") drive, hardness and torque according to DIN

- Ratchet wrench 500 mm
- Extensions 100 - 200 - 400 mm
- Sliding handle 450 mm
- Hexagon sockets 19 - 21 - 22 - 23 - 24 - 26 - 27 - 29 - 30 - 32 - 34 - 36 - 38 - 41 - 46 - 50 mm



### Description

### Profile

### Part no.

21-piece



**07660L**

Empty case

**07660L-KOFFER**

## Spanner socket, Hexagonal

Chrome-vanadium, chrome-plated



### Description

### Size

### Length

### Part no.

19 mm

50 mm

**07660L-19**

21 mm

50 mm

**07660L-21**

22 mm

50 mm

**07660L-22**

23 mm

50 mm

**07660L-23**

24 mm

50 mm

**07660L-24**

26 mm

50 mm

**07660L-26**

27 mm

52 mm

**07660L-27**

28 mm

52 mm

**07660L-28**

30 mm

54 mm

**07660L-30**

32 mm

56 mm

**07660L-32**

33 mm

56 mm

**07660L-33**

34 mm

57 mm

**07660L-34**

36 mm

58 mm

**07660L-36**

38 mm

62 mm

**07660L-38**

41 mm

64 mm

**07660L-41**

special socket for Citroën drive shafts

44 mm

70 mm

**07660L-44**

46 mm

70 mm

**07660L-46**

50 mm

73 mm

**07660L-50**

## Sliding handle

Chrome-vanadium, matt chrome-plated



### Length

450 mm

### Part no.

**07660L-9**

## Extension

Chrome-vanadium

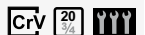

### Length

200 mm

### Part no.

**07660L-5**





## IMPACT spanner sockets, Hexagonal, Short



suitable for use with impact wrench, with groove and bore hole, 20 mm (3/4") drive

22 - 24 - 27 - 28 - 30 - 32 - 36 - 38 mm



① short version

Description	Profile	Part no.
8-piece	◆	07900L

## IMPACT spanner socket, Hexagonal, Short



Suitable for use with impact wrench, chrome-molybdenum steel, with groove and bore hole for ball, burnished



Size	Length	Part no.
17 mm	50 mm	07900L-17
18 mm	50 mm	07900L-18
19 mm	50 mm	07900L-19
22 mm	50 mm	07900L-22
24 mm	50 mm	07900L-24
27 mm	55 mm	07900L-27
30 mm	55 mm	07900L-30
32 mm	55 mm	07900L-32
33 mm	55 mm	07900L-33
36 mm	55 mm	07900L-36
41 mm	57 mm	07900L-41
46 mm	63 mm	07900L-46
50 mm	68 mm	07900L-50
55 mm	74 mm	07900L-55

## IMPACT extension

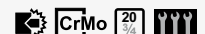

Suitable for use with impact wrench, chrome-molybdenum steel, burnished



Length	Part no.
175 mm	07900L-175

## IMPACT extension

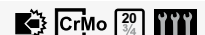

Suitable for use with impact wrench, chrome-molybdenum steel, burnished

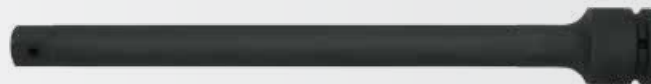

Length	Part no.
400 mm	07900L-400

## Locking ring



for 20 mm (3/4") IMPACT bits and extensions



Part no.
07900L-RING

## Locking pin



for 20 mm (3/4") IMPACT bits and extensions

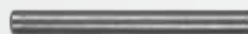

Part no.

07900L-STIFT

## IMPACT spanner sockets, Hexagonal, Long



8-piece set, suitable for use with impact wrench, with groove and bore hole, 20 mm (3/4") drive

22 - 24 - 27 - 28 - 30 - 32 - 36 - 38 mm



① Long version

Description	Profile	Part no.
8-piece	◆	07910L

## IMPACT spanner socket, Hexagonal, Long



Suitable for use with impact wrench, with groove and bore hole, burnished



Description	Size	Length	Part no.
	19 mm	95 mm	07910L-19
	22 mm	90 mm	07910L-22
	24 mm	90 mm	07910L-24
	27 mm	90 mm	07910L-27
	30 mm	90 mm	07910L-30
	32 mm	90 mm	07910L-32
	36 mm	90 mm	07910L-36
including for Ford Sierra + Opel Zafira wheel hub	41 mm	90 mm	07910L-41
	46 mm	95 mm	07910L-46
	50 mm	90 mm	07910L-50

## IMPACT screwdriver bits, Hexagonal socket



Chrome-molybdenum steel, suitable for impact screwdrivers, with groove and bore hole

- Hexagon socket profile 14, 17, 19, 21, 22, 23, 24 mm
- Inner multipoint with bore hole M16 + M18



VW  
Mercedes-Benz  
Audi  
Seat  
Mercedes-Benz LKW

Description	Part no.
9-piece	07942L

## IMPACT screwdriver bit, Hexagonal socket, Extra long



special length, for mounting retaining screws on the upper wishbone on rear axles on MAN types TGA and F2000



MAN LKW

Profile	Size	Length	Part no.
○	17 mm	170 mm	10111L



## Industrial tool case, Hexagonal

25 mm (1" drive), chrome-vanadium



- lever-type ratchet wrench head 200 mm
- extensions 200 + 400 mm
- ratchet handle 550 mm
- sliding block
- inserts 36, 38, 41, 50, 55, 60, 65, 70, 75, 80 mm



Description

Part no.

16-piece

07675L

## Socket spanner bit, Hexagonal, Short

Chrome-vanadium, high gloss chromium-plated



Size

Length

Part no.

36 mm

55 mm

07675L-36

41 mm

55 mm

07675L-41

46 mm

65 mm

07675L-46

50 mm

75 mm

07675L-50

55 mm

80 mm

07675L-55

60 mm

85 mm

07675L-60

65 mm

90 mm

07675L-65

70 mm

95 mm

07675L-70

75 mm

100 mm

07675L-75

80 mm

100 mm

07675L-80

## Extension

Chrome-vanadium, high gloss chromium-plated



Length

Part no.

200 mm

07675L-1

## Extension

Chrome-vanadium, high gloss chromium-plated



Length

Part no.

400 mm

07675L-2

## IMPACT sockets, Hexagonal

8-piece set, 1" drive, chrome-molybdenum, length 58 - 80 mm, high-strength version, with groove and bore



Spanner size 27, 30, 32, 36, 38, 41, 46, 50



Description

Part no.

8-piece

07980L

## IMPACT spanner socket, Hexagonal, Long



Suitable for use with impact wrench, chrome-molybdenum steel, with groove and bore hole



Size	Length	Part no.
24 mm	100 mm	07980L-24
27 mm	100 mm	07980L-27
30 mm	90 mm	07980L-30
32 mm	100 mm	07980L-32
36 mm	90 mm	07980L-36
39 mm	100 mm	07980L-39
41 mm	90 mm	07980L-41
46 mm	100 mm	07980L-46
55 mm	100 mm	07980L-55
60 mm	120 mm	07980L-60
65 mm	125 mm	07980L-65
70 mm	125 mm	07980L-70

## IMPACT spanner socket, Hexagonal, Short



Suitable for use with impact wrench, chrome-molybdenum steel, with groove and bore hole



Size	Length	Part no.
22 mm	60 mm	07985L-22
24 mm	60 mm	07985L-24
27 mm	60 mm	07985L-27
30 mm	63 mm	07985L-30
32 mm	61 mm	07985L-32
33 mm	63 mm	07985L-33
36 mm	65 mm	07985L-36
41 mm	70 mm	07985L-41
46 mm	76 mm	07985L-46
50 mm	68 mm	07985L-50
55 mm	75 mm	07985L-55
60 mm	87 mm	07985L-60
65 mm	90 mm	07985L-65

## IMPACT extension



Suitable for use with impact wrench, chrome-molybdenum steel, burnished



Length	Part no.
175 mm	07985L-175

## IMPACT extension



Suitable for use with impact wrench, chrome-molybdenum steel, burnished

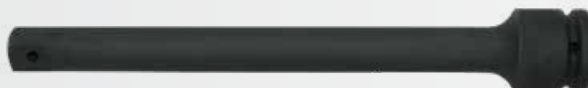

Length	Part no.
330 mm	07985L-330





## Locking pin



for 25 mm (1") IMPACT bits and extensions



ⓘ To be used with 07985L-RING

Part no.  
07985L-STIFT

## Locking ring



for 25 mm (1") IMPACT bits and extensions



ⓘ To be used with 07985L-STIFT!

Part no.  
07985L-RING

## Lever ratchet handle



removable head

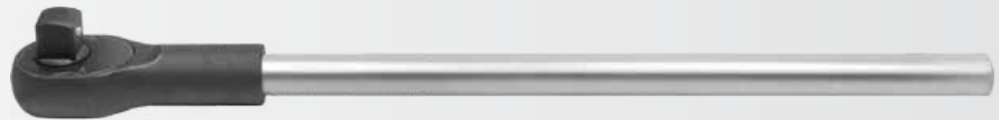

Length  
675 mm

Part no.  
05959L

## IMPACT spanner socket, Hexagonal



1" drive, e.g for bolting kingpins



Description	Profile	Size	Part no.
	●	85 mm	10322L
	●	95 mm	10323L
DAF rear axle brake	●	105 mm	10324L

## Screwdriver set, T profile without hole



chrome-vanadium,

T 6 - 7 - 8 - 9 - 10 - 15 - 20 - 25 - 27 - 30 - 40



Description	Profile	Part no.
11-piece	⊕	31505L



## Screwdriver set



- with 2-component handle, blue / black, blade chrome-plated from CV-S2 steel
- with hole in handle for torque reinforcement
- durable by twist-resistant connection of blade and handle
- optimal torque transmission due to ergonomic and non-slip grip
- with black, magnetic tip



Description	Part no.
6-piece, 3+4+5,5+6,5, PH 1+2	31810L
5-piece, 2+3+4+5,5+6,5	31811L
6-piece, T 10+15+20+25+27+30	31812L
4-piece, T 6+7+8+9	31813L
5-piece, 2, PH 0+1+2+3	31814L
6-piece, 4+5,5, PZ 1+2, T 20+25	31815L
6-piece, 4+6,5, PH 1+2, PZ 1+2	31817L

## Workshop screwdriver set



with 2-component handle, black/grey Blade made of CV steel, with forged hexagon drive

- Good to hold thanks to torsion-resistant connections between blade and handle
- Low-fatigue screwing and optimum torque transmission through ergonomic handle shape



Description	Part no.
5-piece, Slot 3,5 x 75 mm, 5,5 x 100 mm, 6,5 x 125 mm, PH 1+2	31455L
6-piece, Slot 3,5 x 75 mm, 5,5 x 100 mm, 6,5 x 125 mm, PH 1+2+3	31456L

## Workshop screwdriver set, T profile without hole



with 2-component handle, black/grey Blade made of chrome-molybdenum steel.

- Good to hold thanks to torsion-resistant connections between blade and handle
- Low-fatigue screwing and optimum torque transmission through ergonomic handle shape



Description	Profile	Part no.
8-piece, T8 - T10 - T15 - T20 - T25 - T27 - T30 - T40		31457L

## Screwdriver set, T profile with hole

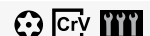

8-piece, chrome-vanadium, 2-component handle

T 8 - 10 - 15 - 20 - 25 - 27 - 30 - 40



Description	Profile	Part no.
8-piece		31500L





## Screwdriver set, 5 Star with hole

e.g. for unit pumps on Mercedes-Benz trucks (Actros and Atego), air flow meters on VAG vehicles, spare wheel holders, instrument and interior panelling



Audi  
Mercedes-Benz LKW  
Seat  
Škoda  
VW

Description	Profile	Part no.
8-piece	★	31510L

## Screwdriver, Slot



- with 2-component handle, blue/black, blade matt chrome-plated made of CV-S2 steel, black tip
- with hole in handle for increasing torque
- durable through anti-twisting connection of blade and handle
- optimum torque transmission through ergonomic and non-slip handle shape



Description	Profile	Part no.
2,0 x 63 mm	⊖	31752SB
3,0 x 80 mm	⊖	31753SB
4,0 x 100 mm	⊖	31754SB
5,5 x 125 mm	⊖	31755SB
6,5 x 150 mm	⊖	31756SB

## Garage screwdriver, Slot



**Racing Experience**, with dual-component shaft, black/grey, blade made of CV steel, with forged-on hex

- Durable owing to anti-twist connections between blade and handle
- Fatigue-free operation of the screwdriver and ideal torque transmission thanks to the ergonomic shape of the handle



Description	Profile	Part no.
3,5 x 75 mm	⊖	31411L
4,5 x 90 mm	⊖	31415L
5,5 x 100 mm	⊖	31412L
6,5 x 125 mm	⊖	31413L
8,0 x 150 mm	⊖	31414L

## Screwdriver, Cross



- with 2-component handle, blue/black, blade matt chrome-plated made of CV-S2 steel, black tip
- with hole in handle for increasing torque
- durable through anti-twisting connection of blade and handle
- optimum torque transmission through ergonomic and non-slip handle shape



Description	Profile	Part no.
PH0 x 60 m	⊕	31760SB
PH1 x 80 mm	⊕	31761SB
PH2 x 100 mm	⊕	31762SB
PH3 x 150 mm	⊕	31763SB

## Garage screwdriver, Cross



**Racing Experience**, with dual-component shaft, black/grey, blade made of CV steel, with forged-on hex

- Durable owing to anti-twist connections between blade and handle
- Fatigue-free operation of the screwdriver and ideal torque transmission thanks to the ergonomic shape of the handle



Description	Profile	Part no.
PH 1	⊕	31401L
PH 2	⊕	31402L
PH 3	⊕	31403L

## Screwdriver, T profile without hole



- with 2-component handle, blue/black, blade matt chrome-plated made of CV-S2 steel, black tip
- with hole in handle for increasing torque
- durable through anti-twisting connection of blade and handle
- optimum torque transmission through ergonomic and non-slip handle shape



Description	Profile	Part no.
T6 x 60 mm	⊕	31706SB
T7 x 60 mm	⊕	31707SB
T8 x 60 mm	⊕	31708SB
T9 x 60 mm	⊕	31709SB
T10 x 80 mm	⊕	31710SB
T15 x 80 mm	⊕	31715SB
T20 x 100 mm	⊕	31720SB
T25 x 100 mm	⊕	31725SB
T27 x 115 mm	⊕	31727SB
T30 x 115 mm	⊕	31730SB

## Workshop screwdriver, T profile without hole



Workshop screwdriver with 2-component handle, black/grey, RX edition, blade made of high-alloy chrome-plated molybdenum-vanadium steel, with burnished tip

- preserved by the twist of the blade and handle connections
- high torque transfer and optimum transmission of torque due to ergonomic handle shape



Profile	Size	Blade Length	Part no.
⊕	T 8	70 mm	31208L
⊕	T 10	80 mm	31210L
⊕	T 15	80 mm	31215L
⊕	T 20	90 mm	31220L
⊕	T 25	90 mm	31225L
⊕	T 27	110 mm	31227L
⊕	T 30	110 mm	31230L
⊕	T 40	120 mm	31240L





## Screwdriver, 5 Star with hole



e.g. for unit pumps on Mercedes-Benz trucks (Actros and Atego), air flow meters on VAG vehicles, spare wheel holders, instrument and interior panelling

Audi  
Mercedes-Benz LKW  
Seat  
Škoda  
VW



Description	Profile	Part no.
IP10 x 125	⊕	31510L-10
IP15 x 125	⊕	31510L-15
IP20 x 125	⊕	31510L-20
IP25 x 125	⊕	31510L-25
IP27 x 125	⊕	31510L-27
IP30 x 125	⊕	31510L-30
IP40 x 125	⊕	31510L-40
IP45 x 125	⊕	31510L-45

## Hose clamp tool, Hexagonal



Flexible, with encapsulated shaft for protection from humidity, dirt and rust.



Profile	Size	Length	Part no.
●	6 mm	260 mm	02076L
●	7 mm	260 mm	02077L
●	8 mm	260 mm	02078L

## Screwdriver set, Impact proofed



- with 2C-handle, blue/black, blade matt chrome-plated made of CV-S2 steel
- impact-resistant, continuous blade, with impact cap
- with 4 mm hexagon socket for increasing torque
- durable through anti-twisting connection of blade and handle
- optimum torque transmission through ergonomic and non-slip handle shape
- with black, magnetic tip

Content:

- Screwdriver slot 4,5 mm, 5,5 mm, 8 mm
- Philips PH1, PH2



Description	Part no.
5-piece, 4,5+5,5+8, PH 1+2	31816L

## Workshop screwdriver set



chrome-vanadium special steel "S2", extremely wear-resistant with through, impact-proof 6-edge blade, hexagon socket drive for increasing torque and magnetised bronzed blades. 2C-handle with finely grooved surface

- plain slot screwdriver 3.2 to 9.5
- cross slot screwdriver PH 0 - 4
- different lengths



Description	Part no.
12-piece	S7891
Empty case	S7891-KOFFER

## Screwdriver impact-proof, Slot



- with 2-component handle, blue/black, continuous impact-resistant blade, with impact cap
- blade matt chrome-plated made of CV-S2 steel, black tip
- with hexagon receiver for torque boost
- durable through anti-twisting connection of blade and handle
- optimum torque transmission through ergonomic and non-slip handle shape



Description	Profile	Part no.
4,5 x 100 mm	⊖	31794SB
5,5 x 125 mm	⊖	31795SB
8,0 x 150 mm	⊖	31798SB

## Workshop screwdriver, Slot

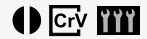

Chrome-vanadium special steel "S2", extremely wear-resistant with through, impact-proof 6-edge blade, hexagon socket drive for increasing torque and magnetised burnished blades. 2-component handle with finely grooved surface



Description	Profile	Part no.
3,2 x 75 mm	⊖	31801SB
5,0 x 75 mm	⊖	31802SB
6,0 x 38 mm	⊖	31803SB
6,0 x 100 mm	⊖	31804SB
8,0 x 150 mm	⊖	31805SB
9,5 x 200 mm	⊖	31806SB

## Screwdriver impact-proof, Cross



- with 2-component handle, blue/black, blade matt chrome-plated made of CV-S2 steel, black tip
- with hole in handle for increasing torque
- durable through anti-twisting connection of blade and handle
- optimum torque transmission through ergonomic and non-slip handle shape



Description	Profile	Part no.
PH1 x 80 mm	⊕	31791SB
PH2 x 100 mm	⊕	31792SB

## Workshop screwdriver, Cross



Chrome-vanadium special steel "S2", extremely wear-resistant with through, impact-proof 6-edge blade, hexagon socket drive for increasing torque and magnetised burnished blades. 2-component handle with finely grooved surface



Description	Profile	Part no.
PH0 x 75 mm	⊕	31901SB
PH1 x 75 mm	⊕	31902SB
PH2 x 38 mm	⊕	31903SB
PH2 x 100 mm	⊕	31904SB
PH3 x 150 mm	⊕	31905SB
PH4 x 200 mm	⊕	31906SB





## Allen key set, Hexagonal socket ball head



Chrome-vanadium, in patented holder, angled fitting up to 15°.



① Holder can be used as T-handle!

Description	Profile	Part no.
8-piece, inner hexagon 2 - 2.5 - 3 - 4 - 5 - 6 - 8 - 10 mm	⊗	04370SB

## Allen key set, T profile without hole



Chrome-vanadium, in patented holder, angled fitting up to 15°.



① Holder can be used as T-handle!

Description	Profile	Part no.
8-piece, T-profile without hole T 10 - 15 - 20 - 25 - 30 - 40 - 45 - 50	⊗	04485SB

## Allen key set, T profile with hole



Chrome-vanadium, in patented holder



① Holder can be used as T-handle!

Description	Profile	Part no.
8-piece, T-profile, tamperproof T 10 - 15 - 20 - 25 - 30 - 40 - 45 - 50	⊗	04484L





## Hand-held impact wrench set



with oversize inner hex bits for worn screws, high-strength version.

The tools are made with a slight oversize and are tapered. This means the bits can be struck into the screw head by means of a hammer and then loosened with a spanner or even better with the hand-held impact wrench included.



① **Ideal for brake discs, brake callipers, starters, belt pulley etc.**

Description	Profile	Size	Part no.
12-piece set			<b>05040L</b>
	⊛	T 40	<b>05233L</b>
Oversize bit 5.1 mm	○	5,1 mm	<b>05035L</b>
Oversize bit 6.1 mm	○	6,1 mm	<b>05036L</b>
Oversize bit 7.1 mm	○	7,1 mm	<b>05037L</b>
Oversize bit 8.1 mm	○	8,1 mm	<b>05038L</b>

## Hammers / Chisels / Punches

### Hammer

high-quality hammer for maximum working safety

- hickory handle, extremely impact-proof
- handle protective sleeve
- safety pin
- round safety wedge
- forged head
- manufactured according to DIN 1041, TÜV-tested



① **Hickory handle and metal shaft protection sleeve**

Head weight	Part no.
200 g	<b>50902L</b>
300 g	<b>50903L</b>
400 g	<b>50904L</b>
500 g	<b>50905L</b>
800 g	<b>50908L</b>
1000 g	<b>50910L</b>
1500 g	<b>50915L</b>
2000 g	<b>50920L</b>

### Club hammer

**DIN**

forged, with wooden handle



Head weight	Part no.
1000 g	<b>50201L</b>
1250 g	<b>50202L</b>
1500 g	<b>50203L</b>
2000 g	<b>50204L</b>



## Sledgehammer

forged, with wooden handle



Head weight	Part no.
3000 g	50600L
4000 g	50601L
5000 g	50602L
6000 g	50603L
8000 g	50604L
10000 g	50605L

## Sledgehammer

with fibreglass handle, the hammer head is wedged and cast, coated matt black, length ca. 900 mm, non-slip rubber handle



Head weight	Part no.
5000 g	50610L

## Non-recoil hammer

without recoil, completely rubberised

- made of polyurethane glass fibre
- the hammer does not recoil thanks to steel balls in the hammer head
- especially for use during tyre changing for loosening rims that have become rusted tight



Head diameter	Length	Weight	Part no.
60 mm	375 mm	1,200 g	51112L

## Non-recoil hammer

non-recoil, completely rubberised

- made of polyurethane glass fibre
- the steel balls in the hammer head prevent the hammer recoiling
- especially for use during tyre changing, for loosening rims that have become rusted tight



Head diameter	Length	Weight	Part no.
70 mm	500 mm	2,1 kg	51113L
105 mm	1050 mm	5,250 kg	51115L

## Body chisel

with hand protection, secured impact head



Length	Width	Part no.
240 mm	26 mm	94000L





## Body slot-type chisel set



- 1 wide body chisel 60 mm wide x 250 mm long, with heavy hand protection
- 1 narrow body chisel 26 mm wide x 230 mm long, with heavy hand protection
- 1 narrow body chisel 26 mm wide x 230 mm long, without hand protection
- 1 special body chisel 20 mm wide x 295 mm long, with extra thin tip, with space-saving light insulation

4-piece

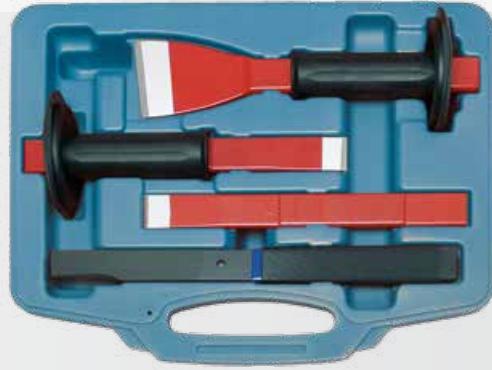

Description

Part no.

4-piece

94005L

## Body separating chisel set



single-piece blade and ergonomic handle. For cutting welding points on bodywork.

- 3 different shapes (straight, 15° angle, 90° angle)

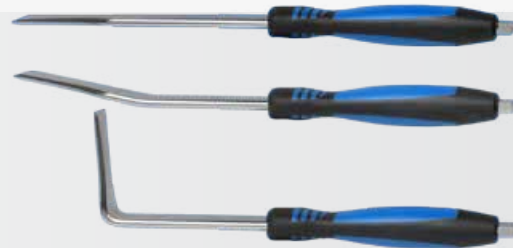

Description

Part no.

3-piece

94006L

Straight

94007L

15° angle

94008L

90° angle

94009L

# Pliers

## Water pump pliers



**Racing Experience**, pushbutton adjustment with fine pitch. Inverted safety box joint with wide guide faces, anti-pinch protection for safe work in any position. High-grade tempering, teeth additionally inductively hardened.

Titanium finish, 2-component handle sleeve



Part no.

41935L

## Power combined pliers



### Racing Experience

- burner hole shaped as multi-purpose ring spanner up to ca. S 18 mm
- titanium finish
- 2-component handle sleeve



Length

Part no.

180 mm

40460L





## Tower pincers

according to DIN ISO 9242A



Length	Part no.
220 mm	40210L
250 mm	40220L

## Pipe wrench



forged, with "S"-jaws, powerful hold and slip-off protection thanks to 3-point grip, painted blue, jaws polished



Description	Length	Part no.
1.0 inch	335 mm	42210L
1.5 inch	420 mm	42220L
2.0 inch	525 mm	42230L

## Bolt cutter

handles made of steel tube, with adjustable blades, with rubber grips



Description	Length	Part no.
Max. 6 mm Ø	465 mm	45050L
Max. 8 mm Ø	620 mm	45060L
Max. 10 mm Ø	750 mm	45070L
Max. 12 mm Ø	920 mm	45080L

## Gripping pliers set

with non-slip handles

- 2 universal-gripping pliers, 130 mm
- 3 universal-gripping pliers, 180 mm
- 5 universal-gripping pliers, 225 mm
- 1 langbeck locking pliers, 160 mm
- 1 langbeck locking pliers, 225 mm
- 2 spot welding locking pliers, 280 mm
- 2 welder's locking pliers, 225 mm



Description	Part no.
16-piece	41560L

## Special grip set

With snap release.

- for welding and clamping work on door openings, wheel arches, side walls, folding plates and also U-profiles etc.
- as mounting aid on doors, wheel arches and many other places



5-piece	Part no.
	41561L

## Automatic gripping pliers

CrMo 

with quick-action adjustment

- can be used without any pre-adjustment
- infinite adjustment of the clamping force independent of the workpiece
- simple and injury-free release
- high-strength version



 **One-handed operation possible!**

Length	Part no.
150 mm	41551L
250 mm	41552L

## Locking pliers

with forged jaws, with wire cutter





Length	Part no.
250 mm	41500L

## Locking pliers, Extra short

mini, universal version, semi-circular jaws, chrome-plated, 6 rivets

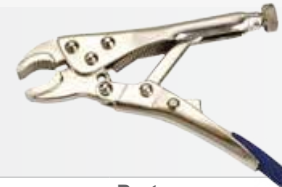



Length	Part no.
100 mm	41501L

## Locking pliers

with forged jaws, with wire cutter, adjustable, lever insulated with vinyl

- clamping range up to 32 mm





Length	Part no.
250 mm	41502L

## Locking pliers

Special steel, 3-fold adjustment, can be clamped up to 55 mm





Length	Part no.
250 mm	41505L

## Langbeck Locking pliers

with extremely narrow bit for spots that are difficult to access





Length	Part no.
170 mm	41520L
225 mm	41521L





## Spot welding locking pliers



forged

side length: 80 mm

max opening width: 80 mm



### Total length

270 mm

460 mm

Part no.

**41515L**

**41516L**

## Shear rivet tool



for aluminium and steel rivets and rivet nuts, with many accessories, an absolute must for working on riveted window lifters

- pads 3.2 - 4.0 - 4.8 - 5.0 - 6.4 mm
- rivet nuts M4 - 5 - 6 - 8 - 10
- handles can be unfolded to 500 mm
- little force required



### Length

500 mm

Part no.

**42760L**

## Stripping pliers



self-adjusting 0.2 - 6 mm<sup>2</sup>, with wire cutter

- ideal for doubly insulated cables
- separates insulation in the middle of a cable too, to solder branches
- for pressing insulated or non-insulated cable lugs and ignition plugs



**Self-adjusting**

### Length

210 mm

Part no.

**42410SB**

## Cable lug gripper



with replaceable jaws, forced lock, 2-component insulated handle, in plastic box

- jaw A: for insulated cable lugs from 0.5 - 6.0 mm<sup>2</sup> (red, blue, yellow)
- jaw B: for closed, non-insulated cable lugs from 0.5 - 10.0 mm
- jaw C: for open, non-insulated cable lugs from 0.5 - 6.0 mm, up to 6.3 mm width
- jaw D: for cable end sleeves with and without collar from 0.5 - 4.0 mm
- jaw F: for cable end sleeves over 4.0 mm



### Description

- 6-piece
- Pair of replacement jaws A
- Pair of replacement jaws B
- Pair of replacement jaws C
- Pair of replacement jaws D
- Pair of replacement jaws F

Part no.

**42585L**

**42585L-A**

**42585L-B**

**42585L-C**

**42585L-D**

**42585L-F**

## Circlip pliers set, Extra long

maxi, for inner and outer circlips, lockable, exchangeable tips

- straight - 45° - 90°
- max. spread 85 mm

① 3 mm tips

Length  
440 mm

Part no.  
41416L



## Circlip pliers

for wheel bearing circlips according to DIN 472 and 984, max tip diameter according to DIN 5256: 2.3 mm, for bore diameters of 40 - 100 mm, anti-slip handle.

The 45° angle of the tips enables precise work. Two available sizes cover all standard ranges of circlips used on wheel bearings.



Description	Length	Part no.
Size 2 / D 40-100 mm	220 mm	41310L
Size 3 / D 85 - 140 mm	330 mm	41315L

## Circlip pliers

according to DIN, forged, chrome-plated

- sturdy shape
- non-slip precision tips
- Titan finish
- insulated handles
- for circlips 19 - 60 mm

① 1,7 mm stips Ø

Description	Head version	Length	Part no.
Outer circlip, straight	Straight	180 mm	41301L
Outer circlip, bent	Bent	170 mm	41302L
Inner circlip, straight	Straight	180 mm	41401L
Inner circlip, bent	Bent	170 mm	41402L



# Air Tools

## Pneumatic impact wrench

12.5 mm (1/2") drive

- high performance twin hammer mechanism
- fatigue-proof work due to extremely low net weight
- single handed switching for clockwise / anticlockwise running
- very low noise
- very low vibration
- threefold torque selection
- with a non-slip handle
- 1/4" inlet nipple included



Maximum	Length	Weight	Part no.
1756 Nm	183 mm	1,9 kg	S3276





## Pneumatic impact wrench



20 mm (3/4") drive

- pistol design
- high performance twin hammer mechanism
- very light aluminium casing
- very low noise
- low-vibration
- threefold torque selection
- with a non-slip handle
- 3/8" inlet nipple included



Maximum	Length	Weight	Part no.
3200 Nm	215 mm	3,40 kg	S3277

## Pneumatic impact wrench



25 mm (1") drive

- pistol design
- high performance twin hammer mechanism
- aluminium casing very low in weight
- very quiet
- low-vibration
- threefold torque selection
- with a non-slip handle
- 3/8" inlet nipple included



Maximum	Length	Weight	Part no.
3200 Nm	223 mm	4,4 kg	S3278

## Light Duty pneumatic impact wrench



25 mm (1") drive

- short anvil
- high performance twin hammer mechanism
- aluminium casing very low in weight
- low-vibration
- threefold torque selection
- 1/2" inlet nipple included



Maximum	Length	Weight	Part no.
3800 Nm	378 mm	6,3 kg	S3279

## Light Duty pneumatic impact wrench



25 mm (1") drive

- long anvil 210 mm (8,3")
- high performance twin hammer mechanism
- aluminium casing very low in weight
- low-vibration
- threefold torque selection
- 1/2" inlet nipple included



Maximum	Length	Weight	Part no.
3800 Nm	547 mm	7,2 kg	S3280



## Mini grease gun including grease bag



SW-Stahl mini grease gun, including a grease tube (80 g) for filling the grease gun.

- ideal tool for regular maintenance on striking mechanism of impact wrenches
- supports the long life cycle of impact wrenches
- easy handling
- suitable for nearly every kind of impact wrench



Description  
2-piece

Part no.  
64311L

## Pneumatic ratchet wrench

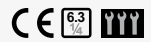

6,40 mm (1/4") drive

- ratchet head protected against dirt
- easy to switch (left / right)
- fatigue-proof work as a result of extremely low net weight
- very quiet
- rear exhaust
- cold insulated and anti-slip handle
- very low-vibration
- 1/4" inlet nipple included



Drive	Maximum	Length	Weight	Part no.
	41 Nm	196 mm	0,5 kg	S3281
	41 Nm	196 mm	0,5 kg	S3282

## Pneumatic ratchet wrench



12.5 mm (1/2") drive

- ratchet head protected against dirt
- easy to switch (left / right)
- fatigue-proof work as a result of extremely low net weight
- very quiet
- rear exhaust
- cold insulated and anti-slip handle
- very low-vibration
- 1/4" inlet nipple included



Drive	Maximum	Length	Weight	Part no.
	68 Nm	256 mm	1,2 kg	S3283

## Pneumatic ratchet wrench

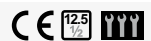

12.5 mm (1/2") drive, with rubberised handle  
incl. 6.3 mm (1/4") pneumatic plug nipple



Drive	Maximum	Length	Weight	Part no.
	108 Nm	286 mm	1,33 kg	S3228





## Blow-out gun for compressed air



made of seamless, chrome-plated steel tube, handle made of blue nylon fibre, (1/4") inner thread



### Length

1000 mm  
325 mm  
250 mm  
100 mm

### Part no.

21514L  
21516L  
21517L  
21518L

## Vibro pneumatic chisel set



contains 4 different impact chisels with different Profiles. ideal for support e.g.:

- when loosening nuts and screw connections which have rusted tight
- for pressing the supporting joint cone out of the rear axle
- with rust solvents, since they penetrate deeper due to the vibration
- incl. compressed air nipple 1/4"
- with quick-action chuck
- with backlash damping
- stroke rate: 2100/min.
- chisel shaft: around 10 mm
- working stroke: 10 mm
- working pressure: 6.2 bar



### Description

8-piece

### Blow count

2100/min

### Working pressure

6,2 bar

### Part no.

S3211

## Needle scaler attachment

The needle scaler attachment is used for the removal of coatings on solid metal parts. With the metal needles it is the perfect tool to get rust off rims, frame parts or iron fences. Additionally you easily are able to remove paint, plastering or cement.

The needle scaler is an attachment to pneumatic chippings from sets S3211 and S3213.

Main features:

- 19 needles with diameter 2,8 mm each
- diameter of inner stud 10,1 mm
- diameter of support of thread ~ 30,5 mm



### Part no.

S3215

## Pneumatic air underbody protection gun



suitable for all standard cartridges, with cavity hose 500 mm



⚠ Clean thoroughly after each use!

### Air consumption

300 l/min

### Max. operating pressure

8 bar

### Part no.

25050L

## Pneumatic grease gun

volume 400 ccm, complete with

- nozzle pipe
- hydraulic mouthpiece
- reinforced hose

① suitable for cartridges

Working pressure min/max

max. 8 bar



Part no.

**64350L**

## Pneumatic tyre filler

calibrated version according to standard 86/217/EWG

- rubber-sheathed gauge
- with flexible 400 mm hose
- measuring / filling range 0 - 10 bar

Product property

Calibrated

Max. operating pressure

10 bar

Part no.

**25032L**



## Pneumatic tyre filler

European make, calibrated version according to standard 86/217/EWG

- measuring / filling range 0 - 10 bar
- gauge rubber-sheathed
- length of filling hose ca. 540 mm
- scale diameter 56 mm (visible)

Product property

Calibrated

Max. operating pressure

10 bar

Part no.

**25034L**



## Spare hose

tyre air pistol, suitable for 25030L, 25032L, 25034L



Description

reinforced version

Length

430 mm

Part no.

**25036L**

reinforced version

530 mm

**25037L**

standard version

1000 mm

**25038L**

## Pneumatic air hose

(transparent) with fabric lining, coupling and plug nipple  
(DN 7.2 brass) prefitted

- Maximum operating pressure: 10 bar
- Fabric lining: Polyester threads
- Operating temperature: -20°C to +60°C
- Without cadmium or silicon
- Age and UV-resistant

Inner diameter

13 mm

Length

10 m

Part no.

**25095L**





## Torque Wrench



- calibrated torque with certificate and serial number
- accuracy  $\pm 4\%$
- with switchable ratchet head
- direct numerical display of the desired torque values
- extra fine scale division
- reliable locking of the rotary handle by means of push button
- ergonomically optimized handle
- service-friendly as repair kits are available



Description	Drive	min. Torque	max. Torque	Part no.
		20 Nm	100 Nm	<b>03813L</b>
		40 Nm	200 Nm	<b>03814L</b>
		60 Nm	340 Nm	<b>03815L</b>
Repair set				<b>03813L-REP</b>
Repair set				<b>03814L-REP</b>
Repair set				<b>03815L-REP</b>
Spare handle				<b>03819L</b>



## Torque Wrench



- calibrated torque with certificate and serial number with switchable ratchet head
- accuracy  $\pm 4\%$
- direct numerical display of the desired torque values
- reliable locking of the rotary handle by means of push button
- extra fine scale division
- ergonomically optimized handle
- service-friendly as repair kits are available



Description	Drive	min. Torque	max. Torque	Part no.
		110 Nm	550 Nm	<b>03816L</b>
		150 Nm	750 Nm	<b>03817L</b>
Repair set				<b>03816L-REP</b>
Spare handle				<b>03819L</b>



## Torque Wrench



- calibrated torque with certificate and serial number with switchable ratchet head
- accuracy  $\pm 4\%$
- direct numerical display of the desired torque values
- reliable locking of the rotary handle by means of push button
- extra fine scale division
- ergonomically optimized handle
- service-friendly as repair kits are available



Description	Drive	min. Torque	max. Torque	Part no.
		200 Nm	1000 Nm	<b>03818L</b>
Repair set				<b>03818L-REP</b>
Spare handle				<b>03819L</b>

## Torque Wrench



- calibrated torque wrench with certificate and serial number
- left and right-handed
- with switchable ratchet head
- double scale Ft-LB / Nm
- extra-fine scale division
- secure locking of the rotary handle
- service-friendly as repair kits are available



Drive	min. Torque	max. Torque	Part no.
	20 Nm	100 Nm	<b>03808L</b>
	40 Nm	200 Nm	<b>03807L</b>
	60 Nm	340 Nm	<b>03821L</b>

## Torque wrench



- calibrated torque wrench with certificate and serial number
- for clockwise and anti-clockwise tightening
- with changeable ratchet head
- double scale Ft-LB / Nm
- extra-fine dial division
- secure interlocking of the turn grip
- service friendly, since repair sets are available



Drive	min. Torque	max. Torque	Part no.
	110 Nm	550 Nm	<b>03822L</b>

## Torque wrench



- Socket connector for insert tools, 14x18 mm
- The head is replaced in seconds
- Calibrated torque wrench with calibration certificate and series number
- Direct numerical display of the selected torque value
- Secure locking of the rotating handle by push button
- Ideal ergonomic handle form
- Repair set is available as a welcome service feature
- Wide programme of optionally available insert tools



min. Torque	max. Torque	Part no.
40 Nm	200 Nm	<b>03830L</b>

## Reversible ratchet insert

with square insert 14 x 18 mm



Drive	Part no.
	<b>03831L</b>

## Square drive insert

with square insert 14 x 18 mm



Drive	Part no.
	<b>03832L</b>





## Open-ended spanner insert

with 14 x 18 mm support.



Description	Part no.
Open-ended spanner insert size 13	03833L
Open-ended spanner insert size 14	03834L
Open-ended spanner insert size 15	03835L
Open-ended spanner insert size 16	03836L
Open-ended spanner insert size 17	03837L
Open-ended spanner insert size 18	03838L
Open-ended spanner insert size 19	03839L
Open-ended spanner insert size 21	03841L
Open-ended spanner insert size 22	03842L
Open-ended spanner insert size 24	03844L
Open-ended spanner insert size 27	03847L

## Ring wrench insert

with 14 x 18 mm support.



Description	Part no.
Ring-spanner insert size 13	03853L
Ring-spanner insert size 14	03854L
Ring-spanner insert size 15	03855L
Ring-spanner insert size 16	03856L
Ring-spanner insert size 17	03857L
Ring-spanner insert size 18	03858L
Ring-spanner insert size 19	03859L
Ring-spanner insert size 21	03861L
Ring-spanner insert size 22	03862L
Ring-spanner insert size 24	03864L
Ring-spanner insert size 27	03867L

## Torque wrench

switchable, set value can be locked



Description	Drive	min. Torque	max. Torque	Part no.
		100 Nm	500 Nm	03940L-IMP
		140 Nm	700 Nm	03941L-IMP
		140 Nm	980 Nm	03942L-IMP
Repair set 3/4"				03942L-REP

## Rotary angle measuring device

for use on 12.5 mm (1/2") drive tools with maximum measuring precision, enables tightening of the specified angle e.g. for cheese-head screws in one operation,



- max. load capacity approx. 280 Nm
- full-metal version with magnetic foot for fixing

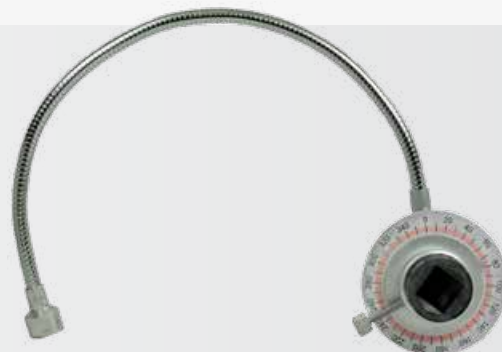

Drive	Part no.
	03916L

## Torque reproducer

DBGM    

truck wheel bolt service set with integrated torque wrench. Facilitates the loosening of wheel bolts with up to 1.400 Nm as well as the tightening with up to 650 Nm. Therefore it is an ideal tool for service operations.

As a counter-piece is included, the torque reproducer is also suitable for installation and removal of wheel bolts on wheels with wheel cap. Please be advised that you need to order suitable impact spanner sockets separately.



① Please check the tightening torque immediately after wheel change!

Description	Drive	Part no.
4-piece		03955L



## Torque reproducer

Reproducer and truck wheel bolt service set, 25 mm (1") input and output with extension, crank and inserts 24, 27, 30, 32, 33, 36, 38 mm, transferrable torque: 3200 Nm.

CAUTION: Only use for loosening purposes. The extreme 56-fold gear ratio will otherwise lead to damage to screws, threads and nuts. Even extremely tight or rusty wheel bolts can be loosened easily, then the bolt is either removed quickly or refitted using the extension and crank.



Description	Drive	Part no.
10-piece, 24, 27, 30, 32, 33, 36, 38 mm		03965L
5-piece, 32, 33 mm		03966L

## Engine

### Oil filter bell set

for commercial vehicles

- sizes 36 mm, hexagon Mercedes-Benz (e.g. Axor BR 400, Atego BR 900, Actros BR 500, buses), Scania (PDE V8 engine, HP1 engine fuel filter), various oil and fuel filter housing covers
- size 74 mm, 14-edge DaiMAN (series TGM and TGL), Mercedes-Benz (e.g. Sprinter engine series 600), VW e.g. Transporter), universal use on passenger cars too, oil filter housing cover and oil filter
- size 66/67 mm, 14-edge Daihatsu, Toyota
- size 106 mm, 15-edge MAN (8-10 tonnes series L 2000), Scania (PDE engine), Fiat (Ducato 2.5 D/TD), Iveco oil filter and fuel filter (for MAN filter Nr. W 1160)
- size 07 mm, 15-edge Volvo, Iveco, Renault, Scania oil filter and fuel filter
- size 108 mm, 15-edge Volvo, Iveco, Renault, Scania oil filter and fuel filter
- size 108 mm, 18-edge Renault Transporter (Master, Traffic 2.4l, 2.5l, 2.8l D/TD) Opel (Movano)
- Gr. 135 mm, 18-edge MAN 18-48 tonnes series F 2000, TGA, oil filter housing cover (406, 410, 414, 440, 460)



Renault LKW  
Scania LKW  
Mercedes-Benz LKW  
MAN LKW  
Fiat LKW  
Iveco LKW  
Toyota LKW  
Volvo LKW

Description	Part no.
9-piece	08465L
Size 74 mm, 1 square with 10 mm (3/8") / 21 mm hex drive	08465L-74
Size 107 mm, 15-edge with 10 mm (3/8") / 21 mm hex drive	08465L-107
Size 135 mm, 1 octagon with 10 mm (3/8") / 21 mm hex drive	08465L-135



## Oil filter pliers



3-stage oil filter pliers that require little room in the engine compartment.

Even oil filters that are difficult to reach and extremely tight are easy to loosen with this tool, making work much easier.

- suitable for passenger cars, light trucks, tractors
- no slipping off during filter change
- extra strong design with non-slip coating
- forged version



Description	Length	Part no.
Clamping width 60 - 90 mm	250 mm	<b>08435L</b>
Clamping width 80 - 120 mm	400 mm	<b>08438L</b>

## Heavy duty filter loosening key



For air dryer cartridges and oil filters, right and left operation, therefore suitable for loosening and tightening.

- diameter of ca. 104 - 165 mm
- length of gripping arms 60 mm
- 12,5 mm (1/2") drive
- extra heavy version 1366 g



ⓘ **Right and left operation!**

Size	Part no.
155 mm	<b>08405L</b>

## Injection nozzle extractor



for easy and professional dismantling of the nozzles on MAN and Mercedes-Benz trucks

**MAN LKW  
Mercedes-Benz LKW**

- Carbon steel extractor with 4-tooth foot and 27 mm hex to apply counterpressure
- M14 extracting spindle
- Extracting spindle with 6 mm internal hex to dismantle the nozzle on spindles



Length	Part no.
105 mm	<b>26014L</b>

## Pin and groove nut set



for the pressure screws on the nozzle holder

**Mercedes-Benz LKW  
MAN LKW**

- 1 socket 12.5 mm (1/2") drive, 4-tooth, 72 mm long (for Mercedes-Benz series OM 401/421, 403/423, LA, A, 470)
- 1 socket with 32 mm outer hexagon drive, 4-tooth with inner thread M14x 1.5 mm, 70 mm long (for Mercedes, Neoplan, Setra)
- 1 socket 12.5 mm (1/2") drive, 3-tooth, 120 mm long (for Mercedes, MAN)
- 1 socket with 32 mm outer hexagon drive, 4-tooth, 120 mm long (for Mercedes-Benz, MAN)

ⓘ **OM401, OM402, OM403, OM404, OM407, OM409, OM421, OM422, OM423, OM424, OM441, OM442, OM443, OM444, OM427, OM429, OM447**



Description	Part no.
4-piece	<b>10325L</b>



## Radiator removal tool case

Complete with pump and seven radiator adapters for common trucks from DAF, IVECO, Mercedes-Benz, MAN, Scania, Renault and Volvo.

- measuring range 0 - 2.5 bar
- check on pressure loss through manometer
- possibility of testing locking caps
- pressure test on the cooling system



MAN LKW  
Iveco LKW  
DAF  
Mercedes-Benz LKW  
Renault LKW  
Scania LKW  
Volvo LKW



Description	Part no.
8-piece	21040L
Pump without hose	21002L
Hose	21003L
Adapter SCANIA-113, -114, -124 and -125	21042L
Adapter DAF-XF 95, XF 105	21043L
Adapter 40-150, MB-Actros, -Atego, Axor, -ECO 8401, LKW 1728, MAN-F 90, -F 2000, IVECO-EURO-Star, EURO-Tech, Euro-Truck, Strahlis	21044L
Adapter IVECO-Daily 2000 C series, RENAULT-Magnum	21045L
Adapter MAN L2000	21046L
Adapter Volvo FH 12	21047L
Adapter MB Sprinter to 06, Vito	21048L

## Band-type clamp pliers

for self-clamping spring clamps from 18 – 54 mm on fuel and coolant hoses.

- with bowden cable, suitable for all installation spots which are difficult to access
- safe hold thanks to lever locking

e.g. for:

- Alfa, Audi, Citroën, Fiat, Ford, Hyundai, Lancia, MAN, Mercedes-Benz, Mini (BMW), Opel, Peugeot, Porsche, Renault, Seat, Toyota, VW, Volvo, etc.



Alfa Romeo  
Audi  
Citroën  
Fiat  
Ford  
Hyundai  
Lancia  
MAN  
Mercedes-Benz  
Mini  
Opel  
Peugeot  
Porsche  
Renault  
Seat  
Toyota  
Volvo  
VW

Description	Length	Part no.
Band-type clamp pliers with bowdencable	630 mm	61777L
Replacement bowdencable	630 mm	61777L-1

## Engine bridge

to support the engine when removing the gearbox. Suitable for

- VW T5

Used equivalent to:

- VW OE no. 10-222A/23 support arms

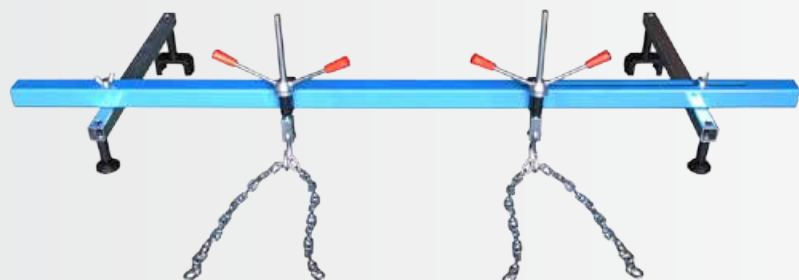

VW

Part no.
20304L



## Engine support bar

for pulling the engine and gearbox when exchanging the coupling or gearbox.

Suitable for:

- VW T4 (4 and 5 cylinder models)

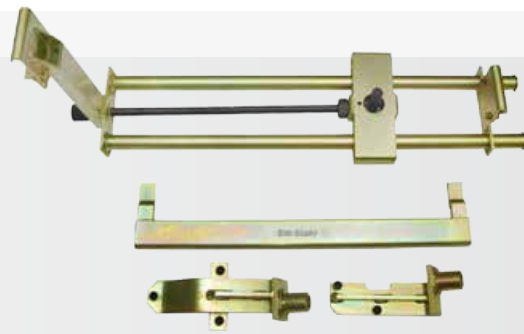

VW

Part no.  
**20308L**

## IMPACT special spanner socket, Spline

for flywheel screws e.g. Mercedes-Benz Atego



Mercedes-Benz LKW



Profile	D	Length	Part no.
○	M 16	80 mm	<b>410120L</b>

## Engine adjustment tool set

e.g. for the following work:

- testing and for setting the timing
- for replacing the timing chain
- replacing the cylinder head gasket

VW Touareg, Phaeton, Transporter (T5) from model year '03-'09 with 5 and 10 cylinder diesel engine 2,5 TDI pump-injector motorcode: BAC, BLK, BPD, AXD, AXE, BLJ, BNZ, BPC and 4,9 D/TDI pump-injector-motorcode: AYH, BKW, BLE, BWF

- camshaft clamping tool VW OE-No. T10193 and T10194
- crankshaft clamping tool for VW 10 cylinder OE-No. T10195
- clamping device VW OE-No. T10199 and T10199/1
- guide pin for gear case VW OE-No. T10200
- wrench for crankshaft VW OE-No. T10225
- crankshaft clamping tool for VW 5 cylinder OE-No. T10226
- installation tool VW OE-No. T10234



VW

Description	Part no.
13-piece	<b>26008L</b>

## Engine adjustment tool set

for Renault and different Volvo and Opel petrol and diesel engines, contains important tools e.g. for the following work:

- Locking the flywheel, crankshaft and injection pump shaft
- Pulling off the crankshaft belt pulley
- Tensioning the toothed belt
- Positioning the camshaft and pump shaft to the crankshaft

ⓘ **The camshaft and crankshaft adjustment tools are not to be used as counter hold tools!**



Renault  
Volvo  
Opel

Description	Engine type	Part no.
Renault	Universal	<b>26058L</b>

## Compression and pressure loss tester

for petrol & diesel engines.

For professionally testing compression and pressure loss in most car, truck, motor cycle, bus, agricultural vehicle and boat engines as well as in Hdi / TDCi and pump nozzle engines.

Contains a glow plug adapter for the following manufacturers e.g.: Alfa, BMW, Chrysler, Daewoo, Fiat, Ford, Hyundai, Isuzu, Land Rover, Mazda, Mercedes-Benz, Mitsubishi, Nissan, Opel, PSA, Renault, Saab, Suzuki, Toyota, VAG, Vauxhall, Volvo, etc.

- glow plug adapters M10, M12, M14 and M18
- compression pressure tester, max. 50 bar
- quick-action couplings (straight and angular versions)
- injection nozzle adapters M20, M22, M24 and for Ford Stanadyne injectors



- Alfa Romeo
- BMW
- Chrysler
- Daewoo
- Fiat
- Ford
- Hyundai
- Isuzu
- Land Rover
- Mazda
- Mercedes-Benz
- Mitsubishi
- Nissan
- Opel
- Renault
- Saab
- Suzuki
- Toyota
- Vauxhall
- Volvo



Description	Engine type	Part no.
48-piece	Petrol / Diesel	26119L

## Wheel and Brake

### Wheel nut wrench

based on DIN 899

- extremely stable design made from high-quality chrome vanadium
- with 22 mm turning pin (length 600 mm)
- matt chrome plated
- in practical fabric bag



Description	Size 1	Size 2	Part no.
	24 mm	27 mm	02245L
	27 mm	32 mm	02247L
	30 mm	32 mm	02251L
Cross bar			02242L

### Wheel nut wrench

based on DIN 899

- extremely stable design made of high-quality chrome vanadium steel
- mat chrome-plated



Size 1	Size 2	Length	Part no.
24 mm	27 mm	400 mm	02220L
27 mm	32 mm	400 mm	02222L
30 mm	32 mm	400 mm	02226L

### Spider wrench

Industrial version, forged, hardened, 340 mm arm length



#### Trucks

Description	Size 1	Size 2	Size 3	Size 4	Length	Part no.
24 - 27 - 32 mm	24 mm	27 mm	32 mm	3/4"	660 mm	02400L



## LCV wheel nut wrench



- with reinforced central plate
- leg length 350 mm



① For trucks!

Size 1	Size 2	Size 3	Size 4	Length	Part no.
24 mm	27 mm	32 mm	3/4"	700 mm	02450L

## IMPACT spanner socket, Hexagonal, Long



Suitable for use with impact wrench, with groove and bore hole for ball, chrome-molybdenum  
Suitable for Scania and Volvo utility vehicles.



Scania LKW  
Volvo LKW

Size 1	Length	Part no.
33 mm	90 mm	07861L

## Truck wheel transporting device



facilitates the transport of truck wheels.

- Max. wheel weight 68 kg



Part no.  
20735L

## Tread depth gauge



for precise determination of the tread depth for trucks, passenger cars and motorbikes.

- sturdy brass version
- 50 mm measuring depth
- scale marking 1/10 mm
- made in Germany



Part no.  
72311L





## Tyre iron



- special shape
- chrome-vanadium
- heavy-duty version for commercial vehicles agricultural and construction machinery
- length 650 mm



Length

650 mm

Part no.

02161L

## Tyre iron



- special shape
- chrome-vanadium
- heavy-duty version for commercial vehicles agricultural and construction machinery
- length 1000 mm



① Suitable only for wheel service – not to be used as chisel!

Length

1000 mm

Part no.

02163L

## Pneumatic tyre filler



European make, calibrated version, according to standard 86/217/EWG.

- measuring / filling range 0 - 10 bar
- gauge rubber-sheathed
- length of filling hose ca. 540 mm
- scale diameter 56 mm (visible)



Product property

Calibrated

Max. operating pressure

10 bar

Part no.

25034L

## Non-recoil hammer



without recoil, completely rubberised

- made of polyurethane glass fibre
- the hammer does not recoil thanks to steel balls in the hammer head
- especially for use during tyre changing for loosening rims that have become rusted tight



Head diameter

60 mm

Length

375 mm

Weight

1,200 kg

Part no.

51112L

## Non-recoil hammer



non-recoil, completely rubberised

- made of polyurethane glass fibre
- the steel balls in the hammer head prevent the hammer recoiling
- especially for use during tyre changing, for loosening rims that have become rusted tight
- for striking bearings, bushings etc. into place



Head diameter

105 mm

Length

1050 mm

Weight

5,250 kg

Part no.

51115L

## Universal brake piston press tool

for brake pistons without rotating device

- printing plates 110 x 60 mm



BMW  
Mercedes-Benz  
Porsche  
Land Rover  
Toyota



### Description

clamping width 96 mm, for large utility vehicles:  
Mercedes-Benz S Class, BMW 7 series,  
Porsche, lightweight vehicles, off-road vehicles

### Part no.

01434L

## Brake piston rewinding tool



for WABCO and Knorr disc brakes on truck axles from  
SAF and other manufacturers under cramped conditions.  
Time saved per wheel is around 15 minutes.



### Description

Special magnetic socket 8 + 10 mm + special spanner  
Magnetic socket 8 mm with 12 mm hexagon drive  
Magnetic socket 10 mm with 12 mm hexagon drive

### Part no.

37500L

37000L-8

37000L-10

## Special socket, Square



for SAF and Knorr callipers



### Description

8 mm square socket

### Part no.

37001L

## Special socket, Spline



for SAF and Knorr callipers



### Description

XZN tripe square M9 and hexagon 12 mm

### Part no.

37002L

## Flexible magnetic base holder



flexible, for gauge or other measuring instruments

- Thanks to the prism base which can be switched on and off, the bracket holds perfectly to struts, which are not made of alloy material
- For versatile adjustment including precision setting
- Ideal for testing the brake discs and wheel hubs for axial run-out



ⓘ Can be used with 26067L precision gauge!

### Description

Holder

Gauge

### Part no.

07354L

26067L



## IMPACT socket, E Profile



for fitting wheel flange screws M18 x 1.5 as well as for changing brake discs on trucks



① M2000, D08

Description	Profile	Size	Length	Part no.
for fitting wheel flange screws M18 x 1.5 as well as for changing brake discs on trucks	★	24 mm	110 mm	38000L
for cylinder head screws MAN, new TGA engines	★	22 mm	110 mm	38001L
for cylinder head screws MAN M2000, buses with engine types D08	★	18 mm	110 mm	38003L

## IMPACT socket



Special sockets for T-profile screws, suitable for use with impact wrench, 20 mm (3/4") drive, especially for steering column stalks and brake callipers for the Mercedes-Benz Actros

Mercedes-Benz LKW

High-strength version for extreme loads



Size	Length	Part no.
T60	130 mm	05370L
T60	80 mm	05390L

## IMPACT socket, Double hexagon



for brake discs on SAF axles



Profile	Size	Part no.
●	13 mm	01444L

## IMPACT brake calliper socket, Hexagonal socket



in special length for mounting the brake calliper screws on the rear axle of Mercedes-Benz Actros and Citaro models with axle types HL7 + HL8 Hypoid, Neoplan ZF as well as MAN TGA wheel hubs

Mercedes-Benz LKW  
MAN LKW



Profile	Size	Length	Part no.
○	14 mm	138 mm	01441L

## Brake calliper spanner, Double hexagon



for mounting the attachment screws on the front braking system of Mercedes-Benz Atego and Actros vehicles

Mercedes-Benz LKW



Profile	Size	Part no.
●	24 mm	01437L



## Brake linkage slack adjuster pull-off tool, Hexagonal



for automatic linkage slack adjusters. Very sturdy welded design made of tempered hardened steel for pulling off stiff brake linkage set slack adjusters. Applications for truck trailers and semi-trailers. Thanks to the ring-shaped contact surface, the tool is suitable for both older and automatic brake linkage slack adjusters.

Excess load and injuries are excluded to a major extent through the safety shearing bushing. Reduces the risk of accident and goes easy on the material. Spindle and shearing bushing are available as spare parts.

- Drive size 32 hexagon
- coated in gold colour



Description	Profile	Size	Part no.
for Haldex system	●	32 mm	01442L

## Brake linkage slack adjuster pull-off tool, Hexagonal



for automatic linkage slack adjusters. Very sturdy welded design made of tempered hardened steel for pulling off stiff brake linkage set slack adjusters. Applications for truck trailers and semi-trailers. Thanks to the ring-shaped contact surface, the tool is suitable for both older and automatic brake linkage slack adjusters. Excess load and injuries are excluded to a major extent through the safety shearing bushing. Reduces the risk of accident and goes easy on the material. Spindle and shearing bushing are available as spare parts.

- Size 32 hexagon drive
- coated silver coloured



Description	Profile	Size	Part no.
for BPW system	●	32 mm	01443L

# Steering / Suspension

## Axle oil pan for trucks



thanks to its special shape, the pan fits in almost every wheel on the drive axle. Ideal for collecting oil during the removal of drive axle shafts on trucks and larger vans. Clean work is improved by two handles at the edge and the spout.

Temperature-resistant from -40° to +80°C



Description	Part no.
Collecting volume 2.5l	10039L

## Hub cap / axle nut wrench



for professional repairs on commercial vehicles.

- Special insert with drive size 41
- 45 mm working depth



① Suitable for axle nuts and dust cover!

Description	Drive	Part no.
111 mm octagonal (BPW rear axle 12t)		10065L
80 mm octagonal (SCANIA front axle)	20	10068L





## Hub cap / axle nut wrench, Octagonal

for professional repairs on commercial vehicles.



Volvo LKW

- Special insert with 20 mm (3/4") internal square socket



① Suitable for axle nuts and dust caps!

Description	Part no.
115 mm octagonal (Volvo)	10071L
100 mm octagonal (Scania rear axle)	10072L

## Axle nut wrench, Hexagonal



e.g. for SAF trailer axle, to prevent slipping off through the special design with guide collar, in order to pick up the flat axle nut safely.

Drive is possible through the size 36 hexagon by means of impact wrench, ratchet, torque wrench etc.

The extremely sturdy version has been milled and turned out of solid material.

- key size: 85.00 mm hexagon
- drive size 36 mm - hexagon
- design height 82.00 mm
- outer Ø 118 mm



Part no.  
10333L

## Axle nut wrench, Hexagonal



with guide collar.

Mercedes-Benz LKW

For Mercedes-Benz Discos Trailer from model year 5/00 with compact bearing HUB-Unit. This axle nut key is suitable to prevent slipping off through the special design with guide collar, in order to pick up the flat axle nut safely. Drive is possible through the size 36 hexagon by means of impact wrench, ratchet, torque wrench etc.

The extremely sturdy version has been milled and turned out of solid material.

- key size: 95 mm hexagon
- drive size 36 mm - hexagon
- design height 157 mm
- inner height 100 mm
- outer Ø 118 mm with collar



Part no.  
10311L

## Axle nut wrench, Hexagonal



for Iveco-Euro-Cargo.

Iveco LKW

This axle nut key is very suitable for preventing slipping off through the special design, in order to pick up the flat axle nut safely. Drive is possible through the size 36 hexagon by means of impact wrench, ratchet, torque wrench etc.

The extremely sturdy version has been milled and turned out of solid material.

- key size: 98 mm hexagon
- drive: size 36 hexagon
- design height: 115 mm
- outer Ø 122 mm



Part no.  
10312L

## Axle nut wrench, Double hexagon



Iveco LKW

with guide collar for Iveco Eurotech-Cursor rear axle.

This axle nut key is suitable to prevent slipping off through the special design with guide collar, in order to pick up the flat axle nut safely. Drive is possible through the size 36 hexagon by means of impact wrench, ratchet, torque wrench etc.

The extremely sturdy version has been milled and turned out of solid material.

- key size: 110 mm double hexagon
- drive size 36 mm - hexagon
- design height 116 mm
- outer Ø 133 mm with collar



Part no.  
10313L

## Groove nut wrench

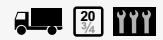

MAN LKW  
Mercedes-Benz

for 10 and 13 t. AP axles without guide tube.

The extremely sturdy version has been milled and turned out of solid material. Designed for high tightening and loosening torques, guide tube replaceable.

- no. of pins: 6
- width of pins: 11.5 mm
- inner Ø pin: 101.0 mm
- inner Ø key: 95.3 mm
- outer Ø key: 115.0 mm
- height with guide tube: 165.0 mm
- height without guide tube: 110.0 mm
- drive 20 mm (3/4") inner square (guide tube 10314L Ø 51.8 mm / guide tube Ø 66.5 mm / 10315L / 10316L)

Application e.g. MAN and MB 10 and 13 t outer planetary axle / Hypoid and trailing axle NR 7/4 (without guide tube) bus 0305G, 0405G



Part no.  
10318L

ⓘ Please order guide tubes 10314L, 10315L or 10316L separately!

## Guide tube



With insertion system and fixing screw for universal use with different groove nut keys. The individual guide tubes only have to be purchased once. The use of the guide tubes guarantees an optimum fit of the groove nut key and a sturdy working position. This practically completely prevents groove nut keys slipping off.

Reduces the risk of accident and goes easy on the material. Guide tubes are replaced or inserted by loosening or tightening the inner hex grub screw (size 3).

Applications: 10+13 t. AP e.g. AP-HA F-series H7, HD7 and AP VA F-series



Description	Part no.
Guide tube with Ø 51,8/46,0 mm x 140 mm length (10+13t AP e.g. AP-HA F series H7, HD7 and AP VA F series)	10314L
Guide tube with Ø 60,0 mm	10315L
Guide tube with Ø 66,5/60,0 mm - 140 mm length (e.g. H7, whole VA F series, Hypoid HA, F series HY-1175, HDY-13110, HY-1180)	10316L



## Clamping nut wrench



Socket spanner for the professional loosening and tightening of square clamping nuts on axle legs. Cast version with milled-out profile and drive square

MAN LKW  
Mercedes-Benz LKW  
DAF

Applications e.g.:

DAF, MB, Kässbohrer-Setra, MAN MB truck axle: VL 3/8, 13, VO 3/10, VL 4/7, 9, 10 VD 4/14, VO 4/11, 13, 18, VL 4/15, 16, 19, VD 4/20 in types: 363, 385, 387, 389, 391, 393, 395, 617, 620, 621, 622, 623, 625, 649.

MB bus axles: VO 3/10, 4/11-13-19 in types: 0303, 0305-G and 0307.

MAN axles Kässbohrer/Setra-axles: Front axle 6.5 + 7.5 t: S210-215, SG 219-221. Tractor axle S 216 HDS, S228 DT

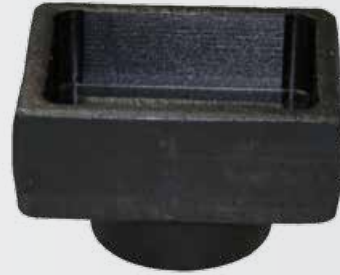

**Description**  
Size 56 x 71 x 3/4"

**Part no.**  
10326L

## Clamping nut wrench



Socket spanner for the professional loosening and tightening of square clamping nuts on axle legs. Cast version with milled-out profile and drive square.

Mercedes-Benz LKW  
MAN LKW

Application: Mercedes-Benz and MAN, for reinforced 9 t front axle VL5 DC trailer axle Discos Trailer from model year 97-5.2000 with compact bearing (HUB-Unit). Identical with the non-driven Actros front axle.



**Description**  
Size 60 x 76 x 3/4"

**Part no.**  
10327L

## Axle wrench



Required for repair work / visual inspection of the brake and replacement of the wheel bearing set. Sturdy - cast version for especially high tightening torques. Size 140 mm.

With following drives:

- size 32 hexagon for pre-tightening 150 Nm
- size 46 hexagon for rotary angle 20-30 degrees

Applications e.g.:

- SAF EURO axles 9 t. (RSM 9042 SK RS/RZ 9042 - 11242 - 9037 - 11037)

Tighten axle nut Euro-axle type SK RS 9042

- in direction of travel to the left - left-hand thread
- in the direction of the travel to the right - right-hand thread

Marking of the axle nut with left-hand thread on the outside of the hexagon with milled-in groove.



**Description**  
Size 140, hexagon drive

**Size**  
32 mm

**Size**  
46 mm

**Part no.**  
10328L

## Groove nut wrench



for Mercedes-Benz Actros

Mercedes-Benz LKW

- no. of pins: 6
- pin width 10 mm
- inner Ø pin: 115 mm
- inner Ø key 105 mm
- outer Ø key 125 mm
- key height: 182 mm

Application e.g.:

Mercedes-Benz Actros rear axle HL/HL 8 (Hypoid axle) - long-distance vehicles



**Part no.**  
10329L

## Groove nut wrench

for MAN TGA inc. guide tube Ø 66.5 mm.

The extremely sturdy version was milled and turned out of solid material. Designed for high tightening and loosening torques, guide tube replaceable.

- no. of pins: 6 (inside)
- pin width: 11.5 mm
- inner Ø pin: 117.0 mm
- inner Ø key: 133.0 mm
- outer Ø key: 148.00 mm
- height with guide tube: 158.0 mm
- Hheight without guide tube: 110.0 mm
- drive 20 mm (3/4") inner square + size 60 outer hexagon

Application e.g. MAN-TGA rear axle.



MAN LKW



Part no.  
10331L

## Groove nut wrench

Groove nut key with fixed guide tube Ø 49.0 mm.

The extremely sturdy version has been designed for high tightening and loosening torques. The guide tube is firmly inserted and inc. sleeve guide tube to Ø 57.0 mm extendable as bayonet lock and with clamping pin.

- no. of pins: 6
- width of pins: 10 mm
- inner Ø pin: 87 mm
- inner Ø key: 80 mm
- outer Ø key: 95 mm
- height: 185 mm
- drive 20 mm (3/4") inner square

Application e.g.: Mercedes-Benz Atego rear axle pinion drive) HL2, Vitaro 814, MAN lightweight class.



MAN LKW  
Mercedes-Benz LKW



Part no.  
10332L

## Leaf spring wrench

for professional reparation of commercial vehicles.

- special bit, 20 mm (3/4") inner hex

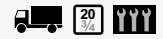

Scania LKW



**Description**  
34 mm, 2-edged  
(Scania rear axle)

Part no.  
10307L

## IMPACT spanner socket, Octagonal

for the front-axle nut in front of the brake disc e.g. on vehicles of the series Scania 124 I, 144 I, series 4 from year '96 for vehicles from 16 tons and others

80 mm octagon x ca. 30 mm working depth  
20 mm (3/4") drive



Scania LKW



Size  
80 mm

Part no.  
10321L





## IMPACT spanner socket, Hexagonal



1" drive, e.g for bolting kingpins



Description	Profile	Size	Part no.
	●	85 mm	10322L
	●	95 mm	10323L
DAF rear axle brake	●	105 mm	10324L

## IMPACT pin wrench



for MAN front axles V9-82L-01 (brake disc version with ABS).

MAN LKW

6 interior pins, 8 mm wide with overall inner diameter 100.5 mm  
20 mm (3/4") drive / 60 mm outer hexagon.



Size	Part no.
100,5 mm	10320L

## IMPACT screwdriver bit, Hexagonal socket, Extra long



special length, for mounting retaining screws on the upper wishbone on rear axles on MAN types TGA and F2000

MAN LKW



Profile	Size	Length	Part no.
○	17 mm	170 mm	10111L

## Truck silent bearing set



17 t hydraulic cylinder and pressure pieces for replacing the rubber mountings or metal mountings e.g. on leaf springs.



Part no.  
302600L

## All-in-one tool



truck silent bearing tool with hydraulic cylinder for replacement of the rubber/metal bearings e.g. on the leaf springs for Volvo and Scania or passenger cars and pickups.

Volvo LKW  
Scania LKW



Part no.  
302601L

## Half-shell set supplement

for the half-shell set 301372L size G.

Includes tension bolt (M20 x M16) + collar nut for installation of the long bus bearings.



MAN  
MAN LKW



Description	Part no.
Installation silent bearing 45 mm diameter (e.g. MAN bus)	301384L

## Half-shell set

for changing silent bearings on trucks.



Description	Part no.
Silent bearings 57 mm diameter BPW bearings on bellows carrier	301377L

## Tension / thrust sleeve set

For the removal and retraction of silent bearings, hydraulic bearings, bushings, ball bearings, rubber bearings, etc. to passenger cars and commercial vehicles. Also to be used for rubber bushes and radial sealing rings

- slightly supported by industrial ball bearing on the spindle nut
- four spindles in 350 mm length, M10, M12, M14 and M16
- eight pressure nuts with bearing: M10, M12, M14, M16
- 20 pressure pieces, slit for visual inspection
- can also be used with a workshop press or press frame

### Dimensions of the sleeves:

Outer Ø Inner Ø [mm] Height inside - 50 mm

- 44/34 - 46/36 - 48/38 - 50/40 - 52/42 - 54/44 - 56/46 - 58/48 - 60/50 - 62/52
- 64/54 - 66/56 - 68/58 - 70/60 - 72/62 - 74/64 - 76/66 - 78/68 - 80/70 - 82/72



ⓘ Trapezoid thread for high pressure!

Description	Part no.
32-piece	10032L
Tr10 x 2.0 spindle	10032L-2
Tr12 x 2.0 spindle	10032L-3
Tr14 x 2.5 spindle	10032L-4
Tr16 x 3.0 spindle	10032L-5
M18 x 1.5 spindle	10032L-6

## Pressing clamp

For the removal and retraction of silent bearings, hydraulic bearings, bushings, ball bearings, rubber bearings, etc. to passenger cars and commercial vehicles.



ⓘ To be used with 10032L tension /thrust sleeve set and with 09681L hydraulic spindle 12 t!

Description	Part no.
220 mm clamping range	10032L-1



## Supporting joint tool



for replacing the upper supporting joints on:

- VW T4



VW

Part no.  
302401L

## Pressure piece set



for upper front axle ball joints (46 mm diameter)

- Opel (Vauxhall) Movano from '98
- Nissan Interstar from '02
- Renault Master from '98
- VW T4 '90-'03

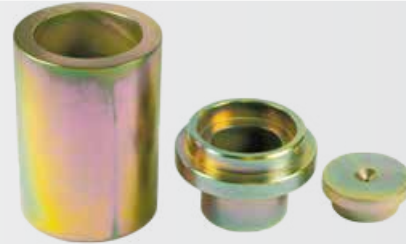

VW  
Nissan  
Opel  
Renault

① In combination with pressing frame.

Description	Part no.
Pressure piece set	301266L
Pressure pad	301267L

## Ball joint tool set



to press the ball joints with a press frame and 20 pressure pieces.

For the upper ball joint on

- VW T4, Crafter
- Mercedes-Benz Sprinter
- Renault Master
- Opel Movano
- Nissan Interstar

For the lower ball joint on

- VW LT Mercedes-Benz Sprinter
- Renault Master from '06
- Opel Movano
- Nissan Interstar
- Iveco



Nissan  
Renault  
Iveco  
Mercedes-Benz  
Opel  
VW

Description	Part no.
Pressing frame with 20 adapters	302406L

## Ball joint tool set



to press the ball joints with press frame and 10 pressure pieces.

For the upper ball joint on

- VW T4
- Renault Master
- Opel Movano
- Nissan Interstar

For the lower ball joint on

- VW LT
- Mercedes-Benz Sprinter



Opel  
Nissan  
Renault  
VW  
Mercedes-Benz

Description	Part no.
Pressing frame with 10 adapters	302407L



## Ball joint tool set

to press the ball joints with a press frame and 6 pressure pieces.

For the upper ball joint on

- VW T4

For the lower ball joint on

- VW LT
- Mercedes-Benz Sprinter



  
VW  
Mercedes-Benz



Description	Part no.
Pressing frame with 6 adapters	302411L

## Pressure piece

for 302411L to dismantle ball joints for

- VW Crafter
- Mercedes-Benz Sprinter 906



  
VW  
Mercedes-Benz

Description	Part no.
Pressure piece for supporting joint MB Sprinter 906, VW Crafter	302412L

## Ball-joint remover

for pressing the supporting joint cone out of from the axle leg in Mercedes-Benz Sprinter and VW LT.

360 x 360 mm support.



  
Mercedes-Benz  
VW

Description	Part no.
	302403L

## Ball-joint remover

for universal use with trucks/commercial vehicles

- with two seats 24 + 32 mm width
- with oil hydraulic spindle for easy and fast work
- clamping range: 55 105 mm

 **Warning: Clean and lubricate the screw with grease (MOS2), before using it.**



  
Mercedes-Benz

Description	Part no.
24 + 32 mm width	10004L

## Pry bar set

Pry bar for all applications in the truck and agricultural vehicles sector. With plastic soft grip, single-piece blade and impact cap. Ideal for supporting joints, bearing and separating work. High-strength version.

- 900 mm straight
- 900 mm 45° angled
- 600 mm 75° angled
- 600 mm 90° angled



  
Mercedes-Benz

Description	Part no.
4-piece	10104L



## Pressure piece set



for wishbone front axle, Ø 38 mm.

Mercedes-Benz  
VW

- Mercedes-Benz Sprinter from '95-'06
- VW LT from '97-'06

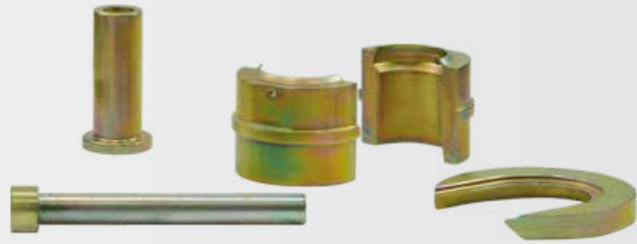

ⓘ In combination with 301201L mechanically powered!

Description	Part no.
Pressure piece set	301419L

## Pressure piece set



for replacing silent bearings from lower wishbone of the front axle, Ø 35/45 mm.

VW  
Seat  
Ford

- VW T4 '90-'03, (45 mm slotted)
- VW T4 '90-'03 (35 mm lower front axle)
- VW Sharan '95
- Ford Galaxy '95
- Seat Alhambra '96 (wishbone front and rear axle)



ⓘ In combination with 301201L mechanically powered!

Description	Part no.
Pressure piece set	301257L

## Wheel bearing removal tool



for commercial vehicles for the removal of the wheel hub with bearing and brake disc without drive.

- For 180 - 240 mm diameter for 10-hole wheel hubs, fixed by 4-point seat
- Suitable for ZF axles (AVN, AV132) e.g. Solaris buses

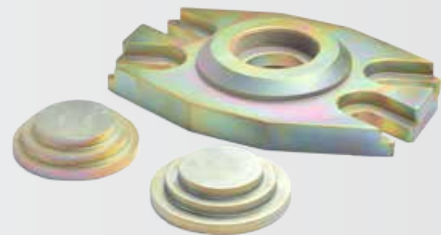

ⓘ without drive

Description	Part no.
Wheel bearing removal tool - without drive	301528L

## Complete tool



to replace the rubber on the rear axle wishbone.

VW

- Suitable for:
- VW T5



Part no.
302330L

## Battery charger



Fully automatic process-controlled charger, especially suitable for mobile homes, buses, agricultural machinery, boats and rehabilitation vehicles for capacities from 14 Ah to 230 Ah and from 14 Ah to 120 Ah.

The Charge Box 7.0 can be switched from 12 V to 24 V.  
 • Pulse charge + maintenance charge + permanent charging function

Delivery:  
 Charge Box 7.0 with adapter cable (pole clamps, lugs, cigarette lighter) and pocket.



Battery capacity	Charging voltage	Charging current	Part no.
12V 14 to 230 / 24V 14 to 120 Ah	14,4 / 14,7 / 28,8 / 29,4 V	7 / 5 / 3,5 / 1,5 A	34070L

## Battery charger



Fully automatic processor-controlled charging computer with LCD display. For all 12 and 24 V lead-acid batteries (wet, gel, AGM).

- Mains voltage 120 - 240 V ~ 50 / 60 Hz
- Possible charging current 12V / 24V – 5A or 10A
- Inverse polarity and overheating protection, without sparking
- Digital display of current voltage (Volt = V) and charging current (Ampere = I)
- Ideal for maintenance charge (e.g. during programming or fault queries), permanent charge and pulse charge
- Incl. two permanently connected terminal clamps



Charging voltage	Charging current	Part no.
12 / 24 V	12V / 24V - 5A / 10A	34100L

## Unlocking tool set

for the removal of different contact systems (ABS, air-conditioning, sensors...). The professional use prevents damage to housing or contact.

- Suitable for round and blade-type contacts
- Protective cap over the tool tip prevents damage to the blade when not in use



Volvo  
MAN

Description	Part no.
Special set for MAN / Volvo, 14-piece	32150L

## Digital multimeter



acoustic transition tester, transistor test, capacity and frequency measurement, data retaining function, automatic range selection.

- DC voltage up to 600 V
- AC voltage up to 600 V
- Direct current up to 10 A
- Alternating current up to 10 A
- Resistance up to 40 MOhm
- Capacity up to 40 mF
- Frequency: 10 Hz - 10 MHz
- 9 V battery



Description	Part no.
Multimeter	32235L
Replacement testing tips, 1 pair	32231L

## Measuring cable set

an ideal addition to 32220L / 32230L and 32235L circuit analysers.

The set includes a pre-manufactured test cable, 190 mm long, in yellow, red, black and blue with different connections such as:

- in each set 3 pcs. blade terminal, flat sleeve, round plug, round sleeve, point cable plug, point cable sleeve
- 2 x connection cable set 1,000 mm (red / black) – enables elongation to 2,000 mm in total
- 2 crocodile clips (red / black) with a jaw opening of up to 25 mm
- 1 set of testing tips - red / black - (in combination with a connection cable)
- 2 sets of testing needles, 220 mm cable length, red / black – for plugging into the cable to be tested (in combination with a connection cable)
- 2 pcs. 2-colour-LED-test cable for determining the polarity (together with testing tips/needles or crocodile clips – with the correct polarity, the LED lights up green and with the wrong polarity, red)
- 2 test resistances 0.25 A (yellow) for the SRS airbag and belt tightening systems
- 2 bridge plugs '2 in 1' (black)
- 2 potentiometers 5K ohm (infinitely adjustable)
- Measuring cable set



**Description**  
92-piece

**Part no.**  
32225L

## Multitester

or passenger cars and trucks, for testing the on-board electric systems 6 - 24 Volt, different special applications are possible:

- thermo switch testing
- wiper motor or petrol pump testing in fitted condition
- trailer coupling testing
- suitable as diode test device



① **Testing of trailer power supply possible**

**Measuring range: voltage AC/DC**  
6 - 24 V

**Part no.**  
32255L

## Fuse ammeter

or the fast measurement of direct current on trucks, passenger cars and motorbikes via the contact of standard plug-in fuses (ATO fuses), also has an adapter for mini fuses. Ideal for determining closed circuit current consumers.

- 0.1 to 19.9 A
- with LCD display
- LED lighting
- 20 A inherent fuse protection
- including button battery (CR2032)



① **Note: Not suitable for diagnosing short-circuits**

**Part no.**  
32224L





# SAUER

Das Werkzeug



**SAUER**  
Das Werkzeug  
80 2 10000  
MAX 700 bar  
16/02865/21



▶ Basic Sets	800-804
▶ Wheel Bearing Tools	805
▶ Bush Tools	805
▶ Drive Set Hydraulic	806-807
▶ Drive Set Manual	808-810
▶ Press Frames / Press Tools	810-812
▶ Spindles and Nuts	812-813
▶ Pressure and Support Sleeves	814-817
▶ Adapters	818





## SAUER Drive Set, Hydraulic



This basic set is used as a hydraulic drive for almost all tensioning and press work on wheel bearings, drive shafts, rubber bearings and supporting joints. In combination with the Sauer press frames or the Sauer pressure pieces, this set is a must for any workshop.



Description	Part no.
Drive set, hydraulic	80220033
Hydraulic cylinder	80210000
M12 × 450 mm feed shaft, with nut	80220007
M14 × 450 mm feed shaft, with nut	80220010
M20 × 450 mm feed shaft, with nut	80220025
450 mm pressure spindle	80220059
Adapter with ø 30 mm socket	80220046
Adapter with ø 35 mm socket	81200096
For vehicle pressure pieces	80220003
Pressure mandrel, 100 mm	81200097
Pressure mandrel, 25 mm	81200098

## SAUER Basic Set with Press Frame



With universal press frame in closed design and 20 t hydraulic cylinder. Designed to fit universal pressure and support sleeves with 30 mm connectors.



Description	Part no.
Basic set	81230500
Hydraulic cylinder	80210000
Press frame, closed design	80220047
450 mm pressure spindle	80220059
Pressure mandrel, 25 mm	81200098

## SAUER Basic Set with Press Frame



With press frame for vehicle pressure and support sleeves and 20 t hydraulic cylinder.



Description	Part no.
Basic set	81230600
Hydraulic cylinder	80210000
Press frame, open design	80220032
450 mm pressure spindle	80220059
Pressure mandrel, 25 mm	81200098

## SAUER Pressure and Support Sleeve Set, Hydraulic



Universal pressure and support sleeve set with internal diameters of 22 to 68 mm and lengths of 40 mm and 100 mm, incl. hydraulic cylinder and press frame.



Description	Part no.
Pressure and support sleeve set	81230900
Hydraulic cylinder	80210000
Press frame, closed design	80220047
450 mm pressure spindle	80220059
Pressure mandrel, 25 mm	81200098
Pressure piece set, long, ø 30–68 mm	81230700
Pressure piece set, short, ø 22–60 mm	81230800



## SAUER Pressure and Support Sleeve Set, Manual

Universal pressure and support sleeve set with internal diameters of 22 to 68 mm and lengths of 40 mm and 100 mm, incl. manual pressure spindle, socket adapter, and press frame.



Description	Part no.
Pressure and support sleeve set	81231600
Press frame, closed design	80220047
Pressure spindle and feed shaft TR20x450	81230401
Socket adapter	81230403
Adapter TR20 to M42	81230402
Adapter TR20 to 2 1/4"-14	81230404
Pressure mandrel, 25 mm	81200098
Pressure piece set long, ø 30 - 68 mm	81230700
Pressure piece set short, ø 22 - 60 mm	81230800

## SAUER Pressure and Support Sleeve Set

Universal pressure and support sleeve set with internal diameters of 22 to 68 mm and lengths of 40 mm and 100 mm. Without drive.



Description	Part no.
Pressure and support sleeve set	81231000
Press frame, closed design	80220047
Pressure mandrel, 25 mm	81200098
Pressure piece set long, ø 30 - 68 mm	81230700
Pressure piece set short, ø 22 - 60 mm	81230800

## SAUER Pressing Clamp Set

The Sauer pressing clamp is designed for work directly on the vehicle and can be operated both manually and hydraulically.

### Description:

Internal length: 230 mm  
 Socket thread 1: M42 × 2.0  
 Socket thread 2: M42 × 2.0  
 Max. load: 12 tonnes  
 Weight: 6.6 kg



Description	Part no.
Pressing clamp set	81230300
Pressing clamp, single	81230301
Threaded sleeve	80220036
Drive set, manual	81230400

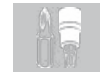



## SAUER Drive Set, manual



This basic set contains almost all components for manual tensioning and pressing work on wheel bearings, drive shafts, rubber bearings and supporting joints. The trapezoid thread used ensures long-term durability even under the highest loads. Naturally, the set perfectly matches the Sauer pressure and support sleeve sets, press frames, and pressing clamps.



Description	Part no.
Drive set manuel	81231400
TR10x350 feed shaft	80220054
TR12x350 feed shaft	80220055
TR14x350 feed shaft	80220056
TR16x350 feed shaft	80220057
TR18x350 feed shaft	80220058
TR10 nut	80220062
TR12 nut	80220063
TR14 nut	80220064
TR16 nut	80220065
TR18 nut	80220066
Bearing adapter	80220061
Pressure spindle and feed shaft TR20x450	81230401
Socket adapter	81230403
Adapter TR20 to M42	81230402
Adapter TR20 to 2 1/4"-14	81230404
TR20 nut	81230405

## SAUER Drive Set, manual



This drive set is designed for the manual changing of rubber bearings for axle suspension parts. Naturally, the set perfectly matches the Sauer pressure and support sleeve sets.



Description	Part no.
Drive set manuel	81231500
TR10x350 feed shaft	80220054
TR12x350 feed shaft	80220055
TR14x350 feed shaft	80220056
TR16x350 feed shaft	80220057
TR18x350 feed shaft	80220058
TR10 nut	80220062
TR12 nut	80220063
TR14 nut	80220064
TR16 nut	80220065
TR18 nut	80220066
Bearing adapter	80220061

## SAUER Drive Set for Manual Tensioning and Pressing



This drive set is designed for the manual changing of wheel bearings and supporting joints, as well as for pressing out drive shafts. Naturally, the set perfectly matches the Sauer pressure and support sleeve sets.



Description	Part no.
Drive set, manuel	81230400
Pressure spindle and feed shaft TR20x450	81230401
Adapter TR20 to M42	81230402
Socket adapter	81230403
Adapter TR20 to 2 1/4"-14	81230404
TR20 nut	81230405

## SAUER Pressure and Support Sleeve Set, $\varnothing$ 18–78 mm



Universal pressure and support sleeve set with internal diameters of 18 to 78 mm and lengths of 40 mm, 100 mm, and 120 mm.

Ideal for removing and installing rubber bearings and supporting joints.

### Contents:

- Pressure and support sleeves,  $\varnothing$  18–78 mm, length 40 mm
- Pressure and support sleeves,  $\varnothing$  26–70 mm, length 100 mm
- Pressure/support sleeves  $\varnothing$  72–78 mm, length 120 mm



### Description

Pressure and support sleeve set,  $\varnothing$  18 – 78 mm, 54-piece

### Part no.

81230200

## SAUER Pressure and Support Sleeve Set, $\varnothing$ 72–108 mm



Universal pressure and support sleeve set with internal diameters of 72 to 108 mm and lengths of 40 mm, 120 mm, and 150 mm.

Ideal for removing and installing rubber bearings and wheel bearings.

### Contents:

- Pressure / support sleeves  $\varnothing$  72–100 mm, length 40 mm
- Pressure / support sleeves  $\varnothing$  80–100 mm, length 120 mm
- Pressure / support sleeves  $\varnothing$  102–108 mm, length 150 mm



### Description

Pressure and support sleeve set,  $\varnothing$  72 – 108 mm, 30-piece

### Part no.

81230000

## SAUER Pressure and support sleeve set, $\varnothing$ 102 – 120 mm



Universal pressure and support sleeve set with internal diameters of 102 to 120 mm and lengths of 40 mm and 150 mm.

Ideal for commercial vehicles.

### Contents:

- Pressure/support sleeves  $\varnothing$  102–112 mm, length 40 mm
- Pressure/support sleeves  $\varnothing$  110–120 mm, length 150 mm



### Description

Pressure and support sleeve set,  $\varnothing$  102 – 120 mm, 12-piece

### Part no.

81230100

## SAUER Pressure and Support Sleeve Set, $\varnothing$ 102–120 mm



Comprehensive universal set for removing and installing rubber bearings and supporting joints.

20-piece

### Contents:

- Pressure and support sleeves,  $\varnothing$  30–68 mm, length 100 mm



### Description

Pressure piece set long,  $\varnothing$  30 - 68 mm, 20-piece

### Part no.

81230700





## SAUER Pressure Sleeve Set, $\varnothing$ 22–60 mm



Comprehensive universal set for removing and installing rubber bearings and supporting joints.

Contents:

- Pressure sleeves,  $\varnothing$  22–60 mm, length 40 mm



Description	Part no.
Pressure sleeve set short, $\varnothing$ 22 - 60 mm, 20-piece	81230800

## SAUER Support Sleeve Set, $\varnothing$ 30–90 mm



Comprehensive universal set for removing and installing rubber bearings and supporting joints.

Contents:

- Support sleeves,  $\varnothing$  30–70 mm, length 100 mm
- Support sleeves,  $\varnothing$  72–90 mm, length 120 mm



Description	Part no.
Support sleeve set long, $\varnothing$ 30 - 90 mm, 31-piece	81231100

## SAUER Pressure Sleeve Set, $\varnothing$ 22–82 mm



Comprehensive universal set for removing and installing rubber bearings and supporting joints.

Contents:

- Support sleeves,  $\varnothing$  22–82 mm, length 40 mm



Description	Part no.
Pressure sleeve set long, $\varnothing$ 22 - 82 mm, 31-piece	81231200

## SAUER Cylinder Holder



This cylinder holder made of aluminium can be deployed rapidly and is highly flexible. The Sauer adapter plates and/or press frames are fitted with an additional holder, which can be quickly and easily inserted into the holding device of the cylinder holder and locked in place. The holding device can be rotated and fixed in place in any position with a locking handle. The cylinder holder may be mounted on any standard transmission jack with a  $\varnothing$  30 mm piston rod. Adapters for transmission jacks with  $\varnothing$  25 mm and  $\varnothing$  36 mm piston rods can be added at any time.

The scope of delivery of the set also includes screw-on holders for Sauer press frames and adapter plates, as well as a socket for transmission jacks with a piston rod diameter of 30 mm. The provided foam insert ensures damage-free storage.



Description	Part no.
Cylinder holder	80220100
$\varnothing$ 30 mm retaining tube for 80220100	80220102
$\varnothing$ 25 mm retaining tube for 80220100	80220101
$\varnothing$ 36 mm retaining tube for 80220100	80220103
Pressing clamp holder for 81230301	80220114

## SAUER Plastic Case

Plastic storage case

Size: 575 × 355 × 172 mm



Description	Part no.
Plastic case	80290030

## SAUER Internal Bearing Ring Removal Set, ø 40–61 mm

Ideal for removing bearing rings that lie flat, which often remain on the hub when removing wheel bearings.

Universal; for all vehicle types and internal bearing rings with an internal diameter of 35–55 mm.

- Jaw width: 40–61 mm



Description	Part no.
Remover set	81231300
ø 58,9 mm ring spanner	81231301
ø 82,7 mm ring spanner	81231302
Pressure spindle with cone M20 x 1,5	81231303
Removing house	81231304
Remover socket ø 40 - 45 mm	81231305
Remover socket ø 45 - 51 mm	81231306
Remover socket ø 50 - 55 mm	81231307
Remover socket ø 55 - 61 mm	81231308

## Bush Tools

### Rubber bearing tool VAG

for the removal and installation of the plastic bearing on the console mule without removing the console (front axle 62 mm diameter)

Suitable for:

- Audi A2 '00 - '05
- Seat Cordoba 6L '02 - '09, Ibiza 6L '02 - '09
- Škoda Fabia 6Y '99 - '08, Roomster 5J '06 - '08
- VW Fox 5Z '05 - '12, Polo 9N '01 - '09

As well as for bearing bracket (removal necessary) to:

- Audi A3 8P '03 - '13
- Seat Altea 5P '04 - '15, Leon 1P '05 - '13, Toledo 5P '04 - '09
- Škoda Octavia 1Z '04 - '13, Superb 3T '08 - '10, Yeti 5L '09 - '10
- VW Caddy III 2K '03 - '10, Eos 1F '06 --, Golf V 1K '03 - '10, Golf VI 5K '08 - '13, Golf Plus 5M '05 - '14, Scirocco 13 '08 --, Jetta III 1K '05 - '10, Passat 3C '05 - '15, Touran 1T1 '03 - '10, Touran 1T3 '10 - '15, Tiguan 5N '07 - '16



Seat  
Audi  
VW  
Škoda

Description	Part no.
Silent pressure sleeve complete	81110400
ø 90 mm pressure sleeve	81110401
ø 61,4 mm pressure sleeve	81110402
ø 70 mm pressure sleeve	81110404
Pressure pad with bearing	81110407
M16 x 180 mm tension bolt	81110502
M16 nut	80220017



## SAUER Aluminium Hydraulic Cylinder, 20 t



High-performance hydraulic cylinder with a max. pressing force of 20 tonnes.

The hydraulic cylinder is made of steel and aluminium, and currently lightest hydraulic cylinder on the market at 3.4 kg.

### Description:

- Hollow piston cylinder with quick coupling and aluminium thread protector
- Maximum force: 20 t
- Socket for threaded spindle: M20 × 2.5
- Screw thread on pressure side: 2 1/4" – 14 UNS
- Screw thread on tensioning side: M42 × 2.0
- Stroke: 50 mm
- Weight: 3.4 kg
- Dimensions: ø 89 mm × 160 mm



Description	Part no.
Hydraulic cylinder	80210000
Replacement quick coupling	80210001

## SAUER Aluminium Hydraulic Foot Pump, 700 bar



Small but powerful aluminium foot pump for operating the Sauer hydraulic cylinder incl. pressure gauge and high-pressure hydraulic hose. The low weight makes the pump very handy. Unlike with hand pumps, it leaves both hands free to operate the tool or cylinder.

### Description:

- Aluminium hydraulic foot pump
- Incl. glycerine-filled pressure gauge
- Incl. high-pressure hydraulic hose with quick coupling, 2.50 metres
- Max. pressure: 700 bar
- Weight: 5.5 kg
- Dimensions without hose: 400 × 200 × 150 mm (L × W × H)



Description	Part no.
Hydraulic foot pump	80210100
Storage case	80210103
Replacement pressure gauge	80210101
Replacement hydraulic hose	80210102

## SAUER Drive Set, Hydraulic



This basic set is used as a hydraulic drive for almost all tensioning and press work on wheel bearings, drive shafts, rubber bearings and supporting joints. In combination with the Sauer press frames or the Sauer pressure pieces, this set is a must for any workshop.



Description	Part no.
Drive set hydraulic	80220033
Hydraulic cylinder	80210000
M12 x 450 mm feed shaft, with nut	80220007
M14 x 450 mm feed shaft, with nut	80220010
M20 x 450 mm feed shaft, with nut	80220025
Pressure spindle 450 mm	80220059
Adapter with ø 30 mm socket	80220046
Adapter with ø 35 mm socket	81200096
For vehicle pressure pressure pieces	80220003
Pressure mandrel, 100 mm	81200097
Pressure mandrel, 25 mm	81200098

## SAUER Basic Set with Press Frame

YYY

With universal press frame in closed design and 20 t hydraulic cylinder. Designed to fit universal pressure and support sleeves with 30 mm connectors.

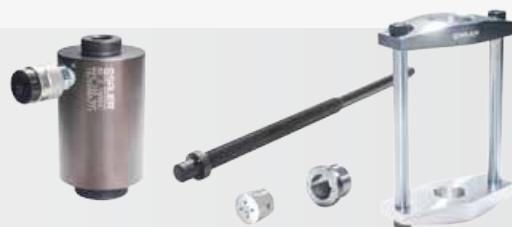

Description	Part no.
Basic set	81230500
Hydraulic cylinder	80210000
Press frame, closed design	80220047
Pressure spindle 450 mm	80220059
Pressure mandrel 25 mm	81200098

## SAUER Basic set with Press frame

YYY

With press frame for vehicle pressure and support sleeves and 20 t hydraulic cylinder.



Description	Part no.
Basic set	81230600
Hydraulic cylinder	80210000
Press frame, open design	80220032
Pressure spindle 450 mm	80220059
Pressure mandrel, 25 mm	81200098

## SAUER Pressure and support sleeve set, hydraulic

YYY

Universal pressure and support sleeve set with internal diameters of 22 to 68 mm and lengths of 40 mm and 100 mm, incl. hydraulic cylinder and press frame.



Description	Part no.
Pressure and support sleeve set	81230900
Hydraulic cylinder	80210000
Press frame, closed design	80220047
Pressure spindle 450 mm	80220059
Pressure mandrel, 25 mm	81200098
Pressure piece set long, $\varnothing$ 30 - 68 mm	81230700
Pressure piece set short, $\varnothing$ 22 - 60 mm	81230800

## SAUER Cylinder holder

YYY

This cylinder holder made of aluminium can be deployed rapidly and is highly flexible. The Sauer adapter plates and/or press frames are fitted with an additional holder, which can be quickly and easily inserted into the holding device of the cylinder holder and locked in place. The holding device can be rotated and fixed in place in any position with a locking handle. The cylinder holder may be mounted on any standard transmission jack with a  $\varnothing$  30 mm piston rod. Adapters for transmission jacks with  $\varnothing$  25 mm and  $\varnothing$  36 mm piston rods can be added at any time. The scope of delivery of the set also includes screw-on holders for Sauer press frames and adapter plates, as well as a socket for transmission jacks with a piston rod diameter of 30 mm. The provided foam insert ensures damage-free storage.



Description	Part no.
Cylinder holder	80220100
$\varnothing$ 30 mm replacement retaining tube for 80220100	80220102
$\varnothing$ 25 mm retaining tube for 80220100	80220101
$\varnothing$ 36 mm retaining tube for 80220100	80220103
Pressing clamp holder for 81230301	80220114





## SAUER Pressure mandrel, short

Lenght 25 mm



Description	Part no.
Pressure mandrel, 25 mm	81200098

## SAUER Pressure mandrel, long

Lenght 100 mm



Description	Part no.
Pressure mandrel, 100 mm	81200097

# Drive Set Manual

## SAUER Drive set manuel

This basic set contains almost all components for manual tensioning and pressing work on wheel bearings, drive shafts, rubber bearings and supporting joints. The trapezoid thread used ensures long-term durability even under the highest loads. Naturally, the set perfectly matches the Sauer pressure and support sleeve sets, press frames, and pressing clamps.



Description	Part no.
Drive set manuel	81231400
TR10x350 feed shaft	80220054
TR12x350 feed shaft	80220055
TR14x350 feed shaft	80220056
TR16x350 feed shaft	80220057
TR18x350 feed shaft	80220058
TR10 nut	80220062
TR12 nut	80220063
TR14 nut	80220064
TR16 nut	80220065
TR18 nut	80220066
Bearing adapter	80220061
Pressure spindle and feed shaft TR20x450	81230401
Socket adapter	81230403
Adapter TR20 to M42	81230402
Adapter TR20 to 2 1/4"-14	81230404
TR20 nut	81230405

## SAUER Pressure and Support Sleeve Set, Manual

Universal pressure and support sleeve set with internal diameters of 22 to 68 mm and lengths of 40 mm and 100 mm, incl. manual pressure spindle, socket adapter, and press frame.



Description	Part no.
Pressure and support sleeve set	81231600
Press frame, closed design	80220047
Pressure spindle and feed shaft TR20x450	81230401
Socket adapter	81230403
Adapter TR20 to M42	81230402
Adapter TR20 to 2 1/4"-14	81230404
Pressure mandrel, 25 mm	81200098
Pressure piece set long, ø 30 - 68 mm	81230700
Pressure piece set short, ø 22 - 60 mm	81230800



## SAUER Drive Set, manual



This drive set is designed for the manual changing of rubber bearings for axle suspension parts. Naturally, the set perfectly matches the Sauer pressure and support sleeve sets.



Description	Part no.
Drive set manual	81231500
TR10x350 feed shaft	80220054
TR12x350 feed shaft	80220055
TR14x350 feed shaft	80220056
TR16x350 feed shaft	80220057
TR18x350 feed shaft	80220058
TR10 nut	80220062
TR12 nut	80220063
TR14 nut	80220064
TR16 nut	80220065
TR18 nut	80220066
Adapter with bearing	80220061

## SAUER Drive Set for Manual Tensioning and Pressing



This drive set is designed for the manual changing of wheel bearings and supporting joints, as well as for pressing out drive shafts. Naturally, the set perfectly matches the Sauer pressure and support sleeve sets.



Description	Part no.
Drive set, manuel	81230400
Pressure spindle and feed shaft TR20x450	81230401
Adapter TR20 to M42	81230402
Socket adapter	81230403
Adapter TR20 to 2 1/4"-14	81230404
TR20 nut	81230405

## SAUER Pressure mandrel, short



Lenght 25 mm



Description	Part no.
Pressure mandrel, 25 mm	81200098

## SAUER Pressure mandrel, long



Lenght 100 mm



Description	Part no.
Pressure mandrel, 100 mm	81200097

## SAUER Feed Shaft



For manual tensioning work.



Description	Part no.
TR10x350 feed shaft	80220054
TR12x350 feed shaft	80220055
TR14x350 feed shaft	80220056
TR16x350 feed shaft	80220057
TR18x350 feed shaft	80220058





## SAUER Nut



For manual feed rod with magnetic system and guide



Description	Part no.
TR10 nut	80220062
TR12 nut	80220063
TR14 nut	80220064
TR16 nut	80220065
TR18 nut	80220066

## SAUER Bearing Adapter



The bearing adapter is required when working with manual spindles.

The included axial ball bearing ensures low friction even when used under high loads.

With Sauer magnetic system.



Description	Part no.
Bearing adapter	80220061

## Press frames / Press Tools

### SAUER Press Frame, Closed Design



Sturdy press frame in closed design made of high-strength tempered steel. The enclosed threaded sleeve is designed for pressure pieces with  $\varnothing$  30 mm mounts and equipped with the Sauer magnet system. The height can be easily adjusted using the threaded sleeve.

#### Description:

- Internal width: 130 mm
- Internal length: 300 mm
- Socket thread 1: 2 1/4" – 14 UNS
- Socket thread 2: M42 x 2.0
- Max. load: 17 tonnes
- Weight: 5.5 kg



Description	Part no.
Press frame, closed design	80220047
Threaded sleeve	80220036
M42 press bridge	80220044
300 mm connector rod pair	80220041
2 1/4"-14 press bridge	80220045





## SAUER Cylinder Adapter



for cylinder holder 80220100



Description	Part no.
Cylinder holder 80220100	80220107

## Spindles and Nuts

### SAUER Feed Shaft with Nut



For hydraulic tensioning



Description	Part no.
M10 x 450 mm feed shaft, with nut	80220004
M12 x 450 mm feed shaft, with nut	80220007
M14 x 450 mm feed shaft, with nut	80220010
M14 x 590 mm feed shaft, with nut	80220013
M16 x 450 mm feed shaft, with nut	80220015
M16 x 590 mm feed shaft, with nut	80220018
M18 x 450 mm feed shaft, with nut	80220020
M18 x 590 mm feed shaft, with nut	80220023
M20 x 450 mm feed shaft, with nut	80220025
M20 x 590 mm feed shaft, with nut	80220028

### SAUER Feed Shaft



For hydraulic tensioning



Description	Part no.
M10 x 450 mm feed shaft, with nut	80220005
M12 x 450 mm feed shaft, with nut	80220008
M14 x 450 mm feed shaft, with nut	80220011
M14 x 590 mm feed shaft, with nut	80220014
M16 x 450 mm feed shaft, with nut	80220016
M16 x 590 mm feed shaft, with nut	80220019
M18 x 450 mm feed shaft, with nut	80220021
M18 x 590 mm feed shaft, with nut	80220024
M20 x 450 mm feed shaft, with nut	80220026
M20 x 590 mm feed shaft, with nut	80220029

### SAUER Nut



With magnetic system and guide, for hydraulic tensioning



Description	Part no.
M10 nut	80220006
M12 nut	80220009
M14 nut	80220012
M16 nut	80220017
M18 nut	80220022
M20 nut	80220027





## SAUER Pressure and Support Sleeve Set, $\varnothing$ 18 – 78 mm



Universal pressure and support sleeve set with internal diameters of 18 to 78 mm and lengths of 40 mm, 100 mm, and 120 mm.

Ideal for removing and installing rubber bearings and supporting joints.

**Contents:**

- Pressure and support sleeves,  $\varnothing$  18–78 mm, length 40 mm
- Pressure and support sleeves,  $\varnothing$  26–70 mm, length 100 mm
- Pressure/support sleeves  $\varnothing$  72–78 mm, length 120 mm



Description	Part no.
Pressure and support sleeve set, $\varnothing$ 18 – 78 mm, 54-piece	<b>81230200</b>

## SAUER Pressure and support sleeve set, $\varnothing$ 72 – 108 mm



Universal pressure and support sleeve set with internal diameters of 72 to 108 mm and lengths of 40 mm, 120 mm, and 150 mm.

Ideal for removing and installing rubber bearings and wheel bearings.

**Contents:**

- Pressure/support sleeves  $\varnothing$  72–100 mm, length 40 mm
- Pressure/support sleeves  $\varnothing$  80–100 mm, length 120 mm
- Pressure/support sleeves  $\varnothing$  102–108 mm, length 150 mm



Description	Part no.
Pressure and support sleeve set, $\varnothing$ 72 – 108 mm, 30-piece	<b>81230000</b>

## SAUER Pressure and support sleeve set, $\varnothing$ 102 – 120 mm



Universal pressure and support sleeve set with internal diameters of 102 to 120 mm and lengths of 40 mm and 150 mm.

Ideal for commercial vehicles.

**Contents:**

- Pressure/support sleeves  $\varnothing$  102–112 mm, length 40 mm
- Pressure/support sleeves  $\varnothing$  110–120 mm, length 150 mm



Description	Part no.
Pressure and support sleeve set, $\varnothing$ 102 – 120 mm, 12-piece	<b>81230100</b>

## SAUER Support Sleeve Set, $\varnothing$ 30–68 mm



Comprehensive universal set for removing and installing rubber bearings and supporting joints.

**Contents:**

- Support sleeves,  $\varnothing$  30–68 mm, length 100 mm

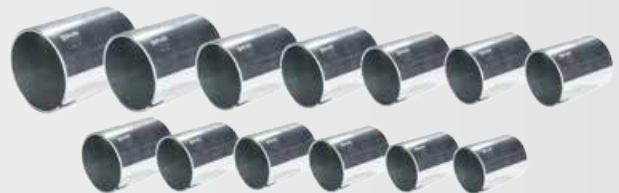

Description	Part no.
Support sleeves long, $\varnothing$ 30 - 68 mm, 20-piece	<b>81230700</b>

## SAUER Pressure Sleeve Set, $\varnothing$ 22–60 mm



Comprehensive universal set for removing and installing rubber bearings and supporting joints.

### Contents:

- Pressure sleeves,  $\varnothing$  22–60 mm, length 40 mm



### Description

Pressure sleeves set short,  $\varnothing$  22 - 60 mm, 20-piece

### Part no.

81230800

## SAUER Support Sleeve Set, $\varnothing$ 30–90 mm



Comprehensive universal set for removing and installing rubber bearings and supporting joints.

### Contents:

- Support sleeves,  $\varnothing$  30–70 mm, length 100 mm
- Support sleeves,  $\varnothing$  72–90 mm, length 120 mm



### Description

Support sleeves long,  $\varnothing$  30 - 90 mm, 31-piece

### Part no.

81231100

## SAUER Pressure Sleeve Set, $\varnothing$ 22–82 mm



Comprehensive universal set for removing and installing rubber bearings and supporting joints.

### Contents:

- Pressure sleeves,  $\varnothing$  22–82 mm, length 40 mm



### Description

Pressure sleeve set long,  $\varnothing$  22 - 82 mm, 31-piece

### Part no.

81231200

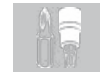

universal



### Description

### Part no.

Pressure sleeve ø 18/26 mm x 40 mm	81200001
Pressure sleeve ø 20/28 mm x 40 mm	81200002
Pressure sleeve ø 22/30 mm x 40 mm	81200003
Pressure sleeve ø 24/32 mm x 40 mm	81200004
Pressure sleeve ø 26/34 mm x 40 mm	81200005
Pressure sleeve ø 28/36 mm x 40 mm	81200006
Pressure sleeve ø 30/38 mm x 40 mm	81200007
Pressure sleeve ø 32/40 mm x 40 mm	81200008
Pressure sleeve ø 34/42 mm x 40 mm	81200009
Pressure sleeve ø 36/44 mm x 40 mm	81200010
Pressure sleeve ø 38/46 mm x 40 mm	81200011
Pressure sleeve ø 40/48 mm x 40 mm	81200012
Pressure sleeve ø 42/50 mm x 40 mm	81200013
Pressure sleeve ø 44/52 mm x 40 mm	81200014
Pressure sleeve ø 46/54 mm x 40 mm	81200015
Pressure sleeve ø 48/56 mm x 40 mm	81200016
Pressure sleeve ø 50/58 mm x 40 mm	81200017
Pressure sleeve ø 52/60 mm x 40 mm	81200018
Pressure sleeve ø 54/62 mm x 40 mm	81200019
Pressure sleeve ø 56/64 mm x 40 mm	81200020
Pressure sleeve ø 58/66 mm x 40 mm	81200021
Pressure sleeve ø 60/68 mm x 40 mm	81200022
Pressure sleeve ø 62/70 mm x 40 mm	81200023
Pressure sleeve ø 64/72 mm x 40 mm	81200024
Pressure sleeve ø 66/74 mm x 40 mm	81200025
Pressure sleeve ø 68/76 mm x 40 mm	81200026
Pressure sleeve ø 70/78 mm x 40 mm	81200027
Pressure sleeve ø 72/80 mm x 40 mm	81200028
Pressure sleeve ø 74/82 mm x 40 mm	81200029
Pressure sleeve ø 76/84 mm x 40 mm	81200030
Pressure sleeve ø 78/86 mm x 40 mm	81200031
Pressure sleeve ø 80/88 mm x 40 mm	81200032
Pressure sleeve ø 82/90 mm x 40 mm	81200033
Pressure sleeve ø 84/92 mm x 40 mm	81200034
Pressure sleeve ø 86/94 mm x 40 mm	81200035
Pressure sleeve ø 88/96 mm x 40 mm	81200036
Pressure sleeve ø 90/98 mm x 40 mm	81200037
Pressure sleeve ø 92/100 mm x 40 mm	81200038
Pressure sleeve ø 94/102 mm x 40 mm	81200039
Pressure sleeve ø 96/104 mm x 40 mm	81200040
Pressure sleeve ø 98/106 mm x 40 mm	81200041
Pressure sleeve ø 100/108 mm x 40 mm	81200042
Pressure sleeve ø 102/110 mm x 40 mm	81200043
Pressure sleeve ø 104/112 mm x 40 mm	81200044
Pressure sleeve ø 106/114 mm x 40 mm	81200045
Pressure sleeve ø 108/116 mm x 40 mm	81200046
Pressure sleeve ø 110/118 mm x 40 mm	81200047
Pressure sleeve ø 112/120 mm x 40 mm	81200048



## SAUER Support Sleeve



universal



Description	Part no.
Support sleeve ø 26/34 mm x 100 mm	81200099
Support sleeve ø 28/36 mm x 100 mm	81200049
Support sleeve ø 30/38 mm x 100 mm	81200050
Support sleeve ø 32/40 mm x 100 mm	81200051
Support sleeve ø 34/42 mm x 100 mm	81200052
Support sleeve ø 36/44 mm x 100 mm	81200053
Support sleeve ø 38/46 mm x 100 mm	81200054
Support sleeve ø 40/48 mm x 100 mm	81200055
Support sleeve ø 42/50 mm x 100 mm	81200056
Support sleeve ø 44/52 mm x 100 mm	81200057
Support sleeve ø 46/54 mm x 100 mm	81200058
Support sleeve ø 48/56 mm x 100 mm	81200059
Support sleeve ø 50/58 mm x 100 mm	81200060
Support sleeve ø 52/60 mm x 100 mm	81200061
Support sleeve ø 54/62 mm x 100 mm	81200062
Support sleeve ø 56/64 mm x 100 mm	81200063
Support sleeve ø 58/66 mm x 100 mm	81200064
Support sleeve ø 60/68 mm x 100 mm	81200065
Support sleeve ø 62/70 mm x 100 mm	81200066
Support sleeve ø 64/72 mm x 100 mm	81200067
Support sleeve ø 66/74 mm x 100 mm	81200068
Support sleeve ø 68/76 mm x 100 mm	81200069
Support sleeve ø 70/78 mm x 100 mm	81200070
Support sleeve ø 72/80 mm x 120 mm	81200071
Support sleeve ø 74/82 mm x 120 mm	81200072
Support sleeve ø 76/84 mm x 120 mm	81200073
Support sleeve ø 78/86 mm x 120 mm	81200074
Support sleeve ø 80/88 mm x 120 mm	81200075
Support sleeve ø 82/90 mm x 120 mm	81200076
Support sleeve ø 84/92 mm x 120 mm	81200077
Support sleeve ø 86/94 mm x 120 mm	81200078
Support sleeve ø 88/96 mm x 120 mm	81200079
Support sleeve ø 90/98 mm x 120 mm	81200080
Support sleeve ø 92/100 mm x 120 mm	81200081
Support sleeve ø 94/102 mm x 120 mm	81200082
Support sleeve ø 96/104 mm x 120 mm	81200083
Support sleeve ø 98/106 mm x 120 mm	81200084
Support sleeve ø 100/108 mm x 120 mm	81200085
Support sleeve ø 102/110 mm x 150 mm	81200086
Support sleeve ø 104/112 mm x 150 mm	81200087
Support sleeve ø 106/114 mm x 150 mm	81200088
Support sleeve ø 108/116 mm x 150 mm	81200089
Support sleeve ø 110/118 mm x 150 mm	81200090
Support sleeve ø 112/120 mm x 150 mm	81200091
Support sleeve ø 114/122 mm x 150 mm	81200092
Support sleeve ø 116/124 mm x 150 mm	81200093
Support sleeve ø 118/126 mm x 150 mm	81200094
Support sleeve ø 120/128 mm x 150 mm	81200095





## SAUER Hydraulic Adapter Set for Hydraulic Cylinders and Hydraulic Pumps



Hydraulic cylinders and pumps often have different connector systems for the hose lines. Not only do the screw diameters differ from one another, but the basic coupling systems differ considerably and often require multiple pumps or cylinders.

With this set, you can convert your tools to the most common coupling system. Adaptations from 1/4" to 3/8" or vice-versa are not a problem either. At last, your tools fit each other and can be combined.



Description	Part no.
Hydraulic adapter set	80190011
Teflon tape	80290000
3/8" NPT OT to 1/4" NPT IT	80290004
1/4" NPT OT to 3/8" NPT IT	80290005
Hydraulic coupling 3/8" loose half	80290010
Hydraulic coupling 3/8" fixed half	80290011
Hydraulic coupling 1/4" loose half	80290012
Hydraulic coupling 1/4" fixed half	80290013

## SAUER Thread Adapter Set for Hydraulic Cylinders and Press Frames



With this set, you can adapt your existing hydraulic cylinders and press frames from different manufacturers, allowing you to finally combine your tools with each other.

OT = outer thread  
IT = inner thread



Description	Part no.
Thread adapter set	80190010
OT 2 1/4" - 14 UNS, IT 2 1/4" - 16 UN	80290001
OT 2 1/4" - 16 UN, IT 2 1/4" - 14 UNS	80290021
OT 2 1/4" - 14 UNS, IT 2 3/4" - 16 UN	80290002
OT 2 3/4" - 16 UN, IT 2 1/4" - 14 UNS	80290019
OT 2 1/4" - 14 UNS, IT M68 x 2,0	80290003
OT M68 x 2,0, IT 2 1/4" - 14 UNS	80290020
OT M42 x 2,0, IT 2 1/4" - 14 UNS	80290022



# FURTHER USEFUL INFORMATION





# FURTHER USEFUL INFORMATION

**820-825**

- ▶ Conversion Table from Inches to Millimetres 822
- ▶ Conversion Table for Air Pressure from Psi to Bar 823
- ▶ Spanner Sizes for Multi-Profile Tools 823
- ▶ Inch-based Tools for Vintage & US Motorbikes 824
- ▶ Torque Conversion Table 824
- ▶ Force Conversion Table 824
- ▶ Core Hole Dimensions for Taps 825



Inch	0	1	2	3	4	5	6	7	8	9
0	-	25.40	50.80	76.20	101.60	127.00	152.40	177.80	203.20	228.60
1/64	0.40	25.80	51.20	76.60	102.00	127.40	152.80	178.20	203.60	229.00
1/32	0.79	26.19	51.59	76.99	102.39	127.79	153.19	178.59	203.99	229.39
3/64	1.19	26.59	51.99	77.39	102.79	128.19	153.59	178.99	204.39	229.79
1/16	1.59	26.99	52.39	77.79	103.19	128.59	153.99	179.39	204.79	230.19
5/64	1.98	27.38	52.78	78.18	103.58	128.98	154.38	179.78	205.18	230.58
3/32	2.38	27.78	53.18	78.58	103.98	129.38	154.78	180.18	205.58	230.98
7/64	2.78	28.18	53.58	78.98	104.38	129.78	155.18	180.58	205.98	231.38
1/8	3.18	28.58	53.98	79.38	104.78	130.18	155.58	180.98	206.38	231.78
9/64	3.57	28.97	54.37	79.77	105.17	130.57	155.97	181.37	206.77	232.17
5/32	3.97	29.37	54.77	80.17	105.57	130.97	156.37	181.77	207.17	232.57
11/64	4.37	29.77	55.17	80.57	105.97	131.37	156.77	182.17	207.57	232.97
3/16	4.76	30.16	55.55	80.96	106.36	131.76	157.16	182.56	207.96	233.36
13/64	5.16	30.56	55.96	81.36	106.76	132.16	157.56	182.96	208.36	233.76
7/32	5.56	30.96	56.36	81.76	107.16	132.56	157.96	183.36	208.76	234.16
15/64	5.95	31.35	56.75	82.15	107.55	132.95	158.35	183.75	209.15	234.55
1/4	6.35	31.75	57.15	<b>82.55</b>	107.95	133.35	158.75	184.15	209.55	234.95
17/64	6.75	32.15	57.55	82.95	108.35	133.75	159.15	184.55	209.95	235.35
9/32	7.14	32.54	57.94	83.34	108.74	134.14	159.54	184.94	210.34	235.74
19/64	7.54	32.94	58.34	83.74	109.14	134.54	159.94	185.34	210.74	236.14
5/16	7.94	33.34	58.74	84.14	109.54	134.94	160.34	185.74	211.14	236.54
21/64	8.33	33.73	59.13	84.53	109.93	135.33	160.73	186.13	211.53	236.93
11/32	8.73	34.13	59.53	84.93	110.33	135.73	161.13	186.53	211.93	237.33
23/64	9.13	34.53	59.93	85.33	110.73	136.13	161.53	186.93	212.33	237.73
3/8	9.53	34.93	60.33	85.73	111.13	136.53	161.93	187.33	212.73	238.13
25/64	9.92	35.32	60.72	86.12	111.52	136.92	162.32	187.72	213.12	238.52
13/32	10.32	35.72	61.12	86.52	111.92	137.32	162.72	188.12	213.52	238.92
27/64	10.72	36.12	61.52	86.92	112.32	137.72	163.12	188.52	213.92	239.32
7/16	11.11	36.51	61.91	87.31	112.71	138.11	163.51	188.91	214.31	239.71
29/64	11.51	36.91	62.31	87.71	113.11	138.51	163.91	189.31	214.71	240.11
15/32	11.91	37.31	62.71	88.11	113.51	138.91	164.31	189.71	215.11	240.51
31/64	12.30	37.70	63.10	88.50	113.90	139.30	164.70	190.10	215.50	240.90
1/2	12.70	38.10	63.50	88.90	114.30	139.70	165.10	190.50	215.90	241.30
33/64	13.10	38.50	63.90	89.30	114.70	140.10	165.50	190.90	216.30	241.70
17/32	13.49	38.89	64.29	89.69	115.09	140.49	165.89	191.29	216.69	242.09
35/64	13.89	39.29	64.69	90.09	115.49	140.89	166.29	191.69	217.09	242.49
9/16	14.29	39.69	65.09	90.49	115.89	141.29	166.69	192.09	217.49	242.89
37/64	14.68	40.08	65.48	90.88	116.28	141.68	167.08	192.48	217.88	243.28
19/32	15.08	40.48	65.88	91.28	116.68	142.08	167.48	192.88	218.28	243.68
39/64	15.48	40.88	66.28	91.68	117.08	142.48	167.88	193.28	218.68	244.08
5/8	15.88	41.28	66.68	92.08	117.48	142.88	168.28	193.68	219.08	244.48
41/64	16.27	41.67	67.07	92.47	117.87	143.27	168.67	194.07	219.47	244.87
21/32	16.67	42.07	67.47	92.87	118.27	143.67	169.07	194.47	219.87	245.27
43/64	17.07	42.47	67.87	93.27	118.67	144.07	169.47	194.87	220.27	245.67
11/16	17.46	42.86	68.26	93.66	119.06	144.46	169.86	195.26	220.66	246.06
45/64	17.86	43.26	68.66	94.06	119.46	144.86	170.26	195.66	221.06	246.46
23/32	18.26	43.66	69.06	94.46	119.86	145.26	170.66	196.06	221.46	246.86
47/64	18.65	44.05	69.45	94.85	120.25	145.65	171.05	196.45	221.85	247.25
3/4	19.05	44.45	69.85	95.25	120.65	146.05	171.45	196.85	222.25	247.65
49/64	19.45	44.85	70.25	95.65	121.05	146.45	171.85	197.25	222.65	248.05
25/32	19.84	45.24	70.64	96.04	121.44	146.84	172.24	197.64	223.04	248.44
51/64	20.24	45.64	71.04	96.44	121.84	147.24	172.64	198.04	223.44	248.84
13/16	20.64	46.04	71.44	96.84	122.24	147.64	173.04	198.44	223.84	249.24
53/64	21.03	46.43	71.83	97.23	122.63	148.03	173.43	198.83	224.23	249.63
27/32	21.43	46.83	72.23	97.63	123.03	148.43	173.83	199.23	224.63	250.03
55/64	21.83	47.23	72.63	98.03	123.43	148.83	174.23	199.63	225.03	250.43
7/8	22.23	47.63	73.03	98.43	123.83	149.23	174.63	200.03	225.43	250.83
57/64	22.62	48.02	73.42	98.82	124.22	149.62	175.02	200.42	225.82	251.22
29/32	23.02	48.42	73.82	99.22	124.62	150.02	175.42	200.82	226.22	251.62
59/64	23.42	48.82	74.22	99.62	125.02	150.42	175.82	201.22	226.62	252.02
15/16	23.81	49.21	74.61	100.01	125.41	150.81	176.21	201.61	227.01	252.41
61/64	24.21	49.61	75.01	100.41	125.81	151.21	176.61	202.01	227.41	252.81
31/32	24.61	50.01	75.41	100.81	126.21	151.61	177.01	202.41	227.81	253.21
63/64	25.00	50.40	75.80	101.20	126.60	152.00	177.40	202.80	228.20	253.60

## Air Pressure from Psi to Bar

psi	Bar	KPa	Atm
1	0.07	6.89	0.07
10	0.69	68.95	0.68
20	1.38	137.90	1.36
30	2.07	206.84	2.04
40	2.76	275.79	2.72
50	3.45	344.74	3.40
60	4.14	413.69	4.08
70	4.83	482.64	4.76
80	5.52	551.58	5.44
90	6.21	620.53	6.13
100	6.90	689.48	6.81
150	10.34	1034.22	10.21
200	13.79	1378.96	13.61
250	17.24	1723.70	17.01
300	20.69	2068.44	20.42

Bar	psi	KPa	Atm
1	15	100	0.99
2	29	200	1.97
3	44	300	2.96
4	58	400	3.95
5	73	500	4.93
6	87	600	5.92
7	102	700	6.91
8	116	800	7.90
9	131	900	8.88
10	145	1000	9.87
11	160	1100	10.86
12	174	1200	11.84
13	189	1300	12.83
14	203	1400	13.82
15	218	1500	14.81

## Assignment table for Multi-Profile '4-in-1' tools

Multi-Profile	Hexagonal	Bi-Hexagonal	Inch	Torx
4 mm	X	X	5/32"	E5
4.5 mm	X	X		E6
5 mm	X	X	3/16"	
5.5 mm	X	X		
6 mm	X	X	1/4"	E8
7 mm	X	X	9/32"	
8 mm	X	X	5/16"	E10
9 mm	X	X	11/32"	
10 mm	X	X	3/8"	E12
11 mm	X	X	7/16"	E14
12 mm	X	X	15/32"	E16
13 mm	X	X	1/2"	
14 mm	X	X		E18
15 mm	X	X	19/32"	
16 mm	X	X	5/8"	E20
17 mm	X	X		
18 mm	X	X		E22
19 mm	X	X	3/4"	E24
20 mm	X	X	25/32"	
21 mm	X	X		
22 mm	X	X	7/8"	
24 mm	X	X	15/16"	
27 mm	X	X	1 1/16"	
30 mm	X	X	1 1/8"	
32 mm	X	X	1 1/4"	





The different product categories in our catalogue also include inch-based tools for e.g. servicing and repairing vintage or US motorbikes. All of the products that contain inch-based tools are marked with a corresponding symbol.



When it comes to these tools, it is also important to be aware of the different thread standards, the most popular of which are:

DIN / ISO threads	BS (Whitworth) threads	UN (USA) threads
Standard Metric Thread (M)	British Standard (BSW)	Unified national (NC/UNC)
Metric Fine Thread (Mf)	British Standard Fine (BSF)	Unified National Fine (NF/UNF)
Metric dimensions, 60° thread angle, pitch = mm per rotation	Measured in inches, 55° thread angle, pitch = threads per Inch	Measured in inches, 60° thread angle, pitch = threads per Inch

## Torque Conversion Table (Original value line = Target value column)

	Nm	cNm	kgf m / kpm	kgf cm / kpcm	lbf in	lbf ft	ozf in	ozf ft	pdl in	pdl ft
Nm	1.000	100.0	0.102	10.20	8.850	0.738	141.6	11.80	284.8	23.73
cNm	0.010	1.000	0.001	0.102	0.089	0.007	1.416	0.118	2.848	0.237
kgf m / kpm	9.807	980.7	1.000	100.00	86.79	7.237	1389	115.7	2793	232.7
kgf cm / kpcm	0.098	9.807	0.010	1.000	0.868	0.072	13.89	1.157	27.93	2.327
lbf in	0.113	11.30	0.012	1.152	1.000	0.083	16.00	1.333	32.17	2.681
lbf ft	1.356	135.6	0.138	13.825	12.00	1.001	192.0	16.00	386.1	32.17
ozf in	0.007	0.706	0.001	0.072	0.062	0.005	1.000	0.083	2.011	0.168
ozf ft	0.085	8.474	0.009	0.864	0.750	0.063	12.00	1.000	24.13	2.011
pdl in	0.004	0.351	0.000	0.036	0.031	0.003	0.497	0.041	1.000	0.083
pdl ft	0.042	4.214	0.004	0.430	0.373	0.031	5.968	0.497	12.00	1.000

Example conversion of lbf ft into Nm: 160 lbf ft \* factor 1.356 = 217 Nm

### Legend

Nm	Newton metre	lbf ft	Pound-force
cNm	Centinewton metre	ozf in	Ounce-Force Inch
kgf m / kpm	Kilogram-force metres / Kilopond metres	ozf ft	Ounce-force feet
kgf cm / kpcm	Kilogram-force centimetre / Kilopond centimetres	pdl in	Poundal Inch
lbf in	Pound-force Inch	pdl ft	Poundal foot

## Force Conversion Table (Original value line = Target value column)

	N / kg m/s <sup>2</sup>	kN	kgf / kp	lbf	ozf	pdl
N / kg m/s <sup>2</sup>	1.000	0.001	0.102	0.225	3.597	7.233
kN	1000	1.000	102.0	224.8	3597	7233
kgf / kp	9.807	0.010	1.000	2.206	35.27	70.93
lbf	4.448	0.004	0.454	1.000	16.00	32.17
ozf	0.278	0.0003	0.028	0.063	1.000	2.011
pdl	0.138	0.0001	0.014	0.031	0.497	1.000

Example conversion of kgf to N: 1100 kg \* factor 9.807 = 10788 N

### Legend

N / kg m/s <sup>2</sup>	Newton / Kilogram m/s <sup>2</sup>	lbf	Pound-force
kN	Kilonewton	ozf	Ounce-force
kgf / kp	Kilogram-force / Kilopond	pdl	Poundal



## Recommended Core Hole Dimensions for Thread Cutting



SW-Stahl

Metric ISO Thread (M)	Ø mm	Metric ISO Fine Thread (Mf)	Ø mm	Metric ISO Fine Thread (Mf)	Ø mm
M1 x 0.25	0.75	M2.5 x 0.35	2.15	M14 x 1.5	12.5
M1.1 x 0.25	0.85	M2.6 x 0.35	2.25	M15 x 0.75	14.25
M1.2 x 0.25	0.95	M3 x 0.35	2.65	M15 x 1.0	14
M1.4 x 0.30	1.10	M3.5 x 0.35	3.15	M15 x 1.5	13.5
M1.6 x 0.35	1.25	M4 x 0.35	3.65	M16 x 0.5	15.5
M1.8 x 0.35	1.45	M4 x 0.5	3.5	M16 x 1.0	15
M2 x 0.4	1.60	M4.5 x 0.5	4	M16 x 0.75	15.25
M2.2 x 0.25	1.75	M5 x 0.5	4.5	M16 x 1.25	14.75
M2.5 x 0.45	2.05	M5 x 0.75	4.25	M18 x 0.5	17.5
M3 x 0.5	2.50	M5.5 x 0.5	5	M17 x 1.0	16
M3.5 x 0.6	2.90	M6 x 0.5	5.5	M18 x 1.0	17
M4 x 0.7	3.30	M6 x 0.75	5.2	M18 x 1.25	16.75
M4.5 x 0.75	3.70	M7 x 0.5	6.5	M18 x 1.5	16.5
M5 x 0.8	4.20	M7 x 0.75	6.2	M18 x 0.75	17.25
M6 x 1	5.00	M8 x 0.5	7.5	M18 x 2.0	16
M7 x 1	6.00	M8 x 0.75	7.2	M19 x 1.0	18
M8 x 1.25	6.80	M8 x 1.0	7	M19 x 1.5	17.5
M9 x 1.25	7.80	M9 x 0.5	8.5	M20 x 0.5	19.5
M10 x 1.5	8.50	M9 x 0.75	8.2	M20 x 1.0	19
M11 x 1.5	9.50	M9 x 1.0	8	M20 x 0.75	19.25
M12 x 1.75	10.20	M10 x 0.5	9.5	M20 x 1.25	18.75
M14 x 2	12.00	M10 x 0.75	9.2	M20 x 1.5	18.5
M16 x 2	14.00	M10 x 1.0	9	M20 x 2.0	18
M18 x 2.5	15.50	M10 x 1.25	8.8	M21 x 1.0	20
M20 x 2.5	17.50	M11 x 1.0	10	M21 x 1.5	19.5
M22 x 2.5	19.50	M11 x 1.25	9.8	M22 x 0.5	21.5
M24 x 3	21.00	M12 x 0.75	11.2	M22 x 1.0	21
		M12 x 1.0	11	M22 x 0.75	21.25
		M12 x 0.5	11.5	M22 x 1.25	20.75
		M12 x 1.25	10.8	M22 x 1.5	20.5
		M12 x 1.5	10.5	M22 x 2.0	20
		M13 x 0.5	12.5	M23 x 1.0	22
		M13 x 0.75	12.25	M23 x 1.5	21.5
		M13 x 1.0	12	M24 x 1.0	20.5
		M13 x 1.5	11.5	M24 x 0.5	23.5
		M14 x 0.75	13.25	M24 x 1.25	22.75
		M14 x 1.0	13	M24 x 0.75	23.25
		M14 x 1.25	12.8	M24 x 1.5	22.5
		M14 x 0.5	13.5	M24 x 2.0	22









Combined drill bit set	205
Compact bearing tool	479
Compact bearings tool set	478
Compressed air adapter	305
Compressed air adaptor	358
Compressed air bodywork saw	248
Compressed air hose	254
Compressed air hose drum	256
Compressed Air Maintenance Unit	253
Compressed air plug nipple	257
Compressed air plug nipple	257
Compressed air quick coupling, one-hand operation	256
Compressed air spray gun	250
Compressed air spray gun	250
Compressed air underbody protection gun	248
Compression and pressure loss tester	281
Compression tester	280
Connecting cable	609
Consumables dish	655
Contact file	218
Coolant system testing and filling device	285
Cooler adapter	386
Cooler squeeze off adapter	385
Copper hammer	221
Copper O-ring assortment	720
Cordless Drill / Driver	260
Cordless Impact Driver	260
Correct fit insert	529
Crankshaft adjustment tool	335
Crankshaft alignment ruler	331
Crankshaft counterholder	322
Crankshaft Holding Tool	343
Creeper	690
Creeper for sitting or lying down	690
Crescent spanner set	30
Cutting blade	558
Cutting blade set	557
Cutting off plate cylinder	234
Cutting wheel	422
Cutting wire	560
Cylinder honing tool	364
DCT assembly and disassembly tool	419
Decorative strip wedges	568
Dent straightening bar set	584
Die holder	203
Die holder seat	512
Diesel bleeder pump	367
Diesel bleeder set with adapters	366
Diesel fuel filter socket	374
Diesel fuel filters removal set	375
Diesel pump adjusting tool	368
Diesel special tool set	286
Digital brake disc caliper	182
Digital caliper gauge	182
Digital Clamp Multimeters	607
Digital ignition timing gun	286
Digital infrared thermometer	284
Digital multimeter	606
Digital torque adapter	274
Dip stick	406

Dip stick Type A	417
Dipsticks	406
Disc brush	215
Document holder	653
Door bolt fitting tool	580
Door expander pad	577
Door handle dismantling tool	581
Door hinge assembly set	580
Door lining loosener	579
Door lining loosener set	579
Door lock tool	581
Double open-ended spanner	7
Double open-ended spanner set	6
Double suction cup	561
Double suction cup set	561
Double-hook tool	357
Double-ring ratchet spanner set	29
Double-ring ratchet wrench	29
Double-ring spanner	18
Double-ring spanner set	18
Drawer partition	654
Drift punch	227
Drip pan	389
Drive shaft ejector	485
Drive shaft pull out tool set	486
Drive shaft pulling hammer	484
Drive shaft set	485
Drive-on ramp for passenger cars	689
Drive-on ramp for passenger cars	689
Drum Brake spring pliers	178
Dryer cartridge cap remover	432
E-circlip set	727
Ear hose clamp assortment	370
Ear protection	702
Easy-Heater	261
Edge protection	653
Electro soldering gun	592
Electronic stethoscope	287
Electronics long-nosed pliers	168
Electronics side-cutting pliers	168
Electronics taper tap	168
Emergency car-opener set	577
Empty box	728
Engine adjustment tool set	326
Engine alignment support bar	290
Engine bridge	290
Engine Compartment Light	677
Engine stand	290
Engine support bar	293
Engine support bar	291
Ergo combination pliers	161
Exhaust chain pipe cutter	423
Exhaust pipe expander	423
Exhaust spring compressor	423
Expulsion bolt	581
Extension	40
Extension Kit for Glow Pencils	311
Extension plate	683
Extension set	51
Fan hub spanner	382
Fan hub spanner set	381

Fast charging device for replacement battery	261
Fault code reader	280
Feeler gauge	184
Fiat trim clip assortment	571
Filling can	388
Filling funnel	388
Filling nipple for tyre inflator	514
Filter removal key for diesel filters	374
Fine-knitted glove	703
Fine-knitted glove	704
Fine-knitted glove	704
Fir tree fixings assortment	569
Fitting hook	213
Fitting paste	425
Flap Disc	595
Flaring tool	548
Flat spring key	789
Flexible driver	136
Flexible magnetic base holder	183
Flywheel holder	323
Foam gun	231
Folding wooden yardstick	184
Ford trim clip assortment	573
Front protector	692
Fuel Hose Clip Loosening Pliers	173
Fuel injection pump tool	367
Fuel transmitter key	371
Full-metal socket spanner	149
Funnel set	388
Fuse ammeter	607
Garage lamp	677
Garage order folder	692
Garage screwdriver set	130
Gas-filled damper clamp	581
Gauge set for steering tie rods	493
Gearbox lifter	413
Generator bit set	325
Generator multi-purpose key	325
Glass fibre reinforced wheel hub cleaner	522
Glazing removal blade	559
Glazing removal set	558
Glazing removal tool set	558
Glow and spark plug tool set	306
Glow plug inserts	306
Glow plug pliers	173
Glow plug reamer	313
Glow plug removal tool	308
Glow plug repair tool kit	309
Glow plug socket cleaning set	312
Glow plug thread repair set	311
Glow plug tool set	308
Glow-plug socket spanner, PSG	306
Glued weight remover	518
Grease gun accessories set	230
Grease nipple assortment	727
Grinding tool set	218
Gripping pliers set	158
Groove nut key	449
Guide bolt repair set	533
Guide tube tip	787
Half-shell set	791

Half-shell set supplement	791	IMPACT pin wrench	790	LED telescope inspection mirror	679
Hammer assortment	219	IMPACT screwdriver bit	77	LED telescopic torch	678
Hammer handle	220	IMPACT screwdriver bit, internal hex profile	92	LED tweezers product range	680
Hammer wedge	220	IMPACT screwdriver bits	76	LED-battery head lamp display-box	679
Hammer wedges	220	IMPACT socket	361	Left-hand drill set	189
Hand brush	216	IMPACT socket spanner bit	67	Lever ratchet handle	94
Hand tap	512	IMPACT spanner socket	93	Lever-force side-cutting pliers	162
Hand tap set	201	IMPACT spanner sockets	67	Line connector loosening clip set	371
Hand-held impact wrench set	152	IMPACT special bit set	88	Lock-ring drive-in set	735
Hand-lever grease press	229	IMPACT special spanner socket	419	Locking cylinder installation aid	581
Handle	39	IMPACT-duty adaptor and ball joint set	105	Locking pin	93
Hardmetal burrs	197	IMPACT-Duty ball joint sockets	67	Locking pliers	165
Heat protection cover	590	Industrial plug	710	Locking ring	93
Heavy duty filter loosening key	400	Industrial screwdriver set	49	Locking tool	327
Heavy-duty side-cutting pliers	162	Industrial socket	710	Locking tool set	330
High-pressure pump pull-off device	367	Industrial socket spanner set	71	Locksmith's hammer	218
Hinge tool	580	Industrial socket spanner set	36	Locksmith's hammer set	218
Hinge tool set	580	Industry-standard file	217	Magnet adaptor set	106
Hinged extension	41	Injection nozzle extractor	374	Magnetic and servicing mirror set	680
Hinged extension set	40	Injector / injector nozzle extraction tool set	296	Magnetic lifter	681
Hinged extensions	103	Injector / Injector-extraction tool set	299	Magnetic stand for tyre station	114
Hole and edge setter	593	Injector adapter set	282	Marking punch set	223
Hole cutter	197	Injector cleaner	305	Masonry breaching drill set	194
Hole saw	600	Injector extraction fork	303	Mazda trim clip assortment	572
Hollow pin/assortment of synchroniser rings	723	Injector extraction tool set	296	Measuring cable set	608
Honda trim clip assortment	571	Injector gasket puller	304	Mechanic's glove	704
Honing segments	364	Injector quantity tester	282	Mechanical flaring tool for SAE- and DIN-flaring	547
Hook set	212	Injector remover	302	Mechanical hydraulic cylinder	297
Hook spanner	501	Injector seat cleaning set	305	Mercedes-Benz mounting clip assortment	574
Hook tool	424	Injector socket spanner set	300	Metal funnel	388
Hose clamp set	372	Injectors seal seat-cutter set	305	Metal saw	187
Hose clamp set	724	Inlays for socket wrench applications	656	Metal sawblade	188
Hose clamp set	370	Inner bearing puller set	233	Metal sawblades	187
Hose clamp tool	135	Installation and dismantling set for rotary shaft seals	356	Mini bit ratchet	113
Hose cutter	186	Installation hook and Tang break tool	207	Mini grease gun including grease bag	228
Hose for compressed air	255	Jack stand	505	Mini hook set	212
Hose pump	373	Jack stand	505	Mini-screwdriver	140
Hose strap mounting device	489	Jackknife	186	Mitsubishi trim clip assortment	573
Hot air blower	267	Japanese spatula set	587	Module composition	657
Hot melt glue gun	267	Jointed heavy-duty handle	63	Mole wrench	546
Hot stapler plastic repair kit	567	Jointed hook spanner	501	Motorbike wheel clamp holder	737
Household saw	187	Jointed sockets	42	Mounting kit for parking sensors	567
Hub cap / axle nut wrench	785	Jointed sockets	103	Mounting lever for diesel fuel fitter	374
Hydraulic cylinder	297	Jumper cable	614	Mounting wedge set	568
Hydraulic cylinder 20 t	298	Key file set	217	'Multibag XL' tool bag	672
Hydraulic flaring tool	548	Knee pad	691	'Multibag XL' tool bag with 'UNIVERSAL' tooling	668
Hydraulic foot-operated pump	441	Knife set with break-off blades	185	Multi-purpose frame	567
Hydraulic jack	505	Knife with break-off blade	185	Multi-purpose glove	705
Hydraulic mouthpiece	230	Lambda probe loosening tool	301	Multi-purpose pump	373
Hydraulic spindle	233	Lambda probe thread repair insert	428	Multi-socket spanner bit	55
Hydro bearing tool	465	Lambda probe thread repair set	428	Multi-Tape counter display	381
Ignition coil fitting handles	315	Langbeck Locking pliers	166	Multitester	607
Ignition module removal set	314	Lashing strap	709	Nail puller	222
Ignition timing and TDC finder adjustment set	733	LED battery head lamp 2W COB	678	Needle and hook set	619
IMPACT adapter	41	LED electric torch	678	Needle scaler attachment	248
IMPACT adaptor set	104	LED extension	64	Nippers	163
IMPACT ball joint	51	LED head lamp	679	Nissan trim clip assortment	572
IMPACT ball joint bit	57	LED light pen	678	Nitrile glove	705
IMPACT brake calliper socket	532	LED magnetic lifter and mirror set	679	Non-recoil hammer	222
IMPACT cardan joint	65	LED mini flashlight	678		
IMPACT extension	64				



# Alphabetical Index

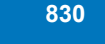

Nose pliers	163
Nose pliers set	158
Nozzle Adjusting Tool for Opel	565
Nozzle expulsion tool	303
Nut assortment	725
Nut splitter	211
Nylon oil filter strap wrench	401
O-ring assortment	722
Offset wrench	143
Oil collecting canister	395
Oil drain plug cutter	394
Oil draining adaptor	393
Oil draining screw repair set	394
Oil filler	415
Oil filling adapter	397
Oil filling funnel	397
Oil filling hose	414
Oil filter bell set	402
Oil filter cartridge inserts	402
Oil filter chain key	401
Oil filter cover	403
Oil filter cover set	403
Oil filter key	399
Oil filter pliers	402
Oil filter strap key	401
Oil pressure tester	284
Oil pump	404
Oil service insert-bit socket	393
Oil service key set	394
Oil servicing key	393
One-hand water pump plier	159
Open ring spanners	30
Open socket spanner set	499
Open-ended ring spanner	31
Open-ended slogging wrench	25
Open-ended spanner insert	273
Outside micrometer	183
Overvoltage protection	590
Padded pliers set	172
Paint layer gauge	556
Painter's spatula	214
Painting gun for compressed air	250
Pair of handles	559
Pair of spare cheeks	170
Panel beating hammer	221
Panel-beating pad set	585
Panel-beating tool set	584
Paper holder	653
Parting awl	560
Passenger car tow bar	709
Passenger car tow rope	708
Peg	335
Permanent magnet	142
Petrol pressure tester	283
Peugeot/ Citroën trim clip assortment	570
Pin and groove nut set	380
Pin punch	225
Pin punch set	226
Pin wrench	498
Pin wrench set	498
Pin-type Allen key	144

Pincers	680
Pinch off pliers	372
Pipe and hose cutter	186
Pipe cutter	549
Pipe head spanner	25
Pipe wrench	164
Pipe wrench	542
Pipe wrench set	156
Pipe wrench set	156
Piston compressor	240
Placement shell set	655
Placement shell set with foamed material inserts for cans	693
Plastic hammer	221
Plastic locking nut assortment	575
Plastic protective strip set	558
Plastic rivet gun set	167
Plastic rivets assortment	569
Plastic scraper set	518
Plastic spare heads	584
Plate bending and edging pliers	176
Pliers set	156
Pneumatic angle grinder	247
Pneumatic axial grinder	246
Pneumatic axial grinder set	246
Pneumatic axle bellows spreader	487
Pneumatic beating hammer	249
Pneumatic chipping hammer	247
Pneumatic glazing remover	249
Pneumatic grease gun	229
Pneumatic helical hose	255
Pneumatic hole and edge setting tool	249
Pneumatic impact screwdriver	241
Pneumatic oil filter removal aid	252
Pneumatic painting gun	250
Pneumatic pump	251
Pneumatic ratchet screwdriver	244
Pneumatic ratchet screwdriver set	244
Pneumatic sandblasting gun	252
Pneumatic sandblasting gun	252
Pneumatic spindle	539
Pneumatic spot weld cutter	249
Pneumatic spring strut compressor	493
Pneumatic tyre filler	513
Pocket gas burner	591
Polarity tester	319
Pole terminal remover	613
Pole wheel remover set	732
Popular drive (push-pin) rivet assortment	720
Pouring nozzle	389
Power bit	119
Power combined pliers	161
Power impact driver	63
Power socket set	87
Practi-hook	446
Precision gauge	183
Precision mechanic's tool set	156
Pressing clamp	441
Pressure loss tester	281
Pressure pad	440
Pressure pad set	417

Pressure regulator	253
Pressure ring	455
Pressure Sprayer	521
Probe	609
Professional roll-up bag for bikes	110
Professional saw	187
Professional saw	187
Professional scraper	214
Professional workshop cart	629
Propeller shaft separating tool	486
Protective goggles	590
Pry bar set	445
Punch set	224
Puncture probe set	609
Push-out attachment	446
Push-through ratchet	63
Quality scraper	213
Quality scraper set	214
Quick-action connector set	727
Quick-release chuck	195
Rabitz pliers	164
Radiator grille removal aid	326
Radiator removal tool case	384
Range of thread and tap drills, M4 – M10	188
Ratchet clamping strap	709
Ratchet ring spanner set	29
Ratchet wrench	37
Ratchet wrench set	110
Ratchet-type pipe cutter	423
Reamer	526
Reaming tool set	209
Reciprocating saw blade	188
Refill set	543
Refilling pump	372
Refractometer	286
Reinforced hose	230
Removal hooks for rear lamps	579
Remover set	231
Remover, universal	231
Renault trim clip assortment	570
Repair sleeves	207
Replacement battery	260
Replacement break-off blades	186
Replacement pump	385
Replacement spindle	550
Replacement square for push-through ratchet	86
Replug screwdriver set	141
Retainer for balance shafts	344
Retaining plate	335
Reversible ratchet insert	272
Ring ratchet spanner set	26
Ring wrench insert	273
Rivet header	228
Rivet setter	227
Roll-up bag for passenger car tools	671
Roll-up bag for tools	673
Rotary angle measuring device	276
Rotary angle measuring disc	275
Roughing disc	595
Round threading die	203
Rubber blow-out pin	246



Rubber hammer	221	SAUER Pressure and Support Sleeve Set, ø 30–68 mm	437	Sliding block	63
Rubber support disc	595	SAUER Pressure and Support Sleeve Set, ø 30–90 mm	438	Sliding handle	40
S-type double-ring spanner set	30	SAUER Pressure and Support Sleeve Set, ø 72–108 mm	437	Slugging ring wrench	24
SAC coupling tool set	418	SAUER Pressure Mandrel, 100 mm	807	Snap ring assortment	723
Safety knife	186	SAUER Pressure Mandrel, 25 mm	807	Socket adapter	115
Safety padlock	710	SAUER Pressure Spindle and Feed Shaft TR20 × 2.0 × 450 mm	813	Socket adaptor	114
Safety padlock	710	SAUER Pressure Spindle, 450 mm	813	Socket spanner bit	42
Safety pliers set	487	SAUER Socket Adapter for Pressure Pieces	813	Socket spanner bit, double hex	91
Safety screwdriver set	140	SAUER Thread Adapter Set for Hydraulic Cylinders and Press Frames	818	Socket spanner insert	425
Safety tongs for exhaust clamps	176	SAUER Uni-Heat U1230	262	Socket spanner insert	408
Sanding block	587	SAUER Uni-Heat U3230	262	Socket spanner oil drain plug VAG	393
SAUER Aluminium Hydraulic Cylinder, 20 t	806	Saw blade for bodywork	596	Socket spanner set	42
SAUER Aluminium Hydraulic Foot Pump, 700 bar	441	Scissor-type jointed pliers, extra-long	163	Sockets with ball head	46
SAUER Basic Set with Press Frame	436	Scissors-type jack	504	Solder fixing pliers	618
SAUER Bearing Adapter	810	Scraper and hook set	212	Soldering fluid	592
SAUER Connector Rod for Press Frame, 200 mm	811	Scraper set	214	Soldering grease	592
SAUER Connector Rod Pair for Press Frame, 200 mm	811	Screw clamp	228	Soldering iron	592
SAUER Cylinder Adapter	812	Screw extractor set	211	Soldering tin	592
SAUER Cylinder Holder	801	Screw rivet trim fixing assortment	575	Soldering wire	592
SAUER Drive Set for Manual Tensioning and Pressing	802	Screw set	126	Spanner assortment	30
SAUER Drive Set, Hydraulic	436	Screw with aluminium seal	395	Spanner for tamperproof hardware	324
SAUER Drive Set, manual	438	Screwdriver	134	Spanner for tamperproof hardware set	325
SAUER Feed Shaft M10 × 450 mm	812	Screwdriver bit	115	Spare guide pin	533
SAUER Feed Shaft M10 × 450 mm with Nut	812	Screwdriver bit	44	Spare hose	513
SAUER Feed Shaft TR10 × 1.5 × 350 mm	809	Screwdriver bit	80	Spark plug brush	216
SAUER Hydraulic Adapter Set for Hydraulic Cylinders and Hydraulic Pumps	818	Screwdriver bits	43	Spark plug connector pliers	173
SAUER Internal Bearing Ring Removal Set, ø 40–61 mm	477	Screwdriver bits sockets with ball head	46	Spark plug key	317
SAUER Maxi-Heat X11380	264	Screwdriver bits sockets with ball head	46	Spark plug removal set	314
SAUER Maxi-Heat X16380	265	Screwdriver impact-proof	137	Spark plug socket	315
SAUER Maxi-Heat X4230	263	Screwdriver set	131	Spark plug thread repair tool set	318
SAUER Maxi-Heat X5230	263	Screwdriver set, Impact proofed	136	Spark plug tool set	317
SAUER Maxi-Heat X5380	264	Seal scraper set	213	Special 8-in-1 spanner for oil pans	393
SAUER Nut M10 × 1.5	812	Sealing ring fitting set	363	Special adapter for screwdriver bits	114
SAUER Nut TR10 × 1.5	810	Sealing stopper set	371	Special adhesive sticks	585
SAUER Nut TR20×2.0	813	Sealing stopper set	371	Special bit assortment	61
SAUER Plastic Case	804	Separating and mounting fork	443	Special bits	55
SAUER Plastic Welder PW320	267	Separating and mounting fork set	443	Special brake calliper brush	529
SAUER Press Frame, Closed Design	810	Set of double hook	656	Special brake calliper brush set	529
SAUER Press Frame, Open Design	811	Set of fitting washers	475	Special brake calliper file	530
SAUER Pressing Clamp Holder	811	Set of fitting washers	475	Special detaching pliers	579
SAUER Pressing Clamp Set	438	Set of single hooks	656	Special door spring pliers	579
SAUER Pressure and Support Sleeve ø 18/26 mm × 40 mm	816	Setting tool for injection pumps	368	Special drill	395
SAUER Pressure and Support Sleeve ø 26/34 mm × 100 mm	817	Shaft seal assembly tool set	356	Special grip set	158
SAUER Pressure and Support Sleeve Set	801	Shaft sealing ring pull-out set	357	Special groove nut wrench	328
SAUER Pressure and Support Sleeve Set, Hydraulic	800	Shaft sealing ring removal set	357	Special insert	54
SAUER Pressure and Support Sleeve Set, Manual	801	Shear rivet tool	166	Special insert set	476
SAUER Pressure and Support Sleeve Set, ø 102–120 mm	437	Shears	187	Special locking pliers	601
SAUER Pressure and Support Sleeve Set, ø 18–78 mm	436	Shock absorber fitting tool set	498	Special rotational handle angled screwdriver set	736
SAUER Pressure and Support Sleeve Set, ø 22–60 mm	437	Shock absorber tool set	499	Special scraper set	213
SAUER Pressure and Support Sleeve Set, ø 22–82 mm	437	Shock absorber wrench	498	Special screwdriver bit	484
		Shrinking hose assortment	721	Special screwdriver bit set	303
		Side-cutting pliers	161	Special screwdriver bits	105
		Silent bearing tool	366	Special screwing system	105
		Silent bearing tool	805	Special socket	531
		Silent bearing/supporting joint tool set	439	Special spanner	375
		Single tooth thread tap	202	Special spanner socket	294
		Single-handed grease gun	229	Special spark plug connector removal tool	314
		Sledgehammer	220	Special spark plug key	315
				Special steering head bearing removal set	735
				Special T-handle socket spanner	581



# Alphabetical Index



Special tool set for motorbikes	732
Spider wrench	506
Spindle	440
Spiral drill bit	194
Spiral drill bit set	193
Spiral drill set	188
Spiral groove socket	509
Spiral groove sockets	58
Spoke wrench	736
Spot welding locking pliers	166
Spreading sleeve	233
Spreading tool	499
Spriral groove sockets	509
Spring clamp pliers	174
Spring clip pliers	174
Spring loaded brake caliper piston windback tool	538
Spring retainer	494
Spring tensioning set	494
Square drive insert	272
Squeeze out pliers	176
Steel stamping letters	223
Steel stamping numbers	224
Steering knuckle joint tool	491
Steering wheel sleeve remover	566
Steering wheel spirit level	493
Stool on wheels	690
Storage compartment	655
Straight edge	357
Straightening set	584
Stripe off wheel	518
Stripping pliers	168
Stub axle lifter	445
Stud bolt extractor	210
Stud bolt extractor set	209
Stud bolt extractors	209
Stud bolt thread repair kit	205
Stud extractor	210
Suction pump	405
Supplementary set	478
Supplementary set compact bearings	481
Supporting joint tool	447
SW-Stahl High performance grease	228
SW-Stahl Multi-Tape, black	381
SW-Stahl poloshirt	701
SW-Stahl softshell jacket	700
SW-Stahl softshell sleeveless jacket	700
SW-Stahl sweatshirt	701
SW-Stahl t-shirt	700
SW-Stahl trousers	701
Swingarm pivot tool set	735
Synchronous carburetor tester	283
T-handle hex socket wrench	148
T-handle pin wrench assortment	150
T-handle pin wrench assortment	150
T-handle screwdriver	40
T-handle screwdriver set	148
Tap and spiral drill bit set	204
Tap bit	204
Tap bit set	204
Tap extension	200

Tap seat	512
Tap wrench	200
Tape measure	184
TCT marker	227
Telephone pliers	162
Telescop ratchet wrench	62
Telescopic inspection mirror	679
Telescopic magnetic lifter	681
Telescopic screwdriver	135
Telescopic spring tensioner	496
Telescopic support for bonnet	582
Tension / thrust sleeve set	440
Tensioner key	336
Test cable connector	609
Test cable socket	608
Test nozzle	386
Tester for diesel injector sockets	282
Testing lamp	319
Thread cutting tool set	198
Thread file	208
Thread gauge	200
Thread repair set	205
Thread repair toolkit	309
Thread tap set	198
Thread tapping set	208
Threaded bolt set	487
Threading die adapter set	198
Through-bolt socket spanner set	101
Tie rod tool	490
Timing chain tool	338
Tip	191
Tool and device strip	693
Tool assortment	669
Tool case	103
Tool for loosening wheel nut caps	511
Tool holder	201
Tool set	446
Toothed belt measuring tool	355
Toothed-belt tension tester	335
Torque reproducer	276
Torque screwdriver	275
Torque screwdriver	275
Torque wrench	273
Torque Wrench	270
Torque wrench for V-ribbed belt	321
Toyota/Lexus trim clip assortment	576
Trapezoidal blades	708
Triangular hollow scraper	214
Trolley Jack	504
Truck servicing bag	671
Truck silent bearing set	790
Truck wheel transporting device	523
Turbo system force-off set	407
Twist drill	196
Twist drill set	196
Twist grip ratchet	39
Tyre air pressure tester	514
Tyre bag	521
Tyre iron	519
Tyre pressure sensor tool set	514
Tyre pressure sensor tool set	515

Tyre profile depth gauge	517
Tyre profile gauge	517
Tyre removal and fitting lever	519
Tyre valve removal tool	515
Tyre valve stem fitting tool	516
Universal axle bellows set	488
Universal balance weight pliers	177
Universal brake caliper piston windback adapter plates	538
Universal brake caliper piston windback cube	534
Universal brake caliper piston windback tool kit	535
Universal brake piston press tool	534
Universal Camshaft Pulley Puller	355
Universal clutch and rotor holder	733
Universal lashing box	709
Universal mounting clip assortment	575
Universal pliers	161
Universal reamer set for ABS sensors	526
Universal scissors	186
Universal seat cushion protector	692
Universal socket	46
Universal stethoscope	286
Universal tank sensor key	375
Unlocking tool set	618
V-rib belt tool set	324
V-rip belt clamping key set	323
Vacuum brake bleeder	543
Vacuum pump	373
Valve gauge	183
Valve grinder	359
Valve inserting tool	515
Valve inserting tool set	515
Valve lathe tool for steel valves	516
Valve mounting pliers	516
Valve sealing ring pliers	173
Valve seat milling cutter set	360
Valve spring fitting set	358
Valve spring tensioner	359
Valve spring tensioning unit	358
Valve spring tool set	734
Valve tool set	515
Vauxhall/Opel trim clip assortment	570
Vehicle window assembly frame	560
Vibration pneumatic impact screwdriver	241
Vibro pneumatic chisel set	247
Vice	495
Voltage tester	609
Volvo trim clip assortment	569
VW mounting clip assortment	574
VW/Audi fitting tool	362
W-clip assortment	723
Wad punch	225
Wad punch set	224
Washer assortment	726
Waste air hose	254
Water pump pliers	158
Water pump tool set	383
Weld spot cutter	195
Weld spot cutter set	597
Weld spot drill	195



Welder's protective visor	591
Welding helmet	591
Wheel alignment wrench	490
Wheel bearing pressure piece set	476
Wheel bearing removal tool	794
Wheel bearing set	480
Wheel bearing tool	476
Wheel bearing tool set	476
Wheel hub cleaner set	522
Wheel hub grinder replacement cleaning discs	523
Wheel hub grinder replacement cleaning discs	522
Wheel hub removal tool	481
Wheel hub removal tool set	482
Wheel lock nut set BMW	510
Wheel lock nut set Mercedes-Benz	510
Wheel lock nut set VW	510
Wheel lock removal tool	509
Wheel nut key	505
Wheel nut socket	507
Wheel nut sockets	507
Winding drum for compressed air hose	256
Window	591
Windscreen stand	556
Windscreen wiper arm remover	563
Wing protector	691
Wiper removal set	565
Wire guiding probe	559
Wire steady	560
Wishbone lever tool	445
Work glove	704
Workbench	697
Workshop cart assortment XL	627
Workshop cart assortment XXL	627
Workshop crane	290
Workshop files	217
Workshop mobile tool chest - RX-Edition	624
Workshop mobile tool chest assortment	628
Workshop mobile tool chest XL - RX-Edition	624
Workshop mobile tool chest XXL - RX-Edition	625
Workshop press	475
Workshop screwdriver	130
XZN tripe square insert	77
4-leg tripod	677



# Part no. Index



Part no.	Page	Part no.	Page	Part no.	Page	Part no.	Page
00101L	7	00170L	18	00264L	24	00815SB	11
00101SB	8	00180L	20	00265L	24	00816L	10
00102L	7	00181L	21	00266L	24	00816SB	11
00102SB	8	00192L	15	00267L	24	00817L	10
00103L	7	00193L	15	00269L	24	00817SB	11
00103SB	8	00203L	16	00270L	24	00818L	10
00104L	7	00203SB	17	00271L	24	00818SB	11
00104SB	8	00204L	16	00272L	24	00819L	10
00106L	7	00204SB	17	00273L	24	00819SB	11
00106SB	8	00205L	16	00274L	24	00820L	10
00108L	7	00205SB	17	00275L	24	00820SB	11
00108SB	8	00206L	16	00276L	24	00821L	10
00109L	7	00206SB	17	00279L	24	00821SB	11
00109SB	8	00207L	16	00280L	25	00822L	10
00110L	7	00207SB	17	00281L	25	00822SB	11
00110SB	8	00208L	16	00285L	25	00824L	10
00112L	7	00208SB	17	00287L	25	00824SB	11
00112SB	8	00209L	16	00288L	25	00825L	10
00113L	7	00209SB	17	00289L	25	00825SB	11
00113SB	8	00210L	16	00290L	25	00826L	10
00114L	7	00210SB	17	00291L	25	00827L	10
00114SB	8	00211L	16	00292L	25	00828L	10
00115L	7	00211SB	17	00293L	25	00829L	10
00115SB	8	00212L	16	00294L	25	00830L	12
00116L	7	00212SB	17	00295L	25	00830L-10	13
00116SB	8	00213L	16	00296L	25	00830L-11	13
00117L	7	00213SB	17	00297L	25	00830L-12	13
00118L	7	00214L	16	00298L	25	00830L-13	13
00120SB	381	00214SB	17	00299L	25	00830L-14	13
00123L	382	00215L	16	00312L	8	00830L-15	13
00124L	382	00215SB	17	00712L	32	00830L-16	13
00125L	382	00216L	16	00801L	10	00830L-17	13
00126L	382	00216SB	17	00801SB	11	00830L-18	13
00130L	7	00217L	16	00802L	10	00830L-19	13
00130SB	8	00217SB	17	00802SB	11	00830L-6	13
00131L	7	00218L	16	00803L	10	00830L-7	13
00131SB	8	00218SB	17	00803SB	11	00830L-8	13
00133L	7	00219L	16	00804L	10	00830L-9	13
00133SB	8	00219SB	17	00804SB	11	00831L	10
00137L	7	00220L	16	00805L	10	00832L	10
00137SB	8	00220SB	17	00805SB	11	00835L	12
00139L	7	00221L	16	00806L	10	00835L-21	13
00139SB	8	00221SB	17	00806SB	11	00835L-22	13
00140L	7	00222L	16	00807L	10	00835L-24	13
00140SB	8	00222SB	17	00807SB	11	00835L-27	13
00141L	7	00223L	16	00808L	10	00835L-30	13
00141SB	8	00223SB	17	00808SB	11	00835L-32	13
00142L	7	00224L	16	00809L	10	00840L	12
00142SB	8	00224SB	17	00809SB	11	00908L	14
00143L	7	00225L	16	00810L	10	00912L	14
00143SB	8	00225SB	17	00810SB	11	00919L	14
00144L	7	00226L	16	00811L	10	00922L	14
00145L	7	00226SB	17	00811SB	11	00925L	14
00146L	7	00227L	16	00812L	10	00927L	13
00147L	7	00227SB	17	00812SB	11	00927L-34	13
00150L	6	00228L	16	00813L	10	00927L-36	13
00151L	6	00228SB	17	00813SB	11	00927L-38	13
00162L	9	00257L	24	00814L	10	00927L-41	13
00163L	9	00258L	24	00814SB	11	00927L-46	13
00166L	12	00262L	24	00815L	10	00927L-50	13

Part no.	Page	Part no.	Page	Part no.	Page	Part no.	Page
00927L-55	13	01313SB	19	01445L-KOFFER	536	01480L-13	31
00935L	30	01314L	18	01446L	550	01480L-14	31
00941L	24	01314SB	19	01448L	532	01480L-15	31
00942L	24	01315L	18	01449L	539	01480L-16	31
00943L	24	01315SB	19	01450SB	546	01480L-17	31
00944L	24	01316L	18	01455L	539	01480L-18	31
00945L	24	01316SB	19	01461L	538	01480L-19	31
00946L	24	01317L	18	01462L	538	01482L	55
01-110-WB	8	01317SB	19	01463L	534	01488L	375
01-121-WB	14	01351L	19	01464L	534	01488L-2	376
01-122-WB	14	01352L	19	01465L	536	01488L-3	376
01-141-WB	23	01353L	19	01465L-0	537	01490L	31
01201L	22	01354L	19	01465L-2	537	01490L-20	31
01201SB	23	01355L	19	01465L-3	537	01490L-21	31
01202L	22	01356L	19	01465L-4	537	01490L-22	31
01202SB	23	01357L	19	01465L-7	537	01490L-23	31
01204L	22	01400SB	546	01465L-8	537	01490L-24	31
01204SB	23	01401SB	546	01465L-9	537	01490L-25	31
01207L	22	01402SB	546	01465L-A	537	01490L-26	31
01207SB	23	01405SB	547	01465L-KOFFER	536	01490L-27	31
01210L	22	01406L	541	01465L-M	537	01490L-28	31
01210SB	23	01411L	531	01465L-N	537	01490L-30	31
01212L	22	01412L	531	01466L	535	01490L-32	31
01212SB	23	01413L	531	01467L	538	01490L-KOFFER	31
01213L	22	01415L	376	01467L-0D	537	01495L-33	31
01213SB	23	01415L-1	376	01467L-11	537	01495L-38	31
01214L	22	01415L-2	376	01467L-12	537	01495L-41	31
01214SB	23	01415L-3	376	01467L-A	537	01495L-46	31
01215L	22	01415L-4	376	01467L-B	537	01495L-50	31
01215SB	23	01415L-5	376	01467L-C	537	01497L	545
01216L	22	01415L-6	376	01467L-D	537	01498L	544
01216SB	23	01420L	543	01467L-E	537	01499L	544
01218L	22	01421L	546	01467L-F	537	01508L	23
01218SB	23	01422L	543	01467L-G1	537	01512L	23
01221L	22	01423L	543	01467L-J	537	01550L	19
01221SB	23	01424L	373	01467L-K	537	01551L	20
01222L	22	01425L	373	01467L-K1	537	01552L	20
01222SB	23	01426L	543	01467L-K2	537	01553L	20
01223L	22	01427L	543	01467L-P	537	01554L	20
01224L	22	01429L	542	01467L-Q	537	01556L	20
01225L	22	01431L	537	01467L-R	537	01560L	19
01226L	22	01432L	535	01467L-S	537	01580L	24
01227L	22	01433L	534	01467L-T	537	01905L	30
01301L	18	01434L	534	01467L-V	537	01910L	30
01301SB	19	01435L	535	01467L-W	537	02000L	515
01302L	18	01435L-1	535	01470L	533	02010L	150
01302SB	19	01435L-2	537	01471L	533	02011L	150
01304L	18	01435L-3	535	01472L	533	02012L	150
01304SB	19	01435L-5	535	01475L	541	02013L	150
01305L	18	01435L-6	535	01476L	178	02014L	150
01305SB	19	01435L-E	535	01477L	533	02015L	150
01308L	18	01435L-K	535	01477L-1	533	02016L	150
01308SB	19	01436L	534	01477L-2	533	02020L	150
01310L	18	01437L	533	01477L-3	533	02025L	515
01310SB	19	01438L	532	01478L	533	02030L	149
01311L	18	01441L	532	01479L	544	02031L	149
01311SB	19	01442L	550	01480L	30	02032L	149
01312L	18	01443L	550	01480L-10	31	02034L	149
01312SB	19	01444L	531	01480L-11	31	02035L	149
01313L	18	01445L	536	01480L-12	31	02036L	149



# Part no. Index



Part no.	Page	Part no.	Page	Part no.	Page	Part no.	Page
02040L	582	02160L	519	03029L	395	03685L	308
02045L	515	02161L	520	03030L	395	03686L	302
02050L	148	02162L	519	03031L	395	03688L	300
02051L	148	02163L	520	03032L	394	03689L	304
02053L	148	02200L	506	03033L	395	03690L	311
02055L	148	02210L	506	03034L	395	03691L	311
02063L	148	02220L	506	03035L	395	03692L	311
02066L	136	02222L	506	03040L	394	03693L	311
02067L	136	02226L	506	03101SB	315	03694L	303
02068L	136	02242L	505	03102SB	315	03695L	305
02076L	135	02245L	505	03103SB	315	03696L	313
02077L	135	02247L	505	03105SB	315	03697L	305
02078L	135	02251L	505	03110L	306	03700L	309
02080-10X230	148	02305SB	511	03120L	306	03701L	309
02080-11X230	148	02370L	208	03146L	316	03702L	309
02080-12X230	148	02370L-1	512	03149L	316	03703L	309
02080-13X230	148	02370L-2	512	03150SB	315	03704L	310
02080-14X230	148	02370L-3	512	03155SB	315	03705L	310
02080-6X230	148	02370L-4	512	03160SB	315	03706L	309
02080-7X230	148	02370L-5	512	03165SB	315	03707L	310
02080-8X230	148	02370L-6	512	03410L	29	03708L	310
02080-9X230	148	02370L-7	512	03415L	29	03709L	310
02083L	135	02370L-8	512	03601SB	317	03710SB	317
02084L	135	02370L-9	512	03602SB	317	03711L	311
02085L-10	149	02371L	205	03603L	317	03712L	311
02085L-12	149	02380-18	509	03605L	315	03713L	311
02085L-13	149	02380-19	509	03610L	317	03714L	312
02085L-6	149	02380-20	509	03620L	317	03715L	312
02085L-8	149	02380-21	509	03630L	316	03716L	312
02086L	40	02380-22	509	03631L	316	03717L	311
02087L	135	02380-23	509	03632L	316	03718L	305
02090L	136	02380-24	509	03640L	316	03807L	272
02091L	135	02380-25	509	03641L	316	03808L	272
02095L	136	02380L	509	03642L	306	03809L	271
02100L	506	02381L	510	03644L	306	03810L	271
02102L	506	02382L	510	03645L	306	03810L-REP	271
02105SB	506	02383L	511	03646L	306	03811L	270
02109L	736	02384L	511	03647L	306	03811L-REP	270
02110L	515	02385L	510	03648L	306	03812L	270
02112L	516	02400L	507	03649L	306	03812L-REP	270
02115L	517	02450L	507	03650L	307	03813L	270
02116L	517	03000SB	393	03660L	308	03813L-REP	270
02117L	516	03002L	414	03661L	303	03814L	270
02118L	515	03003L	393	03662L	303	03814L-REP	270
02120L	515	03004L	406	03663L	303	03815L	270
02129L	514	03004L-A	406	03664L	304	03815L-REP	270
02130L	425	03005L	394	03666L	303	03816L	271
02132L	425	03006L	406	03666L-ADA	303	03816L-REP	271
02135L	520	03007L	393	03667L	302	03817L	271
02136L	521	03010L	394	03668L	312	03818L	271
02150L	519	03011L	395	03668L-1	313	03818L-REP	271
02151L	519	03012L	395	03668L-2	313	03819L	270
02152L	519	03013L	395	03668L-3	313	03821L	272
02153L	519	03015L	394	03668L-4	313	03822L	272
02154L	520	03016L	393	03669L	308	03830L	272
02155L	519	03020L	394	03671L	309	03831L	272
02156L	519	03025L	395	03672L	309	03832L	272
02157L	520	03026L	395	03680L	303	03833L	273
02158L	520	03027L	395	03683L	305	03834L	273
02159L	520	03028L	394	03684L	304	03835L	273

Part no.	Page	Part no.	Page	Part no.	Page	Part no.	Page
03836L	273	04150BB2,6	209	04350SB	142	04426L	81
03837L	273	04150BB3,4	209	04360SB	145	04427L	81
03838L	273	04150BB5,1	209	04370SB	145	04428L	81
03839L	273	04150GB5,1	209	04380L	144	04429L	81
03841L	273	04150HGB3-1	209	04400L	580	04430L	43
03842L	273	04150HGB3-3	209	04401L	566	04435L	71
03844L	273	04150HGB4-1	209	04402L	581	04440L	126
03847L	273	04150HGB4-3	209	04403L	566	04442L	127
03853L	273	04150HGB6-1	209	04404L	581	04445L	126
03854L	273	04150HGB6-3	209	04405L	580	04450SB	146
03855L	273	04150L	209	04406L	581	04455L	147
03856L	273	04150L-1	209	04407L	580	04461L	55
03857L	273	04150L-2	209	04407L-1	580	04462L	45
03858L	273	04150L-3	209	04407L-2	580	04462-T10	46
03859L	273	04160L	209	04407L-3	580	04462-T15	46
03861L	273	04161L	210	04407L-4	580	04462-T20	46
03862L	273	04162L	210	04407L-5	580	04462-T25	46
03864L	273	04163L	210	04407L-6	580	04462-T27	46
03867L	273	04164L	210	04407L-7	580	04462-T30	46
03900L	274	04165FH6	209	04407L-8	580	04462-T40	46
03902L	274	04165FH8	209	04407L-9	580	04462-T8	46
03903L	275	04165KL	209	04408L	542	04470L	121
03904L	275	04165LL	209	04410SB	146	04475L	125
03904L-1	275	04166L	209	04415L	122	04480K10	125
03905L	274	04167L	210	04416SB	122	04480K15	125
03907L	275	04169L	209	04420L	123	04480K20	125
03910L	275	04180L	60	04421SB	123	04480K25	125
03915L	276	04186-ADAPTER	114	04422L	80	04480K27	125
03916L	276	04186L	127	04423L	82	04480K30	125
03920L	274	04186T10	120	04424L	77	04480K40	125
03921L	274	04186T15	120	04424L-XZN10L	77	04480K45	125
03928L	274	04186T20	120	04424L-XZN12L	77	04480K50	125
03933L	274	04186T25	120	04424L-XZN14	77	04480K55	125
03933L-REP	274	04186T27	120	04424L-XZN14L	77	04480L	124
03935L	273	04186T30	120	04424L-XZN5	77	04480L10	125
03940L-IMP	275	04186T40	120	04424L-XZN6	77	04480L15	125
03941L-IMP	275	04186T45	120	04424L-XZN8	77	04480L20	125
03942L-IMP	275	04186T50	120	04424L-XZN8L	77	04480L25	125
03942L-REP	275	04186T55	120	04424L-XZN9	77	04480L27	125
03955L	276	04186T60	120	04425K10	123	04480L30	125
03965L	276	04186T7	120	04425K11	123	04480L40	125
03966L	276	04186T70	120	04425K12	123	04480L45	125
04000L	401	04186-T8	120	04425K13	123	04480L50	125
04100L	152	04187L	49	04425K5	123	04480L55	125
04100L-K2	119	04191L	113	04425K6	123	04480L-KOFFER	124
04100L-K3	119	04205SB	145	04425K7	123	04484L	147
04100L-S10	119	04210SB	145	04425K8	123	04485SB	146
04100L-S8	119	04215SB	148	04425K9	123	04490L	126
04103L	152	04220SB	146	04425L	122	04490L-KOFFER	126
04104SB	135	04230L	146	04425L10	123	04490-T10	134
04112L	114	04230L-T10	147	04425L10,3	123	04490-T15	134
04113L	114	04230L-T15	147	04425L11	123	04490-T20	134
04126L	112	04230L-T20	147	04425L12	123	04490-T25	134
04127L	113	04230L-T25	147	04425L13	123	04490-T27	134
04128L	112	04230L-T27	147	04425L14	123	04490-T30	134
04130L	152	04230L-T30	147	04425L5	123	04490-T40	134
04140L	111	04230L-T40	147	04425L6	123	04490-T8	134
04141L	111	04230L-T45	147	04425L7	123	04494L	148
04142L	113	04230L-T50	147	04425L8	123	04495L	145
04145L	112	04310SB	142	04425L9	123	04500L	580



# Part no. Index



Part no.	Page
04500-SW8	580
04500-T40	580
04500-T45	580
04500-XZN10	580
04500-XZN8	580
04506L	25
04507L	25
04508L	25
04509L	25
04510L	25
04511L	25
04512L	25
04513L	25
04514L	25
04515L	25
04516L	25
04517L	25
04518L	25
04519L	25
04520L	25
04521L	25
04522L	25
04523L	25
04524L	25
04525L	25
04526L	25
04527L	25
04528L	25
04529L	25
04530L	25
04533L	80
04534L	80
04535L	80
04536L	80
04537L	80
04538L	81
04539L	81
04540L	81
04541L	81
04542L	81
04543L	81
04544L	81
04545L	81
04546L	81
04547L	81
04548L	81
04549L	81
04550L	81
04552L	92
04553L	92
04554L	92
04555L	92
04556L	92
04557L	92
04558L	92
04559L	92
04560L	92
04561L	80
04562L	80
04563L	80

Part no.	Page
04564L	80
04565L	81
04566L	81
04567L	81
04568L	81
04569L	81
04570L	81
04571L	81
04572L	81
04600L	105
04701L	143
04702L	143
04703L	143
04704L	143
04705L	143
04706L	143
04707L	143
04708L	143
04709L	143
04710L	143
04711L	143
04712L	143
04713L	143
04714L	143
04715L	143
04716L	143
04717L	143
04718L	143
04719L	143
04720L	143
04721L	143
04722L	143
04723L	143
04724L	143
04725L	143
04726L	143
04727L	143
04750L	144
04751L	144
04752L	144
04753L	144
04754L	144
04755L	144
04770L	531
04801L	144
04802L	144
04803L	144
04804L	144
04805L	144
04806L	144
04807L	144
04808L	144
04809L	144
04810L	144
04811L	144
04813L	144
04815L	144
04818L	144
04819L	144
04820L	144

Part no.	Page
04821L	144
04900L	61
04900L-INB7	61
04900L-TX55	61
04900L-TX70	61
04900L-XZN10	61
04900L-XZN12	61
04900L-XZN8	61
04920L	121
04922L	57
04923L	74
04950L	74
05000L	75
05001L	75
05002L	75
05003L	75
05004L	75
05005L	75
05006L	75
05007L	75
05010L	76
05010L-10	76
05010L-12	76
05010L-4	76
05010L-5	76
05010L-6	76
05010L-7	76
05010L-8	76
05011L	76
05012L	75
05013L	75
05014L	75
05015L	75
05016L	76
05017L	75
05018L	531
05019L	531
05020L	121
05021L	121
05022L	121
05023L	121
05024L	121
05025L	121
05026L	121
05035L	153
05036L	153
05037L	153
05038L	153
05040L	153
05041L	75
05042L	76
05043L	76
05044L	76
05045L	76
05046L	76
05047L	76
05048L	75
05049L	75
05101L	75
05102L	75

Part no.	Page
05103L	75
05104L	75
05105L	75
05106L	75
05107L	75
05108L	75
05109L	75
05110L	75
05111L	508
05112L	508
05113L	736
05114L	75
05115L	75
05120L	121
05121L	121
05122L	121
05123L	121
05124L	121
05125L	121
05126L	121
05200L	78
05201L	78
05202L	78
05203L	78
05204L	78
05205L	78
05207L	78
05208L	484
05209L	484
05210L	79
05211L	79
05212L	79
05213L	79
05214L	484
05215L	57
05216L	57
05218L	79
05220L	122
05221L	122
05222L	122
05223L	122
05224L	122
05227L	78
05228L	78
05230L	124
05231L	124
05232L	124
05233L	124
05234L	124
05235L	124
05236L	124
05237L	124
05238L	124
05239L	124
05241L	83
05242L	83
05243L	83
05244L	83
05245L	83
05246L	83



# Part no. Index



Part no.	Page	Part no.	Page	Part no.	Page	Part no.	Page
05615L	66	05641L	92	05716L-REP	39	05990L-REP	61
05616L	66	05643SB	92	05745L	113	05991L	62
05617L	66	05650L	73	05752L	41	05993L	63
05618L	66	05650L-10	73	05753L	41	05993L-KNARRE	63
05619L	66	05650L-11	73	05754L	41	05995L	61
05620L	66	05650L-12	73	05755L	41	05999L	61
05621L	66	05650L-13	73	05760SB	40	06420L	37
05625L	66	05650L-14	73	05790L	37	06447L	36
05626L	66	05650L-15	73	05790L-REP	37	06447L-KOFFER	36
05629L	114	05650L-16	73	05791L	39	06450-Handgriff	39
05630-10	68	05650L-17	73	05795L	38	06450-Knarre	38
05630-11	68	05650L-18	73	05799L	38	06450L	37
05630-12	68	05650L-19	73	05800SB	50	06450L-KOFFER	37
05630-13	68	05650L-20	73	05802L	50	06455L	36
05630-14	68	05650L-21	73	05803L	51	06455L-E10	43
05630-15	68	05650L-22	73	05804L	51	06455L-E11	43
05630-16	68	05650L-24	73	05805L	51	06455L-E12	43
05630-17	68	05650L-27	73	05806L	51	06455L-E13	43
05630-18	68	05650L-30	73	05820L	51	06455L-E14	43
05630-19	68	05650L-32	73	05851L	51	06455L-E4	43
05630-20	68	05650L-8	73	05852L	51	06455L-E4,5	43
05630-21	68	05650L-9	73	05853L	51	06455L-E5	43
05630-22	68	05655L	102	05855L	51	06455L-E5,5	43
05630-24	68	05660L	72	05856L	51	06455L-E6	43
05630L	68	05661L	72	05890L	49	06455L-E7	43
05632-10SB	70	05662L	72	05890L-REP	49	06455L-E8	43
05632-11SB	70	05663L	72	05891L	50	06455L-E9	43
05632-12SB	70	05664L	72	05895L	50	06520-INB10	57
05632-13SB	70	05665L	72	05899L	50	06520-INB3	57
05632-14SB	70	05666L	72	05900SB	62	06520-INB4	57
05632-15SB	70	05667L	72	05901L	62	06520-INB5	57
05632-16SB	70	05668L	72	05902SB	62	06520-INB6	57
05632-17SB	70	05670L	72	05903L	64	06520-INB7	57
05632-18SB	70	05671L	72	05904L	64	06520-INB8	57
05632-19SB	70	05672L	72	05905L	64	06520L	48
05632-21SB	70	05673L	72	05906L	64	06520-T15	58
05632-22SB	70	05674L	72	05907L	63	06520-T20	58
05632-24SB	70	05675L	72	05907L-1	63	06520-T25	58
05632L	70	05676L	72	05911L	63	06520-T27	58
05640-10	69	05677L	72	05911L-REP	63	06520-T30	58
05640-11	69	05678L	72	05912L	64	06520-T40	58
05640-12	69	05680L	72	05914L	62	06520-XZN10	57
05640-13	69	05682L	61	05916L	62	06520-XZN12	57
05640-14	69	05685L	72	05916L-REP	62	06520-XZN8	57
05640-15	69	05700SB	38	05917L	63	06521L	48
05640-16	69	05701L	38	05919L	63	06521L-KOFFER	48
05640-17	69	05702SB	39	05920L	63	06540L	499
05640-18	69	05703L	41	05950L	88	06600L	53
05640-19	69	05704L	40	05951L	64	06601L	53
05640-20	69	05705L	40	05952L	64	06602L	53
05640-21	69	05706L	40	05953L	64	06603L	53
05640-22	69	05707L	40	05954L	64	06604L	53
05640-24	69	05708L	41	05955L	64	06605L	53
05640-27	69	05709L	41	05958L	88	06606L	53
05640-30	69	05710SB	38	05958L-REP	88	06607L	53
05640-32	69	05712L	40	05959L	94	06608L	53
05640-36	69	05713L	40	05963L	94	06609L	53
05640-8	69	05714L	39	05970SB	64	06610L	103
05640-9	69	05715L	39	05985L	103	06611L	53
05640L	69	05716L	39	05990L	61	06620L	42



Part no.	Page	Part no.	Page	Part no.	Page	Part no.	Page
06801L	672	07367L	399	07660L-27	90	07812L	51
06802L	672	07368L	389	07660L-28	90	07820L	67
06805L	672	07369L	398	07660L-30	90	07821L	67
06810L	673	07370L	691	07660L-32	90	07822L	67
06815L	670	07371L	389	07660L-33	90	07823L	67
06816L	670	07372L	389	07660L-34	90	07824L	67
06816L-EINLAGE	670	07373L	395	07660L-36	90	07825L	67
06960L	103	07374L	396	07660L-38	90	07826L	67
06960L-KOFFER	103	07375L	396	07660L-4	89	07827L	67
07000L	654	07376L	389	07660L-41	90	07828L	67
07001L	656	07377L	389	07660L-44	90	07829L	67
07002L	656	07378L	388	07660L-46	90	07830L	67
07005L	655	07379L	388	07660L-5	89	07831L	67
07006L	655	07381L	388	07660L-50	90	07832L	67
07010L	654	07382L	388	07660L-6	89	07833L	67
07011L	654	07383L	398	07660L-9	88	07834L	67
07013L	654	07384L	521	07660L-KOFFER	87	07835L	67
07014L	654	07395L	243	07661L	89	07840L	69
07015L	655	07400SB	670	07661L-REP	89	07841L	69
07020L	655	07420L	671	07662L	94	07842L	69
07025L	672	07450L	110	07662L-REP	94	07843L	69
07050L	625	07500L	697	07663L	87	07844L	69
07051L	656	07605L	87	07663L-19	91	07845L	69
07052L	656	07620L	59	07663L-21	91	07846L	69
07065L	626	07620L-E10	71	07663L-22	91	07847L	69
07075L	626	07620L-E11	71	07663L-23	91	07848L	69
07080L	624	07620L-E12	71	07663L-24	91	07849L	69
07081L	624	07620L-E13	71	07663L-26	91	07850L	69
07082L	624	07620L-E14	71	07663L-27	91	07851L	69
07083L	624	07620L-E15	71	07663L-30	91	07852L	69
07091L	624	07620L-E16	71	07663L-32	91	07853L	69
07092L	625	07620L-E17	71	07663L-34	91	07854L	69
07301L	673	07620L-E18	71	07663L-36	91	07861L	509
07302L	673	07620L-E19	71	07663L-38	91	07865L	507
07305L	692	07620L-E20	71	07663L-41	91	07870L	507
07306L	578	07620L-E21	71	07663L-46	91	07871L	508
07308L	692	07620L-E22	71	07663L-48	91	07872L	508
07309L	691	07620L-E24	71	07663L-50	91	07873L	508
07311L	692	07620L-E27	71	07665L	101	07878L	508
07312L	692	07620L-E30	71	07665L-KOFFER	101	07879L	508
07315L	691	07620L-E32	71	07675L	94	07880L	508
07316L	692	07620L-E8	71	07675L-1	94	07881L	508
07354L	183	07620L-E9	71	07675L-2	94	07882L	508
07355L	693	07620L-ZK16	315	07675L-36	96	07883L	508
07356L	655	07620L-ZK21	315	07675L-41	96	07887L	507
07357L	655	07624L	59	07675L-46	96	07888SB	507
07358L	655	07624L-KOFFER	59	07675L-50	96	07890L	509
07362L	397	07630L	100	07675L-55	96	07890L-17	509
07362L-1	397	07630L-KOFFER	100	07675L-60	96	07890L-19	509
07362L-10	397	07631L	98	07675L-65	96	07890L-21	509
07362L-2	397	07635L	99	07675L-70	96	07890L-22	509
07362L-3	397	07635L-KOFFER	99	07675L-75	96	07900L	90
07362L-4	397	07650L	87	07675L-80	96	07900L-17	90
07362L-5	397	07660L	87	07685L	101	07900L-175	89
07362L-6	397	07660L-19	90	07805L	69	07900L-18	90
07362L-7	397	07660L-21	90	07806L	64	07900L-19	90
07362L-8	397	07660L-22	90	07807L	64	07900L-22	90
07362L-9	397	07660L-23	90	07808L	64	07900L-24	90
07363L	395	07660L-24	90	07809L	65	07900L-27	90
07365L	388	07660L-26	90	07811L	65	07900L-30	90



# Part no. Index



Part no.	Page	Part no.	Page	Part no.	Page	Part no.	Page
07900L-32	90	07960L	68	08454L	404	09660L	234
07900L-33	90	07960L-KOFFER	68	08460-36/6	402	09665L	233
07900L-36	90	07980L	95	08460-84/14	402	09665L-10	233
07900L-400	89	07980L-24	96	08460L	402	09665L-3	233
07900L-41	90	07980L-27	96	08463L	403	09665L-4	233
07900L-46	90	07980L-30	96	08465L	404	09665L-5	233
07900L-50	90	07980L-32	96	08465L-107	404	09665L-6	233
07900L-55	90	07980L-36	96	08465L-135	404	09665L-7	233
07900L-RING	93	07980L-39	96	08465L-74	404	09665L-8	233
07900L-STIFT	93	07980L-41	96	08470L	393	09665L-9	233
07901L	52	07980L-46	96	08475L	414	09675L	234
07901SB	104	07980L-55	96	08480L	251	09680L	233
07902L	52	07980L-60	96	08485L	405	09681L	233
07902SB	104	07980L-65	96	08490L	252	09690L	232
07903L	52	07980L-70	96	08493L	543	09690L-1	232
07903SB	104	07985L-175	94	08500L	732	09691L	232
07904L	41	07985L-22	95	08510L	173	10001L	234
07904SB	104	07985L-24	95	08641L	358	10002L	233
07905L	41	07985L-27	95	08650L	358	10003L	487
07905SB	104	07985L-30	95	08701L	359	10004L	236
07906L	41	07985L-32	95	08702L	359	10005L	234
07906SB	104	07985L-33	95	08800L	223	10006L	234
07910L	91	07985L-330	94	08801L	223	10007L	235
07910L-19	91	07985L-36	95	08802L	223	10008L	235
07910L-22	91	07985L-41	95	08803L	223	10009L	449
07910L-24	91	07985L-46	95	08804L	223	10010L	235
07910L-27	91	07985L-50	95	08805L	223	10011L	235
07910L-30	91	07985L-55	95	08820L	223	10012L	235
07910L-32	91	07985L-60	95	08901L	224	10015L	235
07910L-36	91	07985L-65	95	08902L	224	10016L	493
07910L-41	91	07985L-RING	96	08903L	224	10017L	449
07910L-46	91	07985L-STIFT	97	08904L	224	10019L	235
07910L-50	91	07986SB	483	08905L	224	10020L	446
07915L	104	08200L	580	08906L	224	10021L	446
07916L	41	08201L	581	08907L	224	10022L	446
07917L	51	08202L	581	09030L	226	10027L	490
07918L	65	08300SB	401	09040L	226	10028L	446
07920L	104	08310L	401	09050SB	529	10029L	446
07920L-KOFFER	104	08315SB	401	09102L	183	10032L	440
07925L	106	08320SB	401	09103L	183	10032L-1	441
07929L	106	08401SB	400	09104L	184	10032L-2	440
07930L	104	08405L	400	09106L	556	10032L-3	440
07930L-KOFFER	104	08410L	400	09300L	529	10032L-4	440
07931L	52	08411L	400	09310L	530	10032L-5	440
07932L	65	08412L	400	09320SB	529	10032L-6	440
07933L	66	08413L	400	09321L	529	10032L-7	440
07934L	89	08420SB	401	09322L	529	10032L-8	440
07935L	105	08425SB	402	09510L	231	10032L-9	440
07936L	41	08426L	402	09515L	231	10033L	735
07937L	89	08431L	399	09525L	231	10036L	735
07938L	95	08432L	414	09533L	493	10037L	735
07939L	52	08433L	414	09536L	566	10039L	785
07940L	88	08435L	402	09550L	232	10048L	445
07942L	92	08438L	402	09551L	232	10049L	447
07950L	67	08440L	402	09552L	232	10065L	785
07951L	67	08445L	400	09553L	232	10068L	785
07952L	67	08446L	175	09554L	232	10071L	786
07953L	67	08450L	403	09615L	231	10072L	786
07954L	67	08452L	403	09620L	231	10090L	485
07955L	67	08453L	403	09650L	234	10100L	443

Part no.	Page	Part no.	Page	Part no.	Page	Part no.	Page
10101L	443	10195L-16L	79	10316L	787	10586L-REP	321
10104L	445	10195L-18K	79	10318L	787	10587L	324
10105L	445	10195L-18L	79	10319L	480	10588L	323
10106L	482	10196L	71	10320L	790	10589L	322
10107L	482	10197L	93	10321L	789	10590L	736
10108L	326	10198L	71	10322L	96	10591L	323
10111L	93	10199L	93	10323L	96	10592L	331
10112L	486	10200L	496	10324L	96	10610L	318
10115L	487	10207L	495	10325L	380	10640L	315
10116L	491	10210L	496	10326L	788	10641L	315
10116L-1	491	10211L	496	10327L	788	10645L	314
10116L-2	491	10220L	496	10328L	788	10650L	619
10116L-3	491	10225L-0	497	10329L	788	10655L	619
10116L-4	491	10225L-1	496	10331L	789	10655L-T	619
10117L	491	10225L-12	497	10332L	789	10660L	620
10120L	564	10225L-13	497	10333L	786	10701L	318
10121L	564	10225L-2	496	10334L	476	10702L	318
10122L	565	10225L-3	497	10335L	476	10703L	318
10122L-1	565	10225L-5	497	10336L	449	10900L	318
10122L-2	565	10225L-6	497	10339L	475	11000SB	211
10122L-5	565	10225L-7	497	10341L	475	11005L	211
10123L	564	10225L-8	497	10365L	499	11100L	702
10124L	613	10225L-9	497	10365L-6	499	11101L	702
10126L	564	10240L	500	10402L	232	11102L	591
10127L	563	10241L	500	10403L	232	11105SB	702
10128L	565	10242L	500	10405L	231	11110L	702
10135L	445	10243L	500	10440L	488	11120L	591
10140L	475	10246L	500	10441L	488	11200L	591
10150L	485	10250L	495	10501L	423	11210L	591
10153L	526	10255L	495	10502L	423	11220L	591
10154L	526	10259L	522	10503L	423	11230L	591
10155L	526	10259L-2	523	10505L	424	11230L-1	591
10156L	526	10262L	522	10515L	213	11231L	591
10157L	526	10262L-1	522	10520L	424	11301L	590
10158L	526	10270L	498	10530L	423	11302L	590
10160L	487	10276L	498	10535L	423	11311L	590
10161L	487	10277L	493	10536L	423	11312L	590
10162L	487	10278L	493	10540L	423	11321L	590
10181L	71	10279L	494	10545L	423	11322L	590
10185L	70	10280L	494	10550L	336	11331L	590
10186L	88	10281L	494	10551L	354	11332L	590
10186L-14	93	10282L	494	10554L	336	11341L	590
10186L-17	93	10283L	495	10556L	336	11342L	590
10186L-19	93	10284L	495	10557L	320	11351L	590
10186L-24	92	10285L	495	10558L	320	11361L	590
10186L-27	92	10286L	495	10559L	322	11371L	590
10186L-30	92	10300L	498	10560L	336	11381L	590
10186L-32	92	10301L	498	10565L	355	11391L	590
10186L-34	92	10302L	498	10568L	322	11401L	590
10186L-35	92	10303L	498	10569L	322	11402L	590
10186L-36	92	10304L	498	10573L	323	11501L	706
10189L	71	10305L	499	10574L	323	11502L	706
10190L	71	10307L	789	10575L	324	11511L	705
10191L	71	10308L	499	10577L	356	11512L	705
10192L	71	10310L	499	10579L	320	11521L	703
10194L	71	10311L	786	10580L	335	11522L	703
10195L	79	10312L	786	10582L	321	11531L	704
10195L-14K	79	10313L	787	10583L	321	11532L	704
10195L-14L	79	10314L	787	10584L	321	11533L	704
10195L-16K	79	10315L	787	10586L	321	11541L	704



# Part no. Index



Part no.	Page	Part no.	Page	Part no.	Page	Part no.	Page
11542L	704	21008L	386	23060L	567	25020L	250
11551L	704	21009L	386	23060L-1	567	25029L	253
11552L	704	21010L	285	23060L-2	567	25030L	513
11561L	705	21011L	386	23060L-3	567	25031L	514
11562L	705	21012L	386	23060L-4	567	25032L	513
20301L	290	21013L	386	23060L-5	567	25033L	513
20302L	290	21014L	386	23070L	567	25034L	513
20303L	290	21015L	386	23080L	583	25036L	513
20304L	291	21016L	386	24000L	230	25037L	513
20305L	291	21017L	386	24002L	373	25038L	513
20307L	414	21018L	386	24003L	373	25039L	254
20308L	413	21019L	386	24005L	372	25040L	255
20309L	413	21020L	386	24006L	367	25043L	257
20310L	290	21021L	386	24010L	230	25044L	256
20315L	290	21023L	385	24015L	404	25045L	255
20320L	475	21024L	386	24016L	405	25046L	253
20335L	556	21025L	386	24020L	230	25047L	256
20335L-1	556	21026L	385	24025L	372	25048L	253
20340L	567	21027L	386	24031L	415	25049L	257
20400L	505	21030L	384	24032L	415	25050L	248
20405L	505	21040L	387	24033L	415	25051L	255
20450L	505	21042L	387	24034L	415	25055L	250
20455L	505	21043L	387	24035L	406	25061L	256
20460L	505	21044L	387	24036L-10	415	25065L	252
20465L	505	21045L	387	24036L-11	415	25066L	252
20470L	505	21046L	387	24036L-12	415	25070L	252
20475L	505	21047L	387	24036L-9	415	25080L	256
20500L	581	21048L	387	24037L	366	25081L	256
20505L	582	21049L	385	24501L	549	25082L	256
20601L	505	21049L-1	385	24503L	549	25083L	256
20602L	505	21049L-2	385	24504L	549	25084L	256
20605L	505	21049L-3	385	24510L	549	25085L	257
20606L	505	21050L	285	24514L	549	25086L	257
20700L	504	21051L	285	24516L	549	25087L	257
20710L	505	21052L	285	24517L	549	25088L	257
20720L	688	21500L	285	24518L	548	25089L	257
20721L	688	21505L	285	24520L	548	25090L	257
20723L	688	21510L	610	24520L-1	548	25091L	254
20724L	688	21514L	245	24520L-10	548	25092L	254
20724L-1	688	21515L	231	24520L-11	548	25093L	254
20731L	504	21516L	245	24520L-12	548	25094L	254
20735L	523	21517L	245	24520L-13	548	25095L	254
20740L	504	21518L	245	24520L-14	548	25096L	255
20741L	504	21519L	246	24520L-15	548	25097L	255
20800L	689	21550L	286	24520L-16	548	25098L	255
20810L	689	21550L-1	286	24520L-17	548	25200L	240
20820L	737	21550L-2	286	24520L-2	548	25201L	240
20910L	690	21555L	542	24520L-3	548	25202L	240
20915L	690	22201L	504	24520L-4	548	25203L	240
20950L	690	22400L	709	24520L-5	548	25204L	240
20950L-Rolle	690	23010L	584	24520L-6	548	25999L	326
20960L	690	23020L	584	24529L	547	26000SB	423
21000L	385	23027L	584	24530L	549	26001L	328
21001L	385	23028L	584	24535L	548	26002L	374
21002L	387	23037L	584	24540L	549	26003L	176
21003L	387	23038L	585	25000L	250	26004L	176
21004L	386	23039L	585	25005L	250	26005L	176
21005L	386	23040L	583	25010L	245	26006L	375
21006L	386	23041L	583	25015L	246	26007L	367
21007L	386	23045L	249	25016L	246	26008L	333

Part no.	Page	Part no.	Page	Part no.	Page	Part no.	Page
26009L	352	26071L	280	26142L	338	26536L	292
26011L	330	26073L	283	26143L	344	26537L	292
26012L	331	26074L	281	26144L	344	26540L	293
26013L	368	26078L	282	26145L	340	26541L	293
26014L	374	26078L-1	282	26146L	298	26542L	293
26015L	328	26078L-2	282	26147L	299	26543L	293
26016L	353	26079L	282	26148L	299	26544L	293
26017L	335	26080L	332	26149L	299	26545L	293
26018L	356	26081L	335	26150L	300	26546L	293
26021L	345	26082L	335	26151L	298	26547L	293
26022L	329	26083L	333	26152L	298	26548L	293
26023L	351	26084L	327	26153L	303	26549L	293
26024L	349	26086L	330	26154L	334	26550L	293
26025L	368	26089L	335	26154L-1	334	26551L	293
26026L	425	26090L	351	26154L-2	335	26552L	293
26028L	383	26091L	282	26157L	408	26553L	293
26029L	347	26091L-1	282	26158L	425	26554L	293
26031L	294	26092L	333	26159L	329	26555L	293
26032L	380	26093L	283	26160L	346	26556L	293
26033L	352	26094L	346	26161L	337	26557L	292
26034L	367	26095L	347	26163L	340	26558L	292
26035L	354	26096L	347	26164L	338	26559L	292
26036L	355	26097L	347	26165L	338	26560L	292
26040L	427	26098L	347	26166L	284	26561L	292
26041L	428	26100L	3423	26167L	342	26562L	292
26042L	302	26103L	339	26168L	355	26563L	292
26043L	348	26104L	339	26169L	332	26564L	292
26044L	337	26105L	341	26170L	314	26565L	292
26045L	300	26106L	340	26173L	350	26566L	293
26045L-1	301	26107L	299	26175L	349	26567L	293
26045L-2	301	26108L	339	26176L	345	26568L	293
26045L-3	301	26110L	282	26200L	407	26569L	293
26045L-4	301	26111L	342	26201L	408	26570L	293
26045L-5	301	26112L	341	26202L	432	26571L	293
26045L-6	301	26113L	349	26203L	375	26572L	293
26045L-7	302	26114L	342	26204L	374	26573L	293
26046L	281	26115L	281	26504L	294	26574L	293
26046L-01	281	26118L	733	26505L	683	26575L	293
26046L-02	281	26119L	281	26506L	294	26580L	293
26046L-03	281	26120L	296	26510L	292	26590L	294
26046L-04	281	26121L	375	26511L	293	26596L	291
26046L-05	281	26122L	375	26512L	293	26597L	291
26046L-C	281	26123L	375	26513L	293	27001L	331
26046L-T	281	26124L	296	26514L	293	30000L	680
26047L	327	26126L	297	26515L	293	30002L	681
26048L	351	26127L	297	26516L	293	30003L	681
26050L-1	428	26128L	298	26520L	292	30005L	561
26050L-2	428	26129L	297	26521L	292	30009L	680
26050L-3	428	26130L	346	26522L	292	30012SB	679
26050L-4	428	26131L	332	26523L	292	30014L	142
26052L	353	26132L	334	26524L	292	30015L	681
26053L	344	26133L	330	26526L	292	30016L	679
26054L	327	26134L	353	26527L	292	30017SB	679
26055L	428	26135L	352	26528L	292	30019L	680
26057L	326	26136L	354	26530L	292	30020L	681
26057L-KOFFER	326	26137L	327	26531L	292	30021L	680
26058L	351	26138L	350	26532L	292	30022SB	678
26059L	348	26139L	345	26533L	292	30030L	141
26060L	286	26140L	348	26534L	292	30060L	736
26067L	183	26141L	348	26535L	292	301013L	476



# Part no. Index



Part no.	Page	Part no.	Page	Part no.	Page	Part no.	Page
301015L	476	301445L	461	302326L	473	302500L	366
301025L	93	301448L	472	302327L	471	302501L	366
301030L	476	301449L	451	302328L	474	302600L	790
301031L	476	301452L	473	302329L	474	302601L	790
301032L	476	301453L	473	302330L	464	302700L	417
301050L	478	301454L	473	302331L	470	30501L	138
301051L	480	301462L	461	302332L	459	30600L	139
301051L-11	478	301487L	469	302333L	470	30601L	139
301055L	481	301489L	469	302334L	472	30602L	139
301057L	300	301494L	468	302335L	473	30603L	139
301064L	490	301514L	486	302336L	473	30604L	139
301065L	490	301528L	794	302337L	472	30605L	139
301066L	490	301553L	581	302338L	473	30701L	139
301087L	478	302100L	439	302339L	468	30702L	139
301092L	478	302101L	442	302340L	469	30703L	139
301096L	478	302102L	439	302341L	469	30751L	140
301097L	478	302103L	439	302342L	470	30752L	140
301105L	478	302104L	457	302343L	470	30753L	140
301110L	478	302106L	440	302344L	471	30800L	138
301120L	441	302200L	486	302345L	471	30901L	139
301155L	478	302201L	485	302346L	466	30902L	139
301169L	492	302202L	485	302348L	474	30903L	139
301177L	481	302203L	486	302349L	474	30904L	139
301178L	481	302204L	484	302350L	468	30905L	139
301179L	481	302207L	476	302351L	457	30906L	139
301185L	478	302208L	480	302352L	465	31001L	139
301229L	463	302209L	481	302353L	490	31002L	139
301232L	458	302213L	484	302400L	451	31003L	139
301237L	456	302214L	480	302401L	447	31004L	139
301240L	464	302215L	479	302402L	449	31100L	141
301249L	464	302216L	479	302403L	448	31200L	141
301250L	464	302217L	479	302404L	448	31208L	134
301257L	456	302218L	480	302405L	450	31210L	134
301266L	447	302220L	485	302406L	447	31215L	134
301267L	447	302221L	481	302407L	448	31220L	134
301279L	473	302222L	476	302408L	451	31225L	134
301288L	450	302300L	471	302409L	450	31227L	134
301289L	454	302301L	472	302410L	450	31230L	134
301291L	454	302302L	465	302411L	448	31240L	134
301295L	454	302304L	468	302412L	448	31400L	141
301298L	463	302305L	468	302413L	454	31401L	133
301300L	455	302307L	466	302414L	458	31402L	133
301309L	464	302308L	467	302415L	458	31403L	133
301313L	454	302309L	469	302416L	453	31411L	132
301316L	471	302310L	470	302417L	459	31412L	132
301325L	451	302311L	465	302418L	456	31413L	132
301331L	460	302312L	465	302419L	456	31414L	132
301333L	472	302313L	465	302421L	456	31415L	132
301377L	791	302314L	466	302422L	459	31450L	141
301384L	791	302315L	466	302424L	459	31455L	130
301406L	450	302316L	466	302425L	459	31456L	130
301408L	450	302317L	467	302426L	460	31457L	130
301411L	450	302318L	467	302427L	461	31500L	131
301413L	457	302319L	467	302428L	460	31505L	131
301419L	457	302320L	467	302429L	460	31510L	131
301423L	450	302321L	467	302431L	453	31510L-10	135
301428L	455	302322L	469	302432L	460	31510L-15	135
301429L	458	302323L	474	302433L	453	31510L-20	135
301430L	458	302324L	466	302434L	461	31510L-25	135
301444L	461	302325L	473	302435L	446	31510L-27	135

Part no.	Page	Part no.	Page	Part no.	Page	Part no.	Page
31510L-30	135	31753SB	131	32225L-10	609	37003L	530
31510L-40	135	31754SB	131	32225L-11	609	37004L	530
31510L-45	135	31755SB	131	32225L-12	609	37500L	539
31603L	132	31756SB	131	32225L-13	609	38000L	532
31604L	131	31760SB	132	32225L-14	609	38001L	532
31608L	132	31761SB	132	32225L-15	609	38003L	532
31609L	133	31762SB	132	32225L-16	609	38005L	361
31610L	140	31763SB	132	32225L-2	608	38007L	361
31650L	149	31791SB	138	32225L-3	608	400000L	561
31650L-10	149	31792SB	138	32225L-4	608	40000L	561
31650L-2	149	31794SB	137	32225L-5	608	40001L	561
31650L-3	149	31795SB	137	32225L-6	608	400021L	560
31650L-4	149	31798SB	137	32225L-7	609	400022L	560
31650L-5	149	31801SB	137	32225L-8	609	400024L	558
31650L-6	149	31802SB	137	32225L-9	609	40002L	559
31650L-7	149	31803SB	137	32226L	608	40002L-1	559
31650L-8	149	31804SB	137	32228L	609	40002L-2	559
31655L	150	31805SB	137	32229L	286	40002L-3	559
31655L-14	150	31806SB	137	32230L	606	40002L-4	560
31655L-2	150	31810L	130	32231L	606	40002L-5	559
31655L-3	150	31811L	130	32235L	606	40002L-6	560
31655L-8	150	31812L	130	32250L	590	400030L	249
31660L	151	31813L	130	32255L	607	400035L	557
31660L-T10	151	31814L	130	32280L	610	400036L	558
31660L-T15	151	31815L	130	32281L	610	40003L	249
31660L-T20	151	31816L	136	32291L	280	40006L	559
31660L-T25	151	31817L	130	32300L	140	40007L	558
31660L-T27	151	31901SB	138	32310L	140	40008L	248
31660L-T30	151	31902SB	138	32320L	140	40015L	558
31660L-T40	151	31903SB	138	32403L	711	40016L	558
31660L-T45	151	31904SB	138	32404L	711	40017L	560
31660L-T50	151	31905SB	138	32410L	710	40020L	249
31665L	151	31906SB	138	32411L	710	40120L	163
31665L-10	152	32000L	130	32500L	150	40130L	163
31665L-15	152	32001L	132	32500L-T10	151	402001	173
31665L-20	152	32002L	132	32500L-T15	151	402002	173
31665L-25	152	32003L	132	32500L-T20	151	402003	173
31665L-27	152	32005L	133	32500L-T25	151	402006SB	173
31665L-30	152	32006L	133	32500L-T27	151	402010L	314
31665L-40	152	32007L	133	32500L-T30	151	40210L	164
31665L-45	152	32100L	619	32600SB	140	40220L	164
31665L-50	152	32100L-1	619	34000L	613	40405L	161
31665L-55	152	32100L-CE01	619	34005L	613	40410L	161
31665L-60	152	32100L-CE02	619	34008L	265	40450L	161
31701SB	610	32100L-CE05	619	34015SB	613	40460L	161
31702SB	610	32100L-CE53	619	34020L	613	40505L	162
31705SB	319	32100L-CE56	619	34035L	611	405130L	286
31706SB	134	32100L-CE91	619	34036L	265	40535L	161
31707SB	134	32120L	619	34070L	266	40536L	162
31708SB	134	32150L	619	34100L	267	40537L	161
31709SB	134	32160L	618	34500L	266	40550L	162
31710SB	134	32200L	319	34510L	266	40560L	162
31715SB	134	32201L	319	34520L	266	40580L	162
31720SB	134	32215SB	609	34521L	266	40590L	168
31725SB	134	32220L	606	36000L	105	40591L	168
31727SB	134	32221L	606	36015L	110	40706L	156
31730SB	134	32222L	607	37000L-10	539	40710L	158
31741SB	133	32224L	607	37000L-8	539	40710L-1	163
31742SB	133	32225L	608	37001L	530	40710L-2	163
31752SB	131	32225L-1	608	37002L	530	40710L-3	163



# Part no. Index



Part no.	Page	Part no.	Page	Part no.	Page	Part no.	Page
40711L	163	41435L	487	42590L	616	50004-XXXL	701
40712L	163	41440L	177	42700L	600	50005-L	701
40735L	162	41441L	518	42700SB	167	50005-M	701
40736L	162	41442L	177	42710L	167	50005-S	701
40740L	163	41445L	516	42730L	227	50005-XL	701
40750L	163	41460L	176	42731L	227	50005-XXL	701
40755L	163	41461L	177	42732L	227	50005-XXXL	701
40790L	168	41470L	157	42733L	227	50101L	219
40791L	168	41500L	165	42734L	227	50102L	219
40805L	542	41501L	165	42735L	227	50103L	219
40810L	178	41502L	166	42736L	227	50104L	219
40811L	178	41505L	166	42740L	228	50105L	219
40820L	541	41515L	166	42741L	228	50106L	219
40830L	541	41516L	166	42742L	228	50107L	219
410100L	418	41520L	166	42743L	228	50108L	219
410105L	399	41521L	166	42744L	228	50109L	219
410110L	418	41530L	546	42745L	228	50110L	220
410111L	419	41545L	601	42746L	228	50111L	220
410113	418	41551L	165	42750L	167	50112L	220
410114L	418	41552L	165	42760L	166	50113L	220
410115L	418	41560L	158	42761L	167	50114L	220
410120L	419	41561L	158	42761L-1	167	50115L	220
410131L	733	41718L	159	42761L-2	167	50116L	220
410132L	733	41725L	160	42761L-3	167	50117L	220
410150L	417	41732L	160	42761L-4	167	50118L	220
41100L	364	41740L	160	42800L	167	50119L	220
41101L	364	41900L	160	45000L	174	50120L	220
41102L	364	41903L	156	45001L	174	50121L	220
41113L	364	41905L	159	45050L	164	50122L	220
41114L	364	41917L	160	45060L	164	50123L	220
41115L	364	41924L	160	45070L	164	50124L	220
41116L	364	41930L	160	45080L	164	50125L	220
41117L	364	41935L	158	50000-L	700	50126L	220
41118L	364	41950L	160	50000-M	700	50127L	220
41119L	364	41965L	159	50000-S	700	50128L	220
41204L	359	41970L	160	50000-XL	700	50201L	220
412100L	359	42124L	159	50000-XXL	700	50202L	220
41217L	360	42210L	164	50000-XXXL	700	50203L	220
41221L	364	42220L	164	50001-L	700	50204L	220
41222L	364	42230L	164	50001-M	700	50403L	218
41223L	364	42250L	156	50001-S	700	50405L	218
41230L	734	42410SB	168	50001-XL	700	50408L	218
41260L	358	42415L	618	50001-XXL	700	50410L	218
41265L	359	42420L	168	50001-XXXL	700	50420L	218
41301L	172	42500L	169	50002-L	700	50430L	218
41302L	172	42501L	169	50002-M	700	50501L	221
41310L	172	42504L	169	50002-S	700	50502L	221
41315L	172	42511SB	728	50002-XL	700	50503L	221
41360L	172	42520L	170	50002-XXL	700	50600L	221
41360L-1	172	42550SB	169	50003-L	701	50601L	221
41401L	172	42565SB	169	50003-M	701	50602L	221
41402L	172	42566L	169	50003-S	701	50603L	221
41405L	157	42585L	169	50003-XL	701	50604L	221
41410L	157	42585L-A	169	50003-XXL	701	50605L	221
41415L	157	42585L-B	169	50003-XXXL	701	50606L	222
41416L	171	42585L-C	169	50004-L	701	50607L	222
41420L	533	42585L-D	169	50004-M	701	50610L	220
41430L	487	42585L-E	170	50004-S	701	50701L	221
41431L	487	42585L-F	169	50004-XL	701	50702L	221
41432L	487	42585L-H	170	50004-XXL	701	50703L	221



Part no.	Page	Part no.	Page	Part no.	Page	Part no.	Page
50705L	221	61760L	175	64340L-1	229	72350L-Batt	182
50707L	221	61765L	175	64350L	229	72351L	183
50712L	221	61771L	175	70100200	262	72360L	284
50820L	695	61773L	175	70100300	262	72375L	556
50830L	695	61774L	175	70100400	263	72400L	184
50840L	695	61776L	175	70100500	263	72405L	184
50902L	219	61777L	174	70100600	264	72410L	184
50903L	219	61777L-1	174	70100700	264	73401L	228
50904L	219	61780L	489	70100800	265	73402L	228
50905L	219	61790L	177	70100900	267	80010SB	191
50908L	219	61791L	177	70200201	262	80015SB	191
50910L	219	61805SB	592	70200301	262	80020SB	191
50915L	219	62000SB	592	70200302	262	80025SB	191
50920L	219	62001SB	592	70200303	262	80030SB	191
50930L	219	62005SB	267	70200304	262	80032SB	191
51102L	221	62010L	592	70200305	262	80035SB	191
51105L	221	62010SB	267	70200401	263	80040SB	191
51112L	222	62011L	592	70200402	263	80041SB	191
51113L	222	62012L	592	70200403	263	80042SB	191
51115L	222	62015SB	267	70200404	263	80045SB	191
51120L	221	62016L	381	70200701	264	80048SB	191
60510L	587	62017L	381	70200702	264	80050SB	191
60702SB	709	62018L	381	70200703	264	80055SB	191
60704SB	709	62019L	381	70200704	264	80060SB	191
60705SB	709	62030L	592	70200801	265	80065SB	191
60706L	710	62035L	592	70200802	265	80070SB	191
60708L	710	62040L	592	70200803	265	80075SB	191
60710L	710	62050L	592	70200804	265	80080SB	191
61201L	217	62052L	592	70200L	187	80085SB	191
61202L	217	62060L	591	70250L	188	80090SB	191
61203L	217	62100L	261	70618L	596	80095SB	191
61204L	217	62100L-1	261	70624L	596	80100SB	191
61301L	216	62100L-2	261	70632L	596	80105SB	191
61302L	216	62100L-3	261	70718L	596	80110SB	191
61303L	216	62100L-4	261	70724L	596	80115SB	191
61304L	216	62100L-5	261	70732L	596	80120SB	191
61405SB	217	62100L-6	261	71500L	187	80125SB	191
61409SB	217	62203SB	215	71600L	188	80130SB	191
61703L	374	62204SB	215	71615L	188	80190010	818
61704L	372	62210SB	215	71616L	188	80190011	818
61704L-1	372	62211L	215	71650L	188	80200L	189
61704L-2	372	62220L	215	71700L	187	80210000	436
61705L	372	62303SB	215	71705L	187	80210001	806
61706L	371	62304SB	215	71710L	187	80210100	441
61707L	371	62310SB	216	71800L	187	80210101	441
61708L	173	62315SB	216	72000L	184	80210102	441
61709L	372	62316SB	216	72050L	184	80210103	441
61710L	372	62320SB	216	72200L	184	80210L	190
61711L	372	62330L	215	72300SB	182	80220003	436
61712L	372	62500SB	218	72301L	182	80220004	812
61714L	371	62510L	218	72305L	357	80220005	812
61715L	174	64301L	229	72310L	517	80220006	812
61716L	371	64302L	229	72311L	517	80220007	436
61717L	371	64304L	229	72315SB	517	80220008	812
61718L	173	64305L	229	72330L	514	80220009	812
61719L	433	64310L	229	72335L	514	80220010	436
61720L	372	64311L	228	72340L	183	80220011	812
61740L	489	64311L-F	228	72345L	182	80220012	812
61742L	370	64315L	230	72347L	182	80220013	812
61743L	489	64340L	229	72350L	182	80220014	812



# Part no. Index



Part no.	Page	Part no.	Page	Part no.	Page	Part no.	Page
80220015	812	80290012	818	81200023	816	81200083	817
80220016	812	80290013	818	81200024	816	81200084	817
80220017	805	80290019	818	81200025	816	81200085	817
80220018	812	80290020	818	81200026	816	81200086	817
80220019	812	80290021	818	81200027	816	81200087	817
80220020	812	80290022	818	81200028	816	81200088	817
80220021	812	80290030	805	81200029	816	81200089	817
80220022	812	80300L	188	81200030	816	81200090	817
80220023	812	80318L	189	81200031	816	81200091	817
80220024	812	80370L	227	81200032	816	81200092	817
80220025	436	80375L	227	81200033	816	81200093	817
80220026	812	80380L	227	81200034	816	81200094	817
80220027	812	80419L	189	81200035	816	81200095	817
80220028	812	80424L	189	81200036	816	81200096	436
80220029	812	80425L	189	81200037	816	81200097	436
80220032	436	80505L	189	81200038	816	81200098	436
80220033	436	80519L	189	81200039	816	81200099	817
80220034	811	80525L	189	81200040	816	81230000	437
80220035	811	80619L	190	81200041	816	81230100	437
80220036	438	80625L	190	81200042	816	81230200	436
80220037	811	80719L	190	81200043	816	81230300	438
80220040	811	80801SB	194	81200044	816	81230301	438
80220041	810	80802SB	194	81200045	816	81230400	438
80220042	811	80803SB	194	81200046	816	81230401	438
80220044	810	80804SB	194	81200047	816	81230402	438
80220045	810	80805SB	194	81200048	816	81230403	438
80220046	436	80806SB	194	81200049	817	81230404	438
80220047	436	80807SB	194	81200050	817	81230405	438
80220054	438	80808SB	194	81200051	817	81230500	436
80220055	438	80810SB	194	81200052	817	81230600	436
80220056	438	80811SB	194	81200053	817	81230700	437
80220057	438	80812SB	194	81200054	817	81230800	437
80220058	438	81110400	805	81200055	817	81230900	800
80220059	436	81110401	805	81200056	817	81231000	801
80220060	813	81110402	805	81200057	817	81231100	438
80220061	438	81110404	805	81200058	817	81231200	437
80220062	438	81110407	805	81200059	817	81231300	477
80220063	438	81110502	805	81200060	817	81231301	477
80220064	438	81200001	816	81200061	817	81231302	477
80220065	438	81200002	816	81200062	817	81231303	477
80220066	438	81200003	816	81200063	817	81231304	477
80220100	804	81200004	816	81200064	817	81231305	477
80220101	801	81200005	816	81200065	817	81231306	477
80220102	801	81200006	816	81200066	817	81231307	477
80220103	801	81200007	816	81200067	817	81231308	477
80220107	812	81200008	816	81200068	817	81231400	438
80220114	801	81200009	816	81200069	817	81231500	439
80220L	190	81200010	816	81200070	817	81231600	801
80290000	818	81200011	816	81200071	817	81301L	595
80290001	818	81200012	816	81200072	817	81302L	595
80290002	818	81200013	816	81200073	817	81303L	595
80290003	818	81200014	816	81200074	817	81304L	595
80290004	818	81200015	816	81200075	817	81305SB	595
80290005	818	81200016	816	81200076	817	81310L	595
80290010	818	81200017	816	81200077	817	81311L	595
80290011	818	81200018	816	81200078	817	81312L	595
		81200019	816	81200079	817	81313L	595
		81200020	816	81200080	817	81601L	201
		81200021	816	81200081	817	81602L	201
		81200022	816	81200082	817	81603L	201

Part no.	Page	Part no.	Page	Part no.	Page	Part no.	Page
81604L	201	81756L	202	81934L	203	82280L-4	198
81622L	200	81760L	202	81935L	203	82280L-5	198
81623L	200	81761L	202	81936L	203	82280L-6	198
81624L	200	81762L	202	81940L	203	82280L-7	198
81625L	200	81763L	202	82000L	203	82401L	197
81626L	200	81764L	202	82001L	203	82402L	197
81627L	200	81765L	202	82002L	203	82403L	197
81629L	200	81766L	202	82003L	203	82404L	197
81680L	208	81767L	202	82004L	203	82411SB	196
81685L	208	81768L	202	82005L	203	82412SB	196
81700L	201	81769L	202	82006L	203	82415L	196
81701L	201	81770L	202	82007L	203	82416L	196
81702L	201	81771L	202	82008L	203	82417L	196
81703L	201	81772L	202	82105L	211	82418L	197
81704L	201	81773L	202	82200-1,00	194	82420L	197
81705L	201	81774L	202	82200-1,50	194	82421L	197
81706L	201	81775L	202	82200-10,00	194	82450L-19	600
81707L	201	81776L	202	82200-3,00	194	82450L-22	600
81708L	201	81778L	202	82200-3,50	194	82450L-29	600
81709L	201	81780L	202	82200-4,00	194	82450L-35	600
81710L	201	81785L	201	82200-4,50	194	82450L-38	600
81711L	201	81790L	198	82200-5,50	194	82450L-44	600
81712L	201	81801L	200	82200-6,00	194	82450L-51	600
81713L	201	81802L	200	82200-6,50	194	82450L-57	600
81714L	201	81803L	200	82200-7,00	194	82450L-65	600
81715L	201	81804L	200	82200-7,50	194	82450L-68	600
81716L	201	81805L	200	82200-8,00	194	82451L	600
81717L	201	81806L	200	82200-9,00	194	82452L	600
81718L	201	81900L	203	82200-9,50	194	82500L	195
81719L	201	81901L	203	82200L	193	82501L	195
81720L	201	81902L	203	82200L-2,00	194	82510L	597
81721L	201	81903L	203	82211L	204	82550L	197
81722L	201	81904L	203	82212L	204	82560L	195
81723L	201	81905L	203	82213L	204	82570L	195
81724L	201	81906L	203	82214L	204	82580L	195
81725L	201	81907L	203	82215L	204	82588L	195
81726L	201	81908L	203	82216L	204	82591L	195
81727L	201	81909L	203	82220L	204	82600L	226
81728L	201	81910L	203	82222L	194	82601L	226
81729L	201	81911L	204	82223L	194	82602L	226
81730L	201	81912L	204	82224L	194	82603L	226
81731L	201	81913L	204	82225L	194	82604L	226
81732L	201	81914L	204	82226L	194	82605L	226
81733L	201	81915L	204	82227L	194	82606L	226
81734L	201	81916L	204	82229L	188	82607L	226
81735L	201	81917L	204	82230L	204	82620L	226
81736L	201	81918L	204	82231L	198	82625L	226
81737L	201	81919L	204	82233L	198	82630L	226
81738L	201	81920L	204	82240L	208	82640L	225
81739L	201	81921L	204	82245L	199	82641L	225
81740L	201	81922L	204	82246L	200	82642L	225
81741L	201	81923L	204	82250L	199	82643L	225
81742L	201	81924L	204	82250L-KOFFER	199	82644L	225
81743L	201	81925L	204	82250L-ZOLL	199	82645L	226
81750L	202	81926L	204	82251L	199	82646L	226
81751L	202	81927L	204	82255L	200	82647L	226
81752L	202	81930L	203	82280L	198	82648L	226
81753L	202	81931L	203	82280L-1	198	82650L	227
81754L	202	81932L	203	82280L-2	198	82651L	227
81755L	202	81933L	203	82280L-3	198	82652L	227



# Part no. Index



Part no.	Page	Part no.	Page	Part no.	Page	Part no.	Page
82653L	227	91302L	587	94864L	213	95080L	224
82660L	222	92520L	176	94870L	212	9600-M	247
82700L	205	92521L	176	94871L	212	9601-M	422
82701L	205	92522L	176	94872L	212	9602-M	422
82702L	205	92710L	187	94874L	213	9604-M	422
82703L	205	92720L	187	94875L	357	9605-M	422
82704L	205	93000L	593	94876L	357	9654-M	595
82705L	205	93005L	593	94876L-1	357	9662-M	595
84015L	205	93020L	249	94877L	363	EH-2	115
84016L	206	93605L	218	94878L	356	EH-4	115
84017L	206	93706SB	217	94880L	212	EH-5	114
84018L	206	93900L	216	94885L	579	IBO/4-10	116
84019L	206	93910L	216	94890L	568	IBO/4-10L	116
84020L	206	94000L	223	94899L	357	IBO/4-2L	116
84021L	207	94005L	223	94900L	356	IBO/4-3	116
84022L	207	94006L	223	95003L	225	IBO/4-3L	116
84023L	207	94007L	223	95004L	225	IBO/4-4	116
84024L	207	94008L	223	95005L	225	IBO/4-4L	116
84025L	207	94009L	223	95006L	225	IBO/4-5	116
84026L	207	94012L	362	95007L	225	IBO/4-5L	116
84027L	207	94040L	587	95008L	225	IBO/4-6	116
84028L	207	94042L	587	95009L	225	IBO/4-6L	116
84029L	207	94043L	587	95010L	225	IBO/4-7	116
84030L	207	94044L	587	95011L	225	IBO/4-7L	116
84031L	202	94045L	587	95012L	225	IBO/4-8	116
84032L	202	94100L	213	95013L	225	IBO/4-8L	116
84033L	202	94200L	213	95014L	225	IBO/8-10	120
84034L	202	94201L	214	95015L	225	IBO/8-12	120
84035L	202	94300L	213	95016L	225	IBO/8-14	120
84036L	202	94502L	222	95017L	225	IBO/8-7	120
84037L	202	94503L	222	95018L	225	IBO/8-8	120
84038L	207	94504L	222	95019L	225	IE/4-3	45
84039L	207	94510L	222	95020L	225	IE/4-4	45
84040L	207	94600L	227	95021L	225	IE/4-5	45
84041L	207	94800L	568	95022L	225	IE/4-6	45
84042L	207	94801L	568	95023L	225	IE/4-7	45
84043L	207	94802L	568	95024L	225	IE/4-8	45
84044L	207	94803L	568	95025L	225	IP/4-SET	47
90603SB	214	94804L	579	95026L	225	IP/4-T10	47
90605SB	185	94805L	579	95027L	225	IP/4-T15	47
90610L	185	94807L	568	95028L	225	IP/4-T20	47
90615L	185	94808L	172	95029L	225	IP/4-T25	47
90620L	186	94808L-1	172	95030L	225	IP/4-T27	47
90630L	186	94809L	579	95031L	225	IP/4-T30	47
90640L	185	94810SB	214	95032L	225	IP/4-T40	47
90645L	185	94815L	214	95033L	225	IP/4-T45	47
90657L	213	94815SB	214	95035L	225	IP/4-T50	47
90661L	186	94820L	214	95036L	225	KB/4-0	115
90665L	186	94825SB	214	95037L	225	KB/4-0L	115
90666L	186	94830L	530	95038L	225	KB/4-1	115
90670SB	185	94840L	213	95039L	225	KB/4-1L	115
90690SB	185	94845L	568	95040L	225	KB/4-2	115
90902SB	217	94850L	518	95041L	225	KB/4-2L	115
90931L	217	94855L	518	95042L	225	KB/4-3	115
90932L	217	94857L	518	95045L	225	KB/4-3L	115
90933L	217	94858L	518	95047L	225	KB/4-4	115
90934L	217	94860L	213	95048L	225	KB/4-4L	115
90935L	217	94861L	213	95050L	225	KB/8-3	119
91006L	214	94862L	213	95060L	224	KB/8-4	119
91301L	587	94863L	213	95070L	224	KE/4-0	44

Part no.	Page	Part no.	Page	Part no.	Page	Part no.	Page
KE/4-1	44	S1593-15	27	S1850	540	S3277	242
KE/4-2	44	S1593-16	27	S1850-1	531	S3278	242
KE/4-3	44	S1593-17	27	S1902	186	S3279	243
KOB-1,00	193	S1593-18	27	S1912	186	S3280	243
KOB-1,50	193	S1593-19	27	S2012	194	S3281	244
KOB-10,00	193	S1593-22	27	S2050	186	S3282	244
KOB-10,50	193	S1593-24	27	S21-120	60	S3283	244
KOB-11,00	193	S1593-8	27	S21-125	66	S3284	241
KOB-11,50	193	S1593-9	27	S21-202	142	S3517	590
KOB-12,00	193	S1594	28	S21-205	145	S3531	287
KOB-12,50	193	S1595	26	S2143	37	S3532	287
KOB-13,00	193	S1595-10	26	S2143-KOFFER	37	S3541	577
KOB-2,00	193	S1595-11	26	S2146	36	S3542	579
KOB-2,50	193	S1595-12	26	S2171	49	S3544	577
KOB-3,00	193	S1595-13	26	S2229	48	S3546	577
KOB-3,30	193	S1595-14	26	S2229-Gleit	50	S3547	578
KOB-3,50	193	S1595-15	26	S2229-KOFFER	48	S3591	709
KOB-4,00	193	S1595-16	26	S2229-PH1	56	S3598	709
KOB-4,20	193	S1595-17	26	S2229-PH2	56	S5100	73
KOB-4,50	193	S1595-18	26	S2229-PH3	56	S5106	78
KOB-5,00	193	S1595-19	26	S2229-PZ1	56	S5116	82
KOB-5,50	193	S1595-21	26	S2229-PZ2	56	S5117	74
KOB-6,00	193	S1595-22	26	S2229-PZ3	56	S5480	85
KOB-6,30	193	S1595-24	26	S2229-SE5,5	56	S5480-20	85
KOB-6,50	193	S1595-27	26	S2229-SE7	56	S5480-25	85
KOB-7,00	193	S1595-30	26	S2229-SE8	56	S5480-30	85
KOB-7,50	193	S1595-32	26	S2229-T15	58	S5480-40	85
KOB-8,00	193	S1595-8	26	S2229-T20	58	S5480-45	85
KOB-8,50	193	S1595-9	26	S2229-T25	58	S5480-50	85
KOB-8,80	193	S1596-10	27	S2229-T27	58	S5480-55	85
KOB-9,00	193	S1596-11	27	S2229-T30	58	S5480-60	85
KOB-9,50	193	S1596-12	27	S2229-T40	58	S5480-70	85
MH-4	114	S1596-13	27	S2229-T45	58	S5481	76
PB/4-1	116	S1596-14	27	S2229-T50	58	S5481-10	77
PB/4-1L	116	S1596-15	27	S2229-T55	58	S5481-12	77
PB/4-2	116	S1596-16	27	S2299	102	S5481-14	77
PB/4-2L	116	S1596-17	27	S3114-1	260	S5481-17	77
PB/4-3	116	S1596-18	27	S3114-2	260	S5481-19	77
PB/4-3L	116	S1596-19	27	S3119-1	260	S5481-5	77
PB/4-4	116	S1596-8	27	S3129	680	S5481-6	77
PB/4-4L	116	S1596-9	27	S3180	728	S5481-8	77
PB/8-3	120	S1597	28	S3200	260	S5482	79
PB/8-4	120	S1597-10	29	S3201	260	S5482-10	80
PE/4-0	44	S1597-11	29	S3211	247	S5482-12	80
PE/4-1	44	S1597-12	29	S3211-2	446	S5482-14	80
PE/4-2	44	S1597-13	29	S3213	247	S5482-16	80
PE/4-3	44	S1597-14	29	S3215	248	S5482-4	80
S1225	501	S1597-15	29	S3220	694	S5482-5	80
S1226	501	S1597-16	29	S3224	241	S5482-6	80
S1463	324	S1597-17	29	S3228	244	S5482-8	80
S1464	325	S1597-18	29	S3230	244	S5482-9	80
S1588	26	S1597-19	29	S3232	691	S5483	82
S1589	27	S1597-8	29	S3249	241	S5483-10	82
S1592	29	S1597-9	29	S3260	246	S5483-12	82
S1593	27	S1598	28	S3261	246	S5483-13	82
S1593-10	27	S1599-10x11	29	S3263	246	S5483-14	82
S1593-11	27	S1599-12X13	29	S3265	246	S5483-5	82
S1593-12	27	S1599-14X15	29	S3268	247	S5483-6	82
S1593-13	27	S1599-17x19	29	S3275	242	S5483-7	82
S1593-14	27	S1833	540	S3276	242	S5483-8	82



# Part no. Index



Part no.	Page	Part no.	Page	Part no.	Page	Part no.	Page
S5483-9	82	S8143	721	TBO/4-T10	117	TIN3,20	192
S7890	136	S8203	114	TBO/4-T10L	117	TIN3,50	192
S7891	137	S8204	114	TBO/4-T15	117	TIN4,00	192
S7891-KOFFER	137	S9611	614	TBO/4-T15L	117	TIN4,50	192
S7892	137	S9612	614	TBO/4-T20	117	TIN4,80	192
S8015	569	S9660	708	TBO/4-T20L	117	TIN5,00	192
S8016	569	S9710	677	TBO/4-T25	117	TIN5,50	192
S8017	569	S9711	679	TBO/4-T25L	117	TIN6,00	192
S8018	570	S9713	678	TBO/4-T27	117	TIN6,50	192
S8019	570	S9714	679	TBO/4-T27L	117	TIN7,00	192
S8020	570	S9725	677	TBO/4-T30	117	TIN7,50	192
S8021	571	S9730	678	TBO/4-T30L	117	TIN8,00	192
S8022	571	S9731	702	TBO/4-T40	117	TIN8,50	192
S8023	572	S9745	677	TBO/4-T40L	117	TIN9,00	192
S8024	572	S9752	677	TBO/4-T45	117	TIN9,50	192
S8025	573	S9780	676	TBO/4-T45L	117	TW-T10	147
S8026	573	S9781	676	TBO/4-T7	117	TW-T15	147
S8027	573	S9782	676	TBO/4-T7L	117	TW-T20	147
S8028	574	S9810	678	TBO/4-T8	117	TW-T25	147
S8029	574	S9811	678	TBO/4-T8L	117	TW-T27	147
S8030	574	S9935	195	TBO/4-T9	117	TW-T30	147
S8031	575	S9936	195	TBO/4-T9L	117	TW-T40	147
S8032	575	S9937	195	TBO/8-T40	120	TW-T45	147
S8033	575	SB/4-4	115	TBO/8-T45	120	TW-T50	147
S8034	576	SB/4-4L	115	TBO/8-T50	120	TW-T55	147
S8035	576	SB/4-5	115	TBO/8-T55	120	TW-T60	147
S8036	577	SB/4-5L	115	TBO/8-T60	120	TW-T8	147
S8037	720	SB/4-6,5	115	TBO/8-T70	120	VKB/4-0	118
S8038	370	SB/4-6,5L	115	TEM/4-T10	46	VKB/4-0L	119
S8039	727	SB/4-7	115	TEM/4-T15	46	VKB/4-1	118
S8040	720	SB/4-7L	115	TEM/4-T20	46	VKB/4-1L	119
S8041	722	SB/8-10	119	TEM/4-T25	46	VKB/4-2	118
S8042	721	SB/8-12	119	TEM/4-T27	46	VKB/4-2L	119
S8043	723	SB/8-8	119	TEM/4-T30	46	VKB/4-3	118
S8044	722	SE/4-4	44	TEM/4-T40	46	VKB/4-3L	119
S8045	722	SE/4-5	44	TEM/4-T8	46	XBO/4-4	117
S8046	723	SE/4-6,5	44	TEM/4-T9	46	XBO/4-4L	117
S8047	723	SE/4-7	44	TEO/4-T10	45	XBO/4-5	117
S8048	724	TBM/4-T10	118	TEO/4-T15	45	XBO/4-5L	117
S8049	723	TBM/4-T10L	118	TEO/4-T20	45	XBO/4-6	117
S8052	721	TBM/4-T15	118	TEO/4-T25	45	XBO/4-6L	117
S8053	725	TBM/4-T15L	118	TEO/4-T27	45	XBO/4-8	117
S8054	723	TBM/4-T20	118	TEO/4-T30	45	XBO/4-8L	117
S8055	724	TBM/4-T20L	118	TEO/4-T35	45	Z1120	156
S8058	727	TBM/4-T25	118	TEO/4-T40	45	Z1125	156
S8059	722	TBM/4-T25L	118	TEO/4-T7	45	Z2200	670
S8064	724	TBM/4-T27	118	TEO/4-T8	45	Z2300	669
S8065	727	TBM/4-T27L	118	TEO/4-T9	45	Z2500	657
S8066	724	TBM/4-T30	118	TIN1,00	192	Z2500-1	657
S8067	725	TBM/4-T30L	118	TIN1,50	192	Z2500-2	658
S8068	725	TBM/4-T40	118	TIN10,00	192	Z2500-3	658
S8073	726	TBM/4-T40L	118	TIN10,50	192	Z2500-4	658
S8100	728	TBM/4-T45	118	TIN11,00	192	Z2500-ADAPTER1	654
S8112	727	TBM/4-T45L	118	TIN11,50	192	Z2500-ADAPTER2	654
S8115	726	TBM/4-T7	118	TIN12,00	192	Z2500-ADAPTER3	654
S8116	726	TBM/4-T7L	118	TIN12,50	192	Z2525-1	664
S8120	727	TBM/4-T8	118	TIN13,00	192	Z2525-2	664
S8135	725	TBM/4-T8L	118	TIN2,00	192	Z2525-3	665
S8138	726	TBM/4-T9	118	TIN2,50	192	Z2525-4	665
S8142	721	TBM/4-T9L	118	TIN3,00	192	Z2525-5	665

Part no.	Page	Part no.	Page
Z2533-1	662	Z3013-2	643
Z2533-10	663	Z3013-20	649
Z2533-11	664	Z3013-21	649
Z2533-12	664	Z3013-22	649
Z2533-2	662	Z3013-23	649
Z2533-3	662	Z3013-24	650
Z2533-4	662	Z3013-25	650
Z2533-5	662	Z3013-26	650
Z2533-6	663	Z3013-27	650
Z2533-7	663	Z3013-28	652
Z2533-8	663	Z3013-29	651
Z2533-9	663	Z3013-3	643
Z2550-1	661	Z3013-30	651
Z2550-2	661	Z3013-31	651
Z2550-3	661	Z3013-32	651
Z2550-5	661	Z3013-33	652
Z2566-1	659	Z3013-34	652
Z2566-2	659	Z3013-35	652
Z2566-3	659	Z3013-36	648
Z2566-4	529	Z3013-37	645
Z2566-5	660	Z3013-38	653
Z2566-6	660	Z3013-4	644
Z2750	657	Z3013-5	644
Z3000-1	632	Z3013-6	644
Z3000-10	563	Z3013-7	644
Z3000-11	563	Z3013-8	645
Z3000-12	563	Z3013-9	645
Z3000-14	635	Z3023-1	641
Z3000-15	636	Z3023-2	641
Z3000-16	636	Z3023-3	642
Z3000-17	636	Z3023-4	642
Z3000-18	637	Z3023-5	642
Z3000-2	633	Z3131	632
Z3000-21	637	Z315	306
Z3000-23	637	Z3217	629
Z3000-25	638	Z3344	631
Z3000-26	638	Z3404	630
Z3000-27	638	Z3405	630
Z3000-3	633	Z3406	631
Z3000-4	633	Z3407	631
Z3000-5	634	Z3415	630
Z3000-6	634	Z3604	629
Z3000-7	634	Z3607	629
Z3000-8	635	Z3618	628
Z3000-9	635	Z3703	632
Z301	669	Z3817	627
Z3010-1	640	Z3818	627
Z3010-2	641	Z3822	628
Z3010-3	641	Z4200	671
Z3013-1	643	Z6000	668
Z3013-10	646	Z610	499
Z3013-11	646	Z630	705
Z3013-12	647	Z631	705
Z3013-13	646	Z632	704
Z3013-14	647	Z633	704
Z3013-15	647	Z634	705
Z3013-16	648	Z635	705
Z3013-17	648		
Z3013-18	648		
Z3013-19	653		















A large area of the page consisting of horizontal lines for taking notes, organized into two columns.

**Sales**

Your contact for enquiries on availability and price

+49 (0) 21 91 - 4 64 38 - 45

**Order by email**

Please only use this address for the fastest possible processing

order@swstahl.de

**Fax**

Our central number for all written documents

+49 (0) 21 91 - 4 64 38 - 40

**Service**

The experts for all technical questions on our products and for processing guarantee cases

+49 (0) 21 91 - 4 64 38 - 55

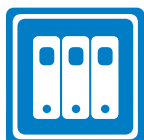
**Accounting**

For all questions on invoices, payments, vouchers

+49 (0) 21 91 - 4 64 38 - 35

**General terms and conditions**

Under the address <http://sw-stahl.com/Geschaeftsbedingungen.html>.

Exceptions are only valid following written confirmation

**SW-Stahl GmbH**

An der Hasenjagd 3  
DE-42897 Remscheid

District Court Wuppertal HRB 10527  
VAT ID: DE120807393

Managing director: Heiner Tilly

**Subject to printing errors and technical Modifications!**

All rights reserved. The text, images, graphics etc. used in this catalogue are subject to copyright and other laws protecting intellectual property.

Their disclosure, modification, commercial use or use in other media is not permitted. No part of this catalogue may be reproduced or distributed without written authorisation from SW-Stahl GmbH.

All illustrations have a symbolic value and can deviate from the original products.

The seller reserves the right to modify the design and designation of products and the materials used in their fabrication without prior notice. This enables us, in particular, to upgrade our products to state-of-the-art technology.

The seller also has the right to withdraw certain products from sale without prior notice.

**Quality**

Hobby / DIY  
Industry / Professional  
Premium

**Insert dimensions**

1/1 insert  
2/3 insert  
1/2 insert  
1/3 insert  
1/4 insert

**Drive**

6.3 mm (1/4") square		6.3 mm (1/4") hexagonal	
10 mm (3/8") square		8 mm hexagonal	
12.5 mm (1/2") square		10 mm hexagonal	
20 mm (3/4") square			
25 mm (1") square			

**Material:**

Chrome vanadium  
Chrome vanadium special steel  
Chrome-molybdenum  
High speed steel  
High speed steel cobalt alloyed

**Product feature**

Suitable for impact wrenches / IMPACT  
Magnetic  
Dimensions in inches

**Head design**

Tilted / hinge

**Interlocking**

Free run (without interlocking)		FREI
Fine interlocking		72
Standard interlocking		36

**Profile**

Five star with hole		Hexagonal	
External multi-profile		Spiral grooves	
Tri wing		T-section with hole	
E-section		T-section	
Internal hex		Multi-tooth	
" - Ball head		Multi-tooth with hole	
Cross		Four wing	
Pozidrive		Square	
RB-Profile		Wave profile	
Slot		Bi-hexagonal	

**Vehicle category**

Transporter  
Commercial vehicle  
Agricultural machinery  
Motorbikes  
Bicycles

**Certificates**

CE labelling  
Patent protected  
DIN  
VDE



# SW-Stahl

## Catalogue Overview



# SW-Stahl

HAND & SPECIALIST TOOLS