



JBM[®]
YOUR TOOLS

TOOL SETS

5

TOOL SETS
ALUMINIUM TOOL CASES
SOCKET SETS WITH RATCHET
SOCKET SETS
BIT SETS
SCREWDRIVER BIT SETS
SOCKET ADAPTORS
MINI RATCHET SET
SOCKET SETS
BIT SOCKET SETS
INSULATED TOOLS



HAND TOOLS

33

SPANNERS
SAE TOOLS
SCREWDRIVERS
MEASURING TOOLS
PADLOCKS
HAMMERS
HACKSAWS
CHISELS
RIVETERS
RATCHETS
EXTENSION BARS
INSPECTION TOOLS
TUBE CUTTERS
WIRE CUTTERS
PLIERS
PIPE WRENCHES
BAR CLAMPS



WORKSHOP FURNITURE

65

TOOL TROLLEYS
TOOL SETS
ACCESSORIES FOR TROLLEY
CABINETS AND CARTS
WORK BENCHES ACCESSORIES
WORK BENCHES
MODULAR TOOL BOXES /
CANTILEVERS
ADJUSTABLE SEATS /
MECHANIC'S CREEPER
VICES / ANVILS



POWER TOOLS CORDLESS

87

IMPACT WRENCH
SCREWDRIVER / RATCHET
IMPACT DRILL / BRUSHLESS ANGLE GRINDER
ORBITAL SANDER / POLISHER
SAWS
OSCILLATING MULTI TOOL
GUNS
VACUUM CLEANER / COMPRESSOR
LED WORK LIGHT
GARDENING POWER TOOLS
STORAGE
BATTERIES / CHARGERS
ACCESSORIES



LIGHTING

113

INSPECTION LAMPS
HEAD TORCHES
LED MAGNIFYING LAMP
FLOOD LIGHTS / LAMP CHECK ALIGNERS
/ CIGARRETTE LIGHTERS AND VOLTAGE CONVERTER
LED BARS
HIGH BAY LIGHT
BEACONS
ACOUSTIC ALARMS
LED WORK LAMP
TOWING LIGHT BARS
REPLACEMENT BULBS AND FUSES SETS



PNEUMATIC TOOLS

131

IMPACT WRENCHES
IMPACT WRENCHES FOR TRUCKS
DRILLS
POLISHERS
GRINDERS
PNEUMATIC BEAD BREAKER
SANDERS / POLISHERS
AIR IMPACT WRENCH
CUTTING TOOLS
AIR INFLATOR GUNS
OIL FILTERS
OTHER GUNS
AIR HOSE REEL
AIR HOSES
CONNECTOR HOSES / THREADS



IMPACT TOOLS

149

IMPACT TOOL SETS
EXTENSION BARS
BIT SETS
IMPACT ADAPTORS
IMPACT SOCKETS



BODY WORK

159

SHEET METAL WORK TOOLS
CAR HEADLIGHT
WELDING / PRY BARS
LOCK-OUT TOOL SETS
CLAMPS
CAULKING GUNS
SUBJECTION TAPES WITH TENSIONER
STANDS
CAR MAINTENANCE / DISPLAYERS
PADS
ALUMINIUM LADDERS
AND PLATFORMS



BRAKES

173

BRAKE PISTONS
RETRACTOR TOOLS
BRAKE BLEEDER /
MAINTENANCE



SPECIAL TOOLS

177

OIL FILTER WRENCHES
INJECTOR PULLERS
PLUG REPAIR SET
COMPRESSION TESTERS
IGNITION COIL PULLER
EXTRACTORS
RATCHET TORQUE WRENCHES
TORQUE MULTIPLIER
A/C SYSTEM
RADIATOR PRESSURE TESTER
CYLINDER / VALVES
SPRING COMPRESSORS
OTHERS
ORGANIZERS / TRAYS
CHAIN CUTTERS / BRUSHES



TIMING TOOLS

217

BMW
MERCEDES
VAG
RENAULT / NISSAN
FORD / MAZDA
JAGUAR / LAND ROVER
OPEL / VAUXHALL
CITROËN / PEUGEOT
VARIOUS
CABINET WITH TIMING TOOLS SET
/ EVA MODULES
SPECIAL TOOLS



LUBRICANT AND ACCESSORIES

247

TROLLEY JACKS
BOTTLE JACKS
CAR JACK STANDS
CAR TIRE DOLLYS
PRESSES
CRANES
ENGINE SUPPORTS
MOTORCYCLE LIFTER
MANUAL PALLET JACK



HYDRAULIC TOOLS

259

TROLLEY JACKS
BOTTLE JACKS
CAR JACK STANDS
CAR TIRE DOLLYS
PRESSES
CRANES
ENGINE SUPPORTS
MOTORCYCLE LIFTER
MANUAL PALLET JACK



ELECTRIC TOOLS

271

JUMP STARTER
BATTERY CHARGERS / TESTERS
MULTIMETERS
THERMOMETERS
ENDOSCOPES
WELDERS
BENCH GRINDERS
PARTS WASHER
VACUUM CLEANERS
HEATERS / LAWN MOWERS
HIGH PRESSURE CLEANERS
ELECTRIC CABLE REEL
FANS



RENEWABLE ENERGY AND MOBILITY OF THE FUTURE

285

PORTABLE POWER STATION
SOLAR PANELS
ELECTRIC CAR CHARGERS
ELECTRIC CAR ACCESSORIES
INSULATED TOOLS



ACCESSORIES

291

HOSE REELS
LADDERS
TROLLEYS
ORGANIZERS
CAR ACCESSORIES
EMERGENCY / SAFETY KITS
PARKING SENSORS
MATS
WIPE BLADERS
WHEEL WEIGHTS
TPMS VALVES
TYRE VALVES
JOINT BOOT SETS



SAFETY AND PPE

315

GLOVES / IPE
FIRST AID KIT
MASKS / DISPENSERS
THERMAL CAMERA
/ THERMOMETERS / SURFACE
CLEANERS
SAFETY DISTANCE
OZONE GENERATOR / METER



CONSUMABLES

323

GROMMETS / ROLL PINS
COTTER PINS / SCREWS
NUT RIVETS
WASHERS
VALVE CORES
O-RINGS
/ HEAT SHRINK SOLDER SLEEVES
GREASE NIPPLE FITTINGS
HOSE CLAMPS / SPRINGS / FUSES
WIRE CONNECTORS
PLASTIC CLIPS



CLOTHING

345

VEST
JACKET



PROMOTIONAL

347

ELECTRONIC DEVICES
JBM
PROMOTIONAL
DISPLAYS AND
ACCESSORIES
PACKAGING





JBM is your brand for professional tools

Leading company specialised in the industry and automotive sector

+5.000 PRODUCTS AVAILABLE

+20.000 EUROPALLETS IN STOCK

+450 NEW PRODUCTS EVERY YEAR

+55 EXPORTING TO MORE THAN 55 COUNTRIES

QUALITY SERVICE
BACKED BY MORE THAN
11,000 CUSTOMERS

▶ MORE THAN 30 YEARS EXPERIENCE IN THE SECTOR

At JBM we are specialists in the distribution of automotive tools and equipment, offering a close and quality service to our more than 11,000 customers in more than 55 countries.

▶ DISTRIBUTION AND LOGISTICS EXPERTS

JBM has a constantly improving logistic network that allows a fast and efficient distribution not only in the Iberian Peninsula but also to all international customers.

▶ WIDE RANGE OF PRODUCTS

We offer a complete range of more than 4,000 items in tool boxes, tool cases, all types of hand tools, tool cabinets, workshop tools, lighting, consumable cases...



DELIVERY WITHIN 24-48H ON THE IBERIAN PENINSULA AND FRANCE



HEADQUARTERS IN SPAIN AND WAREHOUSE OF MORE THAN 6.000M²





TOOL SETS

- 7 TOOL SETS
- 20 ALUMINIUM TOOL CASES
- 23 SOCKET SETS WITH RATCHET
- 24 SOCKET SETS
- 25 BIT SETS
- 27 SCREWDRIVER BIT SETS
- 28 SOCKET ADAPTORS
- 29 MINI RATCHET SET
- 29 SOCKET SETS
- 29 BIT SOCKET SETS
- 31 INSULATED TOOLS

HIGH-QUALITY FINISHES



DIVISIBLE
IN TWO
FOR A BETTER
ORGANIZATION



IMPROVED METAL
LOCKS



RUBBER HANDLE
FOR BETTER GRIP



216 PIECES HEXAGONAL SOCKET AND RATCHET SPANNER

54034

178,00€

11.45	-	2	48
Kg	SUB	11	

ZINC FINISH

54045

179,00€

11.45	-	2	48
Kg	SUB	11	

CHROME FINISH

STEEL S2

CrV

216 PCS

54034



SPARE PARTS AVAILABLE









54045

























SPARE PARTS AVAILABLE



IT CONTAINS

	1/2" x14	13, 14, 15, 16, 17, 18, 19, 20, 21, 22, 24, 27, 30, 32mm
	3/8" x10	10, 11, 12, 13, 14, 15, 16, 17, 18, 19mm
	1/4" x13	4, 4.5, 5, 5.5, 6, 7, 8, 9, 10, 11, 12, 13, 14mm
	1/2" x5	16, 17, 18, 19, 22mm
	3/8" x6	10, 11, 12, 13, 14, 15mm
	1/4" x7	4, 5, 6, 7, 8, 9, 10mm
	1/2" x3	E20, E22, E24
	3/8" x6	E10, E11, E12, E14, E16, E18
	1/4" x5	E4, E5, E6, E7, E8
	T2 x3	1/2" - 3/8" - 1/4"
	1/2" x2	125, 250mm
	3/8" x1	125mm
	1/4" x2	50, 100mm
	x3	1/2" - 3/8" - 1/4"
	1/2" x1	converter 3/8" H x 1/2" M

	1/2" x1	8mm
	3/8" x1	8mm
	1/4" x1	6mm
	1/2" x2	16, 21mm
	3/8" x1	18mm
	1/2" x12	8, 9, 10, 11, 12, 13, 14, 15, 16, 17, 18, 19mm
	1/2" x7	1.27, 1.5, 2, 2.5, 3, 4, 5mm
	1/4" x1	
	1/4" x1	
	1/4" x1	
	1/2" x1	T70
	1/2" x1	14mm
	1/4"	x3 PH0, PH1, PH2
		x3 PZ0, PZ1, PZ2
		x4 3, 4, 5, 6mm
		x4 SL4, SL5.5, SL6.5, SL7
	x8	T8, T9, T10, T15, T20, T25, T27, T30
	x8	T8, T9, T10, T15, T20, T25, T27, T30

	8mm x4	7, 8, 10, 12mm
	6mm x6	2, 2.5, 3, 4, 5, 6mm
	8mm x3	SL8, SL10, SL12
	8mm x3	PH2, PH3, PH4
	8mm x3	PZ2, PZ3, PZ4
	8mm x5	T40, T45, T50, T55, T60
	6mm x3	T5, T6, T7
	8mm x5	T40, T45, T50, T55, T60
	6mm x1	T7
	8mm x4	M10, M11, M12, M13
	6mm x5	M5, M6, M7, M8, M9
	8mm x2	M10, M12
	6mm x3	M5, M6, M8
	8mm x1	TS50
	6mm x8	TS10, TS15, TS20, TS25, TS27, TS30, TS40, TS45
		x4 0, 1, 2, 3mm
		x3 6, 8, 10mm
	6mm x4	4, 6, 8, 10mm
		x3 1, 2, 3mm
		x4 1, 2, 3, 4mm
	6mm x1	1/4"

216 PIECES 12-POINT SOCKET AND RATCHET SPANNER SET

54250 188,00€

11.50	-	2	48
Kg	SUB	11	

STEEL S2

CrV

216 PCS



IT CONTAINS

	1/2"	x14	13, 14, 15, 16, 17, 18, 19, 20, 21, 22, 24, 27, 30, 32mm
	3/8"	x10	10, 11, 12, 13, 14, 15, 16, 17, 18, 19mm
	1/4"	x13	4, 4.5, 5, 5.5, 6, 7, 8, 9, 10, 11, 12, 13, 14mm
	1/2"	x5	16, 17, 18, 19, 22mm
	3/8"	x6	10, 11, 12, 13, 14, 15mm
	1/4"	x7	4, 5, 6, 7, 8, 9, 10mm
	1/2"	x3	E20, E22, E24
	3/8"	x6	E10, E11, E12, E14, E16, E18
	1/4"	x5	E4, E5, E6, E7, E8
	T2	x3	1/2" - 3/8" - 1/4"
	1/2"	x2	125, 250mm
	3/8"	x1	125mm
	1/4"	x2	50, 100mm
		x3	1/2" x 3/8" 4 x 1/2" M
	1/2"	x1	

	1/2"	x1	8mm
	3/8"	x1	8mm
	1/4"	x1	6mm
	1/2"	x2	16, 21mm
	3/8"	x1	18mm
	1/2"	x12	8, 9, 10, 11, 12, 13, 14, 15, 16, 17, 18, 19mm
	1/2"	x7	1.27, 1.5, 2, 2.5, 3, 4, 5mm
	1/4"	x1	
	1/4"	x1	
	1/4"	x1	
	1/2"	x1	T70
	1/2"	x1	14mm
		x3	PH0, PH1, PH2
		x3	PZ0, PZ1, PZ2
	1/4"	x4	3, 4, 5, 6mm
		x4	SL4, SL5.5, SL6.5, SL7
		x8	T8, T9, T10, T15, T20, T25, T27, T30
		x8	T8, T9, T10, T15, T20, T25, T27, T30

	8mm	x4	7, 8, 10, 12mm
	6mm	x6	2, 2.5, 3, 4, 5, 6mm
	8mm	x3	SL8, SL10, SL12
	8mm	x3	PH2, PH3, PH4
	8mm	x3	PZ2, PZ3, PZ4
	8mm	x5	T40, T45, T50, T55, T60
	6mm	x3	T5, T6, T7
	8mm	x5	T40, T45, T50, T55, T60
	6mm	x1	T7
	8mm	x4	M10, M11, M12, M13
	6mm	x5	M5, M6, M7, M8, M9
	8mm	x2	M10, M12
	6mm	x3	M5, M6, M8
	8mm	x1	TS50
	6mm	x8	TS10, TS15, TS20, TS25, TS27, TS30, TS40, TS45
		x4	0, 1, 2, 3mm
		x3	6, 8, 10mm
	6mm	x4	4, 6, 8, 10mm
		x3	1, 2, 3mm
		x4	1, 2, 3, 4mm
	6mm	x1	1/4"

132 PIECES HEXAGONAL TOOL SET

54082 188,00€

CrV

132
PCS

11.00	-	2	56
Kg	sub	ff	

**SPECIAL
AUTOMOTIVE**



SPARE PARTS
AVAILABLE

IT CONTAINS

	1/2"	x7	19,21, 22, 24, 27, 30, 32mm
	3/8"	x11	8, 9, 10, 11, 12, 13, 14, 15, 16, 17, 18, 19mm
	1/4"	x10	8, 9, 10, 11, 12, 13, 14, 15, 16, 17, 18, 19mm
	3/8"	x4	13, 14, 15, 17 mm
	1/4"	x4	8, 10, 12, 13mm
	3/8"	x6	E8, E10, E11, E14, E16, E20
	1/2"	x1	
	3/8"	x1	
	1/4"	x1	
	1/2"	x2	125, 250mm
	3/8"	x2	75, 150mm
	1/4"	x1	50mm
		x1	Ø14mm
		x1	3/8"(H)-1/2"(M)
		x1	3/8"(H)-1/2"(M)
		x1	3/8"(H)-1/4"(M)
	1/2"	x1	
	3/8"	x1	
	1/4"	x1	
	1/2"	x3	17, 19, 22mm
	1/4"	x1	6mm
		x1	
		x1	PH2x100
		x1	SL6x100
		x12	8, 9, 10, 11, 12, 13, 14, 15, 16, 17, 18, 19mm
		x1	
	1/2"	x1	H17
	1/2"	x1	21mm
	3/8"	x2	16, 18mm
	1/2"	x1	T52
	1/2"	x1	M16
		x2	5,5, 6,5mm
		x2	PH0, PH3
	3/8"	x2	PZ1, PZ3
		x4	4,5,6,8mm
		x6	T20, T30, T40, T45, T50, T55
		x3	4,5,6,5mm
		x3	PH1, PH2, PH3
	6mm	x3	PZ1, PZ2, PZ3
		x4	3,4,5,6
		x7	T10, T15, T20, T25, T27, T30, T40
		x9	1,5,2,2,5,3,4,5,6,8,10mm
		x1	
		x1	

179 PIECES TOOL SET HEXAGONAL SOCKETS

54035 149,00€

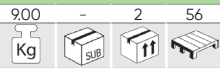

54046 150,00€

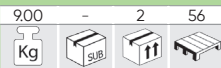

STEEL
S2

CrV

179
PCS

ZINC FINISH

CHROME FINISH

54035

SPARE PARTS AVAILABLE

54046

SPARE PARTS AVAILABLE



IT CONTAINS

	1/2" x17	10, 11, 12, 13, 14, 15, 16, 17, 18, 19, 20, 21, 22, 24, 27, 30, 32mm
	3/8" x10	10, 11, 12, 13, 14, 15, 16, 17, 18, 19mm
	1/4" x13	4, 4.5, 5, 5.5, 6, 7, 8, 9, 10, 11, 12, 13, 14mm
	1/2" x5	16, 17, 18, 19, 22mm
	3/8" x6	10, 11, 12, 13, 14, 15mm
	1/4" x7	4, 5, 6, 7, 8, 9, 10mm
	1/2" x2	E20, E24
	3/8" x6	E10, E11, E12, E14, E16, E18
	1/4" x5	E4, E5, E6, E7, E8
	T2 x3	1/2" - 3/8" - 1/4"
	1/2" x1	125mm
	3/8" x1	125mm
	1/4" x2	50, 100mm
	1/2" x1	250mm

	x3	1/2" - 3/8" - 1/4"
	1/2" x2	16, 21mm
	3/8" x1	18mm
	1/2" x1	8mm
	3/8" x1	8mm
	1/4" x1	6mm
	x7	1.27, 1.5, 2, 2.5, 3, 4, 5mm
	x1	1/4"
	x1	1/4"
	x3	PH1, PH2, PH3
	x3	PZ1, PZ2, PZ3
	1/4" x5	2, 3, 4, 5, 6mm
	x3	SL4, SL5.5, SL7
	x8	T8, T9, T10, T15, T20, T25, T27, T30
	x8	T8, T9, T10, T15, T20, T25, T27, T30

	x11	T5, T6, T7, T8, T9, T10, T15, T20, T25, T27, T30
	x9	T7, T10, T15, T20, T25, T27, T30, T40, T45
	x5	M5, M6, M7, M8, M9
	x3	M5, M6, M8
	x2	PH3, PH4
	x2	PZ3, PZ4
	x8	7, 8, 10, 12, 14mm
	x3	SL8, SL10, SL12
	x6	T40, T45, T50, T55, T60, T70
	x6	T40, T45, T50, T55, T60, T70

113 PIECES TOOL SET

12 POINT SOCKETS

54036 99,00€

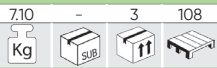

ZINC FINISH

54047 100,00€

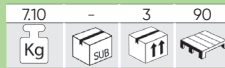

CHROME FINISH

STEEL
S2

CrV

113
PCS

54036



SPARE PARTS
AVAILABLE

54047



SPARE PARTS
AVAILABLE

STEEL
S2



IT CONTAINS

	1/2"	x17	10, 11, 12, 13, 14, 15, 16, 17, 18, 19, 20, 21, 22, 24, 27, 30, 32mm
	1/4"	x13	4, 4.5, 5, 5.5, 6, 7, 8, 9, 10, 11, 12, 13, 14mm
	1/2"	x5	14, 15, 17, 19, 22mm
	1/4"	x8	6, 7, 8, 9, 10, 11, 12, 13mm
	1/2"	x8	E10, E11, E12, E14, E16, E18, E20, E24
	1/4"	x5	E4, E5, E6, E7, E8
	T2	x2	1/2" - 1/4"
	1/2"	x2	125, 250mm
	1/4"	x2	50, 100mm

	x2	1/2" - 1/4"
	1/2"	x1 converter 3/8" H x 1/2" M
	1/2"	x1 8mm
	x5	7, 8, 10, 12, 14mm
	x3	SL8, SL10, SL12
	x2	PH3, PH4
	x2	PZ3, PZ4
	x5	T40, T45, T50, T55, T60
	x5	5, 6, 8, 10, 12mm

	1/2"	x2	16, 21mm
	x3	1.5, 2, 2.5mm	
	x1	1/4"	
	x1	1/4"	
	x2	PH1, PH2	
	x2	PZ1, PZ2	
	1/4"	x4	3, 4, 5, 6mm
	x3	SL4, SL5.5, SL6.5	
	x8	T8, T10, T15, T20, T25, T27, T30	

108 PIECES TOOL SET HEXAGONAL SOCKETS

54037 88,00€

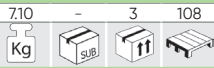

54048 89,00€

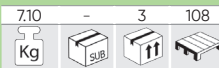

STEEL
S2

CrV

108
PCS

ZINC FINISH

CHROME FINISH



54048



SPARE PARTS
AVAILABLE

54037



SPARE PARTS
AVAILABLE



STEEL
S2

IT CONTAINS

	1/2" x17	10, 11, 12, 13, 14, 15, 16, 17, 18, 19, 20, 21, 22, 24, 27, 30, 32mm
	1/4" x13	4, 4.5, 5, 5.5, 6, 7, 8, 9, 10, 11, 12, 13, 14mm
	1/2" x5	14, 15, 17, 19, 22mm
	1/4" x8	6, 7, 8, 9, 10, 11, 12, 13mm
	1/2" x8	E10, E11, E12, E14, E16, E18, E20, E24
	1/4" x5	E4, E5, E6, E7, E8
	T2 x2	1/2" - 1/4"
	1/2" x2	125, 250mm
	1/4" x2	50, 100mm
	x2	1/2" - 1/4"
	1/2" x1	converter 3/8" H x 1/2" M

	1/2" x2	16, 21mm
	1/2" x1	8mm
	x3	1.5, 2, 2.5mm
	x1	1/4"
	x1	1/4"
	x2	PH3, PH4
	x2	PZ3, PZ4
	8mm x5	7, 8, 10, 12, 14mm
	x3	SL8, SL10, SL12
	x5	T40, T45, T50, T55, T60

	x2	PH1, PH2
	x2	PZ1, PZ2
	1/4" x4	3, 4, 5, 6mm
	x3	SL4, SL5.5, SL6.5
	x8	T8, T10, T15, T20, T25, T27, T30

94 PIECES TOOL SET HEXAGONAL SOCKETS

54038

88,00€

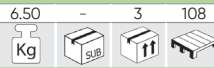

54049

88,00€

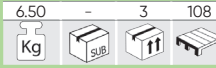

CrV

94
PCS

ZINC FINISH

CHROME FINISH

54049



SPARE PARTS
AVAILABLE

54038



SPARE PARTS
AVAILABLE



STEEL
S2



IT CONTAINS

	1/2" x18	10, 11, 12, 13, 14, 15, 16, 17, 18, 19, 20, 21, 22, 23, 24, 27, 30, 32mm
	1/4" x13	4, 4.5, 5, 5.5, 6, 7, 8, 9, 10, 11, 12, 13, 14mm
	1/2" x4	14, 15, 17, 19mm
	1/4" x8	6, 7, 8, 9, 10, 11, 12, 13mm
	72 x2	1/2" - 1/4"
	1/2" x2	125, 250mm
	1/4" x2	50, 100mm
	x2	1/2" - 1/4"
	1/2" x1	converter 3/8" H x 1/2" M

	1/2" x1	8mm
	x3	1.5, 2, 2.5mm
	1/2" x2	16, 21mm
	x2	PH3, PH4
	x2	PZ3, PZ4
	8mm x4	8, 10, 12, 14mm
	x3	SL8, SL10, SL12
	x4	T40, T45, T50, T55
	8mm x1	1/4"

	x1	1/4"
	x1	1/4"
	x1	1/4"
	x2	PH1, PH2
	x2	PZ1, PZ2
	1/4" x4	3, 4, 5, 6mm
	x3	SL4, SL5.5, SL7
	x6	T8, T10, T15, T20, T25, T30

303 PIECES TOOL SET HEXAGONAL SOCKETS

53212 149,00€

945 - 2 48
Kg SUB 11

CHROME FINISH



SPARE PARTS AVAILABLE



CrV 303 PCS

1/2" 1/4"



IT CONTAINS

	1/2"	x18	10, 11, 12, 13, 14, 15, 16, 17, 18, 19, 20, 21, 22, 23, 24, 27, 30, 32mm
	1/4"	x13	4, 4.5, 5, 5.5, 6, 7, 8, 9, 10, 11, 12, 13, 14mm
	12	x2	1/2" - 1/4"
	1/2"	x2	125, 250mm
	1/4"	x2	50, 100mm
	1/2"	x1	8mm
	1/4"	x1	6mm
	1/2"	x1	converter 3/8" H x 1/2" M
	1/2"	x2	16, 21mm
		x2	1/2" - 1/4"
		x1	1/4"
		x2	SL3.0 x 50mm, SL2.5 x 50mm
		x3	PH0x50mm, PH00x50mm, PH000x50mm
		x2	SL4.0x100mm, SL6.5x125mm
		x2	PH1x80mm, PH2x100mm

	6mm	x9	1.5, 2, 2.5, 3, 4, 5, 5.5, 6, 8mm
	6mm	x10	1/16, 5/64, 3/32, 7/64, 1/8, 9/64, 5/32, 3/16, 7/32, 1/4
	8mm	x4	H5.5, H6.5, H7, H8
	6mm	x6	5/64, 3/32, 7/64, 1/8, 9/64, 5/32
	6mm	x6	2, 2.5, 3, 4, 5, 6mm
	6mm	x9	SL3, SL4, SL4.5, SL5, SL5.5, SL6, SL6.5, SL7, SL8
	8mm	x4	SL5.5, SL6.5, SL7, SL8
	6mm	x10	PH0 (x2), PH1 (x2), PH2 (x4), PH3 (x2)
	8mm	x2	PH3, PH4
	6mm	x10	PZ0 (x2), PZ1 (x2), PZ2 (x4), PZ3 (x2)
	8mm	x2	PZ3, PZ4
	6mm	x10	T8, T10, T15, T20, T25, T27, T30, T35, T40, T45
	8mm	x8	T25, T27, T30, T35, T40 (x2), T45, T50
	6mm	x9	T8, T10, T15, T20, T25, T27, T30, T35, T40
	6mm	x3	5, 6, 8mm
	8mm	x4	5, 6, 8, 10mm

	6mm	x3	6, 8, 10
	6mm	x3	C1, C2, C3
	6mm	x4	1, 2, 3, 4
	6mm	x4	4, 6, 7, 10mm
	6mm	x4	S0, S1, S2, S3
		x7	1.27, 1.5, 2, 2.5, 3, 4, 5mm
		x13	1.5, 2, 2.5, 3, 3.2, 3.5, 4, 4.5, 4.8, 5, 5.5, 6, 6.5mm
		x1	
		x1	
		x10	
		x1	8"
		x1	3m
		x6	SL1.5, SL2, SL2.5, SL3, SL3.5, SL4
		x4	PH000, PH00, PH0, PH1
		x2	PZ0, PZ1
		x8	T5, T6, T7, T8, T9, T10, T15, T20
		x1	
		x23	
		x22	
		x10	
		x10	

2 PIECES HEX SOCKET SET CHROME FINISH

53647 96,00€

6.13 - 3 108
Kg SUB 11

CHROME FINISH



SPARE PARTS AVAILABLE



CrV 82 PCS

1/2" 1/4"



IT CONTAINS

	1/2"	x12	13, 14, 15, 16, 17, 18, 19, 22, 24, 27, 30, 32mm
	1/4"	x13	4, 4.5, 5, 5.5, 6, 7, 8, 9, 10, 11, 12, 13, 14mm
	12	x2	1/2" - 1/4"
	1/2"	x2	125, 250mm
	1/4"	x2	50, 100mm
	1/2"	x2	1/2" - 1/4"
	1/2"	x1	converter 3/8" H x 1/2" M

	1/2"	x2	16, 21mm
	1/2"	x1	8mm
		x9	8, 10, 11, 12, 13, 14, 17, 19, 22mm
		x1	150mm
		x1	1/4"
		x1	1/4"

	8mm	x2	PH3, PH4
	8mm	x2	PZ3, PZ4
	8mm	x4	8, 10, 12, 14mm
	8mm	x3	SL8, SL10, SL12
	8mm	x4	T40, T45, T50, T55
	8mm	x1	1/4"
	1/4"	x2	PH1, PH2
	1/4"	x2	PZ1, PZ2
	1/4"	x4	3, 4, 5, 6mm
	1/4"	x3	SL4, SL5.5, SL7
	1/4"	x6	T8, T10, T15, T20, T25, T30

74 PIECES TOOL SET 12 POINT SOCKETS

53074 78,00€

5,09 - 3 108



CHROME FINISH



SPARE PARTS AVAILABLE



74
PCS

CrV

1/2"

1/4"

IT CONTAINS

	1/2"	x18	10, 11, 12, 13, 14, 15, 16, 17, 18, 19, 20, 21, 22, 23, 24, 27, 30, 32mm
	1/4"	x10	4, 5, 5.5, 6, 7, 8, 10, 11, 12, 13mm
		x2	1/2" - 1/4"
	1/2"	x2	125, 250mm
	1/4"	x1	100mm
		x1	1/2"

	1/2"	x1	converter 3/8" H x 1/2" M
	1/2"	x1	21mm
		x3	1.5, 2, 2.5mm
		x1	1/4"
	1/4"	x1	6mm

	6mm	x5	PH0, PH1, PH2, PH3, PH4
		x5	PZ0, PZ1, PZ2, PZ3, PZ4
		x6	3, 4, 5, 6, 8, 10mm
		x5	SL3, SL4, SL5.5, SL6, SL7
		x8	T8, T10, T15, T20, T25, T27, T30, T40
		x4	4, 5, 6, 7mm

59 PIECES TOOL SET WITH 3/8"

12 POINT SOCKETS

54168 49,00€

2,60 - 10 180



SPARE PARTS AVAILABLE



59
PCS

CrV

3/8"

IT CONTAINS

	3/8"	x17	6, 7, 8, 9, 10, 11, 12, 13, 14, 15, 16, 17, 18, 19, 20, 21, 22mm
		x1	3/8"
	3/8"	x2	75, 150mm
	3/8"	x1	8mm
	3/8"	x1	8mm

		x1	3/8"
	8mm	x2	PH3, PH4
		x2	PZ3, PZ4
		x5	7, 8, 10, 12, 14mm
		x3	8, 10, 12mm
		x5	T40, T45, T50, T55, T60

		x1	1/4"
	1/4"	x2	PH1, PH2
		x2	PZ1, PZ2
		x4	3, 4, 5, 6mm
		x3	4, 5.5, 6.5mm
		x7	T8, T10, T15, T20, T25, T27, T30

56 PIECES TOOL SET HEXAGONAL SOCKETS

54105 33,00€

1,25 - 10 300



SPARE PARTS AVAILABLE



CrV

56
PCS

IT CONTAINS

	1/4"	x13	4, 4.5, 5, 5.5, 6, 7, 8, 9, 10, 11, 12, 13, 14mm
		x1	1/4"
	1/4"	x2	50, 100mm
		x1	1/4"
		x1	1/4"

	6mm	x4	SL4, SL5, SL6, SL7
		x3	M5, M6, M8
		x8	T8, T10, T15, T20, T25, T27, T30, T40
		x8	T8, T10, T15, T20, T25, T27, T30, T40
		x1	1/4"
	1/4"	x1	6mm
	6mm	x3	PH0, PH1, PH2
		x3	PZ0, PZ1, PZ2
		x6	3, 4, 5, 6, 7, 8mm
	6mm	x1	1/4"

130 PIECES BITS AND SOCKET SET WITH RATCHET

53953 29,00€

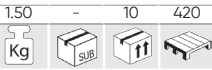

CrV 1/4" 130 PCS

ZINC FINISH

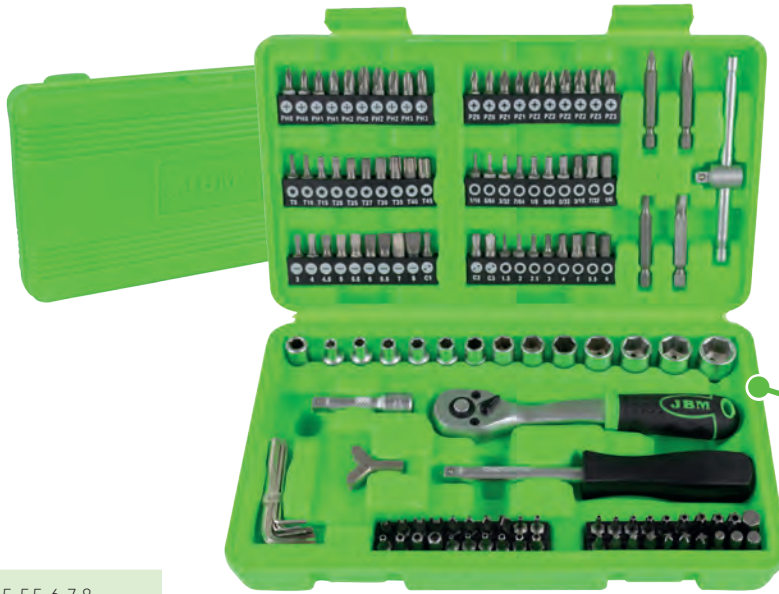
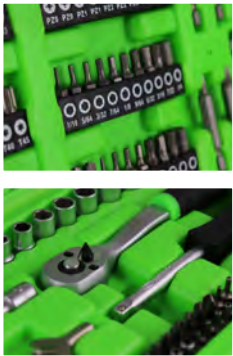

SPARE PARTS AVAILABLE



IN 10 UNITS DISPLAY CASE

IT CONTAINS

	1/4" x13	4, 4.5, 5, 5.5, 6, 7, 8, 9, 10, 11, 12, 13, 14mm
	x1	1/4"
	1/4" x1	50mm
	x1	1/4"
	1/4" x1	6mm
	x1	1/4"
	x1	1/4"
	1/4" x7	1.27, 1.5, 2, 2.5, 3, 4, 5mm

	25mm x10	1/16, 5/64, 3/32, 7/64, 1/8, 9/64, 5/32, 3/16, 7/32, 1/4
	x9	1.5, 2, 2.5, 3, 4, 5, 5.5, 6, 8mm
	25mm x6	5/64, 3/32, 7/64, 1/8, 9/64, 5/32
	x6	2, 2.5, 3, 4, 5, 6mm
	25mm x9	3, 4, 4.5, 5, 5.5, 6, 6.5, 7, 8mm
	50mm x2	4, 6mm
	25mm x10	PH0(x2), PH1(x2), PH2(x4), PH3(x2)
	50mm x2	PH1, PH2
	25mm x10	PZ0(x2), PZ1(x2), PZ2(x4), PZ3(x2)

	25mm x10	T8, T10, T15, T20, T25, T27, T30, T35, T40, T45
	25mm x9	T8, T10, T15, T20, T25, T27, T30, T35, T40
	25mm x3	M5, M6, M8
	25mm x3	6, 8, 10mm
	25mm x3	C1, C2, C3
	25mm x4	1, 2, 3, 4mm
	25mm x4	4, 6, 8, 10mm
	25mm x4	0, 1, 2, 3mm

59 PIECES SOCKET SET WITH 3/8" HEXAGONAL SOCKETS

51819 48,00€

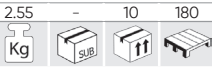

53219 49,00€

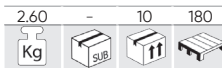

CrV 3/8" 59 PCS

ZINC FINISH

CHROME FINISH



SPARE PARTS AVAILABLE



SPARE PARTS AVAILABLE

IT CONTAINS

	3/8" x17	6, 7, 8, 9, 10, 11, 12, 13, 14, 15, 16, 17, 18, 19, 20, 21, 22mm
	x1	3/8"
	3/8" x2	75, 150mm
	3/8" x1	8mm
	3/8" x1	8mm

	x1	3/8"
	x2	PH3, PH4
	x2	PZ3, PZ4
	8mm x5	7, 8, 10, 12, 14mm
	x3	SL8, SL10, SL12
	x5	T40, T45, T50, T55, T60

	x1	1/4"
	x2	PH1, PH2
	x2	PZ1, PZ2
	1/4" x4	3, 4, 5, 6mm
	x3	SL4, SL5.5, SL6.5
	x7	T8, T10, T15, T20, T25, T27, T30

22 PIECES SOCKET SET 1/2"

54116 66,00€

3,95 - 4 96

Kg SUB 11

CrV 1/2" 22 PCS

SPARE PARTS AVAILABLE

12-POINT
IT CONTAINS

		1/2"	x17	10, 11, 12, 13, 14, 15, 16, 17, 18, 19, 21, 22, 24, 27, 30, 32mm
		1/2"	x1	125, 250mm
		1/2"	x2	125, 250mm
		1/2"	x1	
		1/2"	x1	3/8"(H), 1/2"(M)

46 PIECES HEX SOCKET SET 1/4"

54109 34,00€

1,40 - 10 360

Kg SUB 11

CrV 1/4" 46 PCS

SPARE PARTS AVAILABLE

IT CONTAINS

		1/4"	x13	4, 4.5, 5, 5.5, 6, 7, 8, 9, 10, 11, 12, 13, 14mm
		1/4"	x1	
		1/4"	x1	1/4"
		1/4"	x1	1/4"
		2"/4"	x2	
			x4	1,27, 1,5, 2,0, 2,5mm
			x1	
			x1	1/4"

56 PIECES 12-POINT SOCKET SET

53102 36,00€

1,28 - 10 270

Kg SUB 11

1/4" CrV 56 PCS

SPARE PARTS AVAILABLE

IT CONTAINS

54140 36,00€

1,28 - 10 300

Kg SUB 11

1/4" CrV 56 PCS

SPARE PARTS AVAILABLE

IT CONTAINS

CHROME FINISH

		1/4"	x13	4, 4.5, 5, 5.5, 6, 7, 8, 9, 10, 11, 12, 13, 14mm
		1/4"	x1	1/4"
		1/4"	x2	50, 100mm
			x1	1/4"
			x1	1/4"

		1/4"	x1	
		1/4"	x1	6mm
			x3	PH0, PH1, PH2
		6mm	x3	PZ0, PZ1, PZ2
			x6	3, 4, 5, 6, 7, 8mm
		6mm	x1	1/4"

			x4	SL4, SL5, SL6, SL7
		6mm	x3	M5, M6, M8
			x8	T8, T10, T15, T20, T25, T27, T30, T40
			x8	T8, T10, T15, T20, T25, T27, T30, T40

VAT not included

37 PIECES SOCKET SET SAE

54106 89,00€

4.70 - 3 108
Kg SUB



IT CONTAINS

	1/2" x17	5/16", 3/8", 7/16", 1/2", 9/16", 19/32", 5/8", 11/16", 3/4", 13/16", 7/8", 15/16", 1", 1-1/16", 1-1/8", 1-3/16", 1-1/4", 3/16", 7/32", 1/4", 9/32", 5/16", 11/32", 3/8", 7/16"
	1/4" x8	
	x2	53076 1/2" - 1/4"
	1/2" x2	5", 10"
	1/4" x1	3"
	x1	1/2"
	x1	1/4"
	x2	1/2" - 1/4"
	x1	1/4"

37 PCS

1/4"

1/2"

CrV



22 PIECES SOCKET SET 1/2" HEX.

54108 66,00€

3.95 - 4 128
Kg SUB



IT CONTAINS

	1/2" x16	10, 11, 12, 13, 14, 15, 16, 17, 18, 19, 21, 22, 24, 27, 30, 32mm
	1/2" x1	
	1/2" x2	75, 125mm
	x1	3/8"(H)-1/2"(M)

22 PCS

1/2"

CrV



61 PIECES 1/4" & 1/2" 12-POINT SPLINE SOCKET SET ZINC FINISH

52722 87,00€

4.63 - 4 60
Kg SUB

1/2" 1/4"

ZINC FINISH



53108 92,00€

4.83 - 3 90
Kg SUB

1/2" 1/4" CrV 61 PCS

CHROME FINISH



- Useful for:

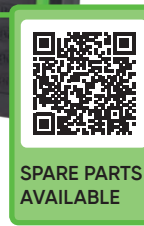

IT CONTAINS

	1/2" x11	14, 15, 16, 17, 18, 19, 22, 24, 27, 30, 32mm
	1/4" x12	4, 4.5, 5, 5.5, 6, 7, 8, 9, 10, 11, 12, 13mm
	x2	53076 1/2" - 1/4"
	1/2" x2	125, 250mm
	1/4" x2	50, 100mm
	x2	1/2" - 1/4"
	x1	converter 3/8" H x 1/2" M
	1/2" x2	16, 21mm
	1/4" x1	6mm
	x3	1.5, 2, 2.5mm
	x1	1/4"
	x1	1/4"

	x3	PH1, PH2, PH3
	x3	PZ1, PZ2, PZ3
	x5	3, 4, 5, 6, 8mm
	x3	SL4, SL5.5, SL7
	x5	T10, T15, T20, T25, T30
	x1	1/4"

77 PIECES TOOL CASE

54258 58,00€

7.50 - 4 -
Kg SUB



IT CONTAINS

	x5	PH0, PH1, PH2, PH2, PH3
	x5	PZ0, PZ1, PZ2, PZ2, PZ3
	x5	3, 4, 5, 5.5, 6mm
	x5	T10, T15, T20, T25, T30
	x4	6x7mm, 8x9mm, 10x11mm, 12x13mm
	x9	1.5, 2, 2.5, 3, 4, 5, 6, 8, 10mm
	x10	
	x10	

	x1	
	x1	
	x1	
	x1	
	x1	
	x1	
	x1	
	x3	PH2X100, PH00X50, PH00X50, SL6X100
	x3	SL2.5X50, SL3.0X50

CrV 77 PCS

72 PIECES HEX SOCKET SET ZINC FINISH

51818

95,00€

715	-	3	60

ZINC FINISH

53106

99,00€

720	-	3	60

CHROME FINISH



CrV

72
PCS

1/2"

1/4"



53106



SPARE PARTS
AVAILABLE

51818



SPARE PARTS
AVAILABLE

IT CONTAINS

	1/2"	x13	10, 11, 12, 13, 14, 15, 17, 19, 22, 24, 27, 30, 32mm		x2	1/2" - 1/4"		x1		
	1/4"	x10	4, 5, 6, 7, 8, 9, 10, 11, 12, 13mm		x2	16, 21mm		x1	300gr	
	1/4"	x5	5, 6, 7, 8, 9mm		x1	6mm		x1		
	ref. 53106	72	x2	1/2", 1/4"		x3	1.5, 2, 2.5mm		x1	
	ref. 51818	24	x2	1/2", 1/4"		x1	1/4"		x1	
	1/2"	x1	125mm		x2	PH6x40mm, PH6x100mm		x4	SL3, SL4, SL5, SL6	
	1/4"	x1	75mm		x3	SL6x40mm, SL6x100mm, SL8x200mm		x3	PH1, PH2, PH3	
					x7	T10, T15, T20, T25, T27, T30, T40		x7		

41 PIECES HEX SOCKET SET ZINC FINISH

52713

89,00€

6,30	-	4	96

ZINC FINISH



CrV

41
PCS

1/2"



SPARE PARTS
AVAILABLE

IT CONTAINS

	1/2"	x11	10, 12, 13, 14, 15, 17, 19, 22, 24, 27, 30mm		x1	6"
	1/2"	x2	16, 21mm		x1	20x200mm
	24	x1	1/2"		x1	6-24V, 110mm
	1/2"	x1	125mm		x1	8"
	1/2"	x1			x2	8x10, 12x13mm
	1/2"	x1	converter 3/8" H x 1/2" M		x1	8x10mm
	1/2"	x8	7, 8, 10, 12, 13, 14, 17, 19mm		x1	75x300mm
		x4	6, 8, 10, 12mm		x1	300gr
	+	x1	PH2x100mm		x1	6x150mm
	-	x1	SL6x100mm			

VAT not included

JBM / www.jbmcamp.com

19

ALUMINIUM TOOL CASES

159 PIECES TOOL SET IN ALUMINIUM CASE ZINC FINISH

53159 289,00€

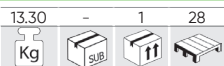

CrV

1/2"

1/4"

159 PCS

ZINC FINISH



IT CONTAINS



	1/2"	x14	14, 15, 16, 17, 18, 19, 20, 21, 22, 23, 24, 27, 30, 32mm
	1/4"	x10	4, 5, 6, 7, 8, 9, 10, 11, 12, 13mm
	12	x2	1/4" - 1/2"
	1/2"	x2	50, 100mm
	1/4"	x2	125, 250mm
	1/4"	x1	150mm
		x2	1/4" - 1/2"
	1/2"	x1	converter 3/8" H x 1/2" M
		x2	1/4" - 1/2"
	1/4"	x1	250mm
	1/4"	x1	110mm
	1/2"	x2	16, 21mm
		x1	1/4"

	x9	8, 10, 11, 12, 13, 15, 17, 19, 22mm	
	x9	1.5, 2, 2.5, 3, 4, 5, 6, 8, 10mm	
	x1	100-250V	
	x1		
	+	x2	PH1x80, PH2x10mm
	⊖	x4	SL3x75, SL4x100, SL6.5x125, SL8x150mm
	+	x1	PH00x50mm
	⊖	x1	SL2.5x50mm
	x1	250mm	
	x1	160mm	
	x1	180mm	
	x1	160mm	
	x1	200mm	
	x1	7" (180mm)	
	x1	220mm	
	x1	160mm	

	x1	
	x6	1.5mm
	x1	
	x1	300gr
	x1	3m
	x1	200mm
	x5	
	x1	18mm
	x10	
	x40	6.35mm
	x15	8mm

ALUMINIUM TOOL CASE

135 PIECES HEX SOCKET SET IN ALUMINIUM CASE

53928 278,00€

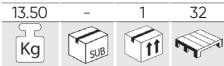

1/2" 1/4" 135 PCS
CrV



SPARE PARTS AVAILABLE



IT CONTAINS



	x1	250mm
	x1	180mm
	x1	180mm
	x1	200mm
	x1	160mm
	x1	200mm
	x1	
	x3	
	x1	18mm

	1/2"	x10	10, 11, 12, 13, 14, 15, 17, 19, 22, 24mm
	1/4"	x9	4, 5, 6, 7, 8, 9, 10, 11, 12mm
	72	x2	1/2" - 1/4"
	1/2"	x2	125, 250mm
	1/4"	x2	50, 100mm
		x2	1/2" - 1/4"
	1/2"	x1	converter 3/8" H x 1/2" M
		x1	1/4"
	1/4"	x1	6mm
	1/2"	x2	16, 21mm
		x9	8, 10, 11, 12, 13, 14, 17, 19, 22mm
		x1	150mm

	x1	
	x1	
	x1	100-250v
	x1	
	x1	300gr.
	x1	
	x1	5m

	x1	
	x3	SL1.5, SL2, SL3
	x4	PH000, PH00, PH0, PH1
	x8	T4, T5, T6, T7, T8, T10, T15, T20
	x4	TS0.8, TS1.2, TS1.5, TS2.0
	x1	H2.0
	x9	1.5, 2, 2.5, 3, 4, 5, 6, 8, 10mm
	x2	PH1x80mm, PH2x100mm
	x4	SL3.0x75mm, SL4.0x100mm, SL6.5x125mm, 8x150mm
	x5	

	x1	
	x1	6.35mm
	x4	PH1, PH2, PH2, PH3
	x4	PZ1, PZ2, PZ2, PZ3
	x4	SL3, SL4, SL5, SL6
	x4	H3, H4, H5, H6
	x6	T10, T15, T20, T25, T27, T30, T40
	x7	TT10, TT15, TT20, TT25, TT27, TT30, TT40

ALUMINIUM TOOL CASE

108 PIECES TOOL SET IN ALUMINIUM CASE 1/2" SOCKETS

53444 195,00€

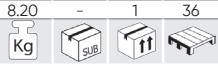

CrV

108
PCS

1/2"

3/8"

1/4"

ZINC FINISH



SPARE PARTS
AVAILABLE

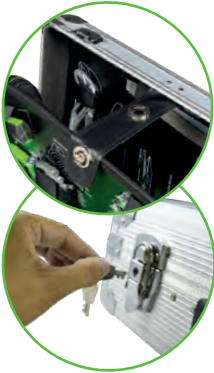

IT CONTAINS



	1/4"	x8	4, 4.5, 5, 5.5, 6, 7, 8, 9mm
	3/8"	x9	10, 11, 12, 13, 14, 15, 17, 18, 19mm
	1/2"	x1	72
	3/8"	x2	75, 150mm
	1/2"	x1	converter 3/8" H x 1/4" M
	1/4"	x1	25mmL
	1/4"	x1	

	3/8"	x1	16mm
		x8	6x7, 8x9, 10x11, 12x13, 14x15, 16x17, 18x19, 20x22mm
		x9	1.5, 2, 2.5, 3, 4, 5, 6, 8, 10mm
	+	x2	PH1x80, PH2x100mm
	-	x4	SL3.5x75, SL4x100, SL6.5x125, SL8x150mm
	+	x1	PH00x50mm
	-	x1	SL2.5x50mm

	x1	100-250V		x1	
	x1	250mm		x6	1.5mm
	x1	180mm		x1	300gr
	x1	160mm		x31	
	x1	160mm		x1	
	x1	220mm		x1	7"
	x1	18mm		x1	3m
	x10				

22 PIECES 1" HEXAGONAL SOCKET SET IN METAL CASE

51616 378,00€

34.60	-	1	24
Kg	SUB	11	11



51855 378,00€

33.70	-	1	24
Kg	SUB	11	11



CrV 1" 22 PCS
ZINC FINISH



METALLIC BOX

IT CONTAINS

	1"	x17	36, 38, 41, 46, 50, 54, 55, 58, 60, 63, 65, 67, 70, 71, 75, 77, 80mm
	1"	x1	650mm
	1"	x2	205, 410mm
	x1 1"		x1 1"

51616

SPARE PARTS AVAILABLE

51855

SPARE PARTS AVAILABLE

21 PIECES 3/4" HEX SOCKET SET

53727 198,00€

14.65	-	1	40
Kg	SUB	11	11



CrV 3/4" 21 PCS
ZINC FINISH

53728 198,00€

14.30	-	1	40
Kg	SUB	11	11



IT CONTAINS

	3/4"	x16	19, 21, 22, 23, 24, 26, 27, 29, 30, 32, 35, 36, 38, 41, 46, 50mm
	3/4"	x1	495mm
	3/4"	x3	100, 200, 400mm
	3/4"	x1	445mm



53728

SPARE PARTS AVAILABLE

53727

SPARE PARTS AVAILABLE

39 PIECES GO-THROUGH SOCKET SET

52418 164,00€

3.61	-	5	100
Kg	SUB	11	11



CrV 39 PCS
CHROME FINISH

IT CONTAINS

	13mm	x12	4, 4.5, 5, 5.5, 6, 7, 8, 9, 10, 11, 12, 13mm
	19mm	x10	10, 11, 12, 13, 14, 15, 16, 17, 18, 19mm
	22mm	x5	20, 21, 22, 23, 24mm
	22mm - 1/2"	x3	27, 30, 32mm
		x3	13, 19, 22mm
	1/4"	x1	13mm
	3/8"	x1	19mm
	1/2"	x1	22mm
		x3	13, 19, 22mm



14 PIECES GO-THROUGH SOCKET SET ZINC FINISH

54090 56,00€

14
PCS

2.00	-	10	240
Kg	SUB	11	11



IT CONTAINS

	x11	13, 14, 15, 16, 17, 18, 19, 21, 22, 24, 27mm
	x1	75mmL
	x1	1/2"
	x1	go-through

17 PIECES GO-THROUGH SOCKET SET

50623 60,00€

17
PCS

0.63	-	10	320
Kg	SUB	11	11



CrV

1/4"

CHROME FINISH



LOW PROFILE



IT CONTAINS

	13mm	x13	4, 4.5, 5, 5.5, 6, 7, 8, 9, 10, 11, 12, 13, 14mm
	13mm	x1	75mm
		x1	1/4"
	13mm	x1	145mm



6 PIECES 1/2" EXTRA LONG E-STAR TORX TYPE SOCKET SET

53915 65,00€

CrV

1/2"

6
PCS

2.10	-	10	240
Kg	SUB	11	11

ZINC FINISH

IT CONTAINS

	1/2"	x6	E10, E12, E14, E16, E18, E20
--	------	----	------------------------------

E12 Socket for BMW cylinder head:
- M42 engine, 1.8L, 4 cylinders, 16V, model 318 is from 1989
- M50 engine, 2.0L, 2.5L, 6 cylinders, 24V, model 520i, 525i from 1991



SOCKET HEAD WITH BLACK FINISH



28 PIECES SOCKET SET TORX

51930 39,00€

CrV

1/2"

3/8"

1/4"

28
PCS

2.12	-	10	240
Kg	SUB	11	11

IT CONTAINS

	1/4"	x5	25mm	E4, E5, E6, E7, E8
	3/8"	x5	28mm	E10, E11, E12, E14, E16
	1/2"	x4	38mm	E18, E20, E22, E24
	1/4"	x5	50mm	E4, E5, E6, E7, E8
	3/8"	x5	63mm	E10, E11, E12, E14, E16
	1/2"	x4	76mm	E18, E20, E22, E24

51930



SPARE PARTS AVAILABLE



ZINC FINISH

54141 42,00€

CrV

1/2"

3/8"

1/4"

28
PCS

2.15	-	10	240
Kg	SUB	11	11



	1/4"	x5	25mm	E4, E5, E6, E7, E8
	3/8"	x5	28mm	E10, E11, E12, E14, E16
	1/2"	x4	38mm	E18, E20, E22, E24
	1/4"	x5	50mm	E4, E5, E6, E7, E8
	3/8"	x5	63mm	E10, E11, E12, E14, E16
	1/2"	x4	76mm	E18, E20, E22, E24



12 PIECES BIT SOCKET SET 1/2" TORX

51261 36,00€

1.62	-	10	360

ZINC FINISH



CHROME FINISH

	1/2"	x6	T20, T25, T30, T40, T45, T50
		x1	T55
		x5	T60, T70, T80, T90, T100

SPARE PARTS AVAILABLE

12 PIECES BIT SOCKET SET 1/2" 12 POINT

51384 34,00€

1.62	-	10	360

ZINC FINISH



CHROME FINISH

IT CONTAINS

	1/2"	x6	M4, M5, M6, M7, M8, M9
		x1	M10
		x5	M12, M14, M16, M18, M20

12 PIECES BIT SOCKET SET 1/2" HEXAGONAL

51260 37,00€

1.92	-	10	360

ZINC FINISH

51260

SPARE PARTS AVAILABLE



CrV 1/2" 12 PCS

53105 37,00€

2.05	-	10	240

CHROME FINISH

IT CONTAINS

	1/2"	x6	H5, H6, H7, H8, H10, H12
		x1	H14
		x5	H16, H17, H18, H19, H22

SET OF 6 1/2" PIECES TORX TAMPER-PROOF BIT SOCKETS

51410 36,00€

0.38	5	20	500



T55, T60, T70, T80, T90, T100

1/2" CrV 6 PCS

SET OF 6 PIECES 1/2" TAMPER-PROOF 12-POINT XZN BIT SOCKETS

51409 36,00€

0.35	5	20	-



M10, M12, M14, M16, M18, M20

1/2" CrV 6 PCS

VAT not included

BIT SOCKET SET 12-POINT AND RIBE

52603 74,00€



26
PCS

4.07	-	4	128
Kg	sub	ff	



IT CONTAINS

	x8	M5, M6, M8, M9, M10, M12, M14, M16
	x7	M5, M6, M8, M9, M10, M12, M14
	x7	M5, M6, M8, M9, M10, M12, M14
	x4	M8, M10, M12, M14



SPARE PARTS AVAILABLE

52606 88,00€



32
PCS

5.05	-	4	128
Kg	sub	ff	



IT CONTAINS

	x9	M5, M6, M7, M8, M9, M10, M12, M13, M14
	x9	M5, M6, M7, M8, M9, M10, M12, M13, M14
	x7	M7, M8, M9, M10, M12, M13, M14
	x7	M7, M8, M9, M10, M12, M13, M14



SPARE PARTS AVAILABLE

BIT SOCKET SET HEXAGONAL AND TORX

52604 78,00€



30
PCS

4.62	-	4	144
Kg	sub	ff	



IT CONTAINS

	x9	5, 6, 7, 8, 10, 12, 14, 17, 19mm
	x8	5, 6, 7, 8, 10, 11, 12, 13mm
	x7	5, 6, 7, 8, 10, 12, 14mm
	x6	5, 6, 7, 8, 10, 12mm



SPARE PARTS AVAILABLE

52605 76,00€



32
PCS

4.60	-	4	144
Kg	sub	ff	



IT CONTAINS

	x10	T20, T25, T27, T30, T40, T45, T50, T55, T60, T70
	x10	T20, T25, T27, T30, T40, T45, T50, T55, T60, T70
	x6	T40, T45, T50, T55, T60, T70
	x6	T40, T45, T50, T55, T60, T70



SPARE PARTS AVAILABLE

55 PIECES MECHANICS BIT SET HEAVY DUTY

52753 107,00€

2,96 - 4 184



S-2 3/8" 1/2" 55 PCS

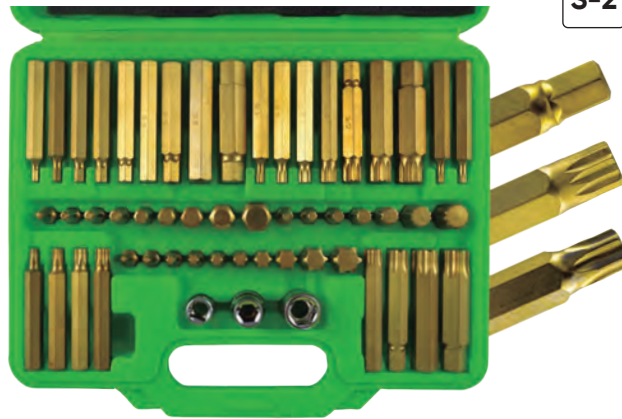

IT CONTAINS

	3/8"	x1	10mm
	1/2"	x2	10, 14mm
	30mm	x9	4, 5, 6, 7, 8, 10, 12, 14, 16mm - ISO 2136
	75mm	x9	4, 5, 6, 7, 8, 10, 12, 14, 16mm - ISO 2136
	30mm	x10	T20, T25, T30, T40, T45, T50, T55, T60, T70, T80 - DIN 2325
	75mm	x10	T20, T25, T30, T40, T45, T50, T55, T60, T70, T80 - DIN 2325
	30mm	x7	M5, M6, M8, M10, M12, M14, M16 - DIN 2325
	75mm	x7	M5, M6, M8, M10, M12, M14, M16 - DIN 2325

42 PIECES MECHANICS BIT SET HEXAGONAL, 12 POINT, TORX AND RIBE

50983 48,00€

1,77 - 5 275



IT CONTAINS

	3/8"	x1	10mm
	1/2"	x1	10mm
	30mm	x7	4, 5, 6, 7, 8, 10, 12mm
	75mm	x7	4, 5, 6, 7, 8, 10, 12mm
	30mm	x8	T20, T25, T30, T40, T45, T50, T55, T60
	75mm	x8	T20, T25, T30, T40, T45, T50, T55, T60
	30mm	x5	M5, M6, M8, M10, M12
	75mm	x5	M5, M6, M8, M10, M12



50985 59,00€

1,74 - 5 275



TAMPER PROOF



IT CONTAINS

	3/8"	x1	10mm
	1/2"	x1	10mm
	30mm	x7	4, 5, 6, 7, 8, 10, 12mm
	75mm	x7	4, 5, 6, 7, 8, 10, 12mm
	30mm	x8	T20, T25, T30, T40, T45, T50, T55, T60
	75mm	x8	T20, T25, T30, T40, T45, T50, T55, T60
	30mm	x5	M5, M6, M8, M10, M12
	75mm	x5	M5, M6, M8, M10, M12



75 PIECES MECHANICS BIT SET HEXAGONAL, 12 POINT, TORX, TORX TAMPER-PROOF AND RIBE

52550 92,00€

3,61 - 4 96



S-2 3/8" 1/2" 75 PCS



IT CONTAINS

	3/8"	x1	10mm
	1/2"	x2	10mm
	30mm	x7	4, 5, 6, 7, 8, 10, 12mm
	75mm	x7	4, 5, 6, 7, 8, 10, 12mm
	30mm	x8	T20, T25, T30, T40, T45, T50, T55, T60
	75mm	x8	T20, T25, T30, T40, T45, T50, T55, T60
	30mm	x5	M5, M6, M8, M10, M12
	75mm	x5	M5, M6, M8, M10, M12
	30mm	x8	M5, M6, M7, M8, M9, M10, M12, M14
	75mm	x5	M5, M6, M8, M10, M12
	30mm	x8	T20, T25, T30, T40, T45, T50, T55, T60
	75mm	x8	T20, T25, T30, T40, T45, T50, T55, T60

208 PIECES BIT SET

53574 47,00€

2,29	-	6	216
Kg	Sub	11	

CrV 208 PCS



IT CONTAINS

25mmL x12	1,5, 2, 2,5, 3, 3,5, 4, 4,5, 5, 5,5, 6, 7, 8mm	25mmL x4	4, 6, 8, 10mm
x10	1/16, 5/64, 3/32, 7/64, 1/8, 9/64, 5/32, 3/16, 7/32, 1/4	50mmL x4	4, 6, 8, 10mm
50mmL x5	2,5, 3, 4, 5, 6mm	25mmL x4	1, 2, 3, 4mm
75mmL x5	2,5, 3, 4, 5, 6mm	50mmL x4	1, 2, 3, 4mm
25mmL x18	PH00, PH0, PH1(x5), PH2(x5), PH3(x5), PH4	25mmL x6	2, 2,5, 3, 4, 5, 6mm
50mmL x3	PH1, PH2, PH3	25mmL x6	5/64, 3/32, 7/64, 1/8, 9/64, 5/32
75mmL x3	PH1, PH2, PH3	25mmL x13	T5, 6, 7, 8, 9, 10, 15, 20, 25, 27, 30, 40, 45
25mmL x17	PZ00, PZ0, PZ1(x5), PZ2(x5), PZ3(x4), PZ4	25mmL x3	1, 2, 3mm
50mmL x3	PZ1, PZ2, PZ3	25mmL x4	0, 1, 2, 3mm
75mmL x3	PZ1, PZ2, PZ3	25mmL x3	M5, M6, M8
25mmL x14	T5, T6, T7, T8, T9, T10, T15, T20, T25, T27, T30, T35, T40, T45	25mmL x9	TS10, TS15, TS20, TS25, TS27, TS30, TS40, TS45, TS50, SL2, SL2.5, SL3, SL3.5, SL4, SL4.5, SL5, SL5.5, SL6, SL6.5, SL7, SL8
50mmL x7	T10, T15, T20, T25, T27, T30, T40	25mmL x12	
75mmL x7	T10, T15, T20, T25, T27, T30, T40		
25mmL x3	6, 8, 10mm		
50mmL x3	6, 8, 10mm		

mm	x10	4, 5, 6, 7, 8, 9, 10, 11, 12, 13
"	x10	5/32, 3/16, 7/32, 1/4, 9/32, 5/16, 11/32, 3/8, 7/16, 1/2
6mm	x1	1/4" Converter
	x1	

85 PIECES SCREWDRIVER BIT SET

52539 59,00€

1,90	-	5	128
Kg	Sub	11	

ALLEN 8 CrV 85 PCS

IT CONTAINS

x2	PH3, PH4
x2	PZ3, PZ4
8mm x5	7, 8, 10, 12, 14mm
x3	SL8, SL10, SL12
x5	T40, T45, T50, T55, T60



SPARE PARTS AVAILABLE

90 PIECES SCREWDRIVER BIT SOCKETS SET

52538 62,00€

2,07	-	16	128
Kg	Sub	11	

CrV 1/4" 90 PCS

IT CONTAINS

x2	PH1, PH2
x2	PZ1, PZ2
1/4" x5	3, 4, 5, 6mm
x3	SL4, SL5.5, SL6.5
x5	T8, T10, T15, T20, T25, T27, T30



SPARE PARTS AVAILABLE

6 PIECES SOCKET ADAPTOR SET

51333 18,00€

0,52	5	40	960
Kg	Sub	11	

CrV 6 PCS

ZINC FINISH

M	H
1/2"	3/4"
3/8"	1/2"
1/4"	3/8"
3/8"	1/4"
1/2"	3/8"
3/4"	1/2"



SPARE PARTS AVAILABLE

REF.	DESCRIPTION	Kg	€
11360	1/4H - 3/8M	0,02	2,60€
11361	1/4M - 3/8H	0,05	3,20€
11362	3/8H - 1/2M	0,13	5,20€
11363	1/4H - 3/8M	0,05	3,90€
11364	1/2H - 3/8M	0,05	4,50€
11365	3/4H - 1/2M	0,14	9,40€



6 PIECES IMPACT SOCKET ADAPTOR SET

53743 39,70€

0,80	5	20	960
Kg	Sub	11	

CrMo 6 PCS

M →
F →



SPARE PARTS AVAILABLE

REF.	mm	Kg	Sub	11	€
14749	1/4" F - 3/8" M	-	20	100	2,00€
14750	3/8" F - 1/4" M	-	20	100	2,00€
14751	3/8" F - 1/2" M	-	20	100	4,00€
14752	1/2" F - 3/8" M	-	10	100	4,00€

M	H
3/4"	1/2"
1/2"	3/4"
3/8"	1/4"
1/4"	3/8"
1/2"	3/8"
3/8"	1/2"

38 PIECES MINI RATHCET SET 1/4"

53156 26,20€

0,48 6 36 1008
Kg SUB ff



52198 37,70€

0,45 6 36 1800
Kg SUB ff



CrV 1/4" 38 PCS

IT CONTAINS

	1/4"	x11	4, 4.5, 5, 6, 7, 8, 9, 10, 11, 12, 13mm
	T2	x1	1/4"
		x2	PH3, PH4
		x2	PZ3, PZ4
		x5	4, 5, 6, 7, 8mm
	6mm	x3	SL6, SL8, SL10
		x2	T8, T9, T10, T15, T20, T25, T30, T40
		x4	M5, M6, M9, M10
		x1	1/4"

10 PIECES SOCKET SET 1/2"

52714 15,70€

0,65 4 24 576
Kg SUB ff



PRESENTED
IN METALLIC GUIDE



SPARE PARTS
AVAILABLE

52716 15,90€

0,61 4 24 576
Kg SUB ff



10, 11, 12, 13, 14, 15,
16, 17, 18, 19mm

1/2" 10 PCS



PRESENTED
IN METALLIC GUIDE



SPARE PARTS
AVAILABLE

13 PIECES SOCKET SET 1/4"

52715 10,00€

0,35 6 36 1152
Kg SUB ff



PRESENTED
IN METALLIC GUIDE



SPARE PARTS
AVAILABLE

52717 11,00€

0,27 6 36 1152
Kg SUB ff



4, 4.5, 5, 5.5, 6, 7, 8, 9,
10, 11, 12, 13, 14mm

1/4" 13 PCS



PRESENTED
IN METALLIC GUIDE



SPARE PARTS
AVAILABLE

18 PIECES BIT SOCKET SET 1/4"

52909 12,50€

0,35 8 32 1500
Kg SUB ff

S-2 1/4" 18 PCS

CrV



PRESENTED
IN METALLIC GUIDE



SPARE PARTS
AVAILABLE

30 PIECES BIT SOCKET SET 1/4"

52908 17,00€

0,60 8 32 500
Kg SUB ff

S-2 1/4" 30 PCS

CrV



PRESENTED
IN METALLIC GUIDE



SPARE PARTS
AVAILABLE

IT CONTAINS

	x2	PH1, PH2
	1/4"	x2 PZ1, PZ2
	x4	3, 4, 5, 6mm
	1/4"	x3 SL4, SL5.5, SL6.5
	x7	T8, T10, T15, T20, T25, T27, T30

IT CONTAINS

	x3	PH0, PH1, PH2
	1/4"	x3 PZ0, PZ1, PZ2
	x4	3, 4, 5, 6mm
	1/4"	x4 SL4, SL5.5, SL6.5, SL7
	1/4"	x8 T8, T9, T10, T15, T20, T25, T27, T30
	1/4"	x8 T8, T9, T10, T15, T20, T25, T27, T30

7 PIECES BIT SOCKET SET 3/8" - 1/2" TORX

53084 24,00€

0.60	5	20	880
Kg	Sub	ff	

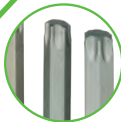

1/2" 3/8" 7 PCS

3/8": T30, T40, T45, T50
1/2": T55, T60, T70

CrV



SPARE PARTS AVAILABLE



PRESENTED IN METALLIC GUIDE

7 PIECES BIT SOCKET SET 1/4" TORX TAMPER-PROOF

53127 12,00€

0.15	5	100	1800
Kg	Sub	ff	



CrV 1/4" 7 PCS

T10, T15, T20, T25, T30, T40, T45



SPARE PARTS AVAILABLE



PRESENTED IN METALLIC GUIDE

7 PIECES BIT SOCKET SET TS 5-POINT TAMPER PROOF

51746 12,00€

0.20	5	75	1050
Kg	Sub	ff	

TS10, TS15, TS20, TS25, TS30, TS40, TS45



CrV 1/4" 7 PCS

PRESENTED IN METALLIC GUIDE



7 PIECES BIT SOCKET SET RIBE, HEXAGONAL AND 12 POINT

50980 22,00€

0.76	5	20	300
Kg	Sub	ff	



1/2" 100mm: M12, M13, M14
3/8" 90mm: M6, M7, M8, M10

50982 22,00€

0.46	6	36	1080
Kg	Sub	ff	



3/8" 100mm HB3: 4, 5, 6, 7, 8, 10mm

52320 22,00€

0.76	5	20	480
Kg	Sub	ff	



1/2" 100mm: M12, M13, M14
3/8" 90mm: M6, M7, M8, M10

7 PCS

CrV



PRESENTED IN METALLIC GUIDE

BIT SOCKET XZN SP. VAG

12029 5,50€

0.17	5	100	1500
Kg	Sub	ff	



TAMPER PROOF M16X58MM



12030 6,50€

0.25	8	80	-
Kg	Sub	ff	

TAMPER PROOF M16X100MM



CrV 1/2"

EXTRA-LONG 12-POINT BIT SOCKET 800mm 1/2"

REF.	DESCRIPTION	Kg	Sub	ff	€	
52059	Ø 8mm - 800mm	0,58	-	25	1.750	29,00€
52060	Ø 10mm - 800mm	0,58	-	25	1.750	32,00€
53667	Ø 12mm - 800mm	0,80	10	20	-	32,00€
53668	Ø 14mm - 800mm	1,05	10	20	-	34,00€

800mm



CrV 1/2"



INSULATED TOOLS

20 PIECES TOOL SET

54091 441,00€

4,20	-	3	72

IT CONTAINS

	3/8" x10 45mm	8, 10, 11, 12, 13, 14, 16, 17, 18, 19, 21, 22mm
	3/8" x1	200mm
	1/2" x1	125mm
	3/8" x1	200mm

	x2	4x100mm, 5,5x125mm
	x2	PH1x80mm PH2x100mm
	x1	185mm
	x1	
	x1	185mm
	x6	7x86mm, 8x99mm, 10x109mm, 12x127mm, 14x141mm, 17x156



EVA INSULATED TOOL MODULE VDE

54093 441,00€

3,25	-	4	80

IT CONTAINS

	3/8" x10 45mm	8, 10, 11, 12, 13, 14, 16, 17, 18, 19, 21, 22mm
	3/8" x1	200mm
	1/2" x1	125mm
	3/8" x1	200mm

	x2	4x100mmL, 5,5x125mmL
	x2	PH1x80mm PH2x100mm
	x1	185mm
	x1	
	x1	185mm
	x6	7x86mm, 8x99mm, 10x109mm, 12x127mm, 14x141mm, 17x156



20 PIECES TOOL SET

53154 462,00€

3,30	-	3	72

IT CONTAINS

	3/8" x12	8, 10, 11, 12, 13, 14, 16, 17, 18, 19, 21, 22mm
	1/2" x1	200mm
	1/2" x2	125, 250mm
	3/8" x1	200mm
	3/8" x4 75mm	4, 5, 6, 8mm

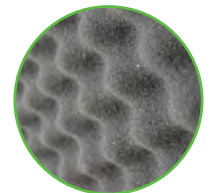

INSULATED SCREWDRIVER UP TO 1000V

52009 36,00€

0,34	10	50	1200
Kg	Sub	Box	Tray

CrV
6 PCS



IT CONTAINS

	x2	PH1x100, PH2x100
	x4	SL0.4x2.5x100, SL0.8x4.0x100, SL1.0x5.5x100, SL1.2x6.5x100mm



With: DIN EN60900:2005-01 - EN60900:2004

50 PIECES INSULATED SCREWDRIVER SET

52521 125,00€

1,43	-	6	216
Kg	Sub	Box	Tray

CrV
50 PCS



IT CONTAINS

	x3	PH0, PH1, PH2		x1	89
	x7	SL0.4x2.0, SL0.4x2.5, SL0.5x3.0, SL0.6x3.5, SL0.8x4.0, SL1.0x5.5, SL1.2x6.5mm		x1	89
	x3	PZ0, PZ1, PZ2		Voltage Tester: 3.0 x 70 + Torx 31 x 105	
	x9	T6, T8, T9, T10, T15, T20, T25, T27, T30		x5	H2.5, H3, H4, H5, H6
	x2	R1, R2		x3	M4x4.0, M5x5.0, M6x5.0
	x4	1, 2, 3, 4		x4	4, 6, 8, 10mm
	x4	4, 6, 8, 10		x2	R1, R2
				x2	6.3 x 89, 8.1 x 89



7 PIECES INSULATED SCREWDRIVER SET UP TO 1000V

52519 25,50€

0,14	5	10	840
Kg	Sub	Box	Tray

CrV
7 PCS

IT CONTAINS

	x2	PH00x50, PH0x50mm
	x5	SL1.5x0.23x50, SL1.8x0.30x50, SL2.0x0.40x50, SL2.5x0.40x50, SL3.0x0.50x50mm

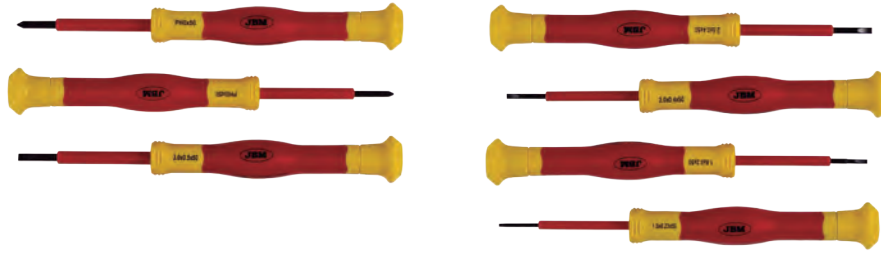

8 PIECES INSULATED SCREWDRIVER SET EVA TRAY - CARBON FINISH

15162 30,20€

0,65	-	10	240
Kg	Sub	Box	Tray

	x4	0.5x3.0x75, 0.8x4.0x100, 1.0x5.5x125, 1.2x6.5x150mm
	x3	PH0x75, PH1x80, PH2x100mm

8 PCS

SPARE PARTS AVAILABLE

REF.	Ø	Kg	Sub	Box	Tray	€
15227	0.5x3.0x75mm	0,02	10	50		3,50€
15228	0.8x4.0x100mm	0,05	10	50		4,00€
15229	1.0x5.5x125mm	0,08	5	50		5,00€
15230	1.2x6.5x150mm	0,11	5	50		5,00€
15231	PH0x75mm	0,02	10	50		3,50€
15232	PH1x80mm	0,05	10	50		4,00€
15233	PH2x100mm	0,08	5	50		5,00€
15234	Voltage tester 140mm	0,02	10	50		3,00€

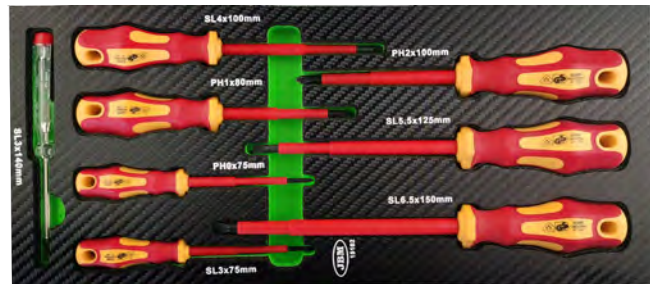

INSULATED KNIFE

STRAIGHT

53164 16,50€

0,10	6	36	1152
Kg	Sub	Box	Tray



HOOK

53165 19,60€

0,10	6	36	1152
Kg	Sub	Box	Tray



180mm
50mm
CrV





HAND TOOLS

- 34 SPANNERS
- 41 SAE TOOLS
- 42 SCREWDRIVERS
- 44 MEASURING TOOLS
- 45 PADLOCKS
- 46 HAMMERS
- 47 HACKSAWS
- 48 CHISELS
- 49 RIVETERS
- 50 RATCHETS
- 54 EXTENSION BARS
- 55 INSPECTION TOOLS
- 57 TUBE CUTTERS
- 57 WIRE CUTTERS
- 57 PLIERS
- 63 PIPE WRENCHES
- 64 BAR CLAMPS

6 PIECES RATCHETING COMBINATION SPANNER SET

54101

61,00€

8x9, 10x11, 12x13, 14x15, 16x18, 17x19mm



6 PCS

0,90	-	10	750
Kg	Sub	Box	Tray



SPARE PARTS AVAILABLE

REF.	mm	Kg	Sub	Box	Tray	€
15632	8x9	0,15	10	9,35€		
15633	10x11	0,16	10	9,50€		
15634	12x13	0,19	10	10,60€		
15635	14x15	0,22	10	11,00€		
15636	16x18	0,26	5	12,30€		
15637	17x19	0,28	10	12,50€		



54117

74,00€

8,9,10,11,12,13,14,15,16,17,18,19mm



12 PCS

1,80	5	10	240
Kg	Sub	Box	Tray



SPARE PARTS AVAILABLE

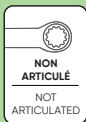

51318

98,00€

8, 9, 10, 11, 12, 13, 14, 15, 16, 17, 18, 19mm



12 PCS

2,15	5	10	240
Kg	Sub	Box	Tray



CHROME FINISH



SPARE PARTS AVAILABLE



REF.	mm	Kg	Sub	Box	Tray	€
10552	8mm	0,06	10	7,10€		
10553	9mm	0,07	10	7,35€		
10554	10mm	0,09	10	7,50€		

REF.	mm	Kg	Sub	Box	Tray	€
10555	11mm	0,09	10	7,80€		
10556	12mm	0,11	10	8,10€		
10557	13mm	0,13	10	8,10€		

53017

57,00€

8, 10, 11, 13, 14, 17, 19mm



7 PCS

1,30	5	10	330
Kg	Sub	Box	Tray



CHROME FINISH



REF.	mm	Kg	Sub	Box	Tray	€
10558	14mm	0,15	10	9,35€		
10559	15mm	0,16	10	9,50€		
10560	16mm	0,19	10	10,60€		

REF.	mm	Kg	Sub	Box	Tray	€
10561	17mm	0,22	10	11,00€		
10562	18mm	0,26	5	12,30€		
10563	19mm	0,28	10	12,50€		

7 PIECES EXTRA-LONG RATCHET WRENCH SET

54066

83,00€

2,00	5	175
Kg	Sub	Box

CARBON FIBER FIBER MODULE

CHROME FINISH



7 PCS



SPARE PARTS AVAILABLE



REF.	mm	Kg	Sub	Box	Tray	€
13453	8mm	0,1	6	9,00€		
13454	10mm	0,15	6	9,50€		
13455	12mm	0,21	6	10,50€		
13456	13mm	0,20	6	11,50€		
13457	14mm	0,25	6	12,00€		
13460	17mm	0,4	6	15,00€		
13462	19mm	0,5	6	17,00€		

8mm (23,5mmL)
10mm (29,3mmL)
12mm (32,8mmL)
13mm (34,9mmL)
14mm (36,7mmL)
17mm (41mmL)
19mm (42mmL)

22 PIECES COMBINATION RATCHET WRENCH CASE

54041 198,00€

900	-	2	42
Kg	SUB	11	11



6, 7, 8, 9, 10, 11, 12, 13, 14, 15, 16, 17, 18, 19, 20, 21, 22, 23, 24, 27, 30, 32mm



22
PCS

SPARE PARTS AVAILABLE



REF.54041, 54117, 15122, 53871
SPARE PARTS AVAILABLE

12 PCS COMBINATION RATCHET WRENCH SET IN CARBON FIBER FINISH EVA

REF.	mm	Kg	Sub	€	REF.	mm	Kg	Sub	€
13463	6mm	0,03	10	5,30€	13474	17mm	0,19	10	8,70€
13464	7mm	0,04	10	5,30€	13475	18mm	0,22	10	9,10€
13465	8mm	0,05	10	5,55€	13476	19mm	0,22	10	9,60€
13466	9mm	0,06	10	5,55€	13477	20mm	0,23	6	9,85€
13467	10mm	0,1	10	6,00€	13478	21mm	0,37	6	12,20€
13468	11mm	0,08	10	6,25€	13479	22mm	0,37	6	13,10€
13469	12mm	0,09	10	6,25€	13480	23mm	0,37	6	15,50€
13470	13mm	0,1	10	6,60€	13481	24mm	0,53	6	15,80€
13471	14mm	0,11	10	6,90€	13482	27mm	0,6	6	22,10€
13472	15mm	0,13	10	7,25€	13483	30mm	0,8	6	25,50€
13473	16mm	0,15	10	8,10€	13484	32mm	1,12	6	27,20€

15122 74,00€

1,70	-	10	200
Kg	SUB	11	11

8, 9, 10, 11, 12, 13, 14, 15, 16, 17, 18, 19mm



12
PCS

CHROME FINISH

SPARE PARTS AVAILABLE



12 PIECES RATCHETING COMBINATION SPANNER SET

53871 60,00€

1,60	2	6	288
Kg	SUB	11	11

SPARE PARTS AVAILABLE



8, 9, 10, 11, 12, 13, 14, 15, 16, 17, 18, 19mm



12
PCS

CHROME FINISH



12 PIECES STUBBY FLEXIBLE RATCHET RING SPANNER SET

54032 84,00€

1,45	-	10	240
Kg	SUB	11	11



8, 9, 10, 11, 12, 13, 14, 15, 16, 17, 18, 19mm



12
PCS

REF.	mm	Kg	Sub	€	REF.	mm	Kg	Sub	€
15328	8mm	0,05	12	6,00€	15334	14mm	0,11	12	7,00€
15329	9mm	0,17	12	5,50€	15335	15mm	0,17	12	7,50€
15330	10mm	0,22	12	5,50€	15336	16mm	0,22	12	8,00€
15331	11mm	0,31	12	5,50€	15337	17mm	0,31	12	8,50€
15332	12mm	0,45	12	6,00€	15338	18mm	0,45	12	9,00€
15333	13mm	0,47	12	6,50€	15339	19mm	0,47	12	9,50€

8 PIECES STUBBY RATCHETING RATCHET WRENCH

54110 46,00€

0,90	-	10	840
Kg	SUB	11	11



10, 11, 12, 13, 14, 15, 17, 19mm



8
PCS

SPARE PARTS AVAILABLE

REF.	mm	Kg	Sub	€
13491	10mm	0,5	10	5,30€
13492	11mm	0,6	10	5,35€
13493	12mm	0,7	10	5,50€
13494	13mm	0,8	10	6,00€
13495	14mm	0,9	10	6,40€
13496	15mm	0,12	10	6,60€
13497	17mm	0,14	10	7,50€
13498	19mm	0,19	10	8,50€

6 PIECES FLEXIBLE RATCHET WRENCH SET

53018 119,00€

2,66 - 5 125



CHROME FINISH



8x9,10x11, 12x13,
14x15, 16x18,
17x19mm



6
PCS

SPARE PARTS AVAILABLE

REF.	mm	Kg	Sub	€
13447	8x9mm	0,1	6	16,50€
13448	10x11mm	0,15	6	17,50€
13449	12x13mm	0,25	6	20,00€
13450	14x15mm	0,3	6	23,00€
13451	16x18mm	0,35	6	28,00€
13452	17x19mm	0,4	6	29,50€

SET OF 4 TORX DOUBLE END RATCHET RING WRENCH SET

50754 98,00€

0,82 - 20 360



CHROME FINISH

- 0° to 180° hinged head.
- 72-tooth ratchet spanner with 5° arch.



E6 x E8
E10 x E12
E14 x E18
E20 x E24



4
PCS

SPARE PARTS AVAILABLE

REF.	mm	Kg	Sub	€
10527	E6x E8	0,1	10	13,10€
10528	E10x E12	0,15	10	15,80€
10529	E14x E18	0,25	10	18,00€
10530	E20x E24	0,35	10	28,70€

DOUBLE END RATCHET RING WRENCH SET « 4 IN 1 »

15316 58,00€

0,85 - 10 260



CHROME FINISH



8-9-10-11-12-13-
14-15-16-17-18-
19mm



3
PCS

SPARE PARTS AVAILABLE

REF.	mm	Kg	€
15515	12-13mm x 8-10mm	0,13	15,50€
15516	14-15mm x 9-11mm	0,18	19,00€
15517	18-19mm x 16-17mm	0,37	22,50€

CASE WITH 6 HINGED SOCKET WRENCH SET 12-POINT

51659 59,00€

1,60 - 10 240



CHROME FINISH



8x9, 10x11, 12x13,
14x15, 16x17,
18x19mm



6
PCS

SPARE PARTS AVAILABLE

REF.	Ø	Kg	Sub	€
10621	XZN 8-9	0,09	-	9,50€
10622	XZN 10-11	0,13	-	10,00€
10623	XZN 12-13	0,16	5	12,60€
10624	XZN 14-15	0,20	-	13,50€
10625	XZN 16-17	0,29	-	15,70€
10626	XZN 18-19	0,37	-	17,80€

SET OF 4 TORX HINGED SOCKET WRENCH SET

50622 64,00€

1,05 - 10 320



CHROME FINISH



E6x E8, E10x E12,
E14x E18, E20x E24



4
PCS

SPARE PARTS AVAILABLE

REF.	Ø	Kg	€
10617	E6x E8	0,07	14,10€
10618	E10x E12	0,11	15,10€
10619	E14x E18	0,20	15,70€
10620	E20x E24	0,34	16,20€

21 PIECES DOUBLE OPEN END

54079 83,00€

4,00 - 8 160
Kg SUB ff

21 PCS

6mm, 7mm, 8mm, 9mm, 10mm, 11mm, 12mm, 13mm, 14mm, 15mm, 16mm, 17mm, 18mm, 19mm, 20mm, 21mm, 22mm, 24mm, 27mm, 30mm, 32mm

JBM 21 PCS CrV REF. 54079

SET OF COMBINATION SPANNERS

14 SPANNERS

50560 38,60€

1,25 5 20 240
Kg SUB ff

ZINC FINISH

CrV 6, 7, 8, 9, 10, 11, 12, 13, 14, 15, 16, 17, 18, 19mm

54097 38,90€

1,40 - 10 570
Kg SUB ff

CrV 14 PCS 6, 7, 8, 9, 10, 11, 12, 13, 14, 15, 16, 17, 18, 19mm

SPARE PARTS AVAILABLE

ZINC FINISH	mm	Kg	Sub	ff	€
10548	6mm	0,03	10	100	1,75€
10549	7mm	0,03	10	100	2,00€
10550	8mm	0,04	10	100	2,15€
10551	9mm	0,04	10	100	2,15€
10531	10mm	0,05	10	100	3,00€

ZINC FINISH	mm	Kg	Sub	ff	€
10532	11mm	0,05	10	100	2,70€
10533	12mm	0,07	10	100	3,00€
10534	13mm	0,08	10	100	3,25€
10535	14mm	0,06	10	100	3,50€
10536	15mm	0,10	10	100	3,65€

ZINC FINISH	mm	Kg	Sub	ff	€
10537	16mm	0,11	10	100	3,90€
10538	17mm	0,14	10	100	4,30€
10539	18mm	0,16	10	100	4,75€
10540	19mm	0,20	10	60	5,25€

7 PIECES COMBINATION SPANNER SET

54120 59,00€

2,89 - 6 252
Kg SUB ff

CrV 20, 21, 22, 24, 27, 30, 32mm

7 PCS

SPARE PARTS AVAILABLE

ZINC FINISH	mm	Kg	ff	€
10541	20mm	0,21	60	5,55€
10542	21mm	0,25	50	5,85€
10543	22mm	0,25	50	7,00€
10544	24mm	0,33	50	8,10€
10545	27mm	0,41	50	9,75€
10546	30mm	0,52	25	11,60€
10547	32mm	0,59	25	13,50€

54174 139,00€

8,70 - 2 750
Kg SUB ff

XL CrV 34,36,38, 41,46,50mm

6 PCS

SPARE PARTS AVAILABLE

ZINC FINISH	mm	Kg	ff	€
16020	34mm	0,21	-	17,00€
16021	36mm	0,25	-	19,50€
16022	38mm	0,41	-	23,00€
16023	41mm	-	-	26,50€
16024	46mm	-	-	34,50€
16025	50mm	-	-	37,50€

10 PCS CROWFOOT WRENCH SET 3/8"

54187 39,30€

0,55 5 20 1800
Kg SUB ff

CrV 10, 11, 13, 14, 15, 16, 17, 18, 19, 22mm

3/8"

8 PIECES SHORT COMBINATION SPANNER SET

50564 30,00€

0.60	5	20	600
Kg	sub	ft	

CHROME FINISH

SPARE PARTS AVAILABLE

REF.	mm	Kg	sub	ft	€
10564	10	0,05	10	100	2,50€
10565	11	0,05	10	100	3,50€
10566	12	0,05	10	100	3,50€
10567	13	0,05	10	100	3,50€
10568	14	0,05	10	100	4,00€
10569	15	0,05	10	100	4,50€
10570	17	0,10	10	100	4,50€
10571	19	0,15	10	100	5,00€



8 PCS

10, 11, 12, 13, 14, 15, 17, 19mm



DOUBLE OPEN END SPANNER SET

12 SPANNERS

6x7, 8x9, 10x11, 12x13, 14x15, 16x17, 18x19, 20x22, 21x23, 24x27, 25x28, 30x32mm



12 PCS

ZINC FINISH

51529 59,00€

2.63	-	5	200
Kg	sub	ft	

CHROME FINISH

52973 59,00€

2.50	-	5	160
Kg	sub	ft	

SPARE PARTS AVAILABLE

REF.	mm	Kg	sub	ft	€
10589	6x7	0,03	10	100	2,00€
10590	8x9	0,04	10	100	2,40€
10579	10x11	0,06	10	100	3,00€
10580	12x13	0,07	10	100	3,10€
10581	14x15	0,10	10	100	3,40€
10582	16x17	0,14	10	100	4,00€
10583	18x19	0,19	10	100	4,15€
10584	20x22	0,25	60	100	5,05€
10585	21x23	0,31	-	50	6,75€
10586	24x27	0,35	-	50	7,60€
10587	25x28	0,36	-	50	9,80€
10588	30x32	0,54	-	25	10,50€



12 SPANNERS

54149 60,00€

2.75	-	6	240
Kg	sub	ft	

6x7, 8x9, 10x11, 12x13, 14x15, 16x17, 18x19, 20x22, 21x23, 24x27, 25x28, 30x32mm

12 PCS



ZINC FINISH

50561 19,20€

0.69	5	20	400
Kg	sub	ft	

SPARE PARTS AVAILABLE

REF.	mm	Kg	sub	ft	€
10589	6x7	0,03	10	100	2,00€
10590	8x9	0,04	10	100	2,40€
10579	10x11	0,06	10	100	3,00€
10580	12x13	0,07	10	100	3,10€
10581	14x15	0,10	10	100	3,40€
10582	16x17	0,14	10	100	4,00€
10583	18x19	0,19	10	100	4,15€



7 SPANNERS

6x7, 8x9, 10x11, 12x13, 14x15, 16x17, 18x19mm



7 PCS

7 SPANNERS

54150 23,50€

0.75	10	20	720
Kg	sub	ft	

6x7, 8x9, 10x11, 12x13, 14x15, 16x17, 18x19mm

7 PCS



SPARE PARTS AVAILABLE

ZINC FINISH	mm	Kg	sub	ft	€
10589	6x7	0,03	10	100	2,00€
10590	8x9	0,03	10	100	2,40€
10579	10x11	0,06	5	100	3,00€

ZINC FINISH	mm	Kg	sub	ft	€
10580	12x13	0,07	10	100	3,10€
10581	14x15	0,10	10	100	3,40€
10582	16x17	0,14	10	100	4,00€

ZINC FINISH	mm	Kg	sub	ft	€
10583	18x19	0,19	10	100	4,15€
10584	20x22	0,25	-	100	5,05€
10585	21x23	0,31	-	50	6,75€

ZINC FINISH	mm	Kg	sub	ft	€
10586	24x27	0,35	-	50	7,60€
10587	25x28	0,36	-	50	9,80€
10588	30x32	0,54	-	25	10,50€

8 PIECES 12-POINT STARTER & BLOCK WRENCH SPANNER SET

52451 42,00€

0,93	5	20	480
Kg	Sub	Pf	Pf

CHROME FINISH

SPARE PARTS AVAILABLE



54159 47,00€

1,05	-	10	460
Kg	Sub	Pf	Pf

6x7, 8x9, 10x11, 12x13, 14x15, 16x17, 18x19, 20x22mm



4 PIECES FLAT TORX SPANNER SET

54115 26,80€

0,35	-	10	50
Kg	Sub	Pf	Pf

E6xE8, E10xE12, E14xE18, E20xE24

4 PCS

CHROME FINISH



5 PIECES OPEN RING END SPANNER SET

54081 28,00€

0,75	-	10	750
Kg	Sub	Pf	Pf

10 x 11 HEX, 12 x 13 HEX, 14 x 15 HEX, 16 x 17 HEX, 18 x 19 HEX

5 PCS



DOUBLE OFFSET RING SPANNER

12 SPANNERS

CHROME FINISH

54119 78,00€

3,20	-	6	168
Kg	Sub	Pf	Pf

6x7, 8x9, 10x11, 12x13, 14x15, 16x17, 18x19, 20x22, 21x23, 24x27, 25x28, 30x32mm



12 PCS



7 SPANNERS

ZINC FINISH

50562 23,50€

0,87	5	20	560
Kg	Sub	Pf	Pf

6x7, 8x9, 10x11, 12x13, 14x15, 16x17, 18x19mm



7 PCS



50562



SPARE PARTS AVAILABLE

ZINC FINISH	mm	Kg	Sub	Pf	€
10627	6x7	0,04	10	100	2,80€
10628	8x9	0,06	10	100	3,10€
10629	10x11	0,08	10	100	3,65€

ZINC FINISH	mm	Kg	Sub	Pf	€
10630	12x13	0,11	10	100	3,90€
10631	14x15	0,14	10	100	4,20€
10632	16x17	0,18	10	100	5,30€

ZINC FINISH	mm	Kg	Sub	Pf	€
10633	18x19	0,22	10	100	6,60€
10634	20x22	0,43	-	50	7,80€
10635	21x23	0,30	-	50	8,15€

ZINC FINISH	mm	Kg	Sub	Pf	€
10636	24x27	0,35	-	25	8,80€
10637	25x28	0,48	6	24	12,10€
10638	30x32	0,73	6	25	12,70€

4 PIECES DOUBLE RING SPANNER SET IN CARBON FIBER FINISH EVA TRAY

15156 70,00€

2,05	-	10	180
Kg	Sub	Pf	Pf

CHROME FINISH

SPARE PARTS AVAILABLE



REF.	mm	Kg	Sub	Pf	€
15206	21x23	0,45	5	50	15,00€
15207	24x27	0,5	5	50	16,50€
15208	25x28	0,45	5	50	17,00€
15209	30x32	0,67	10	50	18,00€



4 PCS

21x23, 24x27, 25x28, 30x32mm



VAT not included

6 PIECES 12-POINT EXTRA LONG SPANNER SETS

51864 64,00€

1.87	-	10	210
Kg	SUB	ff	

10x11mm (290mmL),
12x14mm (330mmL),
13x15mm (368mmL),
16x18mm (407mmL),
17x19mm (407mmL),
22x24mm (430mmL)

SPARE PARTS AVAILABLE

REF.	Ø	Kg	ff	€
11244	XL XZN 10x11 0,13	5		8,50€
11245	XL XZN 12x14 0,18	-		9,15€
11246	XL XZN 13x15 0,25	6		12,40€
11247	XL XZN 16x18 0,30	6		14,00€
11248	XL XZN 17x19 0,31	6		14,60€
11249	XL XZN 22x24 0,43	6		26,50€



6 PCS

52912 91,00€

1.62	-	10	210
Kg	SUB	ff	

E6xE7 (200mmL),
E8xE10 (235mmL),
E11xE12 (290mmL),
E14xE16 (370mmL),
E18xE20 (410mmL),
E22xE24 (420mmL)

CHROME FINISH

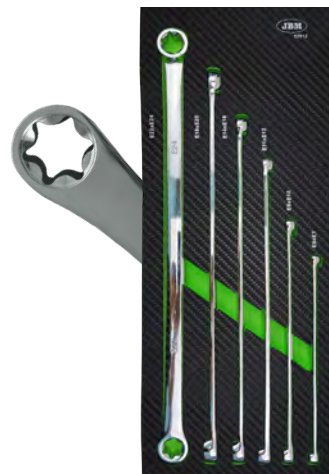

6 PCS

14 PIECES ANGLED OPEN SOCKET WRENCH SET

51528 49,00€

3.55	-	5	270
Kg	SUB	ff	

ZINC FINISH

REFmm	Kg	€
10603	8 0,07	2,10€
10604	9 0,08	2,25€
10591	10 0,09	2,50€
10592	11 0,12	2,55€
10593	12 0,16	3,15€
10594	13 0,17	3,20€
10595	14 0,20	3,35€
10596	15 0,25	4,25€
10597	16 0,30	4,50€

SPARE PARTS AVAILABLE

REF.	mm	Kg	€
10598	17	0,32	4,60€
10599	18	0,43	6,00€
10600	19	0,41	6,25€
10601	20	0,45	6,50€
10602	21	0,47	7,05€



8, 9, 10, 11, 12, 13, 14, 15,
16, 17, 18, 19, 20, 21mm



14 PCS



8 PCS TUBULAR WRENCH SET

53420 72,00€

1.50	-	20	540
Kg	SUB	ff	

ZINC FINISH

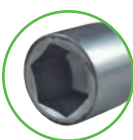

6x7, 8x9, 10x11, 12x13, 14x15,
16x17, 18x19, 20x22mm



8 PCS

8 PIECES T-HANDLE KEY SET

53979 34,60€

1.00	-	10	180
Kg	SUB	ff	

T10X75,
T15X75,
T20X100,
T25X100,
T30X150,
T40X150,
T45X200,
T50X200mm



8 PIECES BALL END T-HANDLE KEY SET

53980 34,60€

1.00	-	10	180
Kg	SUB	ff	

H2x100,
H2.5x100,
H3x100,
H4x150,
H5x150,
H6x200,
H8x200,
H10x200



9 PCS SET



EXTRA LONG

53737 12,50€

0,42	10	40	1000
Kg	SUB	ff	ff



90-218mm

LONG

53739 10,50€

0,32	10	40	1440
Kg	SUB	ff	ff



86-150mm

SHORT

53955 10,00€

0,25	10	40	1480
Kg	SUB	ff	ff



72-170mm

T10, T15, T20, T25, T27, T30, T40, T45, T50

53737/53739/53955

EXTRA LONG

53738 10,90€

0,45	10	40	1000
Kg	SUB	ff	ff



90-220mm

9 PCS



LONG

53740 9,10€

0,37	10	40	1200
Kg	SUB	ff	ff



72-170mm

SHORT

53954 8,50€

0,25	10	40	1480
Kg	SUB	ff	ff



43-97mm



1,5, 2, 2,5, 3, 4, 5, 6, 8, 10mm

53738/53740/53954

SAE TOOLS

17 PIECES COMBINATION SPANNER SET SAE

51890 92,00€

ZINC FINISH

17 PCS

4,45	-	4	168
Kg	SUB	ff	ff



9 PIECES HEXAGONAL KEY SET SAE

54005 14,00€

72-170mm

9 PCS

CrV

0,35	10	40	1200
Kg	SUB	ff	ff

1/16", 5/64", 3/32", 1/8", 5/32", 3/16", 1/4", 5/16", 3/8"

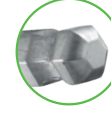

37 PIECES SOCKET SET SAE

54106 89,00€

4,70	-	3	108
Kg	SUB	ff	ff



CrV

1/2"

1/4"

37 PCS

CONTAINS

	1/2"	x17	5/16", 3/8", 7/16", 1/2", 9/16", 19/32", 5/8", 11/16", 3/4", 13/16", 7/8", 15/16", 1", 1-1/16", 1-1/8", 1-3/16", 1-1/4"
	1/4"	x8	3/16", 7/32", 1/4", 9/32", 5/16", 11/32", 3/8", 7/16"
	53076	x2	1/2" - 1/4"
	1/2"	x2	5", 10"
	1/4"	x1	3"
		x1	1/2"



	x1	1/4"
	x2	1/2" - 1/4"
	x1	1/4"

208 PCS BIT SET IN CASE

53574 47,00€

2,29	-	6	216
Kg	Sub	Box	Case



208
PCS
CrV

CONTAIN

25mmL	x12	1,5, 2, 2,5, 3, 3,5, 4, 4,5, 5, 5,5, 6, 7, 8mm	25mmL	x4	4, 6, 8, 10mm
	x10	1/16, 5/64, 3/32, 7/64, 1/8, 9/64, 5/32, 3/16, 7/32, 1/4	50mmL	x4	4, 6, 8, 10mm
50mmL	x5	2,5, 3, 4, 5, 6mm	25mmL	x4	1, 2, 3, 4mm
75mmL	x5	2,5, 3, 4, 5, 6mm	50mmL	x4	1, 2, 3, 4mm
25mmL	x18	PH00, PH0, PH1(x5), PH2(x5), PH3(x5), PH4	25mmL	x6	2, 2,5, 3, 4, 5, 6mm
50mmL	x3	PH1, PH2, PH3	25mmL	x6	5/64, 3/32, 7/64, 1/8, 9/64, 5/32
75mmL	x3	PH1, PH2, PH3	25mmL	x13	T5, 6, 7, 8, 9, 10, 15, 20, 25, 27, 30, 40, 45
25mmL	x17	PZ00, PZ0, PZ1(x5), PZ2(x5), PZ3(x4), PZ4	25mmL	x3	1, 2, 3mm
50mmL	x3	PZ1, PZ2, PZ3	25mmL	x4	0, 1, 2, 3mm
75mmL	x3	PZ1, PZ2, PZ3	25mmL	x3	M5, M6, M8
25mmL	x14	T5, T6, T7, T8, T9, T10, T15, T20, T25, T27, T30, T35, T40, T45	25mmL	x9	TS10, TS15, TS20, TS25, TS27, TS30, TS40, TS45, TS50
50mmL	x7	T10, T15, T20, T25, T27, T30, T40	25mmL	x12	SL4,5, SL5, SL5.5, SL6, SL6.5, SL7, SL8
75mmL	x7	T10, T15, T20, T25, T27, T30, T40			
25mmL	x3	6, 8, 10mm			
50mmL	x3	6, 8, 10mm			

mm	x10	4, 5, 6, 7, 8, 9, 10, 11, 12, 13
"	x10	5/32, 3/16, 7/32, 1/4, 9/32, 5/16, 1/2
mm	x1	1/4"
	x1	Convert

8 PIECES PRECISION SCREWDRIVER SET SHORT SHAFT

52500 19,00€

0,33	-	60	720
Kg	Sub	Box	Case

8
PCS

SHORT

PH00x25	SL0.4x2x25
PH0x25	SL0.4x2.5x25
PH1x25	SL0.5x3x25
	SL0.5x3.5x25
	SL0.8x4x25



53917 9,00€

0,20	5	50	950
Kg	Sub	Box	Case

7
PCS

LARGE

PH00, PH0, PH1	SL1.4, SL2.0, SL2.4, SL3.0
----------------	----------------------------



SCREWDRIVER SET WITH INTERCHANGEABLE HANDLE

53010 18,00€

0,72	5	20	480
Kg	Sub	Box	Case

CONTAIN

x2	PH1, PH2
x2	4x6, 5x7mm
x3	T10x15, T20x25, T30x40
x3	H4x4mm, round end H5x5mm, round end H6x6mm, round end



ERGONOMIC HANDLE

SET OF 4 FLAT SCREWDRIVERS HAMMER HEAD

50902 13,00€

0,70	6	42	648
Kg	Sub	Box	Case

3", 4", 6", 8"

4
PCS



REVERSIBLE DOUBLE END SCREWDRIVER

54060 6,00€

0,15	10	60	1500
Kg	Sub	Box	Case

SL6x150mm
PH2x150mm



54061 6,00€

0,10	10	60	1800
Kg	Sub	Box	Case

SL6x100mm
PH2x100mm



IMPACT SCREWDRIVER 8 PIECES 1/2"

53694 18,40€

1,00	6	24	936
Kg	Sub	Box	Case

CrV **1/2"** **8**
PCS

CONTAINS

1/2"	x1	PH 2x36mm, 3x36mm, 3x70mm
1/2"	x1	SL 7x36mm, 8x36mm, 8x70mm



6 PIECES GO-THROUGH SCREWDRIVER SET

54071 26,50€

1.10 - 10 270
Kg SUB 11 11



SL8x150mm
SL6.5x100mm
SL5.5x75mm
PH3x150mm
PH2x100mm
PH1x75mm

X3 X3

6 PIECES SCREWDRIVER SET

54070 18,00€

0.50 - 10 360
Kg SUB 11 11

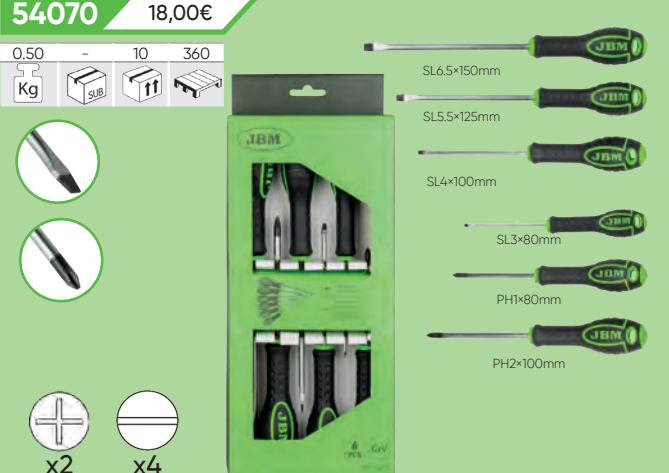

SL6.5x150mm
SL5.5x125mm
SL4x100mm
SL3x80mm
PH1x80mm
PH2x100mm

x2 x4

HAMMER CAP SCREWDRIVER SET

54126 39,00€

2.75 - 4 108
Kg SUB 11 11



12 PCS

x6
PH0x75mm
PH1x75mm
PH2x38mm
PH2x100mm
PH3x125mm
PH4x150mm

x6
SL3.2x75mm
SL5x75mm
SL6x38mm
SL6x100mm
SL8x150mm
SL9.5x200mm

SCREWDRIVER EVA TRAY - CARBON FINISH

53943 21,50€

0.80 - 10 240
Kg SUB 11 11

180mm 380mm 30mm

x7 PH4x200, PH3x150, PH2x100, PH2x38, PH1x80, PH0x120, PH1x100

53944 19,50€

0.80 - 10 240
Kg SUB 11 11

x7 SL9x200, SL4x125, SL5x100, SL5x80, SL6x38, SL6x100, SL8x150mm

53945 18,90€

0.60 - 10 240
Kg SUB 11 11

x7 T8x75, T9x75, T10x75, T15x75, T20x75, T25x100, T27x100



FLEXIBLE SCREWDRIVER

52170 16,00€

0.27 12 48 672
Kg SUB 11 11

1/4" 7 PCS

4, 5, 6, 7, 8, 10mm



3 PIECES FLEXIBLE SCREWDRIVER SET

52169 25,00€

0.45 12 48 672
Kg SUB 11 11

3 PCS

6, 7, 8mm



LONG FLEXIBLE SCREWDRIVER

53575 16,00€

0.40 10 40 480
Kg SUB 11 11

CrV 1/4" 4 PCS

500mm

4, 5, 7mm

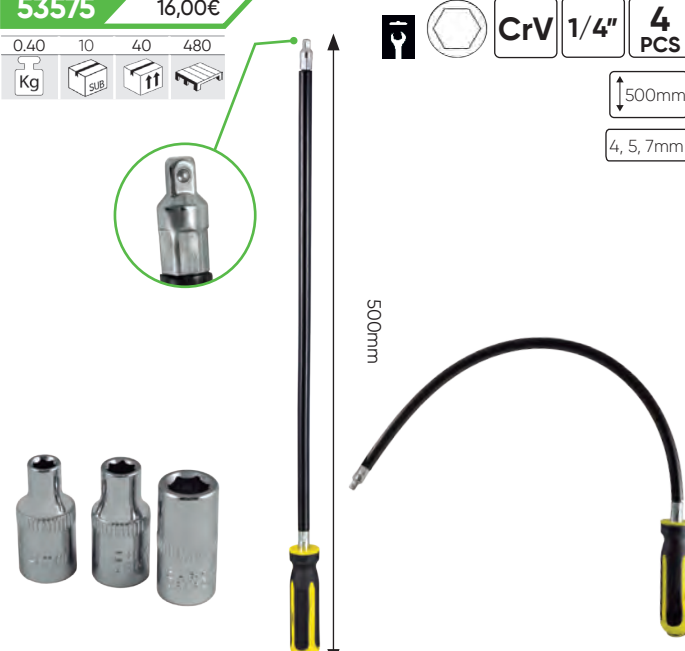

VAT not included

JBM / www.jbmcamp.com

ALUMINIUM

53613 19,50€

0.55	5	30	1260
Kg	SUB	↑↑	↑↑

500mm

53614 21,50€

0.60	5	30	840
Kg	SUB	↑↑	↑↑

600mm

53615 34,60€

0.85	5	20	600
Kg	SUB	↑↑	↑↑

800mm



MAGNETIC TUBULAR

53616 10,40€

0.30	5	60	1260
Kg	SUB	↑↑	↑↑

500mm

53617 9,25€

0.30	5	60	840
Kg	SUB	↑↑	↑↑

600mm

53618 13,90€

0.35	5	30	600
Kg	SUB	↑↑	↑↑

800mm

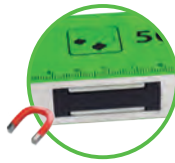
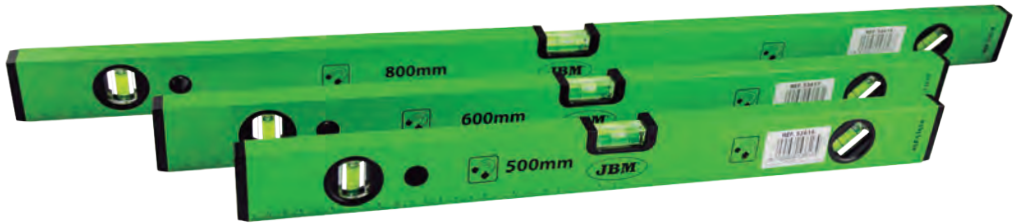

LEVEL DISPLAY

14183 31,00€

0.80	10
Kg	↑↑



MEASURING TAPE

53027 9,00€

0.40	12	48	1500
Kg	SUB	↑↑	↑↑

7,5M x25mm

53026 5,80€

0.26	12	48	2016
Kg	SUB	↑↑	↑↑

5M x25mm

53025 3,50€

0.13	12	48	2016
Kg	SUB	↑↑	↑↑

3M x16mm



PROFESSIONAL CUTTER

51909 2,46€

0.07	24	192	2304
Kg	SUB	↑↑	↑↑

10cm

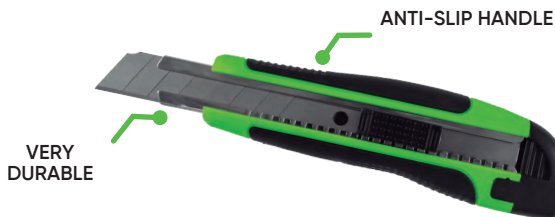

IN 24 UNITS
DISPLAY CASE

PADLOCK

53405 5,30€

0.10 8 96 3168
Kg SUB 11 12 32mm



LARGE

53403 6,50€

0.15 8 96 3168
Kg SUB 11 12 38mm



x3

53404 6,50€

0.15 8 96 3168
Kg SUB 11 12 38mm



53406 8,55€

0.30 8 48 3168
Kg SUB 11 12 50mm



53409 9,00€

0.30 8 48 3168
Kg SUB 11 12 50mm



53407 12,70€

0.35 8 48 3168
Kg SUB 11 12 63mm

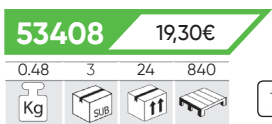

53408 19,30€

0.48 3 24 840
Kg SUB 11 12 75mm

WATER RESISTANT PADLOCK

53399 3,50€

0.90 8 48 3168
Kg SUB 11 12 30mm



53400 5,70€

0.20 8 48 499
Kg SUB 11 12 40mm



x2



53401 7,40€

0.35 8 48 499
Kg SUB 11 12 50mm



53402 9,60€

0.05 10 40 499
Kg SUB 11 12 65mm

WITH PROTECTIVE CAP

Download our 2023 spare parts catalogue here!

VAT not included

SLEDGE HAMMER FIBREGLASS SHAFT

52182 24,00€ **2 Kg**
2.20 6 12 504
Kg SUB ff
297mm

52184 43,00€ **4 Kg**
4.31 - 4 128
Kg SUB ff
880mm

52185 55,00€ **6 Kg**
6.97 - 4 72
Kg SUB ff
895mm

52186 72,00€ **8 Kg**
8.68 - 2 78
Kg SUB ff
900mm



HAMMERS

LOCKSMITH HAMMER

51674 7,75€ **505 g**
0.60 6 36 864
Kg SUB ff

52565 11,50€ **1 Kg**
1.13 6 24 720
Kg SUB ff



BALL-PEIN HAMMER

51918 12,50€ **1 Kg**
1.25 6 18 432
Kg SUB ff

51504 8,50€ **454 g**
0.55 4 40 800
Kg SUB ff



ASSORTED HAMMERS - EVA CARBON FIBRE MODULE

15799 28,30€ **10 200**
1.35 - 10 200
Kg SUB ff



DEAD BLOW HAMMER

52180 19,00€ **1,45 Kg** 355mm
1.45 6 12 432
Kg SUB ff

52183 26,20€ **2,30 Kg** 405mm
2.30 6 12 288
Kg SUB ff

52181 22,50€ **1,80 Kg** 370mm
1.81 6 12 300
Kg SUB ff



SOFT FACED HAMMER - NYLON HEAD

52425 33,30€ **Ø 40mm**
0.70 6 12 768
Kg SUB ff

52426 52,00€ **Ø 60mm**
1.50 2 12 288
Kg SUB ff

52427 64,00€ **Ø 70mm**
2.02 2 12 204
Kg SUB ff



REPLACEMENT HEAD

REF.	Ø	Kg	Sub	ff	€
11212	40mm	0,02	5	100	5,00€
11213	60mm	0,08	5	50	10,60€
11214	70mm	0,11	5	100	12,50€



AXE

52188 15,50€

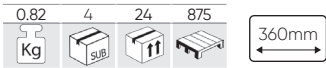

52460 16,60€

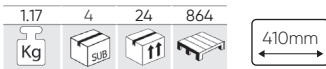

52461 25,70€

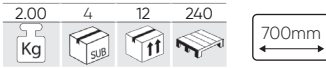

HACKSAW WITH ERGONOMIC HANDLE

52830 24,00€

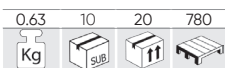

IN 10 UNITS DISPLAY CASE

HACKSAW

52831 18,00€

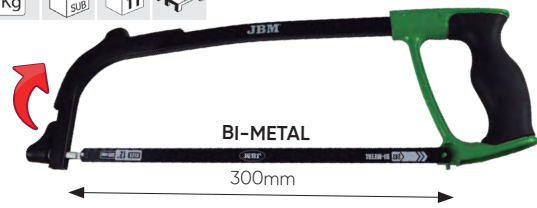
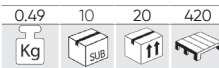

IN 10 UNITS DISPLAY CASE

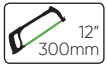

BLADE FOR HACKSAW FOR REF. 52830 / 52831 / 51675

12060 2,50€

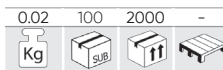

SET OF 5 STEEL FILES

51853 18,00€

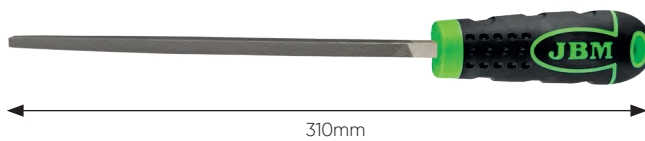
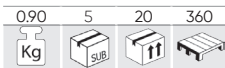

3 PIECES STEEL SCRAPER SET

51951 15,60€



- Ergonomic grip.



4 PCS BODY FILLER APPLICATOR SET

53339 9,50€

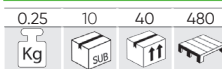

VAT not included

CHISEL WITH HAND GRIP

53120

6,00€

STEEL
45C

0.35 6 24 1200
Kg SUB ff

150mm



53121

7,35€

0.55 6 24 840
Kg SUB ff

250mm

53122

9,50€

0.90 6 12 720
Kg SUB ff

350mm

4 PIECES CHISEL SET

53083

64,00€

STEEL
SNCM+V

1.04 10 20 960
Kg SUB ff

18x125,
21x150,
26x200,
29x250mm



LONG COLD CHISEL SET

54089

17,50€

5
PCS

0.50 10 40 2240
Kg SUB ff

10, 11, 12, 14, 16mm



CHISEL AND PIN PUNCH SET

15737

45,00€

9
PCS

1.70 - 10 200
Kg SUB ff

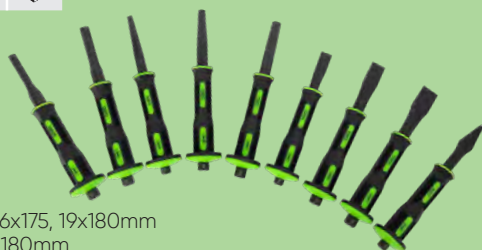

Contents:

Chisel: 12x160, 16x175, 19x180mm
Cape chisel: 6x180mm
Center punch: 6x180, 8x180, 10x180mm
Parallel pin punch: 8x180, 10x180mm



CENTER PUNCH SET

52049

14,00€

STEEL
45C

0.40 10 40 3840
Kg SUB ff

3, 4, 5, 6, 7mm



6 PCS PARALLEL PIN PUNCH SET

53095

20,50€

CrV

0.75 6 24 1152
Kg SUB ff

3, 4, 5, 6, 7, 8mm

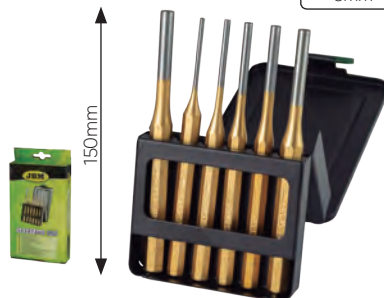

5 PIECES PARALLEL PIN PUNCH SET

54099

13,80€

4, 5, 6, 7, 8mm

0.45 10 40 2240
Kg SUB ff



SWIVEL HEAD HAND RIVETER

53993

77,00€

1.95 5 20 240
Kg SUB ff

- 360° rotating head
- Compact, makes it easy to work in small spaces
- One-handed design

Contains:

- Standard rivet nose bits 2.4mm (3/32") - 3.2mm (1/8") - 4.0mm (5/32") - 4.8mm (3/16")
- Punches for rivet nuts M3x0.5 - M4x0.7 - M5x0.8 - M6x1
- Punches for rivets M6x1 - M5x0,8 - M4x0,7
- 3 wrenches of 5,5x8,5mm - 12x17mm - 15x19mm
- Spindle holder M6x1 - M5x0,8 - M4x0,7 - M3x0,5



M3x0.5
M4x0.7
M5x0.8
M6x1

2,4mm (3/32")
4,0mm (5/32")
4,8mm (3/16")



NUT RIVETER KIT 200MM / 8"

52595 64,00€

1.30 - 10 280
Kg SUB if

300mm

M3, M4, M5, M6

8"



COMPACT RIVETER 200MM / 8"

52462 25,30€

0.55 5 30 600
Kg SUB if

200mm

8"

2,4mm (3/32)
3,2mm (1/8)
4,0mm (5/32)
4,8mm (3/16)

RIVETING PLIERS EVA TRAY FOR CABINET

13667 17,60€

0.83 - 10 360
Kg SUB if



TWO-HANDED RIVETER 300MM / 12"

52463 26,10€

0.74 5 20 240
Kg SUB if

300mm

12"

3,2mm (1/8)
4,0mm (5/32)
4,8mm (3/16)



TWO-HANDED RIVETER 400MM / 16"

52464 42,00€

1.25 5 10 180
Kg SUB if

400mm

16"

2,4mm (3/32)
3,2mm (1/8)
4,0mm (5/32)
4,8mm (3/16)
6,4mm (1/4)



TWO-HANDED RIVET NUT GUN 400MM / 16"

52596 114,00€

3.07 - 5 60
Kg SUB if

400mm

16"

M3, M4, M5, M6, M8, M10, M12

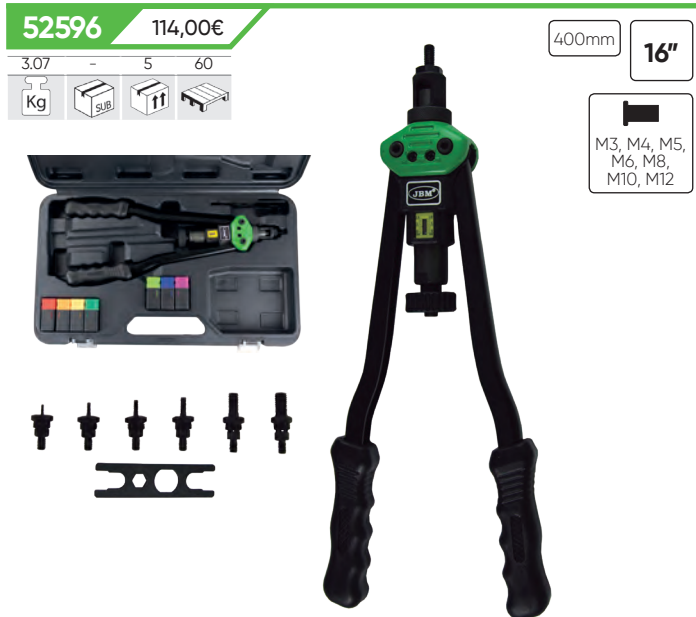

AUTOMATIC RIVET NUT GUN 440MM / 17"

52597 146,00€

3.25 - 5 80
Kg SUB if

440mm

17"

M3, M4, M5, M6, M8, M10, M12



SPARE PART FOR 52595, 52596, 52597



REF.	CHARACTERISTICS	Kg	if	€
13226	M3	0,03	100	4,50€
13227	M4	0,04	100	4,50€
13228	M5	0,04	100	4,50€
13229	M6	0,04	50	4,50€

REF.	CHARACTERISTICS	Kg	if	€
13230	M8	0,04	50	4,50€
13231	M10	0,05	100	4,50€
13232	M12	0,05	100	4,50€

VAT not included

QUICK ACTION HAND RIVETER 10"

53331 31,80€

0,80	5	20	280
Kg	Sub	ff	

250mm 10"

- 2,4mm (3/32)
- 3,2mm (1/8)
- 4,0mm (5/32)
- 4,8mm (3/16)
- 6,4mm (1/4)



LAZY TONG RIVETER 8"

53332 34,50€

1,65	5	10	280
Kg	Sub	ff	

200mm 8"

- 2,4mm (3/32)
- 3,2mm (1/8)
- 4,0mm (5/32)
- 4,8mm (3/16)



RIVETER + PLASTIC RIVET CASE

52609 29,00€

0,45	5	20	300
Kg	Sub	ff	



- Ø 6,6mm x 17,2mm (10 u.)
- Ø 6,3mm x 25,2mm (10 u.)
- Ø 5mm x 17,2mm (10 u.)
- Ø 5mm x 15,8mm (10 u.)



PLASTIC RIVET CASE

REF.	Ø	Kg	Sub	ff	€
13674	6x19,3mm	0,01	25	1.000	0,50€
13675	6x17,8mm	0,01	25	1.000	0,50€
13676	6x25,5mm	0,01	25	1.000	0,50€
13677	6x24,5mm	0,01	25	1.000	0,50€
13678	6x24mm	0,01	25	1.000	0,50€



AIR RIVETER

52575 119,00€

1,75	5	10	140
Kg	Sub	ff	



- 2,4mm (3/32), 3,2mm (1/8)
- 4,0mm (5/32), 4,8mm (3/16)

- Traction: 1586LBS / 720 KGS.
- Length: 9/16" - 14MM.
- Max. 60FT IB / 23-69NM.
- Air consumption: 0.03CFM/0.86L/MIN.
- Air inlet size: 1/4".

- Includes:
- O-Rings
 - Safety cup to collect
 - Spent rivets
 - 2 Multi-tools
 - Quick hitch

- 0,50€
- 0,50€
- 0,50€
- 0,50€



RIVETS AVAILABLE ON PAGE 51,319

72-TEETH RATCHET WITH SOCKETS

54030 18,80€

0,35	6	36	1008
Kg	Sub	ff	

- 1/4" 4, 5, 6, 7, 8, 9, 10, 11, 12, 13mm

54031 19,30€

0,35	6	36	864
Kg	Sub	ff	

- 1/4" 4, 5, 6, 7, 8, 9, 10, 11, 12, 13mm

54028 28,00€

1,30	4	24	432
Kg	Sub	ff	

- 1/2" 10, 11, 12, 13, 14, 15, 16, 17, 18, 19mm

54029 28,00€

1,25	4	24	432
Kg	Sub	ff	

- 1/2" 10, 11, 12, 13, 14, 15, 16, 17, 18, 19mm



3 PIECES STUBBY RATCHET SET

53671 41,00€

0.85 - 10 470

Kg SUB

- Include:
1/4" stubby ratchet handle.
1/2" stubby ratchet handle.
3/8" stubby ratchet handle.

PRESENTATION
IN EVA



72 3 PCS



REPAIRING KIT FOR 1/2" STUBBY RATCHET	REPAIRING KIT FOR 3/8" STUBBY RATCHET	REPAIRING KIT FOR 1/4" STUBBY RATCHET
15140 13,50€	15139 12,00€	15138 10,50€
0.20 Kg	0.15 Kg	0.10 Kg
50	50	50

72-TEETH RATCHET

CHROME FINISH

54022 9,95€

0.15 12 36 2268

Kg SUB

1/4" 145mm

54023 13,50€

0.30 12 24 1440

Kg SUB

3/8" 200mm

54024 17,90€

0.60 12 24 960

Kg SUB

1/2" 255mm

ZINC FINISH

54018 9,85€

0.15 12 36 2016

Kg SUB

1/4" 145mm

54021 13,50€

0.60 12 24 1440

Kg SUB

3/8" 200mm

54019 17,90€

0.60 12 24 864

Kg SUB

1/2" 255mm



12 UNITS IN
DISPLAY CASE



12 UNITS IN
DISPLAY CASE

72-TEETH RATCHET ZINC FINISH

52207 24,20€

0.05 12 240 8400

Kg SUB

1/4"
85mm



12 UNITS IN
DISPLAY CASE

72-TEETH RATCHET

54083 9,75€

0.14 12 24 2592

Kg SUB

1/4"

54084 13,10€

0.30 12 24 1440

Kg SUB

3/8"

54085 17,80€

0.60 12 24 960

Kg SUB

1/2"



12 UNITS IN
DISPLAY CASE

72-TEETH STUBBY RATCHET

54086 9,25€

0.10 12 24 2592

Kg SUB

1/4"



54087 17,30€

0.50 12 24 1008

Kg SUB

1/2"



12 UNITS IN
DISPLAY CASE

VAT not included

SHORT HINGED 72-TEETH RATCHET

52587 39,90€

0.16 12 144 3456



1/4" 175mm

51305 28,90€

0.31 12 48 816



1/2" 170mm



52588 45,00€

0.17 12 144 3456



IN 12 UNITS
DISPLAY CASE

1/2" 175mm

51306 28,10€

0.30 12 48 816



1/4" 175mm



IN 12 UNITS
DISPLAY CASE

1/4" 72-TEETH SWIVEL HEAD RATCHET WITH T-HANDLE

51405 21,10€

0.58 12 24 -



1/4" 145mm



51406 29,20€

0.66 12 24 864



1/2" 280mm



IN 12 UNITS
DISPLAY
CASE

1/2" 72-TEETH DRIVE EXTENDABLE RATCHET

52197 36,30€

1.04 6 12 480



350-490mm

1/2"



180°
ROTATION

EXTENDABLE
HANDLE



IN 6 UNITS
DISPLAY CASE

72-TEETH DRIVE EXTENDABLE RATCHET

53346 18,00€

0.25 6 12 -



1/4" 150-200mm

51307 29,70€

0.92 6 12 456



1/2" 305-445mm



- Forged steel with
heat treatment.

EXTENDABLE
HANDLE

EXTENDABLE



IN 6 UNITS
DISPLAY CASE

IN 6 UNITS
DISPLAY CASE

72-TEETH FLEXIBLE EXTRA LONG DRIVE RATCHET

53886 20,30€

0.27	10	40	1680
Kg	Sub	Box	Tray

1/4" 305mm



1/4" SPARE SET FOR REF. 53886

15149 5,00€

0.05	100
Kg	Box

53887 30,30€

0.68	10	20	700
Kg	Sub	Box	Tray

3/8" 457mm

3/8" SPARE SET FOR REF. 53887

15147 5,00€

0.10	100
Kg	Box

53888 37,90€

1.27	4	16	480
Kg	Sub	Box	Tray

1/2" 609mm

1/2" SPARE SET FOR REF. 53888

15148 5,00€

0.20	100
Kg	Box



72 TEETH EXTRA LONG DRIVE RATCHET

53883 18,40€

0.27	10	40	1680
Kg	Sub	Box	Tray

1/4" 305mm



1/4" SPARE SET FOR REF. 53883

15149 5,00€

0.05	100
Kg	Box

53884 30,20€

0.61	10	20	700
Kg	Sub	Box	Tray

3/8" 457mm

3/8" SPARE SET FOR REF. 53884

15147 5,00€

0.10	100
Kg	Box

53885 35,70€

1.25	4	16	480
Kg	Sub	Box	Tray

1/2" 609mm

1/2" SPARE SET FOR REF. 53885

15148 5,00€

0.20	100
Kg	Box



FLEXIBLE 72-TEETH RATCHET 3/8"

51801 62,00€

0.56	-	40	160
Kg	Sub	Box	Tray

500mm 3/8"

- Very useful for places that are difficult to access.

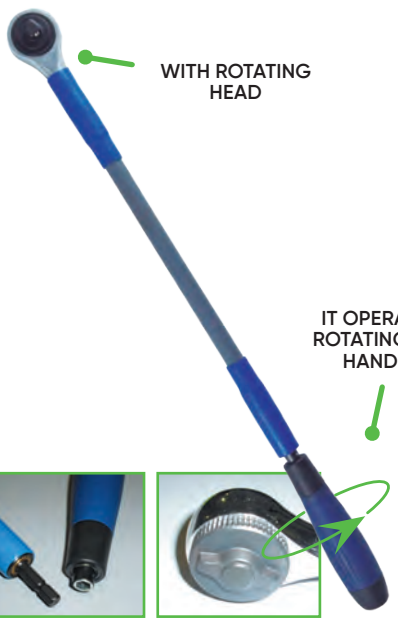

WITH ROTATING HEAD

IT OPERATES ROTATING THE HANDLE



CROSS WRENCH WELDED JOINT

51661 12,00€

1.17	5	20	480
Kg	Sub	Box	Tray

355mm 17, 19, 21mm 1/2"



52880 42,00€

3.75	-	5	100
Kg	Sub	Box	Tray

700mm 24, 27, 32mm 3/4"



52881 17,00€

1.40	-	10	420
Kg	Sub	Box	Tray

400mm 17, 19, 21, 22mm 1/2"



SLIDING T BAR

53478 4,55€

0.50	5	100	1200
Kg	Sub	11	11

1/4" 115mm

53468 8,50€

0.35	6	48	600
Kg	Sub	11	11

1/2" 250mm

53481 27,40€

2.85	-	5	300
Kg	Sub	11	11

1" 550mm



53479 6,40€

0.15	5	50	300
Kg	Sub	11	11

3/8" 200mm

53480 19,90€

1.35	5	10	440
Kg	Sub	11	11

3/4" 460mm



SWIVEL HEAD RATCHETED BREAKER BAR

52524 51,00€

3.60	3	6	180
Kg	Sub	11	11

3/4"

1.020mm



52526 28,40€

1.65	5	10	400
Kg	Sub	11	11

1/2"

600mm



1/2" 11945



1/2" 11946



3/4" 11947



52525 13,80€

0.85	10	20	1400
Kg	Sub	11	11

1/2"

430mm



REF.	"	FOR	Kg	Sub	11	€
11945	1/2"	52526	0,15	25	100	7,00€
11946	1/2"	52525	0,51	100	300	4,50€
11947	3/4"	52524	0,60	10	40	19,00€

5 PIECES 1/4" EXTENSION BARS SET

51447 16,00€

0.34	5	20	960
Kg	Sub	11	11



1/4"

50, 75, 100, 152, 227mm



SPARE PARTS AVAILABLE

REF.	mm	Kg	Sub	11	€
14026	50mm	0,03	5	100	5,50€
14027	75mm	0,04	-	50	5,60€
14028	100mm	0,06	5	100	7,00€
14029	152mm	0,08	-	50	8,50€
14030	227mm	0,11	-	50	9,50€



5 PIECES 1/4" EXTENSION BAR WITH BALL END SET

51805 17,00€

0.33	4	20	640
Kg	Sub	11	11



1/4"

50, 75, 100, 152, 227mm



SPARE PARTS AVAILABLE

REF.	mm	Kg	Sub	11	€
12995	50mm	0,03	5	100	7,00€
12996	75mm	0,04	20	100	7,00€
12997	100mm	0,06	20	100	7,50€
12998	152mm	0,08	5	100	9,00€
12999	227mm	0,11	5	100	9,50€



5 PIECES 1/2" EXTENSION BAR WITH BALL END SET

51448 52,00€

2.38	-	5	270
Kg	Sub	11	11



1/2"

50, 125, 250, 380, 510mm

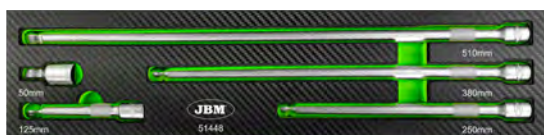

SPARE PARTS AVAILABLE

REF.	mm	Kg	Sub	11	€
14978	50mm	0,09	5	100	7,50€
14979	125mm	0,21	5	50	9,00€
14980	250mm	0,40	5	25	13,00€
14981	380mm	0,62	5	20	22,50€
14982	510mm	0,83	5	10	27,50€



1/2" EXTENDABLE BAR WITH BALL END

51479 31,80€

0.65 12 24 1056

Kg SUB 11 16

260-410mm 1/2"



IN 12 UNITS
DISPLAY CASE



6 POSITIONS

FLEXIBLE 4-CLAW PICK-UP TOOL

51526 9,80€

0.10 12 144 2016

Kg SUB 11 16



500mm Ø 20mm

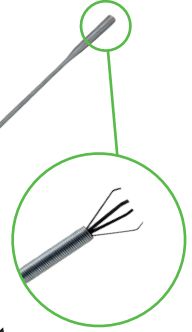

20mm

FLEXIBLE MAGNETIC PICK-UP TOOL WITH LED

52473 9,90€

0.18 10 60 1800

Kg SUB 11 16

x1 545mm Ø 15mm

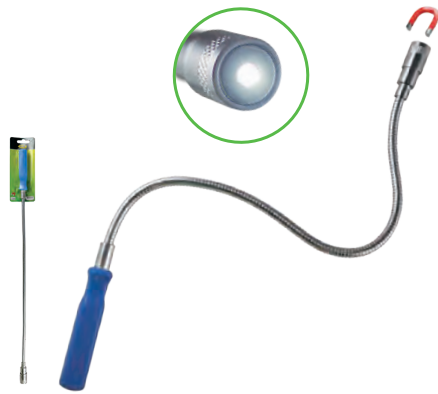

TELESCOPIC MAGNETIC PICK-UP TOOL

52472 4,90€

0.15 12 108 4320

Kg SUB 11 16

Ø 10mm 135-600mm



2,5 Kg

FLEXIBLE MAGNETIC PICK-UP TOOL

51525 9,80€

0.14 10 60 1440

Kg SUB 11 16

500mm Ø 7mm

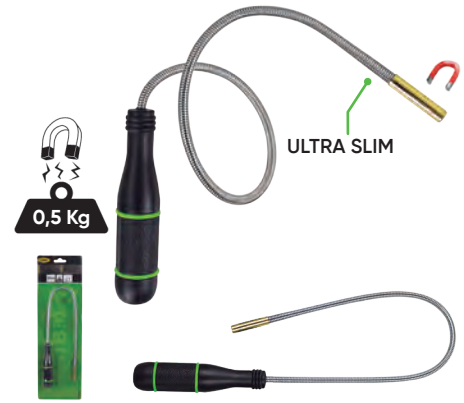

ULTRA SLIM

MAGNETIC PICK-UP TOOL WITH LED

51272 7,50€

0.05 12 72 1512

Kg SUB 11 16

90-810mm Ø 15mm x1



IN 12 UNITS
DISPLAY CASE



5 PIECES MAGNETIC PICK-UP TOOL SET

15706 31,00€

0.55 - 10 240

Kg SUB 11 16

5 PCS LED 360°

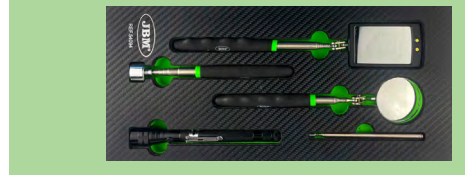

TELESCOPIC INSPECTION MIRROR

52468 5,90€

0.09 12 48 2688

Kg SUB 11 16

280-445mm



Ø 50MM

MAGNETIZER / DEMAGNETIZER

53225 3,50€

0.10 12 96 2880

Kg SUB 11 16

ABS

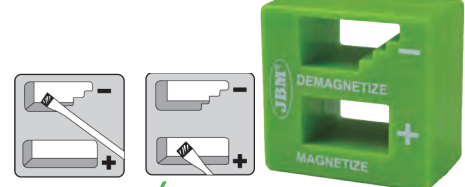

VAT not included

JBM / www.jbmcamp.com

FOLDING KNIFE WITH SEATBELT CUTTER AND WINDOW BREAKING HAMMER

52786 14,60€

0.16 12 60 2100



WITH ANTI-LOCK SYSTEM



TUBE CUTTER

52878 11,20€

0.22 10 50 1500



3-32mm

52879 10,10€

0.24 10 50 1500



3-35mm

53517 9,50€

0.13 10 60 600



Ø max: 30mm

52877 15,80€

0.43 6 48 624



Ø max: 42mm



REF.	DESCRIPTION	FOR	Kg	€
12964	Steel wheel	52878	0,01	1,50€
12965	Steel wheel	52879	0,01	2,00€

TUBE BENDER 6-8-10mm

52905 28,00€

0.50 6 24 360



6, 8, 10mm

ALUMINIUM, COPPER AND STEEL TUBES



MARKED DEGREES



CABLE STRIPPING KNIFE

53591 5,50€

0.10 10 100 -



↑ 28mm
↓ 8mm



8-28mm

- Cutting range: 8-28mm.
- Product length: 170mm.
- Blade length: 20mm.
- Hook depth: 5mm.



MINI WIRE CUTTER

53411 5,00€

0.05 12 120 -



127mm



53411

53412 4,00€

0.05 12 120 -



94mm



53412

TRIM CLIP REMOVER

53385 19,30€

0.15 6 54 1026



CUT



HOLD



FLANGE



- ANGLED TIP:
- Designed to cut / pull clips easily and with no damage.
 - Allows access to difficult areas.

CRIMPING PLIER RATCHET SET WITH 4 JAWS

54254 43,00€

1.10 5 20 300



AUTOMATIC SELF ADJUSTING WIRE STRIPPER

51972 12,00€

0,08-6mm

0.25 10 100 1000



- To strip individual or multiple cables with sections from 0.25 to 2.5mm².
- Automatic adjustment of thickness of stripping for the different sections.
- Several cables with maximum section of 2.5mm² can be stripped at the same time.
- Individual cable starting at section 0.25mm² can be stripped.
- Does not cause damage to lead wire.
- High durability.

TERMINAL PLIERS

FOR INSULATED AND NON-INSULATED TERMINALS

52761 8,00€

9"

0.25 12 72 1800



53932 8,00€

9"

0.25 12 72 1296



WIRE STRIPPER + TERMINAL EVA TRAY FOR CABINET

13669 18,00€

0.61 10

FOR NON-INSULATED TERMINALS

52762 9,00€

8 - 3/4"

0.25 12 72 1800



CABLE CUTTER SCISSORS

52152 13,50€

STAINLESS STEEL

145mm

0.08 12 96 1920



45mm

HEAVY DUTY CABLE CUTTER

53604 118,00€

Maximum cutting section: Ø 550 mm²

3.70 - 5 120



800mm

53603 45,00€

Maximum cutting section: Ø 250 mm²

1.75 - 5 300



550mm

53602 30,50€

Maximum cutting section: Ø 125 mm²

0.60 - 5 300



360mm



53602 53603 53604

BOLT CUTTER

52955 19,80€

0.77 - 20 200



12" 300mm HRC 30 Ø 4-5mm

52957 23,80€

1.47 - 12 360



18" 450mm HRC 30 Ø 6-8mm

52959 42,00€

3.78 - 5 100



30" 750mm HRC 30 Ø 10-13mm

52960 46,00€

5.15 - 5 105



36" 900mm HRC 30 Ø 12-16mm

52956 19,60€

0.95 - 20 200



14" 350mm HRC 30 Ø 5-7mm

52958 28,20€

2.40 - 8 210



24" 600mm HRC 30 Ø 8-10mm



52955 52956 52957 52958 52959 52960

VAT not included

JBM / www.jbmcamp.com

57

STRAIGHT NOSE INTERNAL CIRCLIP PLIER

INTERNAL

53549 14,30€

0.45	5	30	-
Kg	Sub	Box	Tray

13" 330mm



52964 9,45€

0.23	6	60	1440
Kg	Sub	Box	Tray

9" 225mm

51018 7,05€

0.14	5	100	1800
Kg	Sub	Box	Tray

7" 180mm

EXTERNAL

53547 14,70€

0.50	5	30	-
Kg	Sub	Box	Tray

13" 330mm



52966 9,45€

0.28	6	60	1800
Kg	Sub	Box	Tray

9" 225mm

51017 6,80€

0.17	5	100	1800
Kg	Sub	Box	Tray

7" 180mm

CIRCLIP PLIER - 90 DEGREE BEND

INTERNAL

53550 14,70€

0.45	5	30	-
Kg	Sub	Box	Tray

13" 330mm



52965 9,20€

0.24	6	60	1440
Kg	Sub	Box	Tray

9" 225mm

51021 7,05€

0.16	5	100	-
Kg	Sub	Box	Tray

7" 180mm

EXTERNAL

53548 15,60€

0.50	5	30	-
Kg	Sub	Box	Tray

13" 330mm



52967 9,40€

0.24	6	60	1440
Kg	Sub	Box	Tray

9" 225mm

51020 6,65€

0.13	5	100	1600
Kg	Sub	Box	Tray

7" 180mm

4 PIECES 8" CIRCLIP PLIER SET

15454 35,40€

1.10	-	10	300
Kg	Sub	Box	Tray

	Ø	Kg	€
15707	8" INTERNAL CIRCLIP PLIERS (STRAIGHT TIPS)	0,21	10,00€
15708	8" EXTERNAL CIRCLIP PLIERS (STRAIGHT TIPS)	0,22	10,00€
15709	8" INTERNAL CIRCLIP PLIERS (BENT TIPS)	0,21	10,00€
15710	8" EXTERNAL CIRCLIP PLIERS (BENT TIPS)	0,22	10,00€



8"

CIRCLIP PLIER SET WITH 16 REPLACEMENT TIPS WATERPUMP PLIERS

53389 31,50€

1.50	-	10	160
Kg	Sub	Box	Tray

Angles tips: 90° / 45° / 15° / 0° 10"

- Content:
- External circlip plier.
 - Internal circlip plier.
 - 16 different bits with different angled tips.
 - 8 screws.



52052 53,00€

1.88	5	10	400
Kg	Sub	Box	Tray



50567 9,60€

0.34	10	60	1500
Kg	Sub	Box	Tray



EXTRA LONG PLIER

STRAIGHT NOSE

45° BENTS

52846 37,80€

52847 41,00€

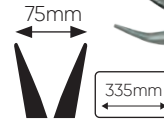
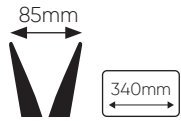
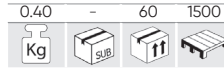
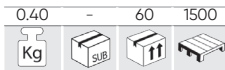

3 PIECES LONG REACH PLIER SET 0°, 45°, 90°

52272 24,60€

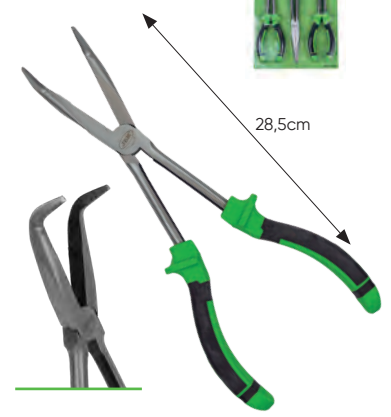
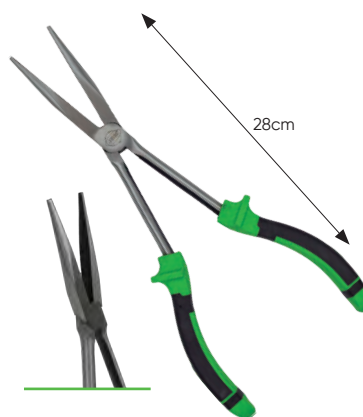
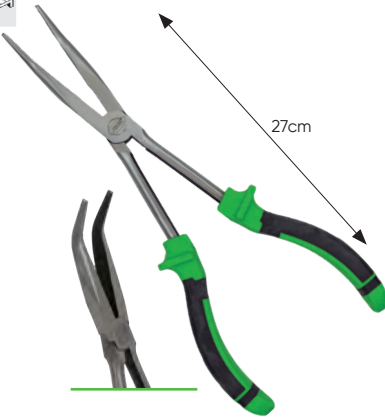
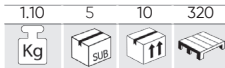

5 PIECES PLIER SET

51812 46,00€

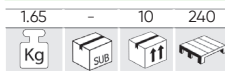

9-IN-1 MULTI TOOL 105MM

52412 5,00€

105mm



CONTAINS

- x2 (-) screwdriver
- x1 phillips screwdriver
- x1 can opener
- x1 bottle opener
- x1 25mm lime
- x1 saw with tape 40mm
- x1 drop point Blade 40mm

VAT not included

HOSE CLAMP PLIERS

53390 34,50€

1.00	10	20	320
Kg	sub	ff	



SPARE PARTS SET FOR 53390

14180	0.01	100
7,90€	Kg	ff

51995 24,50€

0.53	5	40	360
Kg	sub	ff	



SPARE PARTS SET FOR 51995

14179	0.01	100
8,50€	Kg	ff

EXHAUST PIPE CLAMP PLIERS

53396 18,30€

0.50	5	50	-
Kg	sub	ff	



HOSE CLAMP PLIERS CLIC-R

52791 18,00€

0.25	5	50	1500
Kg	sub	ff	



COMBINATION PLIER

53911 8,80€

0.20	6	60	1440
Kg	sub	ff	

160mm

6"

53967 10,20€

0.30	6	60	1440
Kg	sub	ff	

200mm

8"

54015 10,20€

0.20	6	60	1920
Kg	sub	ff	

180mm

7"

CrV



LONG NOSE PLIER 6"

53976 9,00€

0.20	6	60	1440
Kg	sub	ff	

160mm

6"

CrV



SIDE CUTTER PLIER

53905 7,30€

0.20	6	60	1440
Kg	sub	ff	

6" 160mm

53906 8,65€

0.20	6	60	1440
Kg	sub	ff	

7" 184mm

CrV



LONG NOSE PLIERS

53908 7,25€

0.15	6	60	1440
Kg	sub	ff	

6" 160mm

CrV

53909 9,70€

0.20	6	60	1440
Kg	sub	ff	

8" 200mm



HOSE CLAMP PLIER SET

52050 98,00€

3,24 - 4 60



- Use to loosen and readjust Clic or Clic-R type readjustable clamps.
- Tube extraction pliers. Very useful for easy extraction of 5/32" to 1/2" vacuum and fuel tubes.
- Clamp pliers. Allows extraction of auto- adjustable plastic and/or metal clamps with diameters of 18 mm to 47 mm.
- Pliers for swivel jaw clamps with "+" groove.
- Pliers for swivel jaw clamps.
- Pliers for flat band clamps. The jaw rotates 360° to grip at any angle.



REF.	DESCRIPTION	Kg	SUB	QTY	€
13707	swivel jaw spring wire clip pliers	0,25	10	40	14,00€
13708	swivel jaw band clip pliers	0,25	10	40	14,00€
13709	flat band clip pliers	0,24	10	40	14,00€
13710	45° circlip pliers	0,21	10	40	14,00€

REF.	DESCRIPTION	Kg	SUB	QTY	€
52791	hose clamp pliers clic-r	0,27	10	50	18,00€
13712	hose remover pliers	0,21	10	40	14,00€
51995	hose clamp pliers	0,59	5	40	24,50€



CLIC-R COLLAR PLIERS

52619 23,10€

0,55 6 36 648



0-20mm

- Holes of 1/2" on the handles to use as keys.



52812 65,00€

0,85 5 20 500



- 3/8" Female socket for tightening with ratchet.

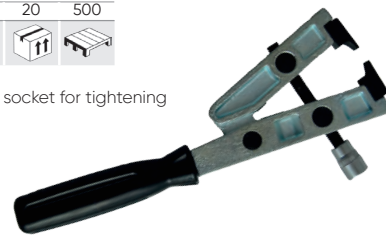

FUEL LINE PLIERS

53487 16,70€

0,30 10 40 960



Audi / VW, Fiat, GM, Mercedes



HOSE CLIP PLIER

52508 38,40€

0,37 10 50 800



0-38mm



52509 36,20€

0,39 10 50 800



22-55mm



240mm

CrMo



VAT not included

JBM / www.jbmcamp.com

NON-MARRING HOOK, PICK AND PRY BAR SET

54142 15,20€

0.10	6	48	1344
Kg	sub	ff	ff

Tools for the removal, cleaning and works with plastic clips, gaskets, cables, electrical connectors, etc.

- It works with soft materials
- Does not scratch the paint

6 PCS



Contents:
2 hook tips
2 straight tips
2 angled tips
6 tips with levers



2PCS PICK AND HOOK SET

52852 6,80€

0.06	25	100	3200
Kg	sub	ff	ff

- For the extraction of "O-rings".



12 PIECE HOLLOW PUNCH SET

52885 18,00€

1.10	5	20	600
Kg	sub	ff	ff

3, 4, 5, 6, 7, 8, 9, 10,
12, 14, 16, 19mm

12 PCS



BRUSHES

52760 4,10€

0.09	6	120	2160
Kg	sub	ff	ff



BRAKE SHOE SPRING PLIERS

52625 9,00€

0.35	6	48	1824
Kg	sub	ff	ff

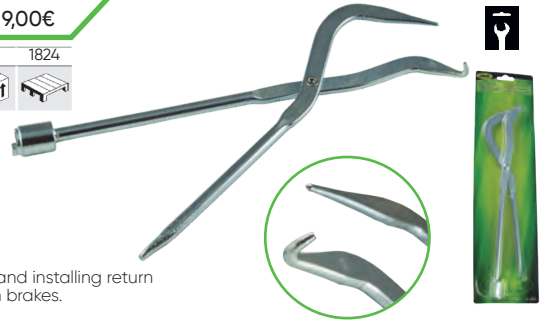

- For removing and installing return springs on drum brakes.

WHEEL WEIGHT PLIERS

51355 19,00€

0.45	5	50	-
Kg	sub	ff	ff

- Extracts easily and replaces the counterweight.
- Cuts and folds easily.
- Made of heat reinforced steel.
- Includes ergonomic handle.



HEAVY DUTY STAPLER

53589 12,00€

0.55	20	40	920
Kg	sub	ff	ff



1008J-1

1000 PCS STAPLE
PACK FOR REF. 53589

14167	0.10	100
2,50€	Kg	ff

LEATHER PUNCH PLIERS

52638 9,95€

0.35	5	50	1800
Kg	sub	ff	ff

Ø 2, 2.5, 3,
3.5, 4, 4.5mm



ADJUSTABLE C-SPANNER SET

53654 81,00€

1.40 - 5 180



- This set includes 3 combined hook/pin, 3 adaptors and 2 spare pins.
- Their combination allows to work with nut diameters from 35mm to 120mm.

8
PCS

35-60, 60-90,
90-120mm

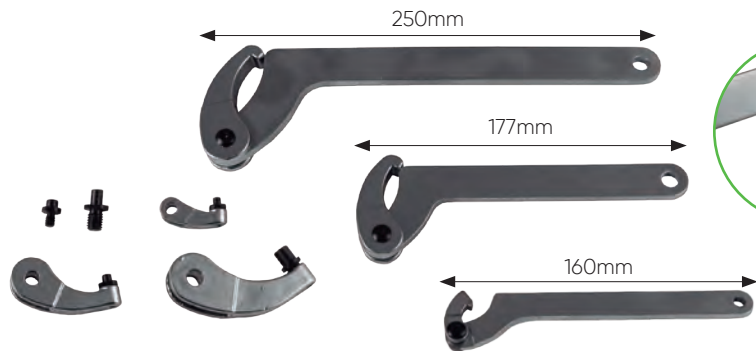

4 PIECES NUT SPLITTER SET

53524 51,00€

1.70 5 10 320



9-12, 12-16,
16-22, 22-27mm

4
PCS

SPARE PARTS AVAILABLE

REF.	DESCRIPTION	Kg	SUB	11	€
14049	9-12mm	0,11	50	8,00€	
14050	12-16mm	0,2	50	10,50€	
14051	16-22mm	0,44	5 20	18,00€	
14052	22-27mm	0,65	5 20	19,50€	



ADJUSTABLE WRENCH

MODEL 3

53639 28,60€

0.15 6 96 576



6"

150mm

53640 34,40€

0.28 6 72 504



8"

200mm

53641 41,00€

0.50 6 36 1151



10"

250mm



53642 54,00€

0.83 6 10 1200



12"

300mm

53643 92,00€

1.53 - 12 336



16"

400mm



MODEL 1

51798 39,60€

1.90 3 12 480



18"

53mm

52424 64,00€

3.75 - 5 250



24"

62mm



MODEL 2

51795 9,00€

0.28 6 60 3600



8"

22mm



51796 14,00€

0.48 6 36 2400



10"

28mm



51797 18,00€

0.71 6 24 960



12"

37mm



51796
51797

PIPE WRENCH

52235 11,00€

0,90 6 24 1140



12" 300mm 50mm



52236 13,30€

1,09 6 24 760



14" 350mm 60mm

52237 18,10€

1,75 4 12 720



18" 450mm 70mm

52238 24,90€

2,50 2 8 600



24" 600mm 75mm

53210 48,00€

4,95 - 4 96



36" 915mm 100mm

ALUMINIUM ALLOY PIPE WRENCH

53070 16,20€

0,68 6 24 900



12" 270mm



53071 26,10€

0,92 4 12 900



14" 320mm

53072 31,60€

1,35 4 12 900



18" 410mm

53073 50,00€

2,05 2 8 1000



24"

ADJUSTABLE BAR CLAMP

52349 22,10€

90x200mm

1,25 - 10 480



52354 34,40€

120x500mm

2,41 - 6 300



52350 22,60€

90x300mm

1,41 - 10 540

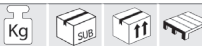

52355 36,60€

120x600mm

2,62 - 4 300



52351 25,40€

90x400mm

1,60 - 10 480



52357 54,00€

150x800mm

4,60 - 5 125



52352 32,40€

120x300mm

1,99 - 10 360



52358 63,00€

150x1.000mm

5,35 - 5 120



52353 33,40€

120x400mm

2,10 - 10 350

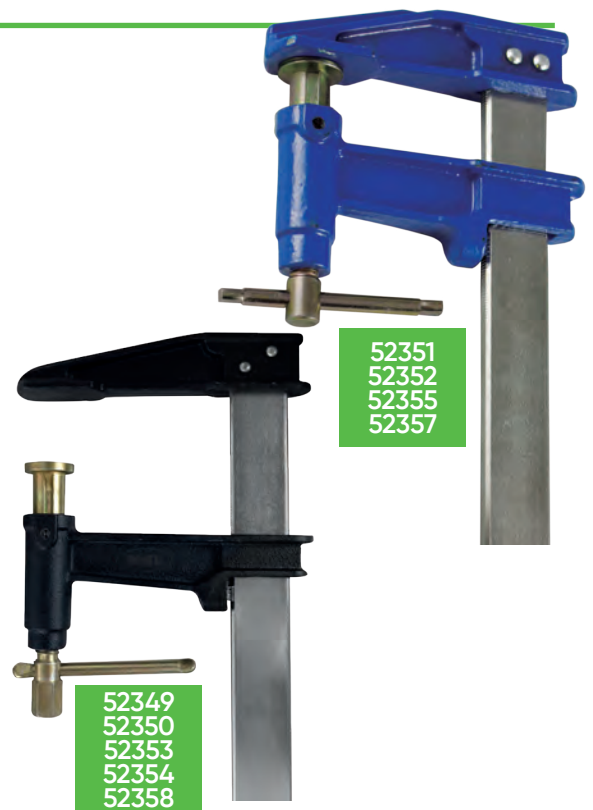

52351
52352
52355
52357

52349
52350
52353
52354
52358



WORKSHOP FURNITURE

- 66 TOOL TROLLEYS
- 75 TOOL SETS
- 80 ACCESSORIES FOR TROLLEY
- 81 CABINETS AND CARTS
- 81 WORK BENCHE ACCESSORIES
- 82 WORK BENCHES
- 84 MODULAR TOOL BOXES / CANTILEVERS
- 85 ADJUSTABLE SEATS / MECHANIC'S CREEPER
- 86 VICES / ANVILS

TOOL TROLLEY WITH 12 DRAWERS

53939 1.280,00€

53868 1.090,00€

172 PCS

98.70	-	1	4
Kg	Sub	Up	Down

83.50	-	1	4
Kg	Sub	Up	Down

FULL

EMPTY

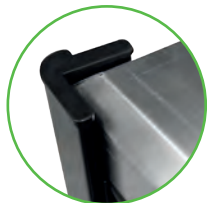

SIDE PROTECTION



CENTRAL LOCKING SYSTEM



HEAVY DUTY HANDLE



TAB LOCK IN EACH INDIVIDUAL DRAWER

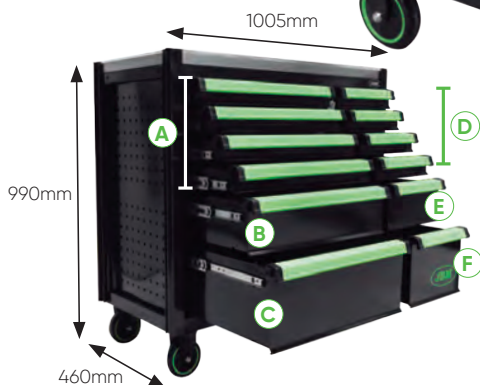

EVA TOOL SETS:
WITH 4 MODULES IN
CARBON FIBER FINISH

53708 325,00€

15.20	-	1	24
Kg	Sub	Up	Down

ACCESSORIES
AND SPARE PARTS
page 80

INNER MEASURES 1ST COLUMN

SMALL DRAWERS (x4)



MEDIUM DRAWERS (x1)

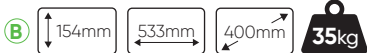

BIG DRAWER (x1)

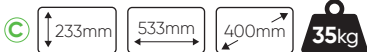

INNER MEASURES 2ND COLUMN

SMALL DRAWERS (x4)



MEDIUM DRAWERS (x1)



BIG DRAWER (x1)



1st tray: 14296 118,00€

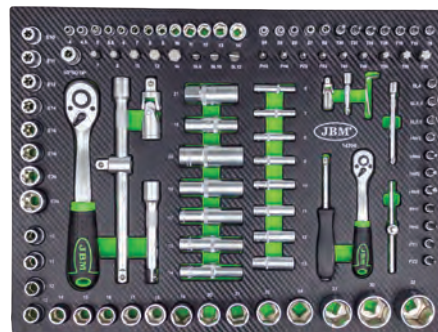

2nd Tray: 14297 87,00€



3rd Tray: 14298 51,50€



4th Tray: 14299 87,00€



TOOL TROLLEY WITH 7 DRAWERS XL

53912 1.280,00€	53869 990,00€	53913 1.280,00€	53870 990,00€	199 PCS
74,50 - - 4 FULL	74,50 - 1 4 EMPTY	74,50 - - 4 FULL	74,50 - 1 4 EMPTY	

CENTRAL LOCKING SYSTEM

STAINLESS STEEL WORK SURFACE

ERGONOMIC, SOFT AND NON-SLIP GRIP

PERFORATED PANELS FOR ACCESSORIES

EASY TO MOVE AND SECURE: SWIVEL WHEELS, 2 WITH BRAKE

TAB LOCK IN EACH INDIVIDUAL DRAWER

INNER MEASURES

SMALL DRAWERS (x5)			BIG DRAWERS (x2)		
74mm	705mm	400mm	151,5mm	705mm	400mm
25kg			35kg		

980mm (width)
984mm (height)
510mm (depth)

ASSORTED EVA TOOL SETS: **XL** **ACCESSORIES AND SPARE PARTS** page 80

2nd Tray: 14296 118,00€	15122 74,00€	1st tray: 14297 87,00€	15161 62,00€
4th Tray: 14298 51,50€	15155 59,00€	3rd Tray: 14299 87,00€	15514 9,35€

VAT not included

CABINETS

TOOL TROLLEY WITH 7 DRAWERS

53763	890,00€	68.00 Kg	-	1	4	FULL
53764	680,00€	56.50 Kg	-	1	4	EMPTY
53765	890,00€	68.00 Kg	-	1	4	FULL

53766	680,00€	56.50 Kg	-	1	4	EMPTY
53900	890,00€	68.00 Kg	-	-	4	FULL
53901	680,00€	56.50 Kg	-	1	4	EMPTY

172 PCS

350Kg



HIGH QUALITY

- ✓ RESISTANT TO HEAVY LOADS
- ✓ LIGHT AND EASY TO MOVE
- ✓ WELL ORGANIZED TOOLS IN EVA MODULES
- ✓ ROBUST AND DURABLE CONSTRUCTION

PERFORATED PANELS FOR ACCESSORIES



TAB LOCK IN EACH INDIVIDUAL DRAWER



CENTRAL LOCKING SYSTEM

2 FIXED WHEELS AND 2 SWIVEL WHEELS, 2 WITH BRAKE

EVA TOOL SETS: WITH 4 MODULES IN CARBON FIBER FINISH

53708	325,00€	15.20 Kg	-	1	24
--------------	---------	----------	---	---	----

1st tray: 14296 118,00€

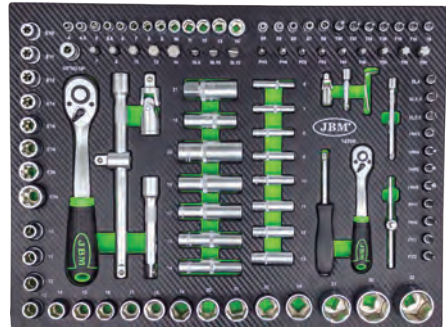

ACCESSORIES AND SPARE PARTS

page 80



SMALL DRAWER (x6)	74mm	533mm	400mm	35Kg
BIG DRAWER (x1)	153mm	533mm	400mm	35Kg

DRAWER LOADING CAPACITY: 40KG.
TOTAL LOADING CAPACITY: 125KG.

2nd Tray: 14297 87,00€

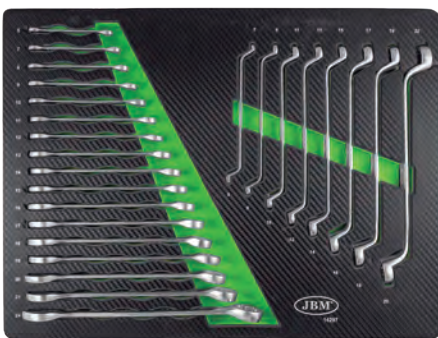

3rd Tray: 14298 51,50€

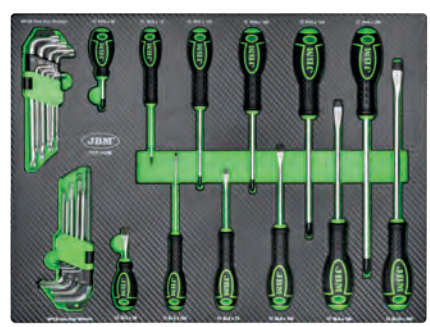

4th Tray: 14299 87,00€



TOOL TROLLEY WITH 7 DRAWERS

53661 890,00€

71,50 Kg 1 SUB 1 4 FULL

53686 890,00€

72,50 Kg 1 SUB 1 4 FULL

53761 680,00€

52,50 Kg 1 SUB 1 4 EMPTY

53762 680,00€

55,50 Kg 1 SUB 1 4 EMPTY

53767 890,00€

64,00 Kg 1 SUB 1 4 FULL

53904 890,00€

72,00 Kg 1 SUB 1 4 FULL

53768 680,00€

56,00 Kg 1 SUB 1 4 EMPTY

54006 680,00€

55,00 Kg 1 SUB 1 4 EMPTY



172 PCS
300 Kg

CABINETS

ACCESSORIES AND SPARE PARTS
page 80

WITH 4 MODULES IN CARBON FIBER FINISH

EVA TOOL SETS:

53708 325,00€

15,20 Kg 1 SUB 1 24

1st tray: 14296 118,00€



1/2" x1	5/16
1/2" x5	14, 15, 17, 19 y 22 mm
1/2" x17	10, 11, 12, 13, 14, 15, 16, 17, 18, 19, 20, 21, 22, 24, 27, 30 y 32 mm
1/2" x8	E10, E11, E12, E14, E16, E18, E20 y E24
1/2" x2	16, 21
x2	5", 10"
1/2" x1	3/8" 1/2"
1/4"	
x18	1,2
	3,4,5,6 mm
	4,5,5,6,5 mm
	8,10,15,20,25,27,30 mm
1/4"	
1/4"	
1/4"	
x2	2", 3"
x13	4, 4,5, 5, 5,5, 6, 7, 8, 9, 10, 11, 12, 13 y 14 mm
1/4" x8	6, 7, 8, 9, 10, 11, 12, 13 mm
1/4" x5	E4, E5, E6, E7 y E8
	7, 8, 10, 12, 14 mm
	8, 10, 12 mm
8mm x17	3,4
	3,4
	40, 45, 50, 55, 60 mm
x3	1,5, 2, 2,5 mm

2nd Tray: 14297 87,00€



6x7 8x9 10x11 12x13 14x15 16x17 18x19 20x22 m
6 7 8 9 10 11 12 13 14 15 16 17 18 19 20 21 22

3rd Tray: 14298 51,50€



x6	PH2x38, PH0x75, PH1x100, PH2x100, PH3x150, PH4x200
x4	SL6x38, SL3x100, SL8x150, SL10x200
x9	
x9	

4th Tray: 14299 87,00€



450g
35mm
10"
8"
10"
7,5"
8"
3m



2 LOCKABLE WHEELS

CENTRAL LOCKING SYSTEM

SMALL DRAWER (X5)



BIG DRAWER (X2)



DRAWER LOADING CAPACITY: 35KG.
TOTAL LOADING CAPACITY: 300KG.



VAT not included

7 DRAWER TOOL TROLLEY - SPECIAL FOR TRUCKS

54240 1.887,00€

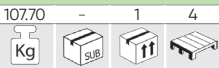

54237 1.887,00€

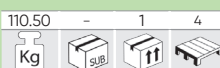

54238 1.887,00€

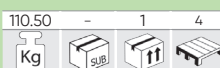

54239 1.887,00€



TRUCK REPAIR TOOL SET

54134 1.415,00€



15734 288,50€



	1kg
	24, 27, 30, 32, 36, 41mm
	3/4" 500mm
	3/4" 500mm

15732 293,50€



	10, 13, 17 mm
	10x11, 12x13, 14x17mm
	E10xE12, E14xE18, E20xE24
	8x10, 11x13, 14x15, 16x17, 18x19mm
	27, 30, 32, 36mm
	10, 13, 17, 19mm

15731 214,00€



	6x7, 8x9, 10x11, 12x13, 14x15, 16x17, 18x19, 20x22, 21x23, 24x27, 25x28, 30x32mm
	6, 7, 8, 10, 11, 12, 13, 14, 15, 17, 19, 22, 24mm

15736 488,50€



	1/2" 78mm	13,14,15,16,17,18,19,21,22,24
	3/4" 110mm	22,24,27,30,32,33,36,38,46mm
	1/2" 90mm	51,60mm
	1/2" T40,T45,T50,T60,T70	
	1/2" H6,H8,H14,H17	
	3/4" T80,T90,T100	
	1/2"(M)x3/4"(H) 3/4"(M) x1/2"(H)	
	1/2" 3/4"	
		125mm
	1/2" 40mm	M18

15735 152,00€



	250mm
	6" - 160mm
	7" - 180mm
	90° 300mm
	45° 300mm
	0° 300mm
	220mm
	330mm
	330mm
	330mm

15730 289,00€



	55mm	H5, H6, H7, H8, H10, H12
	65mm	H14
	70mm	H16, H17, H18, H18, H20
	30mm	H4, H5, H6, H7, H8, H10, H12
	75mm	M5, M6, M8, M10, M12
		T20, T25, T30
		T40, T45, T50, T55
		H4, H5, H6, H7, H8, H10, H12
		M5, M6, M8, M10, M12
		T20, T25, T30
		T40, T45, T50, T55

15733 113,00€



	PH0*75mmL
	PH1*75mmL
	PH2*100mmL
	PH3*38mmL
	PH3*150mmL
	PH4*200mmL
	SL3.5*75mmL
	SL5*75mmL
	SL6*100mmL
	SL6*38mmL
	SL8*150mmL
	SL9.5*200mmL
	10x11, 12x13, 14x15mm
	10x11, 12x13, 14x15, 16x17, 18x19mm

	1/2" T2	
	1/2" X9	E10, E11, E12, E14, E16, E18, E20, E22, E24
	1/2" X10	10, 11, 12, 13, 14, 15, 16, 17, 18, 19mm
	1/2" X3	50, 125, 250mm
	1/2" X1	430mm
	1/2" X1	10mm

	3/4" X5	21, 24, 27, 34, 36mm
	3/4" X4	24, 30, 32, 36 mm
		1/2X10mm 3/8x10mm
		1/2x10mm 3/8x10mm
	3/8"	10mm
	1/4"	300, 380, 450mm

TOOL TROLLEY WITH 7 DRAWERS

54236 1.856,00€

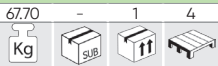

54233 1.856,00€

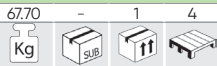

54234 1.856,00€

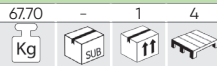

54235 1.856,00€



- x1** EVA INSULATED TOOL MODULE VDE 26 PCS
- x1** LASER THERMOMETER -50°C TO 550°C
- x1** INSULATING FACE SHIELD FOR VOLTAGE WORK
- x1** 7 DRAWER EMPTY CABINET - GREEN
- x1** INSULATED RESCUE STICK - 45KV
- x1** INSULATION TESTER
- x1** INSULATING GLOVES FOR VOLTAGE WORK
- x1** INSULATING MAT CLASS 0
- x8** PLASTIC CARABINER - BLACK
- x4** PVC CHAIN - 5M YELLOW/BLACK
- x4** PVC CHAIN POST-YELLOW / BLACK

Trolley specifically designed to cover all basic needs derived from maintenance and service of hybrid and fully electric vehicles, as well as for high-tension jobs



54093 / 441,00€
EVA INSULATED TOOL MODULE VDE 26 PCS

54132 / 190,00€
INSULATING FACE SHIELD FOR VOLTAGE WORK

52162 / 38,00€
LASER THERMOMETER -50°C TO 550°C

54006 / 680,00€
7 DRAWER EMPTY CABINET - GREEN

54241 / 120,00€
INSULATED RESCUE STICK - 45KV

54130 / 58,00€
INSULATING GLOVES FOR VOLTAGE WORK T.9

54114 / 248,00€
INSULATION TESTER

53942 / 0,50€
x8 PLASTIC CARABINER - BLACK

53941 / 6,05€
x4 PVC CHAIN - 5M YELLOW/BLACK

53940 / 13,20€
x4 PVC CHAIN POST-YELLOW / BLACK

54129 / 110,00€
INSULATING MAT CLASS 0



7 DRAWER TOOL TROLLEY - TIMING TOOL SET INCLUDED

53951 1.794,00€

53952 1.794,00€

53775 1.109,00€

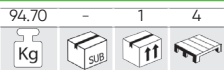

6 PIECES TIMING TOOL SET

GASOLINA/PETROL

GASOIL/DIESEL

1St tray: **53769** 178,00€

RENAULT / NISSAN / OPEL / VOLVO



2St tray: **53770** 198,00€

FORD / SEAT / VOLKSWAGEN / MAZDA / VOLVO



3rd Tray: **53771** 158,00€

FIAT / FORD / CITROËN / PEUGEOT



pg.244

5th Tray: **53773** 298,00€

FIAT / ALFA / LANCIA / OPEL / SUZUKI / FORD



6rd Tray: **53774** 190,00€

OPEL / CHEVROLET / SAAB / FIAT / LANCIA / SUZUKI / FORD



4St tray: **53772** 229,00€

FORD / VAG / MAZDA / VOLVO

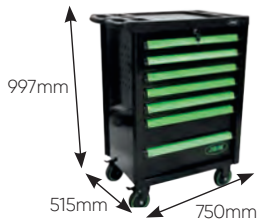

+ INFORMATION OF EACH SET IN TIMING TOOLS, page 238



Choose the color of the cabinet you want and fill it with

AUTO BODY REPAIR TOOLS or MAINTENANCE TOOLS

7 DRAWER TOOL TROLLEY - SHEET METAL WORK

53577 990,00€	53579 990,00€	53580 990,00€	53578 990,00€	256 PCS
74,50 - 1 2	74,50 - 1 2	74,50 - 1 2	74,50 - - -	
Kg SUB	Kg SUB	Kg SUB	Kg SUB	

1st tray:

14059 62,00€ NYLON LEVER SET TRAY



2nd Tray:

14060 65,00€ HAMMERS SET TRAY



3rd Tray:

14061 93,00€ JAWS TRAY



4th Tray:

14062 100,00€ SUCTION LIFTER AND WINDSHIELD REMOVAL TOOL SET TRAY



5th Tray:

14063 119,00€ DENT TOOL KIT TRAY



6th Tray:

14064 39,50€ LOCK-OUT TOOL SET TRAY

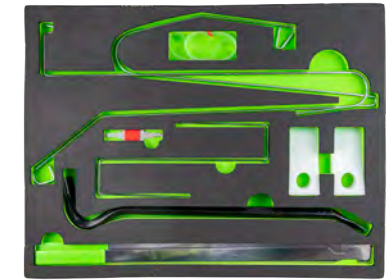

TOOL TROLLEY WITH 7 DRAWERS SPECIAL MAINTENANCE

53514 990,00€	53556 990,00€	53557 990,00€	256 PCS
74,50 - 1 2	74,50 - 1 2	74,50 - 1 2	
Kg SUB	Kg SUB	Kg SUB	

53469

613,00€

SET OF 5 TRAYS FOR OIL CHANGE TOOL CABINET:

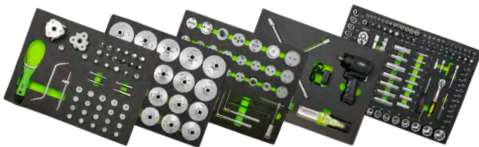

1st tray:

14141 105,00€ OIL FILTER WRENCH SET



2nd Tray:

14142 109,00€ BRAKE PISTONS RETRACTING TOOL SET

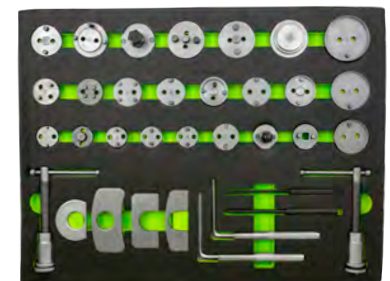

3rd Tray:

14143 124,00€ OIL FILTER TOOLS + OIL DRAIN PLUG

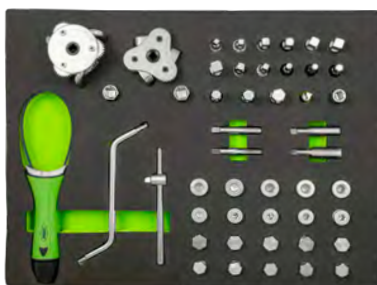

4th Tray:

14144 304,00€ WHEELS TRAY: IMPACT WRENCH + SOCKETS



5th Tray:

14296 118,00€ 108 PCS HEX. SOCKETS

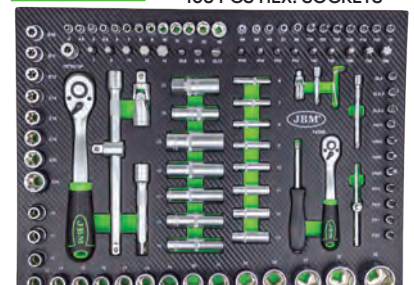

TOOL TROLLEY WITH 7 DRAWERS WITH OR WITHOUT ASSORTED TOOLS

52393 1.180,00€

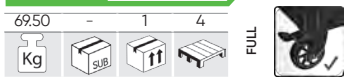

52172 780,00€

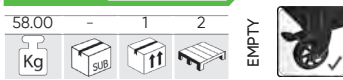

- Wheels without assembly.

- Metal thickness:
Drawer: 0,8mm
Frame: 1mm

179
PCS



ANTI-SLIP RUBBER SURFACE

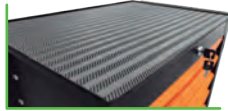

CENTRAL LOCKING SYSTEM



WHEELS WITH BRAKE SYSTEM



125x50mm

INNER MEASURES

SMALL DRAWERS (x5)



BIG DRAWERS (x2)



EVA TOOL SETS:

53708 325,00€

1st tray: **14296** 118,00€

2nd Tray: **14297** 87,00€

3rd Tray: **14298** 51,50€

4th Tray: **14299** 87,00€

WITH 4 MODULES IN CARBON FIBER FINISH



TOOL TROLLEY WITH 9 DRAWERS

53867 1.095,00€

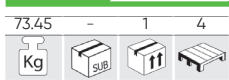

ACCESSORIES AND SPARE PARTS
page 80

WITH SEPARATORS



FREE ORGANIZATION

18
PCS

INCLUDED IN THE CABINET

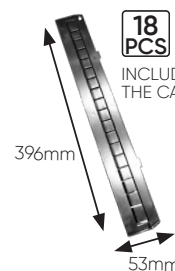

21
PCS

INCLUDED IN THE CABINET

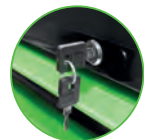

YOU MAY ALSO LIKE...

REF.	mm	Kg	PCS	€
15070	67x53mm	0,05	200	0,50€
15071	103x53mm	0,05	200	0,60€
15072	138x53mm	0,05	200	0,70€
15074	210x53mm	0,10	200	1,00€
15075	280x53mm	0,10	200	1,20€

15076 0,30 50
3,50€ Kg

15073 0,05 200
1,00€ Kg

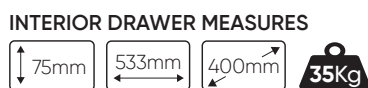

74

CABINET WITH 1 DRAWER

53866

424,00€

35.00	-	1	4
Kg	Sub	ff	



350Kg



ACCESSORIES
AND SPARE PARTS
page 80

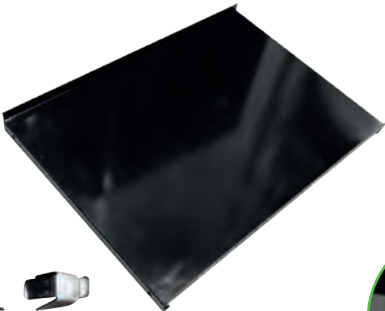

ADJUSTABLE TRAY /
DIVIDER

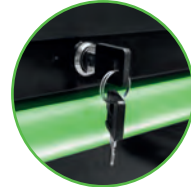

CENTRAL LOCKING
SYSTEM



ANTI-SLIP RUBBER
SURFACE



INTERIOR DRAWER MEASURES

75mm	533mm	400mm	35Kg
------	-------	-------	------



TOOL SETS

EVA TRAY DRAIN PLUG KEY SET

15084

68,00€

1.70	-	-	-
Kg	Sub	ff	

CARBON FIBER FINISH MODULE

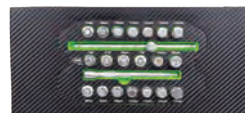

30mm	380mm	175mm
------	-------	-------

YOU MAY ALSO LIKE...

15018	1.45	10
46,00€	Kg	ff

EMPTY TRAY FOR
15018

15083	8,50€
-------	-------

0.05	-	20	480
------	---	----	-----

0.2	-	1	1
-----	---	---	---

0.2	-	1	1
-----	---	---	---

0.2	-	1	1
-----	---	---	---

0.2	-	1	1
-----	---	---	---

0.2	-	1	1
-----	---	---	---

CONTAINS

	x2	5/16", 3/8"
	x7	7, 8, 10, 11, 12, 13, 14mm
	x1	10mm
	x1	10mm
	x7	8, 9, 10, 12, 13, 14, 17mm
	x1	T45
	x1	M16
	x1	200mm
	x1	150mm



Also suitable for oil pans
53873 and 53874.

VAT not included

JBM / www.jbmcamp.com

DRAWER EVA INSERT TRAY TOOL SETS 175x30x380mm

TOOL SETS



15734	288,50€	12,00 Kg	2	48
15732	293,50€	12,00 Kg	2	48
15731	214,00€	12,00 Kg	2	48
15735	152,00€	10,00 Kg	2	48

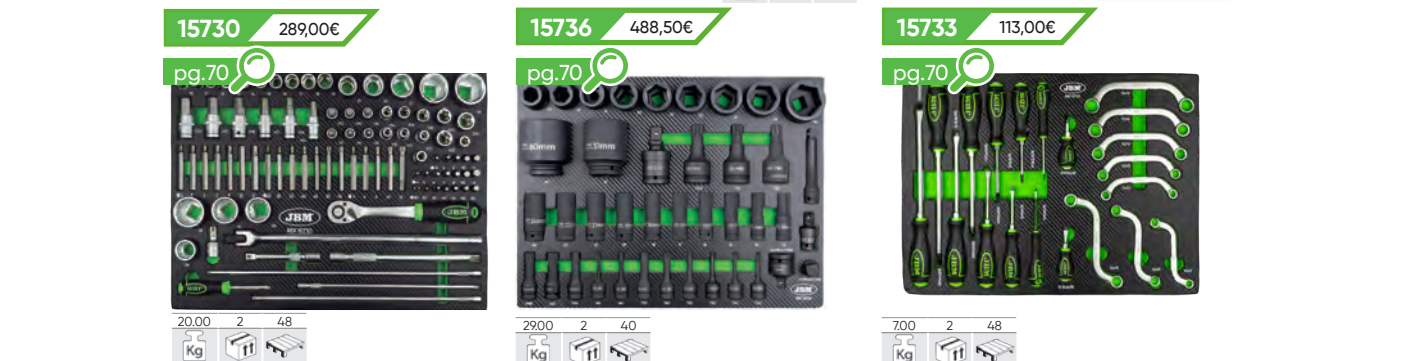

15730	289,00€	20,00 Kg	2	48
15736	488,50€	29,00 Kg	2	40
15733	113,00€	7,00 Kg	2	48

4 TRAY EVA TRAY IN CARBON FIBER FINISH SET

53708	325,00€	30mm	525mm	380mm	15,20 Kg	-	1	24
-------	---------	------	-------	-------	----------	---	---	----



14296	118,00€	6,05 Kg	4	80
-------	---------	---------	---	----



14297	87,00€	3,30 Kg	4	96
-------	--------	---------	---	----

14296	1/2" x17	10, 11, 12, 13, 14, 15, 16, 17, 18, 19, 20, 21, 22, 24, 27, 30, 32mm
	1/4" x13	4, 4.5, 5, 5.5, 6, 7, 8, 9, 10, 11, 12, 13, 14mm
	1/2" x5	14, 15, 17, 19, 22mm
	1/4" x8	6, 7, 8, 9, 10, 11, 12, 13mm
	1/2" x8	E10, E11, E12, E14, E16, E18, E20, E24
	1/4" x5	E4, E5, E6, E7, E8
	7Z x2	1/2" - 1/4"
	1/2" x2	125, 250mm
	1/4" x2	50, 100mm
	x2	
	1/2" x1	
	1/2" x2	16, 21mm
	1/2" x1	8mm
	x3	1.5, 2, 2.5mm
	x1	1/4"
	x1	1/4"
	x2	PH3, PH4
	x2	PZ3, PZ4
	8mm x5	7, 8, 10, 12, 14mm
	x3	SL8, SL10, SL12
	x5	T40, T45, T50, T55, T60
	x2	PH1, PH2
	x2	PZ1, PZ2
	1/4" x4	3, 4, 5, 6mm
	x3	SL4, SL5.5, SL6.5
	x8	T8, T10, T15, T20, T25, T27, T30



14298	51,50€	2,10 Kg	4	96
-------	--------	---------	---	----



14299	87,00€	3,25 Kg	4	96
-------	--------	---------	---	----

14298	PH0x75, PH1 x 100, PH2 x 100, PH3 x 150, PH4 x 200
	6, 7, 8, 10, 11, 12, 13, 14, 15, 17, 19, 22mm
	2x38mm
	6x38mm
	1.5, 2, 2.5, 3, 4, 5, 6, 8, 10mm
	TX10, 15, 20, 25, 27, 30, 40, 45, 50

14297	6x7, 8x9, 10x11, 12x13, 14x15, 16x17, 18x19, 20x22mm
	6, 7, 8, 10, 11, 12, 13, 14, 15, 17, 19, 22mm

14299	x1	8"
	x1	10"
	10"	7.5"
	8"	3m
	8"	

EVA MODULES SET WITH CARBON FIBER FINISH

210x50x120mm



1512 74,00€

1.70 10 200
Kg H mm

8, 9, 10, 11, 12, 13, 14, 15, 16, 17, 18, 19mm



1515 59,00€

2.45 10 180
Kg H mm

8, 10, 11, 12, 13, 14, 15, 16, 17, 18, 19mm



1516 70,00€

2.05 10 180
Kg H mm

21x23, 24x27, 25x28, 30x32 mm



1517 42,00€

0.95 10 300
Kg H mm

6x8, 10x12, 13c14, 15x17, 19x21, 22x24 mm



1518 59,00€

1.30 10 240
Kg H mm

8, 10, 11, 13, 14, 17, 19 mm



15159 44,00€

0.75 10 300
Kg H mm

8x10, 11x13, 14x15, 17x19, 20x22 mm



53943 21,50€

0.80 10 240
Kg H mm

PH4x200, PH3x150, PH2x100, PH2x38 PH1x80, PH0x120, PH1x100



53944 19,50€

0.80 10 240
Kg H mm

SL9x200, SL4x125, SL5x100, SL5x80, SL6x38, SL6x100, SL8x150mm



53945 18,90€

0.60 10 240
Kg H mm

T8x75, T9x75, T10x75, T15x75, T20x75, T25x100, T27x100



54158 38,00€

1.70 8 200
Kg H mm

3/8"	x1	10mm
1/2"	x1	10mm
30mm	x7	4, 5, 6, 7, 8, 10, 12mm
75mm	x7	4, 5, 6, 7, 8, 10, 12mm
30mm	x8	T20, T25, T30, T40, T45, T50, T55, T60
75mm	x8	T20, T25, T30, T40, T45, T50, T55, T60
30mm	x5	M5, M6, M8, M10, M12
75mm	x5	M5, M6, M8, M10, M12



15160 42,00€

0.80 10 300
Kg H mm

8x9, 10x11, 12x13, 14x15, 16x17, 18x19 mm



15161 62,00€

2.10 10 180
Kg H mm

27, 29, 30, 32 mm



15316 58,00€

0.85 10 260
Kg H mm

8, 9, 10, 11, 12, 13, 14, 15, 16, 17, 18, 19mm



15454 35,40€

1.10 10 300
Kg H mm

8"



15541 27,60€

0.95 10 220
Kg H mm

VAT not included

210x50x120mm

15514 9,35€



0.05 10 360
Kg it

15162 30,20€

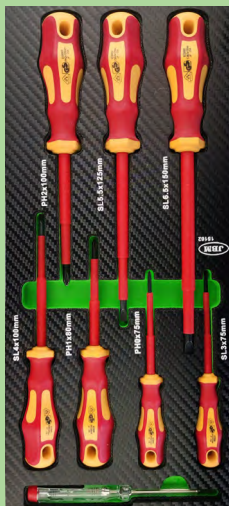

0.65 10 240
Kg it

Sizes:
SL 3x75mm PH 0x75mm 140 mm, slot
SL 4x100mm PH 1x80mm SL 0.5 x 3.0 mm
SL 5.5x125mm PH 2x100mm

15706 31,00€



0.55 - 10 240
Kg it

15737 45,00€



1.70 - 10 200
Kg it

15315 28,20€



1.05 - 10 260
Kg it

175x50x460mm

51864 64,00€

1.87 - 10 210
Kg it



10x11mm (290mmL),
12x14mm (330mmL),
13x15mm (368mmL),
16x18mm (407mmL),
17x19mm (407mmL),
22x24mm (430mmL)

52912 91,00€

1.62 - 10 210
Kg it

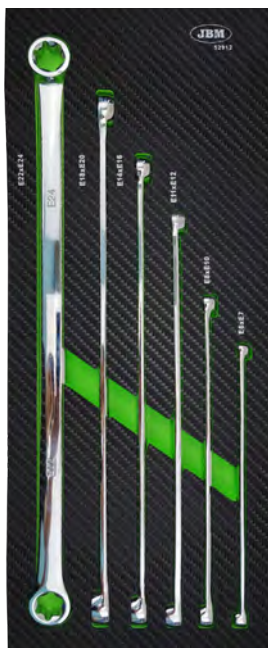

E6xE7 (200mmL),
E8xE10 (235mmL),
E11xE12 (290mmL),
E14xE16 (370mmL),
E18xE20 (410mmL),
E22xE24 (420mmL)

54066 83,00€

2.00 - 5 175
Kg it



8mm (23,5mmL)
10mm (29,3mmL)
12mm (32,8mmL)
13mm (34,9mmL)
14mm (36,7mmL)
17mm (41mmL)
19mm (42mmL)



520x50x390mm

15681 134,00€

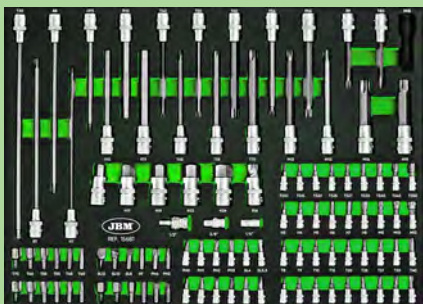

	H3, H4, H5, H6, H7, H8
	M8, M10, M12
	PH0, PH1, PH2, PH3
	PZ0, PZ1, PZ2, PZ3
	1/4" SL4, SL5.5, SL6.5, SL7
	T8, T9, T10, T15, T20, T25, T27, T30, T40
	T8, T9, T10, T15, T20, T25, T27, T30, T40
	TS10, TS15, TS20, TS25, TS27, TS30, TS40, TS45, TS50
	1/2" H7 (230mmL), H10, H11, H13 (140mmL), H14, H17, H19, H22, H24 (55mmL)
	M9 (100mmL), M10, M12, M14 (140mmL), M16 (53mmL), M16 (100mmL)
	R7, R8 (240mmL), R9 (100mmL), R10 (140mmL)
	T30 (300mmL), T40, T45, T50, T55, T60, T70 (140mmL), T80 (100mmL)
	HT5 (160mmL)

	1/2"	8mm
	3/8"	8mm
	1/4"	6mm
	1/2"	M18
		7, 8, 10, 12, 14mm
		PH3, PH4
		PZ3, PZ4
		SL8, SL10, SL12
	8mm	T40, T45, T50, T55, T60, T70
		T40, T45, T50, T55, T60, T70

15799 28,30€



1.35 - 10 200
Kg 5.8 11 15

16111 19,20€



0.61 - 10 360
Kg 5.8 11 15

11996 48,00€



2.10 - 10 300
Kg 5.8 11 15

6x7mm - 20x22mm +
24x27mm + 30x32mm

11997 39,00€



1.92 - 10 360
Kg 5.8 11 15

6x7mm - 18x19mm +
20x22mm

11998 49,00€



1.96 - 10 300
Kg 5.8 11 15

6x7mm - 18x19mm -
20x22mm



11994 33,00€

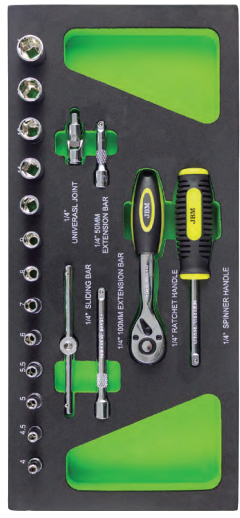

1/4"
0.68 - 10 233
Kg 5.8 11 15

14114 19,30€



0.93 - 10 360
Kg 5.8 11 15

13923 7,45€

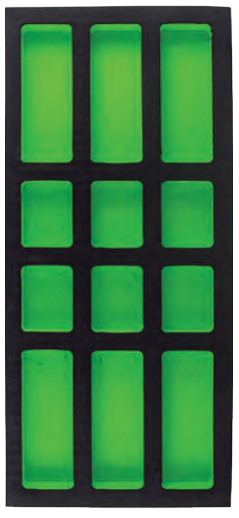

0.05 - 30 1299
Kg 5.8 11 15

13667 17,60€



0.83 - 10 360
Kg 5.8 11 15

13668 18,70€



0.61 - 10 300
Kg 5.8 11 15

PLASTIC TOOL SETS

10731 17,60€



0.68 - 10 233
Kg 5.8 11 15

10732 18,70€



0.70 - 10 220
Kg 5.8 11 15

10733 17,50€



0.69 - 10 220
Kg 5.8 11 15

10735 20,30€



0.98 - 10 300
Kg 5.8 11 15

53671 41,00€



210x50x120mm



1/4" - 85 mm
1/2" - 135 mm
3/8" - 102 mm

0.85 10 470
Kg 11 15



53620 88,00€

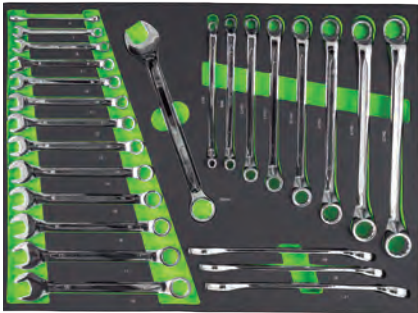

3.52 4 112
Kg

6x7,8x9,10x11,12x13,
14x15,16x17,18x19,20x22mm
6,7,8,9,10,11,12,13,
14,15,16,17,18,19,20,
21,22mm

54093 441,00€



3.52 4 112
Kg

51447 16,00€



0.34 5 20 960
Kg

50mm, 75mm, 100mm,
152mm, 227mm

53979 34,60€

340x50x390mm

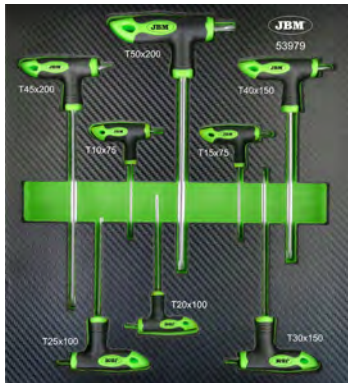

1.00 180
Kg

H2x100, H2.5x100, H3x100,
H4x150, H5x150, H6x200,
H8x200, H10x200

53980 34,60€

340x50x390mm



1.00 10 180
Kg

T10X75, T15X75, T20X100,
T25X100, T30X150,
T40X150, T45X200,
T50X200mm

51805 17,00€



0.33 4 20 640
Kg

50mm, 75mm, 100mm,
152mm, 227mm

51448 52,00€

130x50x540mm

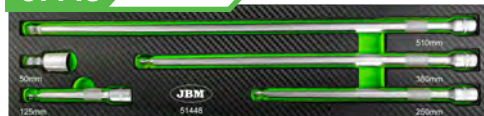

2.38 - 5 270
Kg

50mm, 125mm, 250mm, 380mm, 510mm

ACCESSORIES FOR TOOL TROLLEYS

COMPATIBILITY

53764 / 53765 / 53766 / 53767 / 53768 / 53769 / 53770 /
53900 / 53901 / 53902 / 53912 / 53913

SPRAY HOLDER

15313 14,00€

0.60 1 340
Kg



SPRAY HOLDER

14354 14,00€

0.60 1 184
Kg



PAPER ROLL HOLDER

15068 15,20€

0.65 25 500
Kg



FILE HOLDER

15069 32,80€

1.65 1 80
Kg



COMPATIBILITY

53686 / 53762 / 53661 53761 / 53767 / 53768 / 53904 / 54006

PAPER ROLL HOLDER

16161 17,50€

0.65 25 -
Kg



FILE HOLDER

16162 35,10€

1.65 1 -
Kg



SPRAY HOLDER

16163 10,20€

0.60 1 -
Kg



16188 39,60€

2.00 25 -
Kg



SPARE PARTS FOR CABINETS REF. 53661, 53686, 53763, 53764, 53765, 53766, 53866, 53867, 53868, 53869, 53870, 53900, 53901, 53904

REF.	DESCRIPTION	Kg	1	25	€	COMPATIBILITY
14578	Big ball bearing slide	1,05	1	25	12,50€	53661, 53686, 53904
14580	Top case	2,60	3	39	41,00€	53661, 53686, 53904
14783	Right side protector	0,25	1	50	5,50€	53661, 53686, 53904
15023	Swivel wheel	0,65	1	10	12,50€	53765, 53766, 53870
15024	Fixed wheel	0,95	1	8	15,00€	53765, 53766, 53870
15025	Swivel wheel	0,65	1	10	12,50€	53900, 53901
15026	Fixed wheel	0,95	1	8	15,00€	53900, 53901
15030	Swivel wheel	0,30	1	50	8,00€	53765, 53766
15033	Narrow drawer handle	0,30	1	50	6,00€	53868
15034	Top cover	-	-	-	57,00€	53868
15035	Drawer handle	0,36	1	20	8,50€	53869
15036	Drawer handle	0,36	1	20	8,50€	53870
15037	Drawer handle	-	-	-	8,00€	53900, 53901
15038	Top cover	-	-	-	34,50€	53869, 53870
15040	Fixed wheel	0,66	1	10	12,50€	53904
15041	Swivel wheel	0,98	1	8	15,00€	53904
15042	Drawer handle	0,10	1	-	7,50€	53904
15050	Drawer handle	0,10	1	50	9,50€	53661, 53686
15058	Side protector	-	-	-	7,50€	53868
15065	Side protector	0,55	1	12	6,50€	53869, 53870



14580, 15034,
15038



14783



15030, 15035,
15036, 15037,
15042, 15050



15033



14783

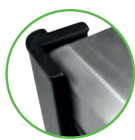

15058, 15065



15023, 15025,
15040



15024, 15026,
15041

3-LEVEL WORKSHOP TROLLEY

51576

125,00€

15.00	-	1	24
Kg	Sub	Box	Tray



LARGE 3-LEVEL WORKSHOP TROLLEY

52373

252,00€

150kg

24.70	-	1	12
Kg	Sub	Box	Tray

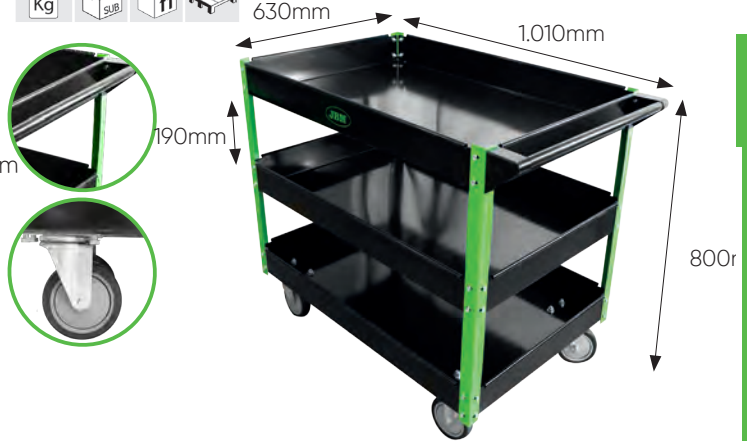

MULTIMEDIA WORKSTATION WITH WHEELS

51456

550,00€

42.50	-	1	2
Kg	Sub	Box	Tray

- Wheels without assemble.

4 WHEELS SET FOR CABINET REF. 51456

Ø12cm
2 wheels with breaks + 2 simples

11313

54,00€

4.11	-	1	104
Kg	Sub	Box	Tray



EXTERIOR

1165mm	675mm	458mm
--------	-------	-------

TOP DRAWER

70mm	570mm	425mm
------	-------	-------

LOWER DRAWER

890mm	670mm	455mm
-------	-------	-------

WALL PANEL

52419

80,00€

7.07	-	1	30
Kg	Sub	Box	Tray

1.000 x 600mm

52420

108,00€

10.80	-	2	35
Kg	Sub	Box	Tray

1.500 x 600mm

52421

172,00€

14.00	-	2	38
Kg	Sub	Box	Tray

2.000 x 600mm

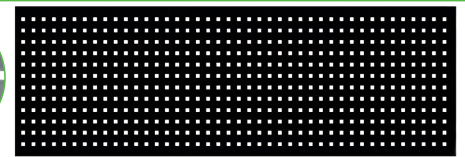

SQUARE HITCH

HOOKS

SPECIAL HOOK SCREWDRIVERS

51657

5,85€

FOR REF.:
52419, 52420, 52421

0.30	10	50	1000
Kg	Sub	Box	Tray

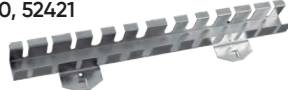

SPECIAL HOOK SPANNERS

51653

5,10€

FOR REF.:
52419, 52420, 52421

0.28	-	10	840
Kg	Sub	Box	Tray



FOR REF. 52419, 52420, 52421

95mm HOOK WITH CLOSED TIP
51654 4,80€

0.09	10	100	4000
Kg	Sub	Box	Tray

31mm HOOK WITH 2 SHORT TIPS
51655 4,10€

0.07	10	100	4000
Kg	Sub	Box	Tray

200mm HOOK WITH 2 EXTRA LONG TIPS
52634 5,25€

0.15	10	50	1500
Kg	Sub	Box	Tray

200mm EXTRA LONG HOOK CLOSED TIP
52635 4,80€

0.14	10	50	1500
Kg	Sub	Box	Tray

92mm LONG HOOK WITH 2 LARGE TIPS
51658 4,50€

0.05	10	100	1500
Kg	Sub	Box	Tray

91mm HOOK WITH 1 LARGE TIP
51656 3,65€

0.05	10	100	1500
Kg	Sub	Box	Tray

95mm 2 LARGE SPIKES
51422 2,97€

0.05	-	100	1500
Kg	Sub	Box	Tray

FOR REF. REF. 51035, 53661, 53686, 53761, 53762, 53767, 53768, 53904

2 LARGE SPIKES 95mm

FOR REF. 51428, 51430, 52705, 52706, 52707, 52708, 52709

1 LARGE SPIKE 90mm
51419 2,79€

0.03	-	100	2000
Kg	Sub	Box	Tray

1 SHORT SPIKE BOTTOM 30mm
51975 2,27€

0.03	-	100	4000
Kg	Sub	Box	Tray

2 LARGE SPIKES 75mm
51976 1,63€

0.03	-	100	3000
Kg	Sub	Box	Tray

51422 2,97€

0.05	-	100	1500
Kg	Sub	Box	Tray

WORKBENCH WITH BACK PANEL

51035

799,00€

INTERIOR DRAWER MEASURES

600Kg

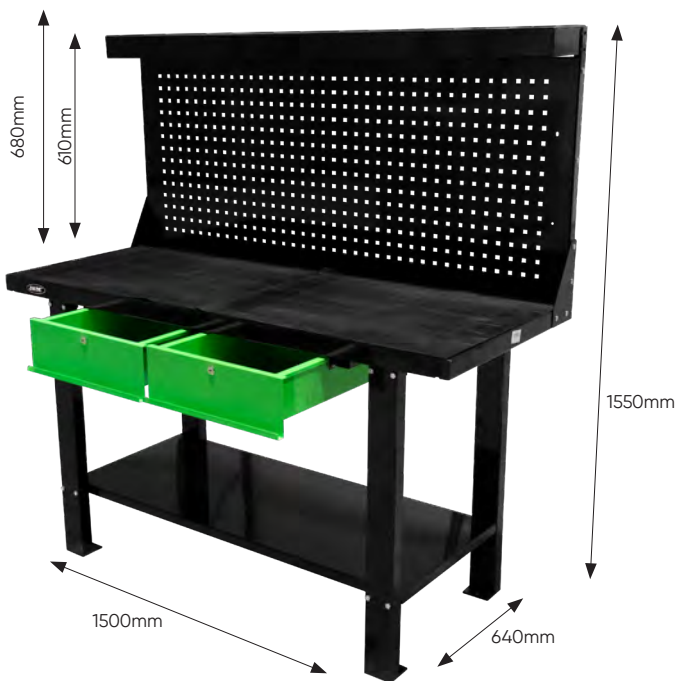
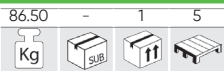

SET OF 2 RUBBER MATS FOR WORK TABLE REF. 51737

15145 20,45€



WORKBENCH WITH 3 DRAWERS

51738

850,00€

INTERIOR DRAWER MEASURES

1T

50Kg

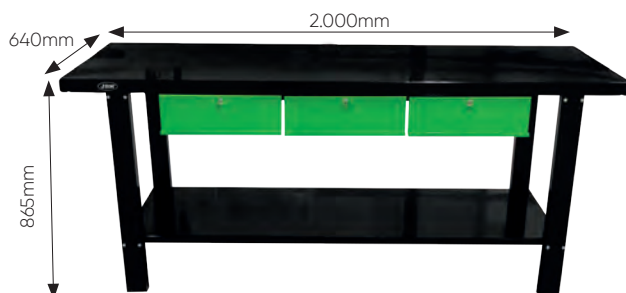
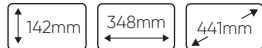

RUBBER MAT

15144 30,00€

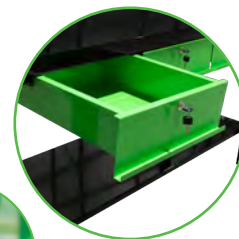

WORKBENCH WITH 2 DRAWERS

51737

699,00€

INTERIOR DRAWER MEASURES

800Kg

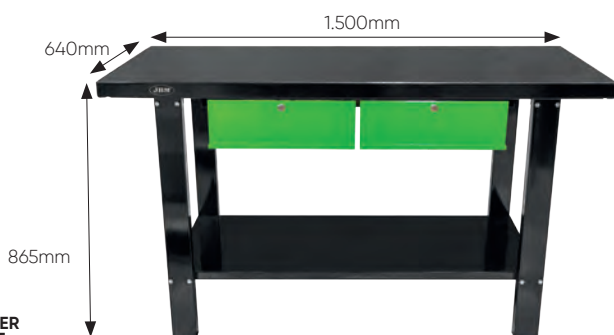
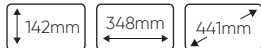
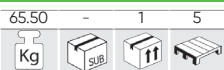

RUBBER MAT

15145 20,45€



WORKBENCH WITH 1 DRAWER

53674

447,00€

INTERIOR DRAWER MEASURES

800Kg

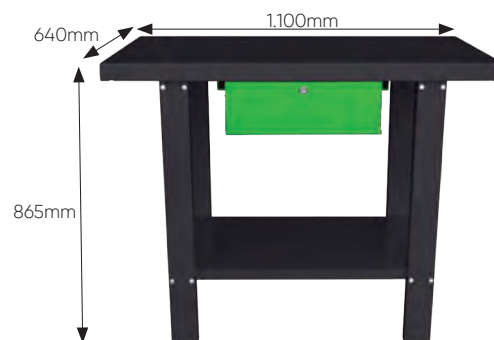
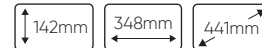
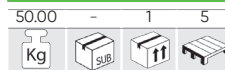

RUBBER MAT

15146 16,20€



MODULAR TOOL BOX TROLLEY

53672

440,00€

23,00	-	1	6

90
PCS



3 DETACHABLE AND SEPARABLE COMPARTMENT

THEY CAN BE USED INDIVIDUALLY OR TOGETHER



TOP HANDLE ON EACH MODULE TO EASY INDIVIDUAL TRANSPORTATION



LOCKABLE WITH PADLOCK (NOT INCLUDED)

3 INDEPENDENT MODULES EQUIPPED WITH:



	1/2" x11	8,10,11,12,13,14,16,17,19,21,22mm
	1/4" x13	4,4.5,5.5,5.6,7.8,9,10,11,2,13,14mm
	1/2" x2	125,300mm
	1/4" x2	50,100mm

	1/4" x1	
	1/4" x1	
	1/4" x1	
	1/2" x1	
	1/4" x1	
	x8	1,5x8mm
	x1	3m
	1/4" x32	



	x1	180mm
	x1	160mm
	x2	160mm, 180mm
	x2	PH2x125, PH1x100mm
	x2	6x150mm, 5x100mm



	x9	8,9,10,11,12,13,14,17,19mm
	x1	250mm
	x1	300g
	x1	250mm
	x1	200mm



Removable upper tray

Container for bigger tools

1 TOOL BOX IN EVA MODULES + REMOVABLE UPPER TRAY



2 2 DRAWERS WITH TOOLS IN EVA MODULES

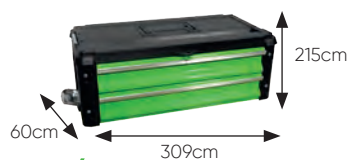

3 FOLDING HANDLE



VAT not included

JBM / www.jbmcamp.com



64 PIECES CANTILEVER TOOL BOX SET

53565 258,00€



CrV 64 PCS



SATIN FINISH



CONTAIN

	1/2" x18	10, 11, 12, 13, 14, 15, 16, 17, 18, 19, 20, 21, 22, 23, 24, 27, 30, 32mm		1/2" x1	255mm		+	x3	PH1x100mm, PH2x150mm, PH3x200mm
	7Z x1	1/2"		x1	457mm		-	x3	SL5x100mm, SL6x150mm, SL8x200mm
	x1	1/2"		x18	6, 7, 8, 9, 10, 11, 12, 13, 14, 15, 16, 17, 18, 19, 20, 21, 22, 24mm			x1	250mm
	1/2" x3	76, 127, 254mm		x9	15, 2, 2.5, 3, 4, 5, 6, 8, 10mm			x1	200mm
								x1	180mm



5 TRAY CANTILEVER TOOL BOX

51574 52,00€

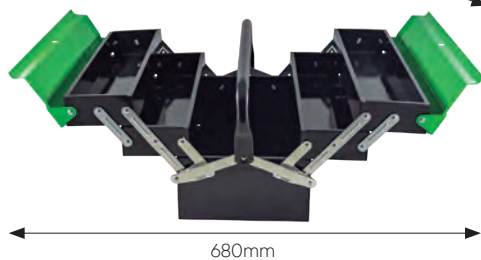

XL CANTILEVER TOOL BOX

53222 57,00€



XL

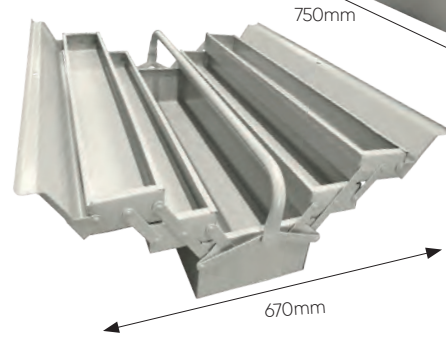
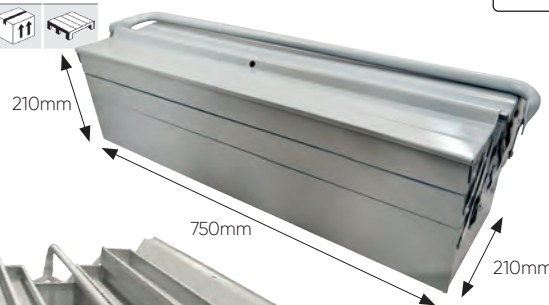

3 DRAWER TOOL CHEST BOX WITH SUPERIOR COMPARTMENT

51600 109,00€



INTERIOR DRAWER MEASURES

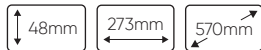

WITH HANDLE



6 DRAWER TOOL CHEST + SUPERIOR COMPARTMENT

51575 317,00€



- Big drawers: 570mm weight
- Small drawers: 180mm weight

WITHOUT HANDLE

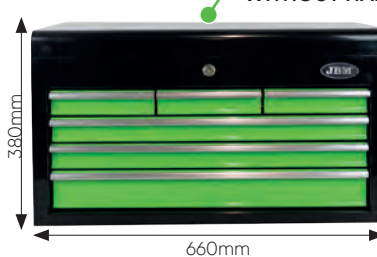

ADJUSTABLE WORK SEAT

50843 79,00€

5,61 - 1 48
Kg SUB

135KG

Ø 295mm

Ø 380mm

520mm

520mm / 390mm

WORK STOOL

50844 65,00€

3,50 - 1 60
Kg SUB

100KG

360mm

380mm

375mm

MECHANIC'S CREEPER

52148 82,00€

6,00 - 1 20
Kg SUB

150KG

- Reinforced rubber wheels.
- High density plastic.
- High resistance.

480mm

1.020mm

120mm

WHEEL FOR REF. 52148

11971 3,10€

0,20 50 -
Kg SUB

MECHANIC'S CAR CREEPER AND SEAT

50808 77,00€

5,63 - 1 28
Kg SUB

150KG

440mm

930mm

105mm

MECHANIC'S CAR CREEPER AND SEAT

53211 75,00€

5,40 - 1 38
Kg SUB

150KG

900mm

420mm

125mm

350mm

420mm

450mm

52542 109,00€

12,70 - 1 19
Kg SUB

135KG

420mm

1.180mm

105mm

650mm

450mm

475mm

115KG

STEEL AND PVC

6 WHEELS

QUICK RELEASE 150MM VICE

52871 248,00€

24,50 - 1 28

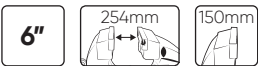

FAST OPENING
BY LEVER +
ROTATING BENCH VISE

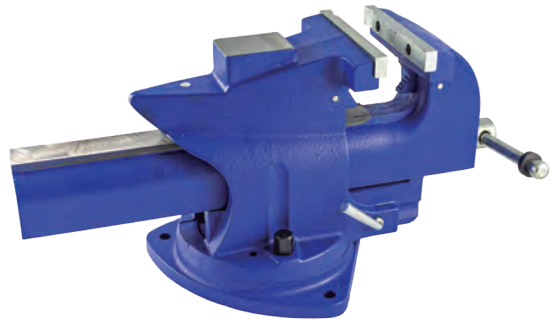

SWIVEL BASE VICE

53031 59,00€

5,70 - 1 128

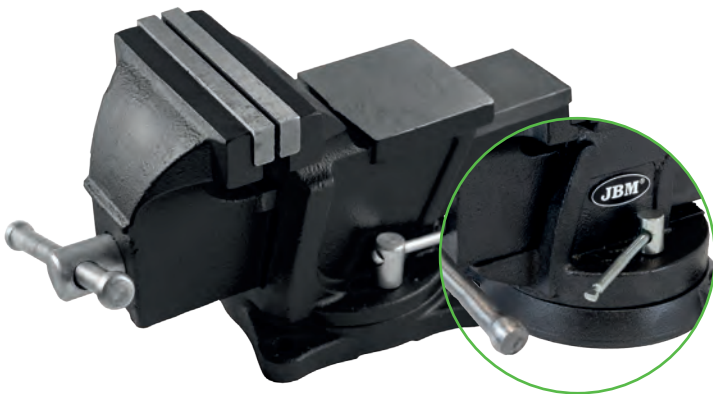
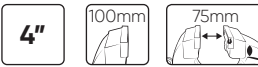

53032 126,00€

13,71 - 1 60

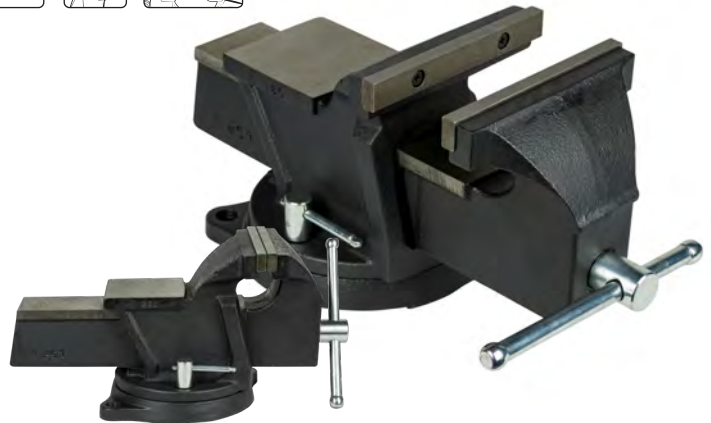

WORKSHOP VICE

52869 52,00€

4,15 - 4 192



52870 100,00€

12,15 - 1 72

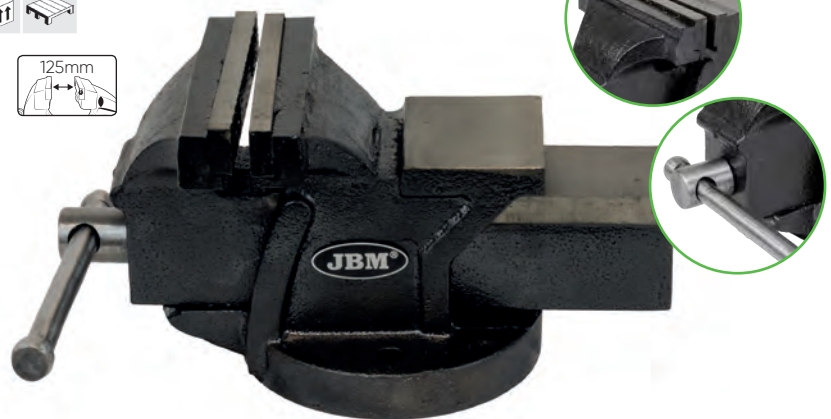
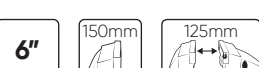

STEEL ANVIL

52308 440,00€

47,00 - 1 24



52309 941,00€

100,00 - 1 8

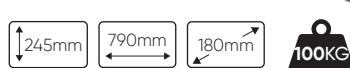

STEEL



POWER TOOLS CORDLESS

- 88 IMPACT WRENCH
- 91 SCREWDRIVER / RATCHET
- 92 IMPACT DRILL / BRUSHLESS ANGLE GRINDER
- 94 ORBITAL SANDER / POLISHER
- 95 SAWS
- 98 OSCILLATING MULTI TOOL
- 99 GUNS
- 101 VACUUM CLEANER / COMPRESSOR
- 102 LED WORK LIGHT
- 103 GARDENING POWER TOOLS
- 107 STORAGE
- 108 BATTERIES / CHARGERS
- 109 ACCESSORIES

Cordless power tools, for more comfortable and unlimited use

With **BRUSHLESS** engine: greater efficiency, longer life, more speed and less noise.



BRUSHLESS IMPACT WRENCH 1/2"

1000Nm

60018 306,00€



Battery not included.

This tool is designed to **tighten and loose screws**.



20V **1000 Nm** **1/2"** **0-2300IPM**

BRUSHLESS MOTOR

① 0-900 RPM ② 0-1600 RPM ③ 0-1900 RPM

LED

OUTPUT SHAFT 14675 17,00€	SWITCH 14677 9,00€	HEAD SHELL 14679 9,50€	CIRCUIT BOARD + STATOR 14648 106,00€
IMPACT BLOCK ASSEMBLY 14676 36,50€	CIRCUIT BOARD 14678 86,00€	ROTOR 14769 37,75€	

5 DIFFERENT GEARS



Want to see how it works?



- Parts:
- Ergonomic handle.
- Forward/Reverse selector.
- Trigger switch.
- LED work light.
- Belt hook.



BRUSHLESS IMPACT WRENCH 1/2"

1200Nm

60044 478,00€

3.20 - 5 144



Battery not included.

This tool is designed to **tighten and loose screws**.



BRUSHLESS MOTOR

20V **1200 Nm** **1/2"**

① 0-1000 RPM ② 0-1350 RPM ③ 0-1600 RPM

0-1000IPM 0-1600IPM 0-2000IPM

YUNQUE

16151 50,00€

FRONT HOUSING

16152 25,10€

IMPACT BLOCK

16153 81,00€

ROTOR

16154 34,10€

STATOR

16155 34,10€

SWITCH

16156 12,60€

PRINTED CIRCUIT BOARD

16157 59,00€

5 DIFFERENT GEARS



1/2" BRUSHLESS IMPACT WRENCH WITH STORAGE CASE

60044C 652,00€

3.20 - 5 4

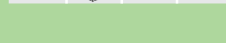

20V CHARGER - 4A

60016 49,00€

0.80 - 5 210

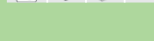

4,0 Ah LI-ION BATTERY

60013 80,00€

0.75 - 5 700



Use them with JBM batteries: a single battery suitable for all tools

LI-ION BATTERIES

2.0Ah



60012

4.0Ah



60013



60015

CHARGERS



4A
60016



FAST CHARGER 6A
60017



IMPACT



BRUSHLESS IMPACT WRENCH 3/4"

1550Nm

60034 320,00€

3,20	-	4	144

Battery not included.

This tool is designed to **tighten and loose screws**.

BRUSHLESS MOTOR

20V **1550 Nm** **3/4"**

① 0-900 RPM ② 0-1600 RPM ③ 0-1900 RPM

OUTPUT SHAFT

14675 17,00€

SWITCH

14677 9,00€

HEAD SHELL

14679 9,50€

IMPACT BLOCK ASSEMBLY

14676 36,50€

CIRCUIT BOARD

14678 86,00€

ROTOR

14769 37,75€

CIRCUIT BOARD + STATOR

14648 106,00€

5 DIFFERENT GEARS



Want to see how it works?



- Parts:
- Ergonomic handle.
- Forward/Reverse selector.
- Trigger switch.
- LED work light.
- Belt hook.



BRUSHLESS SCREWDRIVER

60005 132,00€

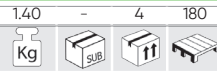

Battery not included.

Brushless impact driver ref. 60005 designed to drive in screws and tighten nuts quickly, especially when working with long fasteners and tough materials.

It is equipped with a LED working light to improve accuracy while working, a 1/4" hex quick change toolless chuck type for a fast bit's insertion and removal, and a trigger switch which can be locked to prevent an accidental starting of the tool.

- It includes:
- Built-in led work light.
- Chuck type: 1/4" hex quick change.
- Variable speed switch.
- Soft grip handle.
- Metal gear box.
- Belt hook.



BRUSHLESS MOTOR 20V 200 Nm LED 0-2800 RPM 1/4"



IMPACT BLOCK **14637** 15,50€

CIRCUIT BOARD **14642** 83,00€

T-AXIS **14638** 7,00€

CIRCUIT BOARD + STATOR **14765** 97,00€

SWITCH **14640** 8,00€

HEAD SHELL **15254** 12,50€

ROTOR **14641** 18,50€

CONSUMABLES

53857



53858



page 111

Use them with JBM batteries: a single battery suitable for all tools

LI-ION BATTERIES

2.0Ah



60012

4.0Ah



60013



60015

CHARGERS



4A

60016



FAST CHARGER

6A

60017

1/2" BRUSHLESS RATCHET

60024 190,00€

THIS REFERENCE IT INCLUDES X1 BATTERY Y X1 CHARGER



This tool is designed to tighten and loose screws in reduced spaces.



BRUSHLESS MOTOR 12V 80 Nm 1/2" 0-175 RPM LED 2.0AH 60min +/- 10min

CE RoHS

IT INCLUDES:

12V CHARGER FOR REF. 60026

60025 31,60€



2.0 Ah LI-ION SAMSUNG BATTERY FOR REF. 60024

60026 37,90€



VAT not included

JBM / www.jbmcamp.com

2-SPEED IMPACT DRILL

60006 182,00€

2.50	-	4	68
Kg	SUB	↑	↑

Battery not included.

This tool is designed to carry out **drilling tasks in wood and metal**, drilling **impact tasks**, more common in **masonry, in concrete, stone and red brick**, as well as to **tighten, loosen or remove screws and nuts**.

It features a functional conversion ring which allows to set the tool to the **drill mode, impact drill mode and screw mode**, an adjustment ring that allows to choose among **23 different torque settings, a speed selector**, and a **1/2" keyless chuck** for a fast and convenient bit's insertion and removal.



- It includes:
Built-in led work light.
2-speed switch.
Soft grip handle.
Auxiliary handle.
Belt hook.

DRILL CHUCK

14643 24,50€

SWITCH

14644 8,00€

ROTOR

14645 45,00€

CIRCUIT BOARD + STATOR

14646 110,00€

AUXILIARY HANDLE

14954 14,50€

BRUSHLESS MOTOR

20V 80 Nm

1/2" 29750IPM

① 0-500 RPM ② 0-1750 RPM

LED

CHUCK SIZE:
2-13MM (1/2")



AUXILIARY HANDLE



CONSUMABLES

page 109-111

MASONRY DRILL BIT SET

53861



3-10MM

8 PCS

53860



4-10MM

5 PCS



STEEL
YG8

HSS 4341 TWIST DRILL SET

53852



1-10MM

170 PCS

53856



1-13MM

25 PCS

IMPACT BITS WITH QUICK ADAPTOR SET S2 BLACK FINISH

53857



49 PCS

53858



21 PCS

BI-METAL HOLE SAW SET

53859



8 PCS

HSS M42
4-6TPI

BRUSHLESS ANGLE GRINDER

Diam. of the wheel: **115mm (4-1/2")**

Diam. of the wheel: **125mm**

60008 141,00€

1.85	-	4	156
Kg	SUB	↑	↑

60028 142,00€

1.95	-	4	144
Kg	SUB	↑	↑

- This angle grinder is designed to carry out all kind of **grinding, sanding and cutting tasks**.
- Thread size: **M14**.

Battery not included.
Disc not included.

BRUSHLESS MOTOR

20V 8000 RPM

M14

- It includes:
1pc wheel guard.
1pc side handle.
1pc spanner.

ROTOR

14652 47,00€

SWITCH

14653 5,25€

CIRCUIT BOARD + STATOR

14654 104,00€

GEAR #13

14655 5,95€

PRESSING PLATE

14656 4,50€

BEARING #23

14657 4,50€

GEAR #22

14766 3,15€

BEARING #29

14767 2,34€

AUXILIARY HANDLE

14956 4,40€

115MM WHEEL GUARD

14957 4,10€

125MM WHEEL GUARD

14808 3,05€

M14 QUICK CHANGE FAST LOCKING NUT

15014 20,00€



CONSUMABLES

page 112

CUTTING DISC FOR METAL/STAINLESS STEEL

14893

T42



14900

T41



M14 ANGLE GRINDER QUICK CHANGE FAST LOCKING NUT

15014



BRUSHLESS ROTARY HAMMER

60023 212,00€

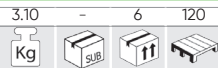

Battery not included.

This tool is designed to perform impact drilling and chiseling tasks in concrete and brick, as well as tasks in other materials such as steel, wood, metal, ceramic and plastic where normal drilling is required.

- Chuck type: **SDS**.



BRUSHLESS MOTOR

20V 4750BPM 2.2 J 1350 RPM

WOOD 28mm **CONCRETE** 22mm **STEEL** 13mm

SDS

- It includes:
 1pc dust cover.
 1pc depth gauge.
 1pc auxiliary handle.
 1pc point chisel.
 1pc flat chisel.
 SDS drill bits: 8/10/12 x 150mm.



IMPULSE LEVER	SEALING RING	DUST COVER
14693 3,50€	14698 1,00€	14967 5,50€
PENDULUM ROD BEARING	ROTOR	DEPTH GAUGE
14694 11,50€	14699 30,00€	14968 6,00€
IMPACT HAMMER	BEARING #61	
14695 4,00€	14700 2,50€	
AIR CYLINDER	CIRCUIT BOARD	
14696 18,00€	14702 92,00€	
SWITCH	BEARING #67	
14697 8,00€	14701 2,50€	

CONSUMABLES

page 109

14837 SDS-PLUS CHISEL POINT 14X250MM	14839 SDS-PLUS FLAT CHISEL 40X250MM	14841 SDS PLUS DRILL CHUCK ADAPTOR 1/2"	14842 2-13MM 1/2"-20UNF KEYLESS DRILL CHUCK	53850 SDS PLUS HAMMER DRILL BIT SET
14838 SDS-PLUS FLAT CHISEL 20X250MM	14840 SDS-PLUS GROOVE CHISEL 250MM			

BRUSHLESS ORBITAL SANDER

60033 104,00€



Battery not included.

This tool is designed for **sanding wood, iron, plastic and similar materials** using suitable sandpaper. This sander is adjustable to three different speeds, has a comfortable grip and has a built-in dust collection bag.



20V 6000 RPM 8000 RPM 10000 RPM

0°C 45°C

x3 SPEED 150mm

DUST COLLECTION BAG	BEARING	BEARING
15530 7,50€	15533 4,50€	15536 14,50€
VACUUM BAG SUPPORT	BEARING	BRAKE RUBBER BLOCK
15531 5,00€	15534 4,50€	15537 6,00€
STATOR +PCB + SWITCH	BEARING SEAT	BASE PLATE
15532 98,00€	15535 3,50€	15538 17,00€

Use them with JBM batteries: a single battery suitable for all tools

LI-ION BATTERIES



CHARGERS





BRUSHLESS POLISHER

60009 168,00€

2.65	-	4	80
Kg	sub	ff	

Battery not included.



This tool has been designed for finishing processes such as **polishing and rounding off corners and edges**, as well as for achieving **smooth surfaces** by means of its wheel and polishing pad. The rotational speed of the wheel can be adjusted to **9 different selection stages** with the regulation dial, and **trigger switch can be locked on** for use or locked off for storage to prevent an accidental starting of the tool.

- It includes:
- 1pcs auxiliary D handle.
- 1pcs hex wrench.
- 1pcs polisher pad.
- 9 stage speed selection: 800, 1000, 1200, 1400, 1600, 1800, 2000, 2200, 2400.
- Soft grip handle.
- Trigger switch lock-off button.
- Spindle lock button.

BRUSHLESS MOTOR

20V

800-2400 RPM

M14

Ø 180mm

AJUSTABLE SPEED

ROTOR

14658 45,00€

CIRCUIT BOARD + STATOR

14660 83,00€

BEARING #24

14662 2,50€

POLISHING PAD

14958 22,00€

SWITCH

14659 5,00€

GEAR

14661 9,00€

BEARING #26

14663 2,50€

AUXILIARY D HANDLE

14959 10,00€



BRUSHLESS PLANER

60020 175,00€

3.15	-	4	72
Kg	sub	ff	

Battery not included.

This tool is designed to perform woodworking tasks. It can be used to achieve a smooth finish in wood surfaces chamfering corners or marking rabbets.

This tool has an **aluminum alloy base** to provide accuracy while planing, a **dust collection system** to capture the woodworking dust, and a **trigger switch lock-off button** to prevent an accidental starting of the tool



- It includes:
- 1pc rabbeting depth adjusting knob.
- 1pc parallel guide.
- 3pcs locking knob.
- 1 pc wrench.
- 1pc screw.



BRUSHLESS MOTOR

20V

16000 RPM

10,5mm

82mm

0-2mm

- Features:
- Cutting depth adjusting knob.
- Aluminum alloy base.
- Trigger switch lock-off button.
- Dust collection system.
- Soft grip handle.

STATOR

14936 27,50€

BELT

14684 3,00€

RABBETING DEPTH GUIDE

14964 8,00€

SWITCH

14685 5,00€

PARALLEL GUIDE

14965 8,50€

CIRCUIT BOARD

14686 73,00€

ROTOR

14687 35,00€





RECIPROCATING SAW

60019 178,00€

3.45 - 4 112

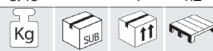

Battery not included.

This tool is designed to perform **cutting tasks in a wide variety of materials and can be used for multiple applications.** Its design allows a **fast and convenient blade change by means of its toolless collet sleeve**, as well as a variable cutting speed to better adapt to the operation to be performed.



- It includes:
1pc: Wood blade.
1pc: Metal blade.

BRUSHLESS MOTOR

28mm 3000 SPM

WOOD Max: 150mm
STEEL Max: 10mm

20V

RECIPROCATING LEVER

14680 17,00€

CIRCUIT BOARD + STATOR

14681 108,00€

SWITCH

14682 9,00€

CIRCUIT BOARD

14683 86,00€

ROTOR

14770 40,00€

CONSUMABLES FOR REF 60019

page 112

14995



14994



CONSUMABLES FOR REF 60010

page 112

14993



14991



BRUSHLESS JIG SAW

60010 170,00€

2.80 - 4 144



Battery not included.

This tool has been designed to carry out **cutting tasks in different materials** such as **wood, steel, plastic and metal.** It features **4 pendulum action positions:** 3 orbital cutting actions and 1 straight cutting action, which allows to adapt the blade cutting speed according to the material hardness.



20V

WOOD
Max: 135mm

STEEL
Max: 8mm

26mm

2600 SPM

LED

CIRCUIT BOARD + STATOR

14664 100,00€

SWITCH

14665 8,80€

CIRCUIT BOARD

14666 97,00€

GEAR

14667 8,80€

RECIPROCATING LEVER

14668 7,70€

ROLLER COMPONENTS

14670 4,50€

ROTOR

14768 28,80€

DUST TUBE

14960 3,85€

PARALLEL GUIDE

14961 3,95€

- It includes:
1pc: Wood blade.
1pc: Edge guide.
1pc: Dust pipe.

- Features:
Metal gear box.
Soft grip handle.
Variable speed switch.
4-position pendulum action.
Aluminium base.
Built-in LED work light.
Trigger switch lock-off button.



Use them with JBM batteries: a single battery suitable for all tools

LI-ION BATTERIES

2.0Ah



60012

4.0Ah



60013



60015

CHARGERS



4A
60016



FAST CHARGER
6A
60017

MINI CIRCULAR SAW

60011 175,00€

2.55 - 4 128



Battery not included.

This tool has been designed to perform **wood cutting tasks**. The **saw of blade of 115mm in diameter and 24 teeth** makes it ideal for carry out **straight longitudinal and transverse cuts** in wood panels and panels, as well as **angle cuts of up to 45°**. This circular saw also features a **trigger lock-off button** to prevent an accidental starting of the tool, and an **aluminum guard**.



- It includes:
1pc: 115mm 24T TCT blade.
1pc: Edge guide.
1pc: Dust pipe.
1pc: Hex key.

- Features:
Lock-off switch.
Soft grip handle.
Aluminum upper and lower guard.
Dust collection system.

BRUSHLESS MOTOR

20V **AL** **4000 RPM**

90° : 42.8mm | 45° : 28mm | Ø 115mm 10mm

ROTOR	CIRCUIT BOARD + STATOR	PARALLEL GUIDE
14671 44,00€	14674 73,00€	14963 7,50€
SWITCH	DUST TUBE	
14672 5,00€	14962 6,50€	



CONSUMABLES FOR REF 60011

page 112

Circular saw blade 24T 115mm

14989 14986

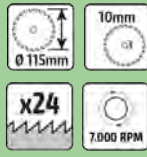

CONSUMABLES FOR REF 60007

page 112

Circular saw blade 24T 165mm

14988 14985

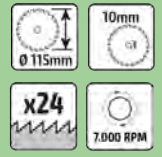

CIRCULAR SAW

60007 170,00€

Battery not included.

3.75 - 4 60



This tool has been designed to perform **wood cutting tasks**. The saw of blade of **165mm in diameter and 24 teeth** makes it ideal for carry out **straight longitudinal and transverse cuts** in wood panels and panels, as well as **angle cuts of up to 45°**.



BRUSHLESS MOTOR

20V **AL** **4300 RPM**

90° : 55mm | 45° : 36mm | Ø 165mm (6-1/2") 20mm **LED**

- Features:
Lock-off switch.
Soft grip handle.
Aluminum upper and lower guard.
Built-in LED work light.

SWITCH	GEAR	PARALLEL GUIDE
14647 3,00€	14650 5,00€	14955 7,50€
ROTOR	CIRCUIT BOARD + STATOR	
14649 50,00€	14651 86,00€	

- It includes:
1pc: 165mm 24T TCT blade.
1pc: Edge guide.
1pc: Hex key.





SLIDE MITRE SAW

60022 470,00€



Battery not included.

This tool is designed to perform **cutting tasks in wood and wood-like materials**. It can be used to make **bevel cuts**, where an inclined cut over the workpiece surface is required, **miter cuts**, commonly used for joints that form an angle of 90°, as well as **compound cuts**, where a simultaneous angle cut on the edge and front surface of the workpiece is required.

It comes equipped with a **dust extraction bag**, a **laser guide**, a **spanner** for the blade's insertion and removal, and a **clamping vice** for the workpiece. Moreover, it has a **safety button** to activate the trigger switch and prevent an accidental starting of the tool.

BRUSHLESS MOTOR 20V 30A LASER 3500 RPM

	90°	90°	45°	45°
	: 50mm	: 50mm	: 50mm	: 50mm
	205mm	152mm	205mm	152mm
	90°	45°	45°	45°
	: 38mm	: 38mm	: 38mm	: 38mm
	205mm	152mm	205mm	152mm

Ø185mm 25.4mm

MOTOR

14691 167,00€

SWITCH

14692 5,50€

DUST EXTRACTION BAG

14966 7,50€



- It includes:
1pcs clamp.
1pcs blade wrench.
1pcs dust extraction bag.



CONSUMABLES FOR REF 60022

page 112

Scie circulaire 40T 185mm

14990

14987



- Material: YG8 tips, tungsten carbide body.



Use them with JBM batteries: a single battery suitable for all tools

LI-ION BATTERIES

2.0Ah



60012

4.0Ah



60013



60015

CHARGERS



4A
60016



FAST CHARGER
6A
60017

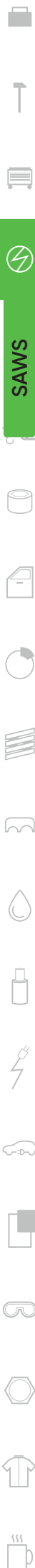

BRUSHLESS OSCILLATING MULTI TOOL UNIT

60041 77,00€

1.60 - 4 216



Battery not included.

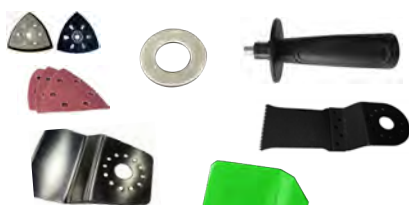

LOCKING LEVER

15320 1,00€

BALL BEARING 625

15321 3,00€

SPEED CONTROLLER

15324 18,00€

CIRCUIT BOARD

15325 3,50€

MIDDLE COVER

15322 3,50€

MOTOR

15323 24,00€

GASKET

15326 1,00€

AUXILIARY HANDLE

15327 5,50€

The oscillating electric multitool allows you to put different types of accessories so you can carry out a variety of tasks. It is especially useful for scraping, sanding and plunge cutting in narrow spaces.



20V
BRUSHLESS MOTOR



VARIOUS

CONSUMABLES

page 111

53999

54000

54002

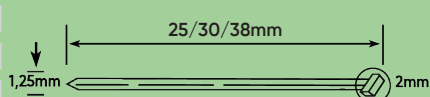

54008

54010

54011

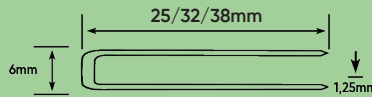

NAIL GUN

60037 222,00€

3.60 - 4 128



Battery not included.

This tool is designed for **tacking** of cardboard, insulating material, fabric, foils, leather and similar materials **on surfaces of wood or wood-like materials** by means of its high-power compressed air driven impact firing.

It comes equipped with a LED light to indicate the status of the power tool, a LED light for an enhanced visibility during operation, a drive shift knob to select between the single and contact firing mode for a more precise or quick firing, and a depth adjustment wheel

to set the nail/staple heads firing depth as desired. It also features a belt hook and soft grip handle.

Besides, it comes equipped with a **safety contact pin**, which needs to be pressed against the workpiece before the trigger switch is squeezed to fire nails/staples under the single firing mode, thus, working as a security mechanism to avoid an accidental starting of the tool.

20V 2000Ah

MAX 100 grapas por minuto
staples per minute

60 grapas por minuto
staples per minute

Capacidad máxima del cargador
Max. magazine capacity
100
Clavos grapas
Nails staples



Max. length of nails	50 mm
	18 Gauge Brad Nails
Max. nail cross section width	1.25 mm
Max. nail cross section thickness	1.05 mm

Max. length of staples	40 mm
	18 Gauge narrow crown light duty staples
Max. staple cross section width	1.2 mm
Max. staple cross section thickness	1 mm
Max. staples crown	6 mm

FIRING PIN ASSEMBLY

15276 46,00€

SEALING COVER ASSEMBLY

15277 9,00€

SAFETY FRAME

15278 3,50€

MOTOR

15279 69,00€

COMMUTATOR

15280 91,00€

Use them with JBM batteries: a single battery suitable for all tools

LI-ION BATTERIES

2.0Ah



60012

4.0Ah



60013



60015

CHARGERS



4A
60016



FAST CHARGER
6A
60017

CORDLESS GREASE GUN

60038 255,00€

Battery not included.

3,90	-	4	32

This tool has been designed for **lubricating purposes** and can be easily transported and manipulated wherever thanks to its cordless design.

It is equipped with a led work light for an enhanced visibility in the working area, a safety purge valve to avoid excessive pressure and clogging, a soft ergonomic handle for a better control and a trigger switch lock-off button to avoid an accidental starting of the tool. Besides, the grease output flow rate can be adjusted to **8 different gears** by means of the speed adjustment wheel.



20V **9000PSI 620BAR**

Volumen / caudal
volume / flow rate **200g/min**

Capacidad de grasa en cartucho hasta
Grease cartridge capacity up to **420g**

Capacidad de grasa a granel
Bulk grease capacity **600g**

Tipo de grasa hasta
Grease type up to **NLGI #2**

8 Niveles de caudal
Flow level

760mm



PUMP	CIRCUIT BOARD	MICROTRIGGER	FLEXIBLE HOSE
15380 169,00€	15382 42,00€	15381 5,50€	15440 33,00€

BATTERY CAULKING GUN

60032 123,00€

Battery not included.

1,95	-	4	80

This tool is designed to **seal up any gap or crack in a wide variety of materials** such as metal, glass, wood and ceramic. It comes equipped with a **LED work light** for an enhanced visibility, specially while operating in dark places, a **variable speed** switch and a **trigger lock-off system**. It also features an **anti-drip mechanism**. After releasing the switch 0.2-0.3s, the back-gluing time is of 0.8s.



20V **2500 Nm**

300ml **0,5-8mm/s**

LED

AJUSTABLE SPEED

MECANISMO ANTIGOTEO ANTI-DROP MECHANISM

MOTOR	CIRCUIT BOARD
15126 19,50€	15127 29,00€



Use them with JBM batteries: a single battery suitable for all tools

LI-ION BATTERIES

2.0Ah **60012** **4.0Ah** **60013** **60015**

CHARGERS

4A **60016** **FAST CHARGER 6A** **60017**

HEAT GUN

60042 106,00€

1.00 - 4 240



Battery not included.

This cordless hot gun mainly usage purpose is: **shrink PVC, soldering, curling plastic spare part and ordinary drying, melting and unfreezing.**



MOTOR

15719 11,00€

HEATING ELEMENT

15720 59,00€

PRINTED CIRCUIT BOARD

15721 46,00€

20V

15A

550°C
1022°F

Max.
200L/min.

0.6kg

Ø 34mm

PA6-GF30+TPE



CORDLESS PAINT SPRAYER

60043 123,00€

1.70 - 3 90



This tool is designed for spraying paint on indoor and outdoor surfaces.

Battery not included.

SPRAY NOZZLE

15722 4,25€

VALVE

15723 2,21€

SEAL WASHER

15724 2,82€

O-RING

15725 1,86€

SEAL WASHER

15726 2,82€

PAINT TANK

16150 7,90€

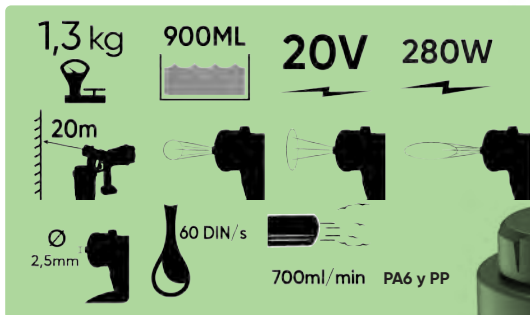

The sprayer can be adjusted with three different spraying modes: round, horizontal and vertical.



Use them with JBM batteries: a single battery suitable for all tools

LI-ION BATTERIES

2.0Ah



60012

4.0Ah



60013



60015

CHARGERS



4A
60016



FAST CHARGER
6A
60017



- It includes:
1 Crevice nozzle.
1 Extension tube.
1 Brush nozzle.
1 Floor nozzle.



HANDHELD VACUUM CLEANER

60001 88,00€

1.70	-	4	64
Kg	sub	ff	

Battery not included.

This **cordless** electric vacuum cleaner has been designed to vacuum any material which is not harmful to one's health.

The **rechargeable battery** makes it be **easily portable**, and the different accessories allows you to carry different types of cleaning in several places and spots.

20V



3,8 kPa 500mL

FILTER ELEMENT	EXTENSION TUBE	FLOOR NOZZLE
14628 2,50€	14950 6,50€	14952 19,00€
SWITCH	CREVICE NOOZLE	BRUSH NOZZLE
14629 4,00€	14951 9,50€	14953 8,50€
MOTOR	FILTER WITH HOUSING FOR PORTABLE VACUUM CLEANER	
14630 22,00€	15765 14,00€	

ELECTRIC AIR COMPRESSOR PUMP

60003 110,00€

Battery not included.

1.85	-	4	100
Kg	sub	ff	

This inflator allows you to inflate car and bike tires, balls, rafts, air mattresses, swimming pool floats, etc.

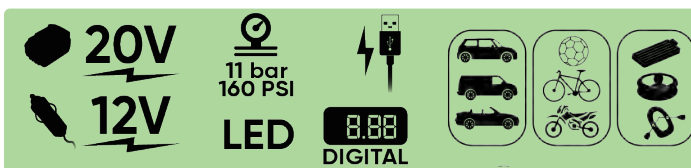

- It includes:



PUMP ASSEMBLY	WORKING MODE SWITCH	HIGH PRESSURE HOSE
14634 36,50€	14631 3,50€	15151 10,50€
BLOWER	LED LIGHT SWITCH	
14635 10,00€	14632 3,50€	



High pressure hose length: 760 mm
High capacity hose length: 460 mm



Use them with JBM batteries: a single battery suitable for all tools

LI-ION BATTERIES



CHARGERS



BRUSHLESS ELECTRIC PRESSURE WASHER GUN

60039 265,00€

3.30	-	2	36
Kg	SUB	↑	↑

Battery not included.

The brushless electric pressure washer is designed to clean the workplace, home, tools and equipment, decks, boats, outdoor furniture and vehicles.

BRUSHLESS MOTOR 319-507 PSI 22-25 BAR

20V 2.0-2.4L/min **2.0 kg**

It includes a regulable nozzle which allows you choose the suitable stream of water depending on the dirty and the surface you are cleaning



SCREW CAP FOR THE INLET WATER VALVE
15481 4,50€

CONNECTOR OF THE INLET WATER PIPE
15484 5,50€

SET OF 6 UNIDIRECTIONAL VALVES
15487 59,00€

NON-RETURN VALVE NEEDLE FOR INLET AND OUTLET PIPE
15490 4,00€

TOP RING OF THE SPRING FOR THE INLET WATER VALVE
15482 4,00€

HERMETIC RING FOR SWITCH
15485 4,00€

HERMETIC RING FOR INLET AND OUTLET PIPE
15488 4,00€

SPRING OF THE PRESSURE RELIEF VALVE
15491 4,00€

SPRING OF THE INLET WATER VALVE
15483 4,00€

SWITCH FOR WASHER GUN
15486 9,00€

INLET AND OUTLET PIPE
15489 10,50€

ELBOW PIPE
15492 5,00€

SPRING
15493 4,50€



BACKPACK SPRAYER 15L

60027 99,00€

5.65	-	1	15
Kg	SUB	↑	↑

Battery not included.
Compatible with REF 60012 - 60013

Suitable for **environmental disinfection** of houses, public spaces, livestock farms, gardens, etc., contributing to the **eradication of all infectious particles and its spread**, as well as the **prevention of pests and diseases**.
Diaphragm pump **smart handle switch** which can be locked on for a continuous operation.
Equipped with **4 different nozzles** to adapt the spraying flow and power according to the spraying need required: 1 hollow cone nozzle, 1 dual hollow cone nozzle, 1 4-hole adjustable nozzle, 1 fan nozzle.

20V **15L** 0.3-0.45 Mpa

1-1.2m 40 - 80cm



Extensible telescopic spraying lance.

Refill cap with anti-release design

Handle for easy carrying

Support to place the lance



BREATHABLE AND ERGONOMIC back pad to avoid the feeling of heaviness after a long period of use and facilitate the perspiration and dissipation of sweat.



- It includes:



Use them with JBM batteries: a single battery suitable for all tools

LI-ION BATTERIES

2.0Ah



60012

4.0Ah



60013



60015

CHARGERS



4A 60016



FAST CHARGER 6A 60017

BRUSHLESS ELECTRIC CHAINSAW

60029 240,00€

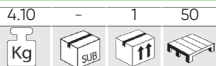

Battery not included.

This tool for forest service has been **designed to perform wood-cutting tasks** such as tree felling, limbing, bucking and cutting. It is equipped with a knob to adjust the guide bar and chain tension, a chain brake to stop the chain if you get a kickback, and a chain catcher to catch it if it snaps or jumps off. Besides, it features an automatic **system for chain lubrication** and a **trigger switch lock-off button** to avoid an accidental starting of the tool. It also includes bar guide, a chain and a **cover to protect** both the bar and chain for storage and transportation.

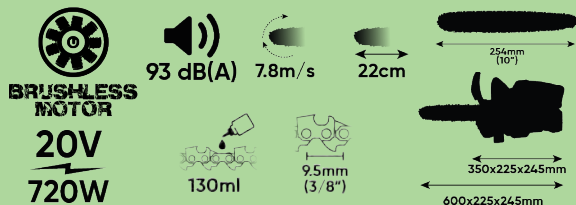

SIGNALLING SWITCH

15098 11,50€

OIL PUMP

15101 11,00€

SAW CHAIN

15104 31,50€

TRIGGER SWITCH

15099 5,50€

ROTOR ASSEMBLY

15102 40,00€

GUIDE BAR

15105 30,00€

CIRCUIT BOARD

15100 70,00€

STATOR

15103 20,50€

AUXILIARY D HANDLE

15106 15,00€

SET OF FILES FOR CHAINSAW

54128 10,50€



ELECTRIC HEDGE TRIMMER

60031 142,00€

3.45 - 1 24



Battery not included.

This tool is designed to perform **gardening tasks** such as trimming, cutting or pruning hedges or bushes **in a fast and convenient way**. Powered with a lithium-ion battery, it is ideal to transport from one place to another thanks to its cordless design and light weight.

It comes equipped with a **blade cover** to help keep the trimmer in good conditions, a **guard** that helps to deflect chips or other debris **away from the operator's hands and eyes**, and an **auxiliary handle** for a better control and comfort. Besides, it features two switches and a **lock-off button** to prevent an accidental start-up of the tool.

20V
230W



<93dB(A)

1490RPM

475mm

<2.5m/s²



18mm

45°

920x215x192mm



REAR TRIGGER SWITCH

15114 6,00€

CUTTING BLADE ASSEMBLY

15118 52,00€

MICRO SWITCH #8

15115 8,50€

MICRO SWITCH #31

15119 10,00€

CIRCUIT BOARD

15116 29,50€

FRONT TRIGGER SWITCH

15120 6,50€

MOTOR

15117 29,50€

AUXILIARY D HANDLE

15121 12,00€

Use them with JBM batteries: a single battery suitable for all tools

LI-ION BATTERIES

2.0Ah



60012

4.0Ah



60013



60015

CHARGERS



4A
60016



FAST CHARGER
6A
60017

ELECTRIC 4-IN-1 GARDEN MULTI FUNCTION TOOL

60040 440,00€

Battery not included.

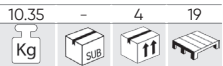

The electric multi-function 4 in 1 garden machine is designed for a multiple of outdoor tasks, such as clearing green spaces, trimming garden hedges, cutting branches, etc. It is an ideal product for all-round garden maintenance.

- It includes:



- It comes with a pole saw, a hedge trimmer and a brush cutter with a thread head and a three-tooth blade.

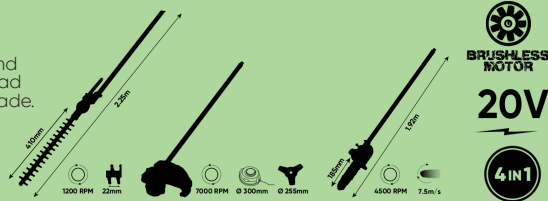

BEARING	15462	7,50€	STRING FOR BRUSH CUTTER	15474	8,50€
GEAR	15465	11,50€	THREE-TOOTH BLADE FOR BRUSH CUTTER	15475	8,50€
KEY	15468	2,50€	PROTECTIVE COVER FOR BRUSH CUTTER	15476	11,00€
GUIDE FOR POLE SAW	15471	20,10€	BEARING	15464	6,50€
CHAIN FOR POLE SAW	15472	19,00€	GEAR	15467	14,00€
GRASS HEAD	15473	13,70€	BEARING	15470	7,50€
ROTOR	15463	114,00€	PROTECTIVE COVER BASE FOR BRUSH CUTTER	15477	5,70€
BEARING	15466	6,50€	BLADE FOR BRUSH CUTTER	15478	3,60€
OUTPUT SHAFT	15469	9,50€			



ELECTRIC BLOWER

60030 112,00€

Battery not included.

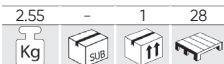

This tool is designed to **blow-sweeping leaves, grass, paper and similar materials**. Powered with a lithium-ion battery, it is ideal to transport from one place to another thanks to its cordless design and light weight.

It features a switch for a **high or low air flow speed and volume** configuration and a **soft grip handle** for a better control and grip.

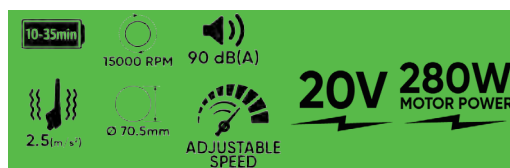

MICRO SWITCH	15107	4,00€	CIRCUIT BOARD	15109	25,50€	MOTOR	15111	30,40€	BLOW PIPE	15113	11,80€
TRIGGER SWITCH	15108	2,16€	COMMUTATOR	15110	6,55€	INLET DIVERSION CONE	15112	3,25€			

Use them with JBM batteries: a single battery suitable for all tools

LI-ION BATTERIES



CHARGERS



ROBOTIC LAWN MOWER

52598 1.080,00€

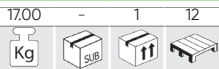

- Autonomous lawn mower robot.
- Cordless and easy to store.



5200 mAh Capacidad de la batería Battery capacity	1400m² Superficie de corte Mowing area	2,5H 	2H 	22m/min
115,44W Consumo de energía Power consumption	AC 100-240V 50 / 60Hz Tensión de entrada Input Voltage	DC 15-25,5V Tensión de salida Output Voltage	IP X4	70 dB

Cutting height:
2,5 - 5,5cm

Cutting width: 18cm

Charging station

Blade rotate speed:
3500rpm

STAPLES FOR BOUNDARY WIRE 150PCS
15425 50,00€

REAR WHEEL AND MOTOR
15434 147,00€

CUTTING BLADE & SCREWS 3 PCS
15426 10,00€

CUTTING PLATE AND PROTECTION PLATE
15435 24,50€

FRONT WHEELS
15439 52,00€

CUTTING MOTOR
15436 97,00€

NAILS FOR DOCKING STATION 4 PCS
15427 9,00€

MOTHER BOARD
15437 305,50€

BATTERY 22.2V, 600mAh
15428 238,00€

BOUNDARY WIRE SENSOR
15438 31,00€

CHARGING STATION
15431 241,00€

EXTENSION CORD 5M
15429 23,50€

BOUNDARY WIRE CONNECTOR
15432 18,50€

ADAPTER
15430 83,00€

GARAGE FOR LAWN MOWER
15433 197,00€

BOUNDARY WIRE 150M
15424 105,00€



APP CONNECTION

CORDLESS LAWN MOWER

60045 298,00€



40V

BRUSHLESS MOTOR

800W



370x45mm

3300 RPM

4000 mAh
Capacidad de la batería
Battery capacity

IP X1

35L

96 dB(A)

Cutting height:
6 (25-75mm)



CABLE
16138 7,45€

FAN BLADE HOLDER
16141 4,45€

PCB - #68-4 (REF.60045)
16145 79,00€

GRASS BOX - #6 (REF.60045)
16139 14,20€

370MM BLADE - #20 (REF.60045)
16142 10,80€

MICRO SWITCH - #68-10 (REF.60045)
16146 4,45€

SECURITY KEY FOR REF.60045 #61
16160 3,99€

STATOR ASSEMBLY - #32-13 (REF.60045)
16149 38,60€

BLADE SCREW - #21 (REF.60045)
16143 2,06€

BIG GEAR - #32-5 (REF.60045)
16147 13,00€

BACK WHEEL - #13 / (REF.60045)
16140 14,20€

FRONT WHEEL - #23 (REF.60045)
16144 12,80€

ROTOR ASSEMBLY - #32-11 (REF.60045)
16148 35,40€



TRAY

14622 17,00€

0,95 - 10 360



FOR REF. 60001, 60003, 60004, 60020

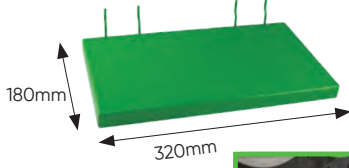

14624 17,00€

0,65 - 10 300



FOR REF. 60007, 60010, 60011

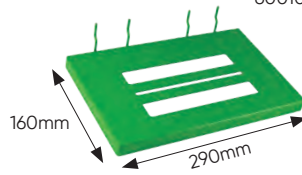

HANGER

14625 14,00€

0,50 - 10 700



FOR REF. 60008, 60009

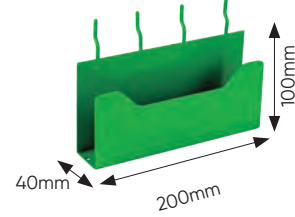

HOOK

14623 8,00€

0,10 - 10 800

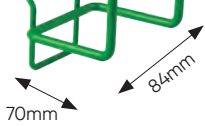

FOR REF. 60005, 60006, 60018

14626 7,00€

0,10 - 10 -

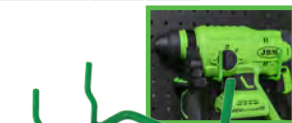

FOR REF. 60023

TOOL BAG

53702 28,50€

1,00 - 5 180



SMALL



53703 41,00€

1,40 - 5 120



MEDIUM



53704 42,00€

1,65 - 5 120



LARGE



OPEN MOUTH TOOL BAG - LARGE

53782 14,00€

0,65 - 20 160



25Kg/13L



INTERNAL DIVIDER

REAR AND SIDE POCKETS

TOOL BACKPACK

53258 67,00€

2,60 - 2 32



15Kg

1.165mm 575mm 230mm

- Tools not included.

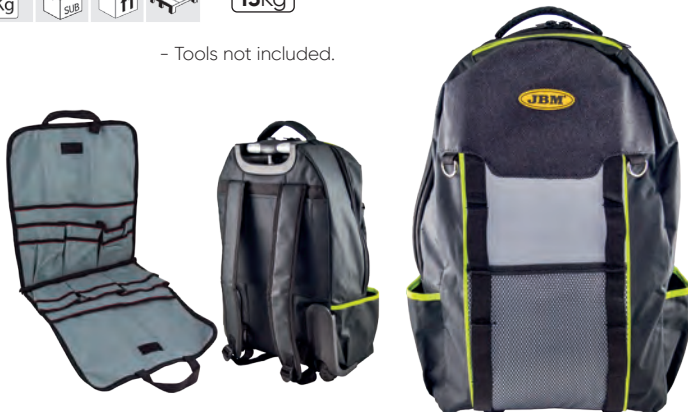

ROLLING TOOL BAG WITH TUBULAR HANDLE

53253 98,00€

4,50 - 2 12



20Kg/18L

- 600D Polyester.
- Tools not included.

420mm 360mm 250mm



Use them with JBM batteries: a single battery suitable for all tools

Three types of battery and two types of charger.
Choose the one you prefer!

* Batteries and chargers
NOT INCLUDED
in the tools.



LI-ION BATTERIES



POWER INDICATOR



SHORT CIRCUIT
PROTECTION



OVER HEATING
PROTECTION



OVER CHARGING
PROTECTION

20V

12V

2.0Ah



4.0Ah



6.0Ah



2.0Ah



60012 48,00€

0.45	-	30	920
Kg	Sub	ft	in

60013 80,00€

0.75	-	5	700
Kg	Sub	ft	in

60015 138,00€

1.00	-	20	600
Kg	Sub	ft	in

FOR REF. 60024

60026 37,90€

0.20	8	5	1400
Kg	Sub	ft	in

CHARGERS

50-60Hz



100V

240V



POWER INDICATOR



OVER HEATING
PROTECTION



OVER CHARGING
PROTECTION

20V



SHORT CIRCUIT
PROTECTION

12V



4A

60016 49,00€

0.80	-	5	210
Kg	Sub	ft	in



**FAST
CHARGER**

60017 64,00€

0.80	-	5	290
Kg	Sub	ft	in



12V CHARGER
FOR REF. 60026

60025 31,60€

0.30	5	4	700
Kg	Sub	ft	in

2.0AH 30min +/-10min 4.0AH 60min +/-15min

6.0AH 90min +/-15min

2.0AH 30min +/-10min 4.0AH 45min +/-10min

6.0AH 60min +/-15min

2.0AH 60min +/-10min

SDS-PLUS CHISELS

- Material: 40Cr steel, sand blasted.



STEEL 40CR



60023

FOR MASONRY

POINT - 14x250mm

14837 3,30€

0.30	5	4	700
Kg	Sub	Box	Tray

STRAIGHT CHISEL - 20x250mm

14838 3,40€

0.25	10	100	-
Kg	Sub	Box	Tray

GROOVE - 250mm

14840 3,35€

0.27	10	50	-
Kg	Sub	Box	Tray

FLAT - 40x250mm

14839 4,70€

0.29	10	50	-
Kg	Sub	Box	Tray



7 PIECES SDS PLUS HAMMER DRILL BIT SET

53850 14,90€

0.65	5	25	1000
Kg	Sub	Box	Tray



STEEL YG8

7 PCS

60023

5x110, 6x110, 6x160, 8x110, 8x160, 10x160, 12x160mm



FOR MASONRY



- Single flute, flat tip, sand blasted.
- Material: YG8 alloy steel tips, carbon steel body.



SPARE PARTS AVAILABLE

REF.	mm	Kg	Sub	Box	Tray	€
14826	Ø 5x110mm	0,05	125	500		1,50€
14828	Ø 6x110mm	0,05	25	500		1,50€
14830	Ø 8x110mm	0,04	25	500		1,50€
14829	Ø 6x160mm	0,04	25	500		1,50€
14831	Ø 8x160mm	0,05	25	500		1,50€
14832	Ø 10x160mm	0,05	25	200		2,00€
14920	Ø 12x160mm	0,10	100	200		2,50€

YOU MAY ALSO LIKE...

REF.	mm	Kg	Sub	Box	Tray	€
14825	Ø 4x110mm	0,05	100	200		1,50€
14827	Ø 5x160mm	0,04	25	500		2,00€
14833	Ø 10x210mm	0,10	20	200		2,05€
14834	Ø 12x210mm	0,10	100	200		2,50€
14835	Ø 14x210mm	0,10	20	125		3,00€
14836	Ø 16x210mm	0,14	20	120		3,50€

ADAPTER SDS PLUS TO DRILL CHUCK ADAPTOR 1/2"

14841 2,58€

0.05	50	250	-
Kg	Sub	Box	Tray

60023



FOR MASONRY

STEEL 40CR

- Material: 40Cr steel, sand blasted.
- Length: 7,5cm.
- Diameter: 1cm.
- Weight: 45g.



2-13MM 1/2"-20UNF KEYLESS DRILL CHUCK

14842 9,50€

0.26	5	50	-
Kg	Sub	Box	Tray

60023

- Material: Steel
- Length: 6cm
- Diameter: 4cm

- Type: keyless
- Clamping range: 2-13mm
- Thread mount: 1/2"-20UNF



MASONRY DRILL BIT SET

- Material: YG8 alloy steel tips, carbon steel body.

3-10MM

53861 5,45€

0.20	5	50	950
Kg	Sub	Box	Tray

3x60, 4x75, 5x80, 6x100, 7x100, 8x120, 9x120, 10x120mm

4-10MM

53860 3,65€

0.15	5	50	950
Kg	Sub	Box	Tray

4x75, 5x80, 6x100, 8x120, 10x120mm

8 PCS

5 PCS

STEEL YG8



FOR MASONRY

60006

SPARE PARTS AVAILABLE

REF.	mm	Kg	Sub	Box	Tray	€
14907	Ø 3x60mm	0,01	50	100		0,50€
14908	Ø 4x75mm	0,01	50	100		0,60€
14909	Ø 5x80mm	0,01	50	100		0,80€
14910	Ø 6x100mm	0,01	50	100		1,00€
14911	Ø 7x100mm	0,01	50	100		1,30€
14912	Ø 8x120mm	0,05	50	100		1,55€
14913	Ø 9x120mm	0,05	50	100		1,90€
14914	Ø 10x120mm	0,04	20	100		2,10€

YOU MAY ALSO LIKE...

REF.	mm	Kg	Sub	Box	Tray	€
14915	Ø 11x150mm	0,05	20	100		2,65€
14916	Ø 12x150mm	0,06	20	100		2,95€
14917	Ø 13x150mm	0,10	20	100		3,45€



METRIC HSS 4341 TWIST DRILL SET

- Material: HSS 4341.

1-10MM

53852 207,00€

4,20 - 4 192



170
PCS

1x34, 1.5x40, 2x49, 2.5x57, 3x61, 3.5x70, 4x75, 4.5x80, 5x86, 5.5x93, 6x93, 6.5x101, 7x109, 7.5x109, 8x117, 8.5x117, 9x125, 9.5x125, 10x133mm

- It includes 170 drills:
1.0 - 8.0mm x 10pcs (each 0.5mm).
8.5 - 10mm x 5pcs (each 0.5mm).

1-13MM

53856 62,00€

1,32 5 10 550



25
PCS

1x34, 1.5x40, 2x49, 2.5x57, 3x61, 3.5x70, 4x75, 4.5x80, 5x86, 5.5x93, 6x93, 6.5x101, 7x109, 7.5x109, 8x117, 8.5x117, 9x125, 9.5x125, 10x133, 10.5x133, 11x142, 11.5x142, 12x151, 12.5x151, 13x151mm

1-10MM

53854 27,00€

0,63 5 20 192



19
PCS

1x34, 1.5x40, 2x49, 2.5x57, 3x61, 3.5x70, 4x75, 4.5x80, 5x86, 5.5x93, 6x93, 6.5x101, 7x109, 7.5x109, 8x117, 8.5x117, 9x125, 9.5x125, 10x133mm



60006

HSS-G
4341



FOR METALS



SPARE PARTS AVAILABLE

REF.	mm	Kg	Sub	QTY	€
14868	∅ 1x34mm	0,01	50	400	0,55€
14869	∅ 1.5x40mm	0,01	50	400	0,60€
14870	∅ 2x49mm	0,01	50	400	1,00€
14871	∅ 2.5x57mm	0,01	50	400	1,00€
14872	∅ 3x61mm	0,01	50	400	1,00€
14873	∅ 3.5x70mm	0,01	50	400	1,00€
14874	∅ 4x75mm	0,01	50	400	1,00€
14875	∅ 4.5x80mm	0,01	50	400	1,50€
14876	∅ 5x86mm	0,01	50	300	1,50€
14877	∅ 5.5x93mm	0,02	50	300	1,50€
14878	∅ 6x93mm	0,02	25	400	2,00€
14879	∅ 6.5x101mm	0,02	25	400	2,00€
14880	∅ 7x109mm	0,03	25	400	2,50€
14881	∅ 7.5x109mm	0,03	25	400	2,50€
14882	∅ 8x117mm	0,04	25	400	3,00€
14883	∅ 8.5x117mm	0,04	25	400	3,50€
14884	∅ 9x125mm	0,05	25	400	3,65€
14885	∅ 9.5x125mm	0,05	25	400	4,00€
14886	∅ 10x133mm	0,06	25	400	4,60€
14887	∅ 10.5x133mm	0,07	25	400	5,00€
14888	∅ 11x142mm	0,08	25	400	6,00€
14889	∅ 11.5x142mm	0,09	25	400	6,50€
14890	∅ 12x151mm	0,10	25	300	7,00€
14891	∅ 12.5x151mm	0,09	25	200	7,50€
14892	∅ 13x151mm	0,09	25	200	8,00€

HSS 4241 TWIST DRILL SET BLACK

- Material: HSS 4241 BLACK.

1-10MM

53851 88,00€

3,80 - 4 192



170
PCS

1x34, 1.5x40, 2x49, 2.5x57, 3x61, 3.5x70, 4x75, 4.5x80, 5x86, 5.5x93, 6x93, 6.5x101, 7x109, 7.5x109, 8x117, 8.5x117, 9x125, 9.5x125, 10x133mm

- It includes 170 drills:
1.0 - 8.0mm x 10pcs (each 0.5mm).
8.5 - 10mm x 5pcs (each 0.5mm).

1-13MM

53855 24,80€

1,19 5 10 192



25
PCS

1x34, 1.5x40, 2x49, 2.5x57, 3x61, 3.5x70, 4x75, 4.5x80, 5x86, 5.5x93, 6x93, 6.5x101, 7x109, 7.5x109, 8x117, 8.5x117, 9x125, 9.5x125, 10x133, 10.5x133, 11x142, 11.5x142, 12x151, 12.5x151, 13x151mm

1-10MM

53853 14,40€

0,58 5 20 192



19
PCS

1x34, 1.5x40, 2x49, 2.5x57, 3x61, 3.5x70, 4x75, 4.5x80, 5x86, 5.5x93, 6x93, 6.5x101, 7x109, 7.5x109, 8x117, 8.5x117, 9x125, 9.5x125, 10x133mm



60006

HSS-R
4241



FOR METALS



SPARE PARTS AVAILABLE

REF.	mm	Kg	Sub	QTY	€
14843	∅ 1x34mm	0,01	50	400	0,50€
14844	∅ 1.5x40mm	0,01	50	400	0,50€
14845	∅ 2x49mm	0,01	50	400	0,50€
14846	∅ 2.5x57mm	0,01	50	400	0,50€
14847	∅ 3x61mm	0,01	50	400	0,50€
14848	∅ 3.5x70mm	0,01	50	400	0,50€
14849	∅ 4x75mm	0,01	50	400	1,00€
14850	∅ 4.5x80mm	0,01	50	400	1,00€
14851	∅ 5x86mm	0,01	50	300	1,00€
14852	∅ 5.5x93mm	0,02	50	300	1,00€
14853	∅ 6x93mm	0,02	25	400	1,00€
14854	∅ 6.5x101mm	0,02	25	400	1,00€
14855	∅ 7x109mm	0,03	25	400	1,00€
14856	∅ 7.5x109mm	0,03	25	400	1,00€
14857	∅ 8x117mm	0,03	25	400	1,50€
14858	∅ 8.5x117mm	0,04	25	400	1,50€
14859	∅ 9x125mm	0,04	25	400	1,50€
14860	∅ 9.5x125mm	0,05	25	400	2,00€
14861	∅ 10x133mm	0,06	25	400	2,00€
14862	∅ 10.5x133mm	0,07	25	400	2,00€
14863	∅ 11x142mm	0,07	25	400	2,50€
14864	∅ 11.5x142mm	0,07	25	400	2,50€
14865	∅ 12x151mm	0,08	25	300	2,50€
14866	∅ 12.5x151mm	0,09	25	200	3,00€
14867	∅ 13x151mm	0,09	25	200	3,00€

QUICK CHANGE DRILL BIT ADAPTOR SET BLACK FINISH

53857 27,00€

0,40	6	24	1152

- Material: S2 steel, black oxide with rim, DIN standard.

- It includes:

49pcs 25mm impact bits:
PH1x3, PH2x3, PH3x3
PZ1x3, PZ2x3, PZ3x3
SL4x2, SL5x2, SL6x2
H: 3,4,5
T: 10x2, 15x2, 20x2, 25x2, 27x2, 30x2, 40x2
T TAMPER:10,15,20,25,27,30,40
7pcs 65mm impact bits with rim: PH2, PH3, PZ1, PZ2, T20, T25, SL6.
1pc 60mm stainless steel quick release chuck adaptor.

60005/60006

STEEL S2 49 PCS



DRILL BIT ADAPTER SET S2 BLACK FINISH

53858 28,80€

0,55	6	24	672

- Material: S2 steel, black oxide with rim.

- It includes:

21pcs 25mm impact bits:
PH:1,2,2,3
PZ:1,2,3
H:3,4,5,6
SL:3,4,5,6
T:10,15,20, 25, 30, 40
6pcs impact bits 75MM: T15, T20, T25, PH2, PZ2, SL5
1pc 80mm extension bar
1pc 60mm quick release chuck adaptor
4pcs 48mm nut drivers: 6,7,8,10mm

60005/60006

STEEL S2 33 PCS



IN 6 UNITS
DISPLAY CASE



IN 6 UNITS
DISPLAY CASE

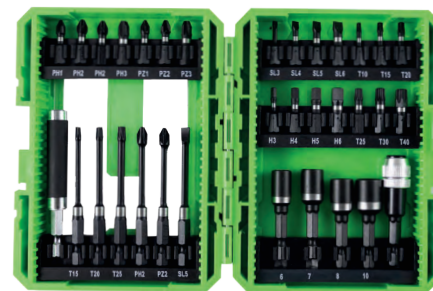

18 GA BRAD NAIL SET

				€
53999	25x1.25mm	0,20	50	2,00€
54000	30x1.25mm	0,24	50	2,50€
54002	38x1.25mm	0,29	50	3,00€

60037

1000
PCS

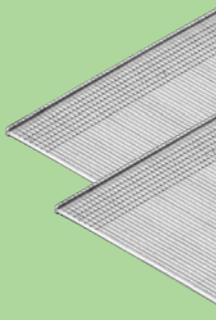
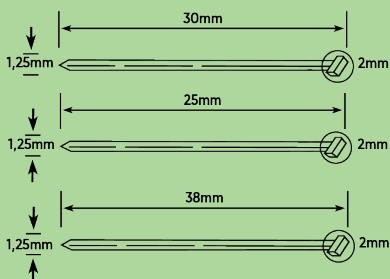

18 GA NARROW CROWN STAPLE SET

				€
54008	25x6mm	0,43	40	3,50€
54010	32x6mm	0,47	40	4,50€
54011	38x6mm	0,63	40	5,00€

60037

1000
PCS

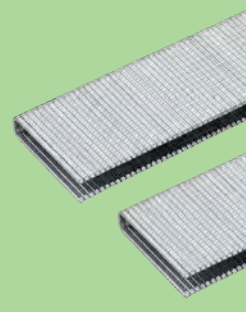
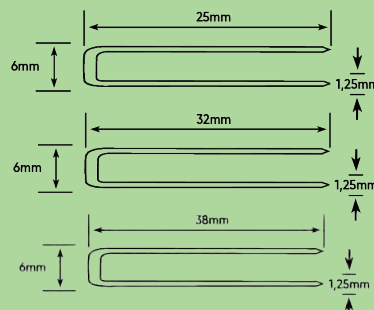

BI-METAL HOLE SAW SET WITH ADAPTERS

53859 67,00€

1,35	5	10	140

- To cut metal and stainless.
- Hole saw material:
Teeth: Bimetal HSS M42, 4-6TPI.
Body: Carbon Steel.
- Arbor material: Bimetal HSS.

CONTAINS

	x6	22, 29, 35, 44, 51, 68mm
	x2	14-30mm, 32-152mm



60006

HSS M42
4-6TPI 8
PCS



FOR METALS AND
STAINLESS STEEL

SPARE PARTS AVAILABLE

REF.	mm				€
14901	Saw 22mm	0,04	10	50	3,60€
14902	Saw 29mm	0,08	10	50	4,65€
14903	Saw 35mm	0,10	10	50	5,25€
14904	Saw 44mm	0,12	10	50	6,85€
14905	Saw 51mm	0,12	10	50	8,50€
14906	Saw 68mm	0,19	10	50	10,20€
14934	Arbor 14-30mm	0,07	10	50	4,25€
14935	Arbor 32-152mm	0,2	10	50	8,45€

VAT not included

JBM / www.jbmcamp.com

111

SAW BLADES

FOR METAL (STAINLESS STEEL, ALUMINUM, COOPER)

FOR	REF.	DESCRIPTION	Kg	Box	Box	€
60011	14989	Circular saw blade 24T 115mm	0,08	-	20 100	6,00€
60007	14988	Circular saw blade 24T 165mm	0,19	-	20 40	8,00€
60022	14990	Circular saw blade 40T 185mm	0,26	-	20 40	10,50€
60019	14995	Recip saw blades 150mm 24TPI	0,01	2	20 200	8,00€
60010	14993	Jig saw blades T118A	0,01	5	20 200	5,00€

FOR WOOD

FOR	REF.	DESCRIPTION	Kg	Box	Box	€
60011	14986	Circular saw blade 24T 115mm	0,07	-	20 100	4,00€
60007	14985	Circular saw blade 24T 165mm	0,18	-	20 40	6,00€
60022	14987	Circular saw blade 40T 185mm	0,24	-	20 40	8,50€
60019	14994	Recip saw blades 150mm 6TPI	0,01	2	20 200	3,50€
60010	14991	Jig saw blades T244D	0,01	5	20 200	2,00

14989 14986

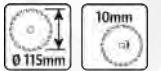

- Material: YG8 tips, tungsten carbide body.

14988 14985



- Material: YG8 tips, tungsten carbide body.

14990 14987



- Material: YG8 tips, tungsten carbide body.

14995

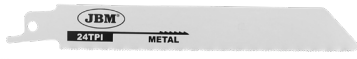

- Material: HSS steel.

14993



- Material: HSS steel.

14994



- Material: high carbon steel.

14991



- Material: high carbon steel.

CUTTING DISCS

- Material: Monocrystalline Fused Alumina SA 50% / White fused alumina 50%

FOR METAL

REF.	DESCRIPTION	Kg	Box	Box	€
14893	T42 - 115x2.5mm	0,05	50	100	2,00€
14894	T42 - 125x2.5mm	0,70	50	100	1,20€
14895	T27 - 115x6mm	0,15	25	100	1,90€
14896	T27 - 125x6mm	0,78	25	100	2,10€



FOR STAINLESS STEEL

REF.	DESCRIPTION	Kg	Box	Box	€
14897	T41 - 115x1mm	0,01	50	400	0,88€
14898	T41 - 125x1mm	0,03	50	400	0,98€
14899	T41 - 115x1.6mm	0,03	50	400	0,88€
14900	T41 - 125x1.6mm	0,04	50	400	0,98€



14893 T42

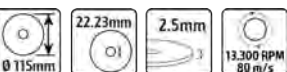

14895 T27



14897 T41



14898 T41



14894 T42



14896 T27



14899 T421



14900 T41



M14 ANGLE GRINDER QUICK CHANGE FAST LOCKING NUT

15014 20,00€

Kg	Box	Box	€
0.10	50	100	-



60008/60028





LIGHTING

- 114 INSPECTION LAMPS
- 118 HEAD TORCHES
- 119 LED MAGNIFYING LAMP
- 120 FLOOD LIGHTS / LAMP CHECK ALIGNERS
/ CIGARRETTE LIGHTERS AND VOLTAGE CONVERTER
- 121 LED BARS
- 122 HIGH BAY LIGHT
- 122 BEACONS
- 125 ACOUSTIC ALARMS
- 126 LED WORK LAMP
- 127 TOWING LIGHT BARS
- 129 REPLACEMENT BULBS AND FUSES SETS

COB LED RECHARGEABLE INSPECTION LIGHT 400LM

53734 23,70€

0.25	20	60	1260
Kg	sub	ft	ft

30-400 Lm	3-4H
LED COB 30lm 10H	LED COB 400lm 2,5H



ROTATING BASE
MAGNETIZED
360°



powerful LED light:
from 30Lm to 400Lm



LIGHT
INTENSITY
SELECTOR



WITH HANGER



USB CHARGER



IN 20 UNITS
DISPLAY CASE

ULTRA SLIM COB LED RECHARGEABLE INSPECTION LIGHT

53519 42,00€

0.20	12	72	720
Kg	sub	ft	ft



IN 12 UNITS
DISPLAY CASE

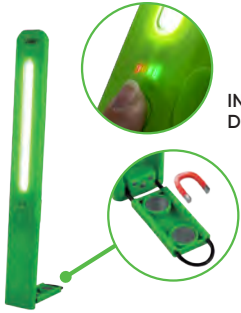

ULTRA SLIM



SLIM COB LED RECHARGEABLE INSPECTION LIGHT

52536 57,00€

0.40	-	10	320
Kg	sub	ft	ft



360mm



LED 2W COB	INTENSITY 3,5H
5-6H	LED 2W COB
200 Lm	3.7V 1900MAH
5-6H	

300 Lm	LED 3W COB	3.7V 8020MA
3H	IP 44	
300LM	150LM	100V
2H	4H	240V
		5V 0.6A

RECHARGEABLE INSPECTION LIGHT WITH MAGNETIC FOLDABLE BASE

54122	38,00€	0.39 Kg	12 SUB	24 1f	384 1f	6500±400 KELVIN	100V 240V	USB	5V 1A	3.7V 2.0Ah	IP 44	257mm	50mm	26mm
						300 Lm	LED 3W COB	LED 3W	3-4H	2.5H	7H			

54123	40,00€	0.39 Kg	12 SUB	24 1f	384 1f	6500±400 KELVIN	100V 240V	USB	5V 1A	3.7V 4.0Ah	IP 44			
						500 Lm	LED 5W COB	LED 3W	6-7H	3H	14H			

54124	47,00€	0.39 Kg	12 SUB	24 1f	432 1f	6500±400 KELVIN	100V 240V	USB	5V 1A	3.7V 4.0Ah	IP 44			
						1000 Lm	LED 10W COB	LED 3W	6-8H	3H	14H			

14031	7,90€	0.10 Kg	10 SUB	100 1f	1152 1f									
--------------	-------	---------	--------	--------	---------	--	--	--	--	--	--	--	--	--

IN 12 UNITS DISPLAY CASE

USB WALL CHARGER ADAPTER

RECHARGEABLE INSPECTION LIGHT WITH DOUBLE BACK MAGNET AND IN THE FOLDABLE

51889	49,00€	0.43 Kg	- SUB	10 1f	360 1f		255mm	56mm
--------------	--------	---------	-------	-------	--------	--	-------	------

60 Lm	x24+6 LED	LITIO 3.7V 1400MAH	3-4H	4-5H
-------	-----------	--------------------	------	------

DOUBLE HOOK AND DOUBLE MAGNET

RECHARGEABLE COB LED INSPECTION LIGHT WITH MAGNETIC FOLDABLE

53216	49,00€	0.60 Kg	- SUB	10 1f	120 1f			
--------------	--------	---------	-------	-------	--------	--	--	--

200 Lm	LED 2W COB	3.7V 2.000MAH	4H	5V 1.000MA	3-4H
--------	------------	---------------	----	------------	------

390mm

100mm

180mm

VAT not included



POCKET FLASHLIGHT WITH BATTERY

53776 19,10€

0.15 12 48 1920



3 LIGHT MODES

90-250 Lm
2,5H

3,5-6H
3.7V 1.5Ah

ABS



IN 12 UNITS DISPLAY CASE



POCKET FLASHLIGHT WITH BATTERY

52987 20,00€

0.17 10 40 720



160mm 30mm 20mm



IN 10 UNITS DISPLAY CASE

120 Lm
LED 3W COB
3.7V 1000MAH
2,5H
2,5H

PORTABLE COB LED WORK LIGHT WITH FOLDABLE BASE

52883 38,00€

0.31 - 20 640



240mm 37mm



180+80 Lm
LED 2W COB
3.7V 1.800MAH
4-5H
3,5-4H

FLEXIBLE COB LED UV WORK LIGHT WITH MAGNETIC BASE

53530 46,00€

0.35 - 20 620



5V 1A
3.7V 2.2Ah
LED 2W COB
4H
4H

FLEXIBLE COB LED WORK LIGHT WITH MAGNETIC BASE

53217 47,00€

0.30 - 20 620

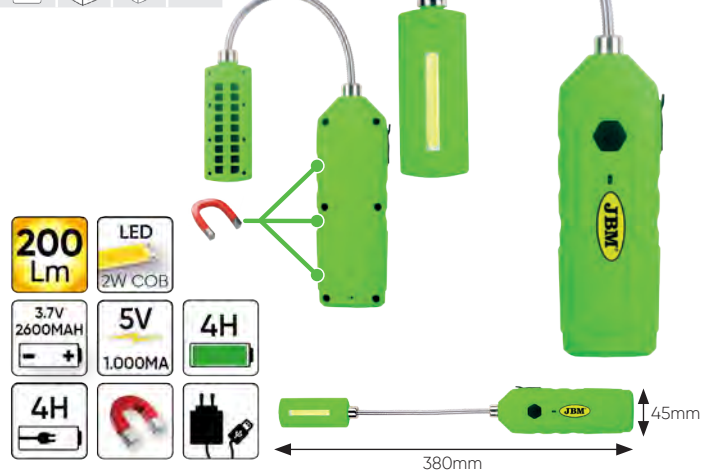

200 Lm
LED 2W COB
3.7V 2600MAH
5V 1.000MA
4H

380mm 45mm

RECHARGEABLE LED WORK LIGHT

53974

38,00€

0.75 5 20 240



1500 Lm

LED 20W COB



ABS



5-6H

100% 2,5h

50% 6h

100% 50% SOS FLASH

Want to see how it works?



37mm
240mm
225mm

4 LIGHTING MODES
100% 50% SOS FLASH



MULTI-POSITION



LED TUBE LIGHT 400LM

53780

14,50€

0.45 5 20 280



400 Lm

220V 240V

6W

IP 20

50Hz

6000-7000 KELVIN

H05SRN-F 2x0.75mm² 5m



2,5M POWER CORD

INCLUDES UPPER HOOK FOR HANDS-FREE LIGHTNING

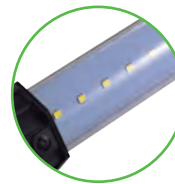

POWERFUL LIGHT TO ILLUMINATE THE WORK AREA



ULTRA-SLIM INSPECTION LAMP WITH LED COB

52384

29,00€

0.33 - 20 600



- Cable length: 5m
- DC Cable length: 0.1M
- DC cable length up tongs: 0.3M

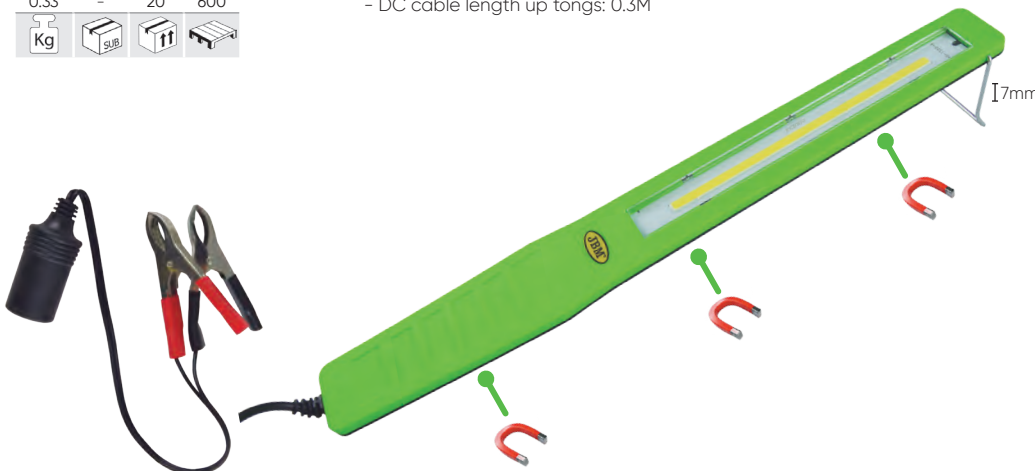

17mm

LED 3W COB

200 Lm

12V 24V

75mm

90mm
325mm

VAT not included



INSPECTION LAMPS



COB HEADLIGHT

54004 23,00€

0.10	12	96	2592
Kg	Sub	ft	ft

COB + LED 350LM

COB 350Lm 5W COB	LED 90Lm 3W XPE		
3.5V 1200Ah	2.5H	IP X4	2m
Gel de sílice Silica gel	70g	USB	Hand



350Lm 150Lm



150Lm 60Lm



- Material: Silica gel.
- Power indicator, induction indicator.
- Motion sensor activation mode.
- USB charging cable included.

MOTION SENSOR BUTTON



Press to activate / deactivate.
Pass your hand in front of the button to turn the light on and off.

GLOVE WITH LED LIGHT

54267 9,50€

0.05	10	60	2640
Kg	Sub	ft	ft



LED



LED

LED	x2 CR2016 Includes included	Derecha / Right
+20H	120mAh	x2 LED 70Lm



HEADLIGHT HEADLIGHT 800LM (COB + CREE)

53569 18,00€

0.30	10	50	400
Kg	Sub	ft	ft

CREE + COB 800LM



MAX 800 Lm	High/Low Flash/COB	x2 18650
LED COB + CREE	150M	+2,5H

RECHARGEABLE BATTERIES

FOCUS REGULATOR



"LIGHT ON" INDICATOR

3 LIGHT MODES



90°



HEADLIGHT HEADLIGHT 350LM

53568 12,00€

0.20	10	100	400
Kg	Sub	ft	ft

High/Low Flash/SOS	2000 mAh LI-ION	MAX 350 Lm
150M	+2,5H	

FOCUS REGULATOR

350LM



3 LIGHT MODES

90°



INSPECTION LAMPS



DESKTOP LED MAGNIFYING LAMP

53227 28,00€

0.60	6	24	192
Kg	Sub	ft	ft

- Up to 500 load cycles.
- White light LED, high savings.
- Extended life and high luminosity.



8 LED MAGNIFYING GLASS (5X)

53085 30,00€

0.31	10	40	1500
Kg	Sub	ft	ft



9 LED PLASTIC FLASHLIGHT

52555 2,38€

0.03	48	192	3456
Kg	Sub	ft	ft

52558 2,38€

0.03	48	192	3072
Kg	Sub	ft	ft

30mm	93mm
------	------



6-LED MAGNETIC PEW FLASHLIGHT

53427 5,00€

0.05	12	96	3456
Kg	Sub	ft	ft

160mm	32mm
-------	------



21 LED FLASHLIGHT

51326 4,40€

0.07	12	144	2880
Kg	Sub	ft	ft



2 LED DYNAMO FLASHLIGHT

51573 2,50€

0.07	12	96	3456
Kg	Sub	ft	ft



PRESENTATION IN INDIVIDUAL BOX

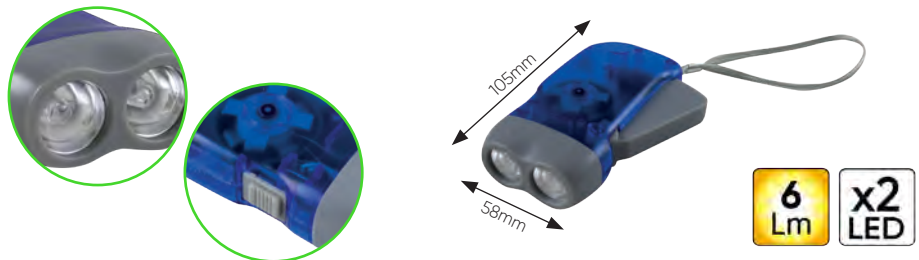

BATTERIES

"AAA" R03 1,5V

51258 0,15€

0.01	60	2400	134400
Kg	Sub	ft	ft



x3

FOR REF. 51325, 51326, 51829, 52233, 51001, 52582, 52555, 52556, 52557, 52558, 52584

9V

10923 1,10€

0.05	10	500	-
Kg	Sub	ft	ft



FOR REF. 52162, 52450, 51929, 50942

50W LED FLOOD LIGHT

53505 77,00€

2.50 - 8 96
Kg SUB IT

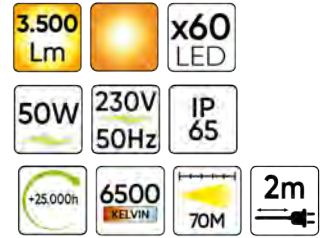

TRIPOD FOR LED FLOOD LIGHT 53505

53506 36,00€

2.40 - 8 96
Kg SUB IT



TRIPOD FOR LED FLOOD LIGHT 52232

52254 64,00€

3.51 - 4 24
Kg SUB IT



- Lamp not included.

↑ 2.770mm
↓ 1.290mm

LAMPCHK HEADLIGHT ALIGNER WITH LUXOMETER

52740 690,00€

24.00 - 1 11
Kg SUB IT

HALOGEN / XENON / LED

- Measurement distance: 50 cm.
- Easy optical axis deviation measurement from the dipped headlight and beam headlight.
- Also for trucks



DOUBLE LAMPCHK HEADLIGHT ALIGNER WITH LASER AND LUXOMETER

52836 1.100,00€

24.85 - 1 10
Kg SUB IT

- Also for trucks
HALOGEN / XENON / LED
REGULATION VERIFICATION SCREEN

DIGITAL LIGHT METER



DOUBLE LASER

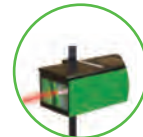

270mm
520mm
1560mm



CIGARETTE LIGHTERS AND VOLTAGE CONVERTER

REF.	DESCRIPTION	FOR	Kg	Sub	IT	
11107	CIGARETTE LIGHTER PLUG 100-240V OUTPUT: 6V 500mA	54122, 54123, 54124, 51889, 52883, 53568	0,06	1	250	4,50€
10961	VOLTAGE CONVERTER 100-240V OUTPUT: 6V 500mA	54122, 54123, 54124, 51889, 52883, 53568, 53569	0,08	-	150	13,00€
11989	CIGARETTE LIGHTER PLUG 100-240V OUTPUT: 9V 500mA	52536	0,04	-	200	2,00€
11093	CIGARETTE LIGHTER PLUG 230V OUTPUT: 6V 500mA	52002	0,06	-	250	4,00€
14031	USB WALL CHARGER ADAPTER INPUT: 100-240V OUTPUT: 5V 1000mA	54122, 54123, 54124, 53216, 53217, 53519, 52987, 52883, 53530, 53451, 53570, 53707, 53439, 53568, 53569	0,1	10	100	7,90€
13839	USB WALL CHARGER ADAPTER 110V/60Hz	54122, 54123, 54124, 54216, 53217, 53519, 2987, 52883, 53530, 53451, 53570, 53707, 53439, 53568,	0,04	-	200	8,50€
14032	USB CIGARETTE LIGHTER ADAPTER INPUT: 12-24V OUTPUT: 5V, 1A/2.1A	53465, 53466, 53467, 53216, 53217, 53519, 52987, 52883, 53530, 53451, 53570, 53707, 53439, 53568, 53569	0,1	10	100	12,00€
14033	USB CABLE LENGTH: 80CM	53216, 53217, 53519, 52987, 53530, 53451, 53570, 53707, 53499	0,1	10	100	4,50€
16052	USB CABLE A TYPE / ROUND PLUG 3.5MM	54172, 54173	0,1	10	100	2,09€
16053	USB CABLE A TYPE / ROUND PLUG 5.5MM	54173	0,1	10	100	2,85€



11107

10961

11989

14031

14032

13839

11093

14033

16052

16053

LED LAMP WITH MAGNETIC HOLDER

54270 42,00€

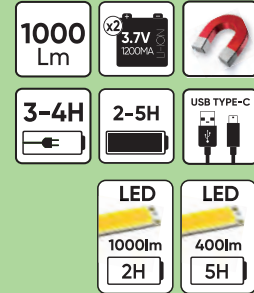
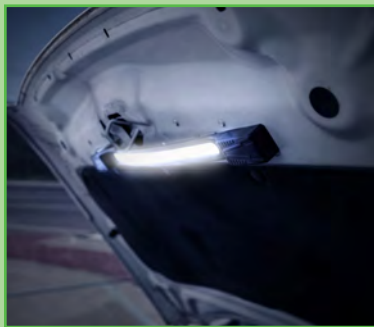
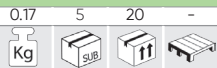

MAGNET LED BAR WITH BONNET STRAP

54271 54,00€

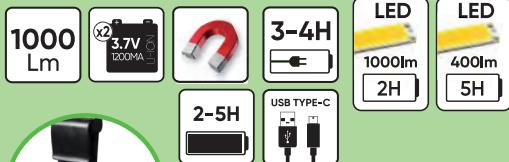
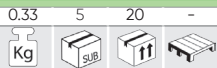

UNDER BONNET MAGNETIC INSPECTION LIGHT

53707 153,00€



MULTIPURPOSE
WITH MAGNETIC SUPPORT
TO ADAPT TO ANY SITUATION

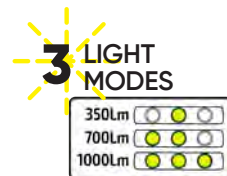

DIRECT LIGHT EXACTLY
WHERE YOU NEED IT



ILLUMINATED BATTERY
STATUS INDICATOR



RECHARGEABLE
BATTERY



INCREASE NOTABLY
VISIBILITY IN THE WORK AREA.

EXTENDABLE UNDER BONNET INSPECTION LIGHT

53570 154,00€



EXTENDABLE ARMS FROM
117CM TO 175CM



DIRECT LIGHT EXACTLY
WHERE YOU NEED IT



ILLUMINATED BATTERY
STATUS INDICATOR



RECHARGEABLE
BATTERY



**3 LIGHT
MODES**



INCREASE NOTABLY
VISIBILITY IN THE WORK AREA



VAT not included

JBM / www.jbmcamp.com

121



INSPECTION LAMPS



LED HIGH BAY LIGHT

54039 154,00€

Ø :50cm x 38cm

2.60 - 1 14



This item is specially designed for lighting industrial environments, workshops and high-rise spaces.

- Driver: Meanwell
- Color temperature: 6500k
- Frequency: 50/ 60 Hz

- Light weight
- Power: 200W
- Luminous flux: 20000Lm
- Diameter: 50cm x 38cm
- Degree of protection: IP20



20.000Lm



SPARE LAMPSHADE

15385 50
18,00€



6 PIECES LED HIGH BAY LIGHT SET

54133 547,00€

12.10 - 6 6

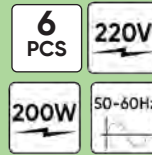

20.000Lm

UFO HIGH BAY LIGHT

54088 132,00€

Ø :29,9cm x 14,7cm

2.50 - 1 63

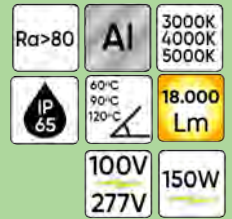
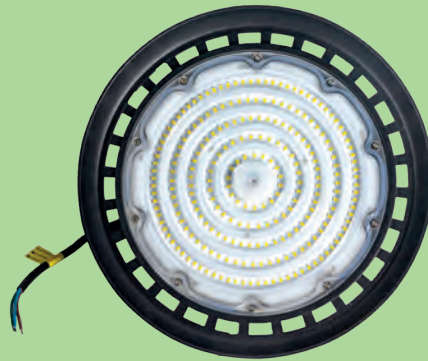

ROTATING LED BEACON MAGNETIC BASE

53691 36,00€

0.70 - 20 320



- Functions:
- Function 1: SINGLE FLASH
- Function 2: DOUBLE FLASH
- Function 3: ROTATION

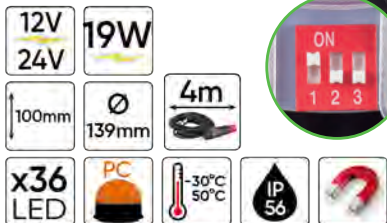

ECE R65 ECE R10

12-24V LED BEACON FLEXIBLE SPIGOT BASE

53690 34,00€

0.55 - 20 200



- Functions:
- Function 1: SINGLE FLASH
- Function 2: DOUBLE FLASH
- Function 3: ROTATION



ECE R10
ECE R65

INSPECTION LAMPS

RECHARGEABLE LED BEACON MAGNETIC BASE

54173 87,00€

0.75	5	20	240
Kg	sub	ff	

- Functions:
 - Function 1: SINGLE FLASH
 - Function 2: DOUBLE FLASH
 - Function 3: ROTATION
- USB CABLE A TYPE / ROUND PLUG 5.5MM



16053 2,85€



Alimentado a batería recargable
Rechargeable battery powered.

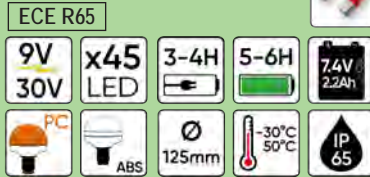

Approved ECE R10 / R65

RECHARGEABLE LED BEACON 9-30V SPIGOT BASE

54172 81,00€

0.80	5	20	240
Kg	sub	ff	

- Functions:
 - Function 1: SINGLE FLASH
 - Function 2: DOUBLE FLASH
 - Function 3: ROTATION
- USB CABLE A TYPE / ROUND PLUG 3.5MM



16052 2,09€



Alimentado a batería recargable
Rechargeable battery powered.

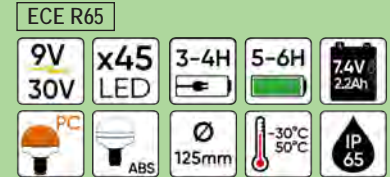

Approved ECE R10 / R65

LED BEACON 12-24V FLEXIBLE SPIGOT BASE

52456 36,00€

0.60	-	20	160
Kg	sub	ff	

- PC lens.
- Anti shock.
- Consumption: 8W.

- Functions:
- Function 1: ROTATION
- Function 2: DOUBLE FLASH
- Function 3: 6 LIGHT



FLASH ROTATING LED BEACON 12-24V

52375 38,00€

0.70	-	20	240
Kg	sub	ff	

- ABS-BAES lens.
- Anti shock.
- Cable: 2,5m with lighter plug.
- Consumption: 9W.

- Functions:
- Function 1: ROTATION
- Function 2: DOUBLE FLASH
- Function 3: 6 LIGHT



ROTATING BEACON H1 12V 55W SPIGOT BASE

51964 28,00€

0.65	-	20	160
Kg	sub	ff	

12V
55W

51965 29,50€

0.68	-	20	160
Kg	sub	ff	

24V
70W

ECE R10
ECE R65
PC

- PC lens.
- Anti shock.
- Lens thread with durable seal.
- Rpm: 40.
- Pinion/worm system.
- Bulb:
- H1, 12V 55W
- H1, 24V 70W
- With threaded base.
- Current consumption: 3.0 A.



ROTATING BEACON CORDLESS

51962 25,00€

0.57	-	20	240
Kg	sub	ff	

12V
55W

51963 29,00€

0.55	-	20	240
Kg	sub	ff	

24V
70W

ECE R10
ECE R65

- ABS - BAES lens.
- Anti-shock.
- Lens thread with durable seal.
- Rpm: 40.
- Pinion/worm system.
- Bulb:
- H1, 12V 55W
- H1, 24V 70W
- Current consumption: 3.0 A.



MAGNETIC BASE ROTATING BEACON WITH COILED CABLE

51960 34,00€

0.75 - 20 240



12V
55W



170mm
Ø 140mm

51961 34,00€

0.78 - 20 240



24V
70W



ECE R10
ECE R65 CE

- ABS - BAES lens.
- Anti shock.
- Lens thread with durable seal.
- Rpm: 40.
- Pinion/worm system.
- Bulb:
- H1, 12V 35W
- H1, 24V 35W
- Cable: 3m spiral with cigarette lighter plug.
- Current consumption: 3.0 A.

FLASHING BEACON

51966 18,00€

0.31 - 50 800



12V
110V

131mm
Ø 99mm
Ø 61mm

- ABS - BAES lens.
- XENON.
- Current consumption: 3.0 A.

THREADED
TULIP-SHAPED BASE



LOW PROFILE LED FLASHING ROTATING BEACON

52827 46,00€

0.50 - 20 400



52910 39,00€

0.50 - 20 320



52828 43,00€

0.54 - 20 320



CE ECE R10

- 3 function switches.
- 3 flashing modes:
- ROTATING
- 6 FLASHING
- DUAL FLASH



SPARE LAMPS

FOR REF. 51966

11103 6,00€

0.01 - 100 -



FOR REF. 51960, 51962, 51964

10766 1,59€

0.01 - 200 -



HOOD ANTI-SHOCK

51969 14,00€

0.12 - 50 1000



120mm
Ø 128mm

11325 17,50€

0.12 - 50 451



11324 17,50€

0.13 - 100 -



POLE CONNECTORS

FOR REF. 51964, 51965,
52300, 52456, 52549, 53131

10750 13,00€

0.25 - 50 -



FOR REF. 51964, 51965,
52300, 52456, 52549, 53131

10751 15,00€

0.30 - 50 -



EXTENDABLE BAR FOR ROTATING BEACON

52843 31,60€

0.90 - 20 1500

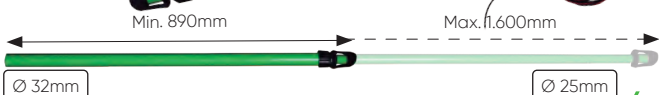

ACOUSTIC ALARM 12V-80V

51967 16,00€

0,20	10	50	1200
Kg	Sub	ff	ff



12V 80V | 12V 80V | 107 dBa | -30°C 70°C | IP 65

51968 16,00€

0,23	10	50	1000
Kg	Sub	ff	ff



- 107 dB.
- Resistant to different climatic conditions.
- Can be washed with pressurized water.

- Protected from inverse polarities.
- Sealed with epoxy resins.
- Temperature range: -30 to 70°C.

FORKLIFT SAFETY LIGHT

54078 68,00€

0,66	-	20	200
Kg	Sub	ff	ff

10V 60V | 15W



Oval security light with 2 blue LEDs. The light is projected on the ground with a blue concentrated light as a warning for pedestrians in the area.



This warning light allows to avoid collisions and accidents between forklifts and people, and increases safety in work environments, especially in blind spots. Perfect for noisy environments.

Universal support

LED WORK LIGHT SCATTERED LIGHT

53428 18,00€

0,50	5	20	480
Kg	Sub	ff	ff

1.800 Lm | 10V 30V | x9 LED 27W | LED | IP 67 | 6000 KELVIN | AL



52566 28,00€

1,00	-	10	360
Kg	Sub	ff	ff

1.450 Lm | 10V 40V | x9 LED 3W | LED | +30.000h | IP 68 | AL

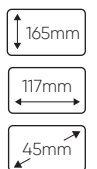

53429 18,00€

0,40	5	20	480
Kg	Sub	ff	ff

1.800 Lm | 10V 30V | x9 LED 27W | LED | IP 67 | 6000 KELVIN | AL



52567 29,00€

0,90	-	10	400
Kg	Sub	ff	ff

1.450 Lm | 10V 40V | x9 LED 3W | LED | +30.000h | IP 68 | AL

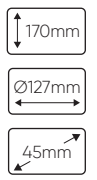

52302 25,40€

0,80	5	20	480
Kg	Sub	ff	ff

1.450 Lm | 10-40V 27W | x9 LED 3W | LED | IP 68 | +30.000h | AL

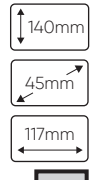

53049 89,00€

1,53	-	10	468
Kg	Sub	ff	ff

3.600 Lm | 9-36V 40W | x4 LED 10W | LED | IP 68 | +30.000h | AL

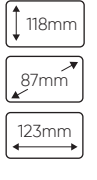

BEACONS



LED WORK LIGHT SCATTERED LIGHT

52303 26,40€

0.76 5 20 640



1.450 Lm **x9 LED 3W**

Al **10-40V 27W** **IP 68** **+30.000h**



53052 158,00€

2.65 - 6 144



7.200 Lm **x8 LED 10W**

Al **9-36V 80W** **IP 68** **+30.000h**

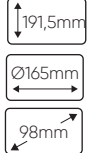

53045 35,00€

1.00 - 12 480



2.880 Lm **x16 LED 3W**

Al **9-36V 46W** **IP 68** **+30.000h**



53046 39,00€

0.74 - 12 480



2.272 Lm **x16 LED 1.5W**

Al **9-36V 24W** **IP 68** **+30.000h**



LED WORK LIGHT SPOTLIGHT

52568 28,00€

0.75 - 10 400



1.450 Lm **x9 LED 3W** **10V 40V**

+30.000h **IP 68** **Al**



53048 89,00€

1.50 - 10 1000



3.600 Lm **x4 LED 10W**

Al **9-36V 40W** **IP 68** **+30.000h**

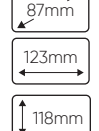

52569 28,00€

0.70 5 20 320



1.450 Lm **x9 LED 3W** **10V 40V**

+30.000h **IP 68** **Al**



53051 158,00€

2.75 - 6 468



7.200 Lm **x8 LED 10W**

Al **9-36V 80W** **IP 68** **+30.000h**



52415 19,00€

0.60 5 20 480



1.450 Lm **x9 LED 3W**

10V 40V **+30.000h** **IP 68** **Al**



53047 330,00€

3.51 - 4 40



3.200 Lm **x10 LED 5W**

Al **12-24V 80W** **IP 67** **+30.000h**



52414 19,00€

0.55 5 20 480



1.450 Lm **x9 LED 3W**

10V 40V **+30.000h** **IP 68** **Al**



+30.000h **280cm**



REMOTE DISTANCE 100M

ADJUSTABLE SPEED OF MOVEMENT

ROTARY



RING TRAILER LIGHTING BOARD WITH REAR LIGHTS AND 2 TRIANGULAR REFLECTORS

54163 80,00€

1.85 - 6 54

Kg SUB 11

x42 LED 12V 24V 7.5m 7PIN IP 65

140mm 110mm

- 4 functions:
Position and registration.
Brake light.
Slide direction indicator.
Mass.

Dynamic lights

Regulation	Homologation number
3	E9*3R02/17*23444*00
4	E9*4R00/19*23444*00
6	E9*6R01/29*23444*00
7	E9*7R02/27*23444*00
10	E9*10R06/00*22232*02

MAGNETIC REAR LIGHTS AND TRIANGULAR REFLECTORS SET

54162 81,00€

1.50 - 6 144

Kg SUB 11

x42 LED 12V 24V 7.5m 7PIN IP 65

140mm 110mm

- 4 functions:
Position and registration.
Brake light.
Slide direction indicator.
Mass.

Dynamic lights

Approved E9*7R02/27*23444*00

93mm 58mm 118mm

TRAILER BOARD METAL 1.4-2.1M TELESCOPIC

54161 90,00€

2.75 - 6 48

Kg SUB 11

x42 LED 12V 24V 7.5m 7PIN IP 65

1,4-2,1m

- 4 functions:
Position and registration.
Brake light.
Slide direction indicator.
Mass.

Dynamic lights

Approved E9*7R02/27*23444*00

Regulation	Homologation number
3	E9*3R02/17*23444*00
4	E9*4R00/19*23444*00
6	E9*6R01/29*23444*00
7	E9*7R02/27*23444*00
10	E9*10R06/00*22232*02

SET OF 2 WIRELESS MAGNETIC LED REAR LIGHTS

54044 99,00€

1.15 - 6 168

Kg SUB 11

2.4 GHz -10°C 50°C WIRELESS

2-3H 10H

IP65 Transmitter de radio Receiver de radio 12V 24V 20m

7 PINS

USB Car charger

35mm 100mm 98mm

1m

Charging cable

Approved E9*178R00*1448 E9*150R00*1448

Transmitter

REAR LIGHT FOR TOWING LIGHT BAR

53151 14,00€

0.20 5 20 900

Kg SUB 11

99mm 100mm 39mm 12V

- 4 functions:
● Blue: Position and registration.
● Red: Brake light.
● Yellow: Slide direction indicator.
○ White: Mass.

LED LIGHT FOR TOWING LIGHT BAR

54160R 17,50€ **54160L** 17,50€

0.20 5 20 880

Kg SUB 11

12V 24V x42 LED IP 65

93mm 118mm 46mm 93mm

- 4 functions:
● Black: Position and registration.
● Red: Brake light.
● Green: Slide direction indicator.
○ White: Mass.

Dynamic lights

Approved E9*7R02/27*23444*00

TRAILER ADJUSTABLE TOWING LIGHT BAR

1,4 TO 2,1M - 6m CABLE

52458 58,00€

2.60	-	6	48
Kg	Sub	↑↑	⊞

12V 7 PINS 1.400mm 2.100mm

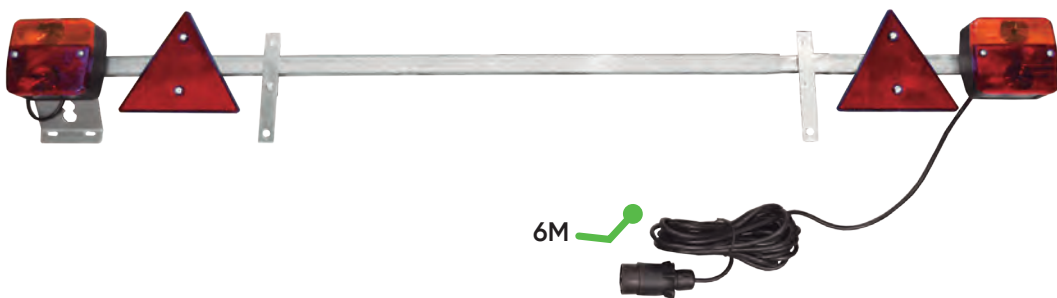

TRIANGULAR REFLECTOR FOR REF.52458, 52848, 52838, 50810, 51886, 52839

16158 9,00€

52848 88,00€

2.49	-	6	36
Kg	Sub	↑↑	⊞



TRIANGULAR REFLECTOR FOR REF.52458, 52848, 52838, 50810, 51886, 52839

16158 9,00€

Approved E4 7R-0218756

TRAILER TOWING BAR WITH 2 REAR LIGHTS AN 2 TRIANGULAR REFLECTORS 5m CABLE

50910 45,00€

1.90	-	6	54
Kg	Sub	↑↑	⊞

12V 7 PINS LED 140mm 1100mm

Approved E4 7R-0218756

Material: HDPE

- Functions:
- Position light
- Number plate light
- Slide direction indicator
- Brake



52838 56,00€

1.85	-	6	54
Kg	Sub	↑↑	⊞

TRIANGULAR REFLECTOR FOR REF.52458, 52848, 52838, 50810, 51886, 52839

16158 9,00€



2 MAGNETIC REAR LIGHTS AND 2 TRIANGULAR REFLECTOR SET

51886 44,00€

1.50	-	8	120
Kg	Sub	↑↑	⊞

Plain cable: 7m
Spiral cable: 2,5m

52839 64,00€

1.47	-	8	128
Kg	Sub	↑↑	⊞

Approved E4-7R-0218756

118mm 123mm 87mm LED

7 PINS 12V



16158 9,00€

TRIANGULAR REFLECTOR FOR REF.52458, 52848, 52838, 50810, 51886, 52839



TRAILER LIGHT TESTER 7/13 PINS

53536 34,00€

0.40	4	24	432
Kg	sub	ff	



7-13 pins

9V



7-PIN EXTENSION

- This tester has a 13-pin socket on each end to be connected to the trailer and car plug.
- It quickly indicates if there is any damage to the wiring of the car or the trailer.
- Also useful for checking caravans and bicycle stands.
- It has two exits: one for

the outlet of the vehicle and another for the intake of the trailer.

- Includes a 13 to 7 pin adapter.
- 9V battery.



13 PINS



7 PINS



14753 13,00€

0.20	-	50	-
Kg	sub	ff	

- Including 7-pin plug and 7-pin socket
- Cable size: 20cm x 0,5mm²

TRAILER LIGHTS TESTER 7 PINS

51929 22,00€

0.90	4	24	1144
Kg	sub	ff	

7 pins

9V

- This tester has an outlet to connect the 7 pole plug of the towline on one side and the 7 pole plug of the car on the other side.
- This tester indicates rapidly if there is no damage in the car or the towline cables.
- It is also useful for testing caravans and bicycle

mounts.

- It is equipped with two outlets, one for the vehicle outlet and another for the towline inlet.



TOWAGE INLET



VEHICLE OUTLET



REPLACEMENT BULBS AND FUSES SET

12V H9



12V

12V H11



12V

12 V HB3



12V

12V HB4



12V

12V H7+H1



12V

51615 5,95€

0.09	10	100	1500
Kg	sub	ff	

51612 5,95€

0.09	10	100	1500
Kg	sub	ff	

50523 4,70€

0.09	10	100	1500
Kg	sub	ff	

50524 4,70€

0.09	10	100	1500
Kg	sub	ff	

50915 4,20€

0.10	10	100	1800
Kg	sub	ff	

12 V H1



51613 2,90€

0.90	10	100	1500
Kg	sub	ff	

12V

H4



51614 3,60€

0.10	10	100	1800
Kg	sub	ff	

12V

52047 3,30€

0.09	10	100	1500
Kg	sub	ff	

24V

H7



50431 3,80€

0.08	10	100	1800
Kg	sub	ff	

12V

52048 3,95€

0.10	10	100	1500
Kg	sub	ff	

24V

CAR BULB CABINET

50551 350,00€

560mm 650mm

9,39	-	1	14
Kg	Sub	11	14

1 Pole stop

P21W 21W BA15s 30 units
P21WA 21W BA15s Amber 10 u.
PY21W 21W BAU15s
Ambo Desc. 10 units

2 Pole stop

R21/5W 21/5W BAY15d 40 units
INTERIOR LIGHT
C5W 5W SV8.5 11 x 38 22 units

Pilot lamps

R5W 5W BA15s 30 units
R10W 10W BA15s 30 units

Indicator lamps

T4W 4W BA9s 22 units

Halogen lamps

H1 55W P14.5s 10 units
H2 55W X511 4 units
H3 55W PK22s 4 units
H4 60/55W P43t 10 units
H7 55W PX26d 10 units
HB3 65W P20d 4 units
HB4 55W P20d 4 units
H9 65W PGJ19-5 4 units
H11 65W PGJ19-2 4 units

European lamp

T5 1.2W W2.1 x 4.6d 20 units
T10 5W W2.1x9.6d 12 units
T10 3W W2.1x9.6d 12 units
T13 10W W2.1x9.6d 10 units
T15 18W W2.1x9.6d 10 units
T20 21W W5x16d 10 units
T20A 21W W5x16d Amber 10 u.
T20 21/5W W5x16d 10 units

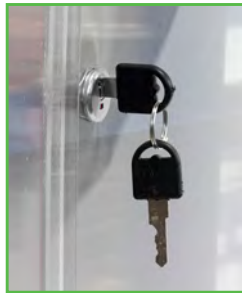

OBN BULBS

H7	H4	H1	H1 55W	H3	BA15S	2 POLOS
52365 2,46€	52364 2,86€	52362 1,23€	10766 1,59€	52363 1,23€	53203 0,46€	52369 1,19€
0.02 10 200 9000	0.02 10 200 4400	0.01 10 200 14400	0.01 - 200 -	0.02 10 200 14400	0.01 10 200 -	0.01 10 1000 18000
Kg Sub 11 14	Kg Sub 11 14	Kg Sub 11 14	Kg Sub 11 14	Kg Sub 11 14	Kg Sub 11 14	Kg Sub 11 14
12V - Pack: Box 1pcs 55W	12V - Pack: Box 1pcs 60-55W	12V - Pack: Box 1pcs 55W	12V - Pack: Box 1pcs 55W	12V - Pack: Box 1pcs 55W	12V - Pack: Box 10pcs. 21W - No cap 21-55W AMBER	12V - Pack: Box 10pcs. 21-55W 20
T20A	R5W	WEDGE T20	T20	T20	T13	T15
52368 1,14€	53007 0,42€	52862 1,15€	52370 1,17€	52864 1,20€	52865 0,50€	52866 0,25€
0.01 10 1000 18000	0.05 10 200 1500	0.01 10 1000 1500	0.01 10 1000 18000	0.01 10 500 1500	0.01 10 2000 -	0.01 10 2000 25000
Kg Sub 11 14	Kg Sub 11 14	Kg Sub 11 14	Kg Sub 11 14	Kg Sub 11 14	Kg Sub 11 14	Kg Sub 11 14
12V - Pack: Box 10pcs. 21W - No cap	5V - Pack: Box 10pcs. 12W - Type BA15S	12V - Pack: Box 10pcs. 21W - W3x16d	12V - Pack: Box 10pcs. 21W - No cap	12V - Pack: Box 10pcs. 21/5W - W3x16q	12V - Pack: Box 10pcs. 10W - No cap	12V - Pack: Box 10pcs. 18W - Type

CAR BULBS FOR VEHICLES



PNEUMATIC TOOLS

- 132 IMPACT WRENCHES
- 134 IMPACT WRENCHES FOR TRUCKS
- 135 DRILLS
- 136 POLISHERS
- 137 GRINDERS
- 138 PNEUMATIC BEAD BREAKER
- 139 SANDERS / POLISHERS
- 141 AIR IMPACT WRENCH
- 142 CUTTING TOOLS
- 143 AIR INFLATOR GUNS
- 144 OIL FILTERS
- 145 OTHER GUNS
- 146 AIR HOSE REEL
- 147 AIR HOSES
- 148 CONNECTOR HOSES / THREADS

IMPACT WRENCH 1/2" COMPOSITE

53520 228,00€

2.40 5 10 160



1756Nm

COMPOSITE

REPAIR KIT FOR 53520

14121 26,00€

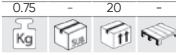

NANO IMPACT WRENCH 1/2"

53588 164,00€

1.65 - 5 385



REPAIR KIT FOR 53588

14165 26,50€



MINI IMPACT WRENCH 1/2" COMPOSITE

51206 228,00€

COMPOSITE

1.46 5 10 300



REPAIR KIT FOR 51206

14120 22,00€



ANGLE IMPACT WRENCH 1/2"

53733 238,00€

1.30 5 10 280



650Nm

REPAIR KIT FOR 53733

14633 22,50€



IMPACT WRENCH 1/2"

53608 98,00€

2.35 5 10 300



REPAIR KIT FOR 53608

14583 6,00€



AIR IMPACT WRENCH 1/2" COMPOSITE

53689 238,00€

2.10 5 10 140



COMPOSITE



REPAIR KIT FOR 53689

14618 19,00€



SPEED AND POWER ONE-HAND ADJUSTMENT

AIR IMPACT WRENCH 1/2"

53726 128,00€

2.35 - 10 240



15564 11,90€



AIR IMPACT WRENCH 3/4" WITH EXTENDER 15cm COMPOSITE

51210 650,00€

4.49 - 4 60



COMPOSITE



REPAIR KIT FOR 51210

14122 34,00€



15,24cm

AIR IMPACT WRENCH 1" WITH 1) cm EXTENDER COMPOSITE

51213 690,00€

4.93 - 4 60



COMPOSITE

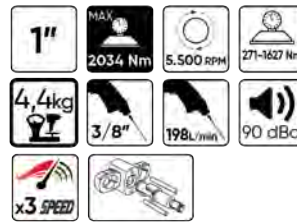

REPAIR KIT FOR 51213

14123 33,00€



19cm

AIR IMPACT WRENCH 3/4" COMPOSITE

51212 488,00€

3.77 - 4 128



COMPOSITE

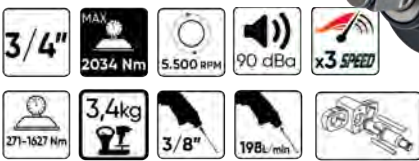

REPAIR KIT FOR 51212

14122 34,00€



AIR IMPACT WRENCH 1" COMPOSITE

51211 560,00€

3.86 - 4 60



COMPOSITE



REPAIR KIT FOR 51211

14123 33,00€



JBM RECOMMENDS THE USE OF ITS LUBRICANT OILS TO OPTIMIZE PERFORMANCE AND EXTEND LIFESPAN OF AIR TOOLS

ON PAGE 144

14534 600ML



14560 100ML



1" LONG NOSE AIR IMPACT WRENCH FOR TRUCKS

52814 528,00€

3260Nm

22,25 - 1 24
Kg SUB IT

- Side air outlet.
- Easy speed regulation tightening and loosening.

670mm



1"	MAX 3260 Nm	3.600 RPM	18,5kg
424 L/min	1/2"	6 bar	90 PSI 18 CFM
x6 SPEED	111 dB	25 m ³ /h	

32, 33mm



220mm

REPAIR KIT FOR 52814

14153 20,50€

0,05 - 15 -
Kg SUB IT



1" LIGHT WEIGHT LONG NOSE AIR IMPACT WRENCH FOR TRUCKS

53681 743,00€

2441Nm

798 - 2 50
Kg SUB IT

1"	MAX 2441 Nm	6.000 RPM	7,1kg
300-1945 Nm	1/2"	6.3 bar	282 L/min
90 PSI 10 CFM	185mm	522mm	
90 dBa	doble martillo twin hammer		

522mm



REPAIR KIT FOR 53681

14336 58,00€

1,17 10 10 -
Kg SUB IT

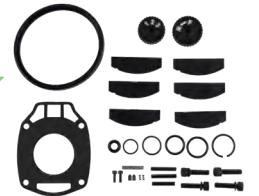

IMPACT WRENCH 1/2"

51222 128,00€

101Nm

1,09 - 20 240
Kg SUB IT

1/2"	MAX 101 Nm	10.000 RPM	0,9kg
7-68 Nm	6.3 bar	360°	
1/4"	85 L/min		



REPAIR KIT FOR 51222

14131 24,00€

0,01 - 10 -
Kg SUB IT



BUTTERFLY DRIVE

90° ANGLED DRILL 3/8"

51221 199,00€

1,27 - 10 120
Kg SUB IT

- Reversible on both sides.
- Rubber finish.

3/8"	1.500 RPM	1,2kg
1/4"	113 L/min	
85 dBa	90°	3/8"
		Ø 9,5mm



REPAIR KIT FOR 51221

14130 21,00€

0,01 - 10 -
Kg SUB IT



1/4" CLOSE-END AIR RATCHET WRENCH COMPOSITE

51225 198,00€

0.89 5 10 120



- Kit It includes:
1/4" to 3/8" converter.
1/4" tip head.
Set of 2 flat tips + 2 ring tips.

COMPOSITE

40,7Nm



REPAIR KIT FOR 51225

14132 21,50€

0.01 - 10 - -



REVERSIBLE DRILL 1/2" COMPOSITE

51220 240,00€

1.64 - 10 120



- Reversible on both sides.

COMPOSITE

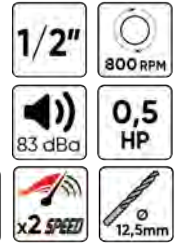

REPAIR KIT FOR 51220

14129 12,50€

0.01 - 10 - -



1/2" MINI AIR RATCHET COMPOSITE

53784 148,00€

0.55 5 20 1200



COMPOSITE



133mm

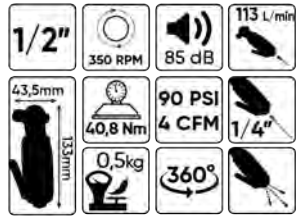

REPAIR KIT FOR 53784

14779 33,00€

0.05 - 10 - -



1/4" MINI AIR RATCHET COMPOSITE

51214 148,00€

0.55 5 20 -



COMPOSITE



133mm



REPAIR KIT FOR 51214

14124 20,50€

0.25 - 10 - -



1/2" AIR RATCHET

51215 119,00€

1.55 5 20 240



- Ball bearing.
- Air regulator.



REPAIR KIT FOR 51215

14125 19,50€

0.33 - 10 - -



ORBITAL GRINDER COMPOSITE 1/4"

51218 288,00€

2.27 5 10 120



- Rubber finish.
- Increased grip.
- Reversible lever.

COMPOSITE



REPAIR KIT FOR 51218

14127 32,50€

0.01 - 10 - -



PNEUMATIC CV JOINT BOOT EXPANDER

51861 199,00€

4.00	-	2	32
Kg	Sub	Box	Tray

- Material: Aluminum.
- Aperture 20 to 100mm.

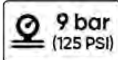

LONG REACH AIR CUT-OFF TOOL

51219 222,00€

2.10	5	10	120
Kg	Sub	Box	Tray

- Rubber finish.
- Increased grip.
- Safety lever with 8 settings.

400mm

SPARE PARTS ON PAGE 142

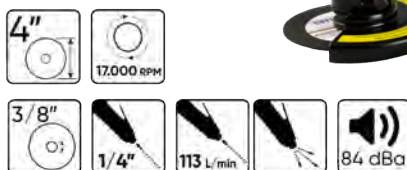

ANTI-SPARKLES PROTECTOR

REPAIR KIT FOR 51219

14128 13,50€

0.01	-	10	-
Kg	Sub	Box	Tray



MINI AIR SANDER SET

51226 233,00€

1.52	-	10	120
Kg	Sub	Box	Tray

- Rubber finish.
- Increased grip.
- Safety lever.
- It includes goggles, levers and discs.



REPAIR KIT FOR 51226

14133 16,50€

0.01	-	10	-
Kg	Sub	Box	Tray



SPARE PARTS ON PAGE 142

AIR CUT-OFF TOOL SET

51227 193,00€

2.03	-	10	120
Kg	Sub	Box	Tray

- Rubber finish.
- Reversible lever (eliminates sparks and waste).
- MINI design.
- It includes goggles, levers, allen key and 10x3" discs.

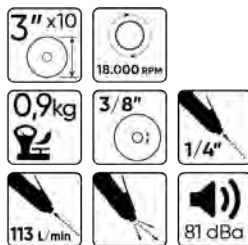

REPAIR KIT FOR 51227

14134 17,50€

0.01	-	10	-
Kg	Sub	Box	Tray



SPARE PARTS ON PAGE 142

AIR SURFACE PREPARATION TOOL SET

51216 650,00€

4.33	-	4	16
Kg	Sub	Box	Tray

- It includes:
 - Different types of wheels (for preparation of metal surfaces prior to remediation of work).
 - 11mm - wire brush (fine).
 - 23mm - wire brush (fine).
 - 11mm - wire brush (thick).
 - 23mm wire brush (thick).
 - Rubber remover.

- Water base paint remover.
- 23mm adapter for rubber remover and wire brush.
- 11 mm wire brush adapter.
- Black rubber polisher (up to 6 pieces).
- Rubber polisher single adapter.
- Double strip rubber adapter.
- Allen.



19 PCS

1,2kg

ANATOMICAL HANDLE

ACCESSORIES

ADAPTERS

For 23mm wheel w/tor	For 11mm wheel w/tor	For double black wheel w/tor	For single black wheel w/tor
51439 26,00€	51440 28,00€	51441 26,00€	51442 28,00€
0.10 - 100 - 800	0.10 - 100 - 800	0.10 - 50 - 800	0.10 - 50 - 800
Kg	Sub	Box	Tray

BRUSHES

Angled brush 23mm	Angled brush 11mm	Fine flat brush 23mm	Fine flat brush 11mm
51388 22,00€	51389 22,00€	51390 22,00€	51391 22,00€
0.10 - 100 - 800	0.05 - 1 - 800	0.05 - 100 - 800	0.04 - 1 - 800
Kg	Sub	Box	Tray

SCRAPER WHEELS

Paint scraping brush 0105mm

51392 34,00€
0.20 - 100 - 800
Kg

Water point scraping brush 0105mm

51393 34,00€
0.20 - 50 - 800
Kg



AIR TOOL REPAIR KIT FOR 51216

14126 54,00€

0.01	-	10	-
Kg	Sub	Box	Tray

VALVE LAPPING TOOL FOR DRILL

54033 49,00€

0.30	5	20	720
Kg	Sub	Box	Tray

- Suction pad diameter: 16, 20, 30, 35, 40mm
- Drill connection: 8mm
- Length: 128mm
- Maximum working speed: 1250rpm



AIR CAULKING GUN

53567 43,00€

1.05	-	10	180
Kg	Sub	Box	Tray

- Working pressure: 2,5-5 BAR.
- Air inlet: 1/4".
- Cartridge capacity: 310ml.



COMPACT AIR DIE GRINDER

3/8" 6mm

51245 99,00€

0.60 - 20 240

Kg SUB 11 1

160mm



3/8" 25,000 RPM 0,4kg

1/4" 113L/min 77 dBa

REPAIR KIT FOR 51245

14135 12,50€

0.01 - 10 -

Kg SUB 11 1



1/4" MINI DIE GRINDER

53137 38,00€

0.55 5 20 720

Kg SUB 11 1

153mm



1/4" 90 PSI 6 CFM

25,000 RPM 0,32kg



IMPACT WRENCH 3/4"

53343 285,00€

790 - 2 72

Kg SUB 11 1

1600Nm



3/4" MAX 1600 Nm 4,600 RPM

245mm 90 PSI 9 CFM

254 L/min x6 SPEED



IMPACT WRENCH 1"

53344 295,00€

8.05 - 2 80

Kg SUB 11 1

1600Nm



1" MAX 1600 Nm 4,600 RPM

245mm 90 PSI 9 CFM

254 L/min x6 SPEED



1/4" AIR DIE GRINDER

53141 68,00€

0.60 5 20 1120

Kg SUB 11 1



18,000 RPM 0,4kg

1/4" 90 PSI 5 CFM

1/4" AIR ANGLE GRINDER

52528 49,00€

0.70 5 20 960

Kg SUB 11 1

20,000 RPM

1/4" 90°

SAFETY TRIGGER

- Aluminum body with rubber handle.
- Useful for polishing, deburring.





AIR RECIPROCATING SAW

52574 69,00€

0.73 4 20 640

Kg SUB 11 1

235mm



9,000 RPM 1/4" 6 bar 90 PSI

- 2 replacement saw 95mm - 32 teeth.
- 2 allen key.
- 1 saw protector.
- Quick coupler.

24 TEETH REPLACEMENT SAW FOR WOOD

11956 5,50€

0.03 10 300 -

Kg SUB 11 1

32 TEETH REPLACEMENT SAW FOR IRON

11957 5,50€

0.01 10 250 -

Kg SUB 11 1

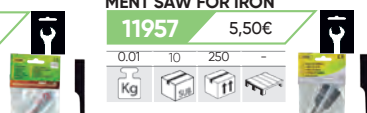

AIR RIVETER

52575 119,00€

1.75 5 10 140

Kg SUB 11 1

2,4mm (3/32), 3,2mm (1/8), 4,0mm (5/32), 4,8mm (3/16)



- Traction: 1586LBS / 720 KGS.
- Length: 9/16" - 14MM.
- Max. 60FT IB / 23-69NM.
- Air consumption: 0.03CFM/0.86L/MIN.
- Air inlet size: 1/4".

It includes:

- O-Rings - Safety cup to collect spent rivets
- 2 Multi-tools
- Quick hitch



AIR POWER SHEAR

53541 168,00€

1.60	5	10	-
Kg	sub	ft	

- Professional air metal shear ideal for cutting steel and other metals, with a cutting capacity of 1,02mm.
- Designed for smooth operation with aluminium trigger, easy to use.
- Precision hardened gearing to make straight cuts and contour cuts.

1/4"	2.900 RPM	1,3kg
113 L/min	230mm	MIN: 1,02mm



REPAIR KIT FOR 53541

14136 12,00€

0.01	5	-
Kg	sub	ft



3" LONG REACH AIR CUT-OFF TOOL

53140 98,00€

0.99	14	400
Kg	sub	ft

18.000 RPM	1kg
1/4"	90 PSI 5 CFM
Ø 75mm	



DISC FOR REF. 53140

14013 3,50€

0.01	1000	-
Kg	sub	ft

PNEUMATIC SPOT-WELD DRILL WITH DISPLACEMENT DRILL

52724 381,00€

2.55	6	84
Kg	sub	ft

1/4"

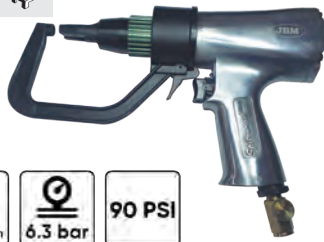

1.800 RPM	8-6.5mm	6.3 bar	90 PSI
-----------	---------	---------	--------

52725 349,00€

2.35	10	180
Kg	sub	ft

1/4"



1.600 RPM	8-10mm	6.3 bar
-----------	--------	---------

SPOTWELD DRILL BIT FOR REF. 52725 Y 52724



13817 17,00€

0.10	500	-
Kg	sub	ft

6,5mm

13818 20,50€

0.10	500	-
Kg	sub	ft

8mm

PNEUMATIC TYRE BEAD BREAKER

53542 980,00€

6.35	4	40
Kg	sub	ft

- Professional pneumatic bead breaker specially designed to be used on agricultural, ATV, small OTR and most truck tires.
- Extremely Fast - saves time over conventional hydraulic bead breakers.
- Excellent for working on the tire without removing the wheel: Loosens tire bead from the rim with leverage.
- Allows to change the wheel outside the garage shop, in-place repair.

SPECIAL FOR AGRICULTURAL/ INDUSTRIAL VEHICLES



- Specifications:
- Air inlet: 1/4".
- CFM: 113 L/min.
- Length: 396mm.
- Weight: 4,6kg.
- 10.000 RPM

AIR TOOL REPAIR KIT FOR 53542

14137 131,00€

0.65	5	5	-
Kg	sub	ft	



AIR VALVE LAPPER SET - PERCUSSION AND ROTATION

53572 348,00€

1.90	5	80
Kg	sub	ft

- Contents:
- 1x Air Engine Valve Lapper.
- 5x Suction Pads (16, 20, 30, 35 and 45 mm).
- 5x Valve Stem Adaptors.
- 1x 3 mm Allen Key.



SUCTION RUBBERS

14157 8,30€

0.01	50	-
Kg	sub	ft

16mm

14158 9,95€

0.01	50	-
Kg	sub	ft

20mm

14159 12,60€

0.01	50	-
Kg	sub	ft

30mm

14160 12,80€

0.01	50	-
Kg	sub	ft

35mm

14161 13,70€

0.10	50	-
Kg	sub	ft

40mm



URNS RIGHT +
URNS LEFT



1/4"	800BPM	1/4"
50L/min	1.8 CFM	
289mm		

ORBITAL SANDER WITH DUST COLLECTOR

52676 98,00€

1.45	5	10	80
Kg	Sub	11	11



10,500 RPM	0,98kg	1/4"	84 L/min	Ø 150mm	5mm
360°	90 PSI	4 CFM	90°		

- Aluminium body with rubber grip.
- With tube and aspiration bag.

ORBITAL SANDER WITH VACUM ATTACH.

52675 84,00€

1.25	5	10	160
Kg	Sub	11	11

52758 88,00€

1.33	5	10	160
Kg	Sub	11	11

200mm

Aluminium body with rubber grip



10,500 RPM	0,9kg	1/4"	84 L/min
360°	90 PSI	4 CFM	90°

DISKS FOR ORBITAL SANDERS

6 HOLES DISK FOR 52675, 52758, 52676, 52376

0.14	50	-
Kg	Sub	11

Ø 150mm

12009 11,00€

0.14	50	-
Kg	Sub	11

Ø 150mm

66 HOLES DISK FOR 52675, 52758, 52676, 52376

0.65	5	50	-
Kg	Sub	11	11

Thread 5/16" Ø 149mm

13500 12,90€

0.65	5	50	-
Kg	Sub	11	11

Thread 5/16" Ø 149mm

15 HOLES DISK FOR 52675, 52758, 52676, 52376

0.10	50	1500
Kg	Sub	11

Thread 5/16" Ø 147mm

13499 12,50€

0.10	50	1500
Kg	Sub	11

Thread 5/16" Ø 147mm

3" AIR POLISHER KIT

53576 189,00€

1.85	-	5	70
Kg	Sub	11	11

- Kit It includes:
- 1x 3" mini polisher.
- 1x Velcro sanding disc (installed).
- 1x wrench for nuts.
- 3x polishing sponges with Velcro backing.



3"	91 L/min	1/4"
2500 RPM	90 PSI	

ADJUSTABLE SPEED

WOOL POLISHING PAD FOR ITEM 53576

14162 25,50€

0.05	50	-
Kg	Sub	11

SPONGE HARD PAD FOR ITEM 53576

14164 25,50€

0.50	5	50	-
Kg	Sub	11	11

SPONGE SOFT PAD FOR ITEM 53576 - WHITE

14163 25,50€

0.50	5	50	-
Kg	Sub	11	11

VELCRO DISK FOR ITEM 53576

14330 3,50€

0.01	5	50	-
Kg	Sub	11	11

AIR TOOL REPAIR KIT

14154 42,00€

0.05	-	10	-
Kg	Sub	11	11

3" AIR POLISHER KIT

53646 62,00€

0.85	5	10	400
Kg	Sub	11	11

- Kit It includes:
- 1x 3" mini polisher.
- 1x Velcro sanding disc (installed).
- 1x wrench for nuts.
- 3x polishing sponges with Velcro backing.



120mm

3,200 RPM	90 PSI	3,5 CFM	6,3 bar	1/4"
99 L/min	3" x3	0,69kg		

SPONGE SOFT PAD FOR ITEM 53646

14286 2,99€

0.01	-	200	-
Kg	Sub	11	11

SPONGE HARD PAD FOR ITEM 53646

14287 2,99€

0.01	-	200	-
Kg	Sub	11	11

WOOL POLISHING PAD FOR ITEM 53646

14288 6,00€

0.01	10	200	-
Kg	Sub	11	11

VELCRO DISK FOR ITEM 53646

14289 6,10€

0.10	-	200	-
Kg	Sub	11	11

JBM RECOMMENDS THE USE OF ITS LUBRICANT OILS TO OPTIMIZE PERFORMANCE AND EXTEND LIFESPAN OF AIR TOOLS

14534 600ML

14560 100ML

VAT not included

HEADLIGHT RESTORATION KIT

53626 18,00€

0.30 - 12 576



This kit is intended to restore **2 headlights**.

Designed to restore clarity to headlight lenses that have become yellowed, cloudy or hazy. Headlight lens restoration kit improves the performance of the headlight. Three easy steps: sand, polish and protect. Car headlight restoration kit doesn't include household polishing machine. Restores headlights, taillights, fog lights or directional lights.

- Contents:
- 2 x P800 Sanding Discs
- 2 x P1200 Sanding Discs
- 2 x P2000 Sanding Discs
- 1 x 85gm Polish Paste
- 2 x 3.0ml UV Protect Liquid
- 1 x Masking tape
- 1 x Wool Polish Disc
- 1 x White Sponge Disc
- 1 x Backer Pad M10 Thread
- 2 x Adapter (3/8" & 1/4")



POLISHING KIT: 3" AIR POLISHER + 12 HEADLIGHTS RESTORATION KITS

SERIE262 199,00€

5.25 - - -



AIR TOOLS SET

52331 201,00€

7.90 - 2 48



AIR IMPACT WRENCH + AIR HUMMER + AIR RACHET + MINI AIR GRINDER + AIR GUN + STRAIGHT AIR GUN + ACCESSORIES



- 1 x Impact gun 1/2"
- 1 x 150mm air hammer
- 1 x Air ratchet 3/8"
- 1 x Pneumatic Polisher
- 1 x Dock retention
- 1 x Extension bar 1/2" - 75mm
- 1 x Mini oil
- 1 x 4mm hex. wrench
- 8 x Impact sockets: 12, 13, 17, 19, 1/2", 9/16", 5/8", 11/16"
- 1 x Blow gun
- 1 x Mini blow gun
- 1 x Teflon tape
- 4 x Scarps 120mm
- 2 x Spanners
- 5 x Sanding disc 1/4"

- 5 x Sanding disc 1/2"
- 5 x Grinding stones 1/4"
- 5 x Polishing stones 3/8"
- 2 x Sanding cylinders (3/4" and 1")
- 1 x Quick female adapter
- 1 x Connector escarpment
- 8 x Blowing lugs
- 2 x Necklaces 1/8"
- 1 x Quick connector M-M
- 1 x Quick connector M-H
- 1 x Rubber Mouthpiece
- 1 x Conical nozzle
- 1 x Inflation needle
- 1 x High pressure nozzle
- 1 x Safety nozzle
- 1 x Plastic box

KIT WITH AIR WRENCH AND RATCHET SET

52156 140,00€

5.36 - 4 112



IMPACT WRENCH:

1/2" MAX 312 Nm 7,000 RPM

2,6kg 1/4" 90 PSI 4 CFM

PNEUMATIC RATCHET: ADAPTER M / H

1/2" MAX 61 Nm 150 RPM

1,22kg 1/4" 90 PSI 4 CFM



1/2" **16 PCS**

9, 10, 11, 13, 14, 17, 19, 22, 24, 27mm

AIR IMPACT WRENCH 1/2"

52165 118,00€

2.90 - 6 168



610Nm

1/2" MAX 610 Nm 7,000 RPM

90 PSI 4 CFM



1/2" AIR RATCHET

52167 48,00€

1.25 - 5 10 560



61Nm

1/2" MAX 61 Nm 150 RPM

95 dBA 1/4" 141 L/min 90 PSI 6.3 bar 5 CFM



AIR NEEDLE SCALER

53625 68,00€

2.15 5 10 320



- Beat per minute: 4500BPM
- 19 needles
- Weight: 1,97kg

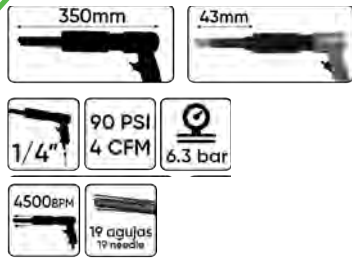

NEEDLE FOR REF. 53625

14188 0,50€

0.00 50 200 -



Stroke: 43mm

PNEUMATIC HAMMER CHISEL

52718 48,00€

1.95 4 8 144



9
PCS

REVERSIBLE AIR DRILL 1/2"

52159 64,00€

1.79 5 10 240



3/8" STRAIGHT AIR DRILL

53573 36,00€

0.75 5 20 -



- Suitable with 1,5-10mm drills.



REVERSIBLE AIR DRILL 3/8"

52160 48,00€

1.22 5 10 400



REVERSIBLE RIGHT ANGLE PNEUMATIC DRILL 3/8" 90°

52527 82,00€

1.22 5 10 480



16 PIECES AIR DIE GRINDER KIT

52157 48,00€

0.90 5 10 240



MINI AIR DIE GRINDER 1/4"

52171 39,00€

0.40 5 20 1080

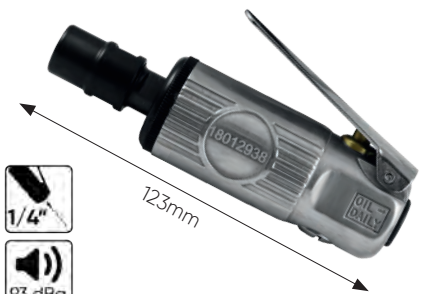

JBM RECOMMENDS THE USE OF ITS LUBRICANT OILS TO OPTIMIZE PERFORMANCE AND EXTEND LIFESPAN OF AIR TOOLS

ON PAGE 144

14534
600ML



14560
100ML



3" CUT-OFF TOOL

52953 38,00€

0.90 5 20 420

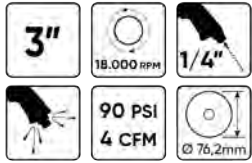

CUTTING DISC 3" FOR REF. 52953

12987 1,50€

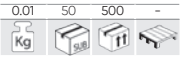

CUTTING DISCS

FOR REF. 51227



51387 3,25€



Ø Interior: 9,53mm
Ø Exterior: 75mm

3"

FOR REF. 51219



51385 4,55€



Ø Interior: 9,53mm
Ø Exterior: 100mm

4"x1/32"

SANDING DISCS

FOR REF. 51218

51386 5,95€



Ø Interior: 22mm
Ø Exterior: 125mm

5"



FOR REF. 51226

51444 5,05€



Ø Exterior: 2"

#80



FOR REF. 51226

51443 5,50€



Ø Exterior: 2"

#60



FOR REF. 51226

51445 5,05€



Ø Exterior: 2"

#120



AIR TOOL DISPLAY STAND

53492 380,00€



TOOLS NOT INCLUDED



MAGNETIC HOOKS FOR PNEUMATIC TOOLS

52378 10,00€



52378

51341 35,00€

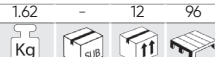

51341

PNEUMATIC TOOL DISPLAY STAND

53147 41,00€



TOOLS NOT INCLUDED



IN-LINE TYRE INFLATOR

ANALOGUE GAUGE

53449 14,00€

0.45	5	20	320
Kg	SUB	ff	ff

0-7 BAR
0-100 PSI



DIGITAL

53450 28,30€

0.40	5	20	320
Kg	SUB	ff	ff

0-14 BAR
0-200 PSI



- Batteries included.

DPF FILTER CLEANING KIT

52543 182,00€

0.84	-	6	90
Kg	SUB	ff	ff

- Universal.
- Maximum capacity 650cc.
- Nylon hose 4x6x2.7m.
- Work pressure range: 3 bar - 7 bar.
- Aluminum body long duration warranty.



DECARBONIZER

90003 35,20€

1.08	-	12	400
Kg	SUB	ff	ff



NEUTRALIZER

90004 25,80€

0.50	-	12	320
Kg	SUB	ff	ff



AIR BLOW GUN + GUN GRIP TYRE INFLATOR

51981 21,50€

0.58	5	20	240
Kg	SUB	ff	ff

0-16 BAR
0-220 PSI



GUN GRIP TYRE INFLATOR

51980 15,00€

0.40	5	25	450
Kg	SUB	ff	ff

0-16 BAR
0-220 PSI



TIRE PRESSURE GAUGE

52648 9,00€

0.08	5	100	2000
Kg	SUB	ff	ff

5-6 bar



WITH HOSE

53416 14,10€

0.20	10	100	800
Kg	SUB	ff	ff

0-10 bar



DIGITAL WITH HOSE

53417 26,30€

0.25	10	100	800
Kg	SUB	ff	ff

0-15 BAR
0-200 PSI

0-1.500 KPA



DIGITAL TIRE GAUGE

53418 16,90€

0.20	10	100	800
Kg	SUB	ff	ff

0-15 BAR
0-300 PSI

0-1.500 KPA



PNEUMATIC GREASE GUN

50751 43,00€

1.50	5	10	150
Kg	SUB	ff	ff

- Pressure: 30Mpa.



500ml

JBM RECOMMENDS THE USE OF ITS LUBRICANT OILS TO OPTIMIZE PERFORMANCE AND EXTEND LIFESPAN OF AIR TOOLS

ON PAGE 144

14534
600ML



14560
100ML



NEUMATIC TOOLS 5 PCS SET

51277 64,00€

1.84 - 5 60



- Gun for gravity painting of 600ml tank.
- Hose 5x8mm spiral with 1/4" rapid connection extensible upto 4,5m.
- Air gun.
- Spray gun with cleaning solution tank.
- Pneumatic inflator with pressure manometer.
- Spray gun with cleaning solution tank.



AIR BLOW GUN

51383 11,10€

0.27 10 50 650



- Air gun.
- Rapid European connection.
- Hose connection.
- 10cm tube extender.
- 20cm tube extender.



IN 10 UNITS DISPLAY CASE



EXTENDABLE LONG LANCE AIR BLOW GUN

52798 18,00€

0.25 10 50 700



285-530mm



RUBBERIZED TIP TO AVOID SCRATCHES

LONG AIR BLOW GUN

52490 6,65€

0.10 10 40 960



100mm

52491 10,50€

0.15 10 80 800



300mm



IN 10 UNITS DISPLAY CASE

EXTRA LONG AIR BLOW GUN

53611 27,50€

0.50 - 40 160



1.020MM

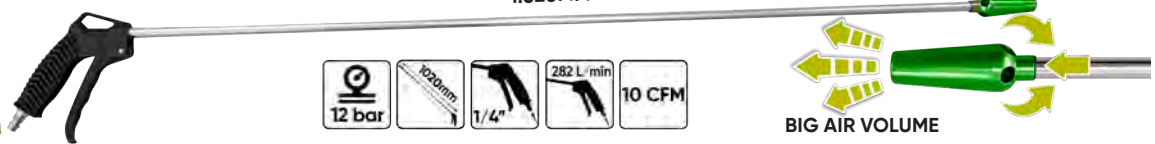

BIG AIR VOLUME

AIR BLOW GUN

53205 19,00€

0.90 - 48 500



- Air blow gun with big air volume nozzle.
- Body material: Aluminum-alloy.
- Surface: Nickel-plating.



BIG AIR VOLUME

AIR BLOW GUN IN INDIVIDUAL BLISTER

52787 9,00€

0.20 25 100 1000



AIR BLOW GUN 3/8" WITH RECOIL HOSE 5m

52381 20,50€

0.45 5 25 200



OIL FILTER AND REGULATOR

53063 36,70€

0.60 5 50 300



1/4"

53064 37,40€

0.63 5 50 300



3/8"

53065 36,90€

0.60 5 50 300



1/2"



AIR FILTER, REGULATOR & OIL LUBRICATOR

53066 61,00€

1.08 5 25 250



1/4"

53067 61,00€

0.50 5 25 250



3/8"

53068 63,00€

1.00 5 25 250



1/2"



1/4" OIL COUPLER

14561 8,80€

0.05 25 50 -



1/4"



AIR TOOL OIL

14534 16,50€

0.55 - 12 540



- Relative density at 15°C: 0.845.
- Viscosity: 12,1 cSt at 40°C.
- Color: Colorless.

600ml



14560 8,80€

0.10 12 72 1008



100ml



AIR SPRAY GUN

54248 58,00€

0.63	5	20	240
Kg	sub	ft	ft

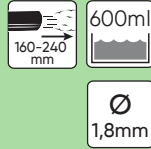

PROFESSIONAL AIR SPRAY GUN

54249 103,00€

0.71	5	20	240
Kg	sub	ft	ft

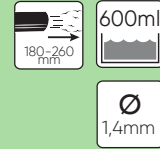

AIR DRYING GUN

53606 55,00€

0.60	5	20	-
Kg	sub	ft	ft



CE



AIR SAND BLASTER GUN

53593 41,00€

2.75	-	5	80
Kg	sub	ft	ft

- It includes:
1x Air sand blasting gun.
1x Blasting catcher.
2x Blasting sand bottles.
4x Caps:

Point blasting cap.
Surface blasting cap.
Blasting cap for outside corners.
Blasting cap for inside corners.

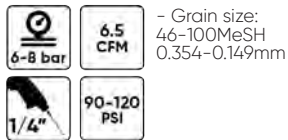

- Grain size:
46-100MeSH
0.354-0.149mm

- Ideal for many applications in the car body area and all metallic surfaces: allows to remove rust, excessive dirt, coatings, etc. easily.



SAND FOR REF.
53593

14168	7,00€		
0.95	-	20	-
Kg	sub	ft	ft



ENGINE WASHING GUN

53202 15,70€

1.40	-	10	80
Kg	sub	ft	ft

- Engine cleaning gun.
- Pot material: Steel.
- Body material: Aluminum-alloy.
- Body surface: Powder painting.



TORNADOR CLEANING GUN

53204 81,00€

0.90	-	5	60
Kg	sub	ft	ft



- Car cleaning gun.
- Pot material: PE.
- Body material: Aluminum-alloy.
- Body surface: Polished.



AIR BLOW STAND WITH 2 DRYING GUNS

53607 292,00€

7.35	-	2	36
Kg	sub	ft	ft



360° Air dryer gun rotates 360° and locks in any position.

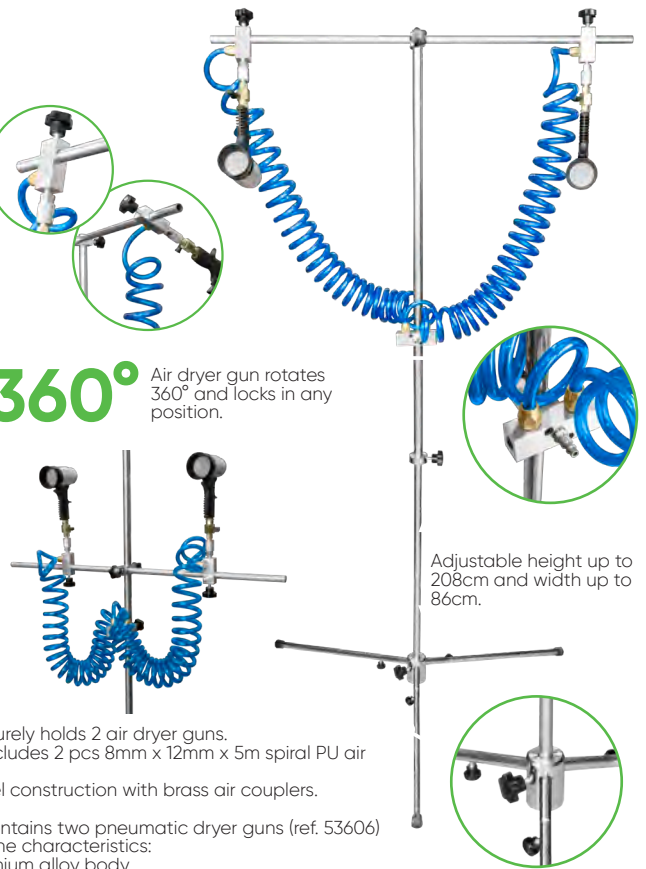

- Securely holds 2 air dryer guns.
- It includes 2 pcs 8mm x 12mm x 5m spiral PU air hose.
- Steel construction with brass air couplers.
- It contains two pneumatic dryer guns (ref. 53606) with the characteristics:
Aluminium alloy body.
Working pressure: 2-4 bar (30-60psi).
Air consumption: 325 l/min.
Inlet size: 1/4".
With air regulator valve.

3/8" AIR HOSE REEL 20+2m

53582 179,00€

10.85	-	1	14
Kg	SUB	ff	ff

53583 170,00€

10.75	-	1	14
Kg	SUB	ff	ff

20 m + 2 m

300 PSI
20 BAR

3/8"

Ø 9,5 mm

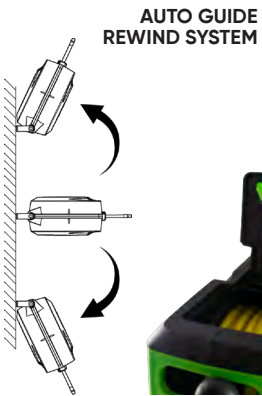

**WALL
BRACKET
INCLUDED**

WALL MOUNT

14772 8,50€

0.35	-	20	-
Kg	SUB	ff	ff

3/8" AIR HOSE REEL 12+1m

53532 119,00€

6.80	-	2	30
Kg	SUB	ff	ff

53581 115,00€

6.70	-	2	30
Kg	SUB	ff	ff

12 m + 1 m

300 PSI
20 BAR

3/8"

Ø 9,5 mm

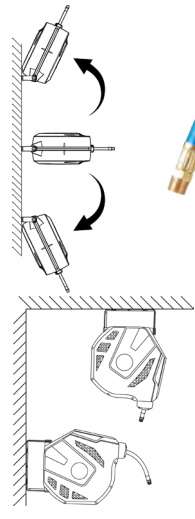

**WALL
BRACKET
INCLUDED**

WALL MOUNT

14771 10,50€

0.35	-	30	-
Kg	SUB	ff	ff

AIR HOSE REEL 11m

53881 79,00€

4.50	-	4	48
Kg	SUB	ff	ff

53882 79,00€

4.50	-	4	48
Kg	SUB	ff	ff

10 m + 1,5 m

150 PSI
10 BAR

1/4" PVC

Ø 12 mm

Ø 8 mm



**WALL
BRACKET
INCLUDED**

**AUTO GUIDE
REWIND SYSTEM**

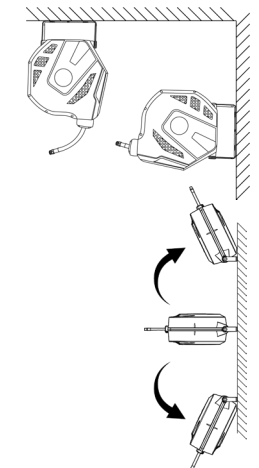

RECOIL AIR HOSE

53629	14,30€	10m	53630	18,80€	15m
0.55 - 6 372	8mm	connector 1/4"	0.65 - 6 240	8mm	connector 1/4"
53632	46,00€	15m	53631	33,50€	15m
2.20 - 6 78	15mm	connector 1/4"	1.25 - 6 132	12mm	connector 1/4"
53634	63,00€	15m	53633	46,00€	15m
2.60 - 6 66	18mm	connector 1/2"	2.10 - 6 78	15mm	connector 3/8"

WITH 360 DEGREE SWIVEL ENDS FOR EASY MOVEMENT AND EASE OF USE

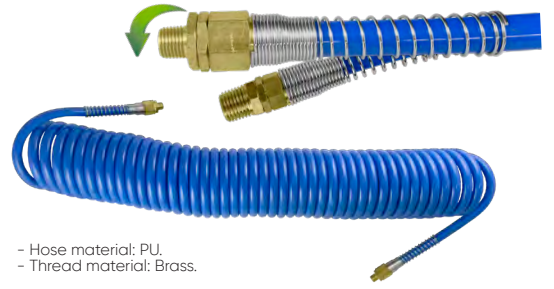

- Hose material: PU.
- Thread material: Brass.

AIR LINE HOSE

53594	54,00€	3.10 - 4 96	53595	61,00€	3.20 - 4 96
--------------	--------	-------------	--------------	--------	-------------



- Work pressure: 300PSI / 20bar.
- Breakage pressure: 950PSI / 65bar.
- Work temperature: -40°C / 65°C
- Great flexibility.
- Return to its original form.
- Smooth surface, does not damage paint.
- Very resistant.

53594

Inside diameter: 8mm
External diameter: 13mm
To use with:
Ref. 52736 M8

53595

Inside diameter: 10mm
External diameter: 15mm
To use with:
Ref. 52737 M10

25m 300 PSI 20 BAR

HYBROD POLYMER

x10

SET OF 10 CLAMPS 8-16mm

14169 3,00€

0.10 - 125 -

SECURITY LOCK QUICK CONNECTOR HOSE CONNECTION

14201	4,00€	0.10 25 100 -	M6
14202	4,00€	0.10 25 100 -	M8
14203	4,50€	0.10 25 100 -	M10

SWIVEL MALE AIR PLUG

14314	5,00€	0.06 25 100 -	EUR 1/4"
14315	4,50€	0.06 25 100 -	US 1/4"

QUICK RELEASE AIR FITTINGS MALE THREADED

REF.	DESCRIPTION	Kg	€
14204	EUR - M6	0,06	1,50€
14205	EUR - M8	0,06	1,50€
14206	EUR - M10	0,06	1,50€
14207	US - M6	0,06	1,50€
14208	US - M8	0,06	1,50€
14209	US - M10	0,06	1,50€

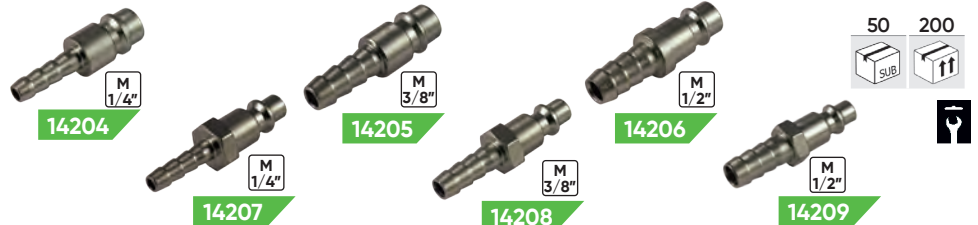

SECURITY LOCK QUICK CONNECTOR

REF.	DESCRIPTION	Kg	€
14195	FEMALE - 1/4" MALE THREAD	0,5 25 100	4,00€
14196	FEMALE - 3/8" MALE THREAD	0,10 25 100	4,00€
14197	FEMALE - 1/2" MALE THREAD	0,10 25 100	4,50€
14198	FEMALE - 1/4" FEMALE THREAD	0,10 25 100	4,00€
14199	FEMALE - 3/8" FEMALE THREAD	0,10 25 100	4,00€
14200	FEMALE - 1/2" FEMALE THREAD	0,10 25 100	4,50€

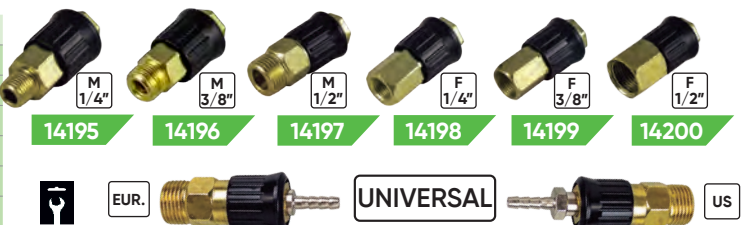

CONNECTOR / THREAD

REF.	DESCRIPTION	Kg	€
US			
13930	MALE QUICK CONNECTOR - 1/4" MALE THREAD	0,05	1,50€
13932	MALE QUICK CONNECTOR - 3/8" MALE THREAD	0,1	2,50€
14076	MALE QUICK CONNECTOR - 3/8" FEMALE THREAD	0,1	1,50€
13933	MALE QUICK CONNECTOR - 1/2" MALE THREAD	0,1	2,00€
13935	MALE QUICK CONNECTOR - 1/4" FEMALE THREAD	0,05	2,50€
13936	FEMALE QUICK CONNECTOR - 1/4" FEMALE THREAD	0,05	3,50€
13937	FEMALE QUICK CONNECTOR - 1/4" MALE THREAD	0,05	4,00€
14078	FEMALE QUICK CONNECTOR - 3/8" FEMALE THREAD	0,1	4,00€
14191	MALE QUICK CONNECTOR - 1/2" FEMALE THREAD	0,1	2,00€
14193	FEMALE QUICK CONNECTOR - 1/2" FEMALE THREAD	0,1	4,00€
EUR.			
13931	MALE QUICK CONNECTOR - 1/4" MALE THREAD	0,05	2,50€
14075	MALE QUICK CONNECTOR - 3/8" FEMALE THREAD	0,1	2,00€
13934	MALE QUICK CONNECTOR - 1/4" FEMALE THREAD	0,05	2,50€
13938	FEMALE QUICK CONNECTOR - 1/4" FEMALE THREAD	0,1	3,50€
13939	FEMALE QUICK CONNECTOR - 1/4" MALE THREAD	0,1	4,00€
14077	FEMALE QUICK CONNECTOR - 3/8" FEMALE THREAD	0,1	4,50€
14190	MALE QUICK CONNECTOR - 1/2" FEMALE THREAD	0,1	2,00€
14192	FEMALE QUICK CONNECTOR - 1/2" FEMALE THREAD	0,1	4,00€

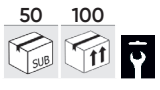

QUICK RELEASE COUPLING

52735 4,85€				52736 5,35€				52737 5,50€			
0.05	25	200	4000	0.10	25	200	4000	0.10	25	200	4000
M6				M8				M10			



SWIVEL AIR HOSE CONNECTOR

12988 12,00€				13809 18,50€				13810 20,50€			
0.15	62	125	-	0.10	62	250	-	0.10	62	250	-
1/2"				1/4"				3/8"			





IMPACT TOOLS

- 150 IMPACT TOOL SETS
- 152 EXTENSION BARS
- 153 BIT SETS
- 154 IMPACT ADAPTORS
- 156 IMPACT SOCKETS

6 PIECE 1/2" HEX IMPACT TOOL SET

52337 65,00€

1.91 5 10 300
Kg SUB IT

1/2" 6 PCS

CONTAIN

x3 30, 32, 36mm
80mmL
x3 14, 17, 19mm
43mmL



8 PIECE 1/2" XZN IMPACT SOCKET + BITS SET

52547 96,00€

2.70 - 5 200
Kg SUB IT

1/2" 8 PCS

CONTAIN

x4 27, 30, 32, 34, 36mm
x3 M14, M16, M18
43mmL



13 PIECE 1/2" HEX IMPACT SOCKET + ADAPTER SET

52341 58,00€

1.70 - 4 336
Kg SUB IT

1/2" 13 PCS

10, 11, 12, 13, 14, 17, 19, 21, 22, 24mm

SPARE PARTS AVAILABLE

REF.	mm	Kg	SUB	IT	€	REF.	mm	Kg	SUB	IT	€	REF.	mm	Kg	SUB	IT	€	
14728	10mm	0,10	5	20	3,80€	11195	17mm	0,10	10	50	3,70€	14735	Impact bit holder	0,05	5	20	6,50€	
14729	11mm	0,05	5	20	3,80€	11121	19mm	0,10	10	60	4,10€	12074	125mm imp. extension bar	0,23	10	60	11,50€	
14730	12mm	0,05	5	20	3,80€	14733	21mm	0,10	5	20	4,30€	11990	Univ. joint impact socket	0,15	100	100	15,30€	
14731	13mm	0,10	5	20	3,80€	14734	22mm	0,15	5	20	5,40€							
14732	14mm	0,10	5	20	3,80€	11122	24mm	0,15	10	20	5,45€							



3 PIECE 1/2" XZN IMPACT SOCKET

52694 49,00€

1.31 5 10 600
Kg SUB IT

1/2" 3 PCS

30, 32, 36mm (78mmL)



19 PIECE 1/2" IMPACT SOCKETS HEXAGONAL + ADAPTER SET

52345 109,00€

3.55 - 6 240
Kg SUB IT



53531 109,00€

3.55 - 4 240
Kg SUB IT



1/2" 19 PCS

52345: SPARE PARTS AVAILABLE

REF.	mm	Kg	SUB	IT	€	REF.	mm	Kg	SUB	IT	€
14728	10mm	0,10	5	20	3,80€	14733	21mm	0,10	5	20	4,30€
14729	11mm	0,05	5	20	3,80€	14734	22mm	0,15	5	20	5,40€
14730	12mm	0,05	5	20	3,80€	11122	24mm	0,15	10	20	5,45€
14731	13mm	0,10	5	20	3,80€	11123	27mm	0,35	10	50	6,50€
14732	14mm	0,10	5	20	3,80€	12937	50mm impact extension bar	0,11	10	100	9,50€
14970	15mm	0,08	5	20	2,50€	14973	150mm impact extension bar	-	5	20	11,50€
14971	16mm	0,07	5	20	2,50€	12075	250mm impact extension bar	0,45	10	50	15,50€
11195	17mm	0,10	10	50	3,70€	11962	Impact adapter 1/2"H 3/4"M	0,15	10	100	7,50€
14972	18mm	0,12	5	20	3,50€	11990	Universal joint impact socket	0,15	10	100	15,30€
11121	19mm	0,10	10	60	4,10€						



15 PIECE 1/2" HEX DEEP IMPACT SOCKETS SET

52346 103,00€

4.55 - 6 252
Kg SUB IT

1/2" 15 PCS

SPARE PARTS AVAILABLE

REF.	mm	Kg	SUB	IT	€	REF.	mm	Kg	SUB	IT	€
12071	24mm	0,30	10	50	11,00€	12061	10mm	0,14	10	100	9,50€
12072	27mm	0,35	10	20	12,00€	12062	12mm	0,15	10	100	9,50€
12074	125mm impact extension bar	0,23	10	60	11,50€	12063	13mm	0,15	10	50	9,50€
12075	250mm impact extension bar	0,45	10	50	15,50€	12064	15mm	0,17	10	100	9,00€
11990	Universal joint impact socket	0,15	10	100	15,30€	12065	16mm	0,30	10	20	9,00€
						12066	17mm	0,20	10	50	9,00€
						12067	18mm	0,20	10	20	9,50€
						12068	19mm	0,21	10	50	9,50€
						12069	21mm	0,25	10	50	9,50€
						12070	22mm	0,30	10	20	10,50€



12 PCS LOW PROFILE HEXAGONAL IMPACT SOCKET SET 1/2"

53060 34,90€

0,85 5 25 500

Kg SUB ff

10, 11, 12, 13, 14, 15, 16, 17, 18, 19, 20, 21mm (28,2mmL)

1/2" 12 PCS

28mmL

11 PCS 1/2" IMPACT SOCKET SET

53744 63,00€

2,30 5 10 360

Kg SUB ff

52342 63,00€

2,05 5 10 360

Kg SUB ff

10, 11, 12, 13, 14, 16, 17, 19, 21, 22, 24mm (78mmL)

1/2" 11 PCS



SPARE PARTS AVAILABLE

REF.	mm	Kg	SUB	ff	€
12061	10mm	0,14	10	100	9,50€
14736	11mm	0,15	5	20	5,00€
12062	12mm	0,15	10	100	9,50€
12063	13mm	0,15	10	50	9,50€
14737	14mm	0,15	5	20	5,00€
12065	16mm	0,30	10	20	9,00€
12066	17mm	0,20	10	50	9,00€
12068	19mm	0,21	10	50	9,50€
12069	21mm	0,25	10	50	9,50€

REF.	mm	Kg	SUB	ff	€
12070	22mm	0,30	10	20	10,50€
12071	24mm	0,30	10	50	11,00€

3 PIECE HEX. LONG IMPACT SOCKET SET

52969 20,70€

0,80 5 20 640

Kg SUB ff

17, 19, 21mm (78mmL)

1/2" 3 PCS

SPARE PARTS AVAILABLE

REF.	mm	Kg	SUB	ff	€
12066	17mm	0,18	10	50	9,00€
12068	19mm	0,21	10	50	9,50€
12069	21mm	0,20	10	50	9,50€

4 PIECE 1/2" DRIVE ALLOY WHEEL IMPACT SOCKET SET

53587 44,00€

1,05 5 20 -

Kg SUB ff

15mm SMART
17mm MERCEDES
21mm HYUNDAI KIA
22mm OPEL

85mmL

1/2" 4 PCS

SPARE PARTS AVAILABLE

REF.	mm	Kg	SUB	ff	€
14172	15mm - SMART	0,20	10	50	8,50€
14173	17mm - MERCEDES	0,20	10	50	9,50€
14177	22mm - OPEL	0,25	10	50	9,50€
14178	21mm - HYUNDAI/KIA	0,25	10	50	9,50€

4 PIECE SET OF 1/2" DRIVE FOR ALLOY WHEELS

52338 41,00€

1,00 5 20 640

Kg SUB ff

17, 19, 21, 22mm (85mmL)

1/2" 4 PCS

SPARE PARTS AVAILABLE

REF.	mm	Kg	SUB	ff	€
11314	17mm	0,21	10	100	8,50€
11315	19mm	0,23	10	100	8,50€
11316	21mm	0,26	10	100	8,50€
11628	22mm	0,27	10	50	9,50€

3 PIECE DRIVE ALLOY WHEEL IMPACT SOCKET SET

51336 29,30€

0,85 - 5 700

Kg SUB ff

17, 19, 21mm (85mmL)

1/2" 3 PCS

VAT not included

10 PIECE SET OF 1/2" IMPACT SOCKET

53988 101,00€

3.00	-	10	120
Kg	Sub	ff	



CONTAIN

x7 1/2"	15, 17, 19, 21, 22, 23, 24mm
x1 7/8"	Tesla
x1 17mm	Mercedes
x1 21mm	Hyundai/Kia



12 PIECE 1/2" HEX. IMPACT SOCKET & WHEEL NUT REMOVER SET

52343 52,00€

1.90	-	4	360
Kg	Sub	ff	

CONTAIN

x3 85mmL	17, 19, 21mm
x1 42mmL	27mm
x8 38mmL	10, 11, 13, 14, 17, 19, 22, 24mm



4 PCS ANTI-TWISTING WHEEL LUG IMPACT SOCKET SET

53197 46,00€

1.17	5	20	-
Kg	Sub	ff	



17, 19, 21, 22mm (82mmL)

DRIVE TORQUE LIMITING EXTENSION BAR SET

53077 62,00€

1.58	-	10	240
Kg	Sub	ff	

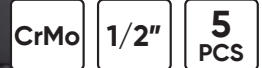

100, 110, 120, 135, 150 Nm

TORQUE LIMITING EXTENSION BARS

<p>200NM</p> <p>13680 15,50€</p> <p>0.36 - 50 -</p> <p>Kg Sub ff</p>	<p>175NM</p> <p>13682 15,50€</p> <p>0.32 - 50 -</p> <p>Kg Sub ff</p>	<p>150NM</p> <p>13684 15,50€</p> <p>0.28 - 50 -</p> <p>Kg Sub ff</p>	<p>160NM</p> <p>13683 15,50€</p> <p>0.30 - 50 -</p> <p>Kg Sub ff</p>	<p>135NM</p> <p>13685 15,50€</p> <p>0.25 5 50 1500</p> <p>Kg Sub ff</p>	<p>110NM</p> <p>13687 15,50€</p> <p>0.22 5 50 -</p> <p>Kg Sub ff</p>	<p>90NM</p> <p>13689 15,30€</p> <p>0.20 5 50 1500</p> <p>Kg Sub ff</p>
--	--	--	--	---	--	--

DRIVE IMPACT EXTENSION BAR

12937 9,50€

0.11	10	100	1500
Kg	Sub	ff	

50mm



12074 11,50€

0.23	10	60	-
Kg	Sub	ff	

125mm



12075 15,50€

0.45	10	50	-
Kg	Sub	ff	

250mm



1/2"

UNIVERSAL JOINT IMPACT SOCKET 3/4" - 1/2"

11938 47,00€

0.62	6	30	-
Kg	Sub	ff	

3/4"



11990 15,30€

0.15	10	100	100
Kg	Sub	ff	

1/2"

11938 11990

3 PCS UNIVERSAL JOINT IMPACT SOCKET WITH DOUBLE POSITION (FIXED/ARTICULATED)

53043 53,00€

0.43	5	50	1000
Kg	Sub	ff	

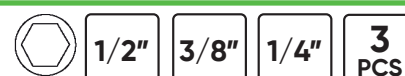

8-PCS IMPACT SOCKET WITH DOUBLE POSITION (FIXED/ARTICULATED)

53044 121,00€

2,43 - 8 1000



1/2"

8
PCS

13, 14, 15, 16, 17, 19, 21, 22mm

6 PIECE 1/2" XZN IMPACT SOCKET + BITS SET

52546 39,60€

0,80 5 10 720



1/2"

6
PCS

REF.	mm	Kg	Sub	11	€
12931	43mmL	0,08			7,50€
12932	43mmL	0,08			7,50€
12933	43mmL	0,08			8,00€
12934	78mmL	0,08			7,50€
12935	78mmL	0,08			8,00€
12936	78mmL	0,08			8,50€



BIT SOCKET XZN TAMPERPROOF

52810 9,00€

0,20 5 100 -



M16



1/2"

75mm



- Impact sockets 75mm long, squared 1/2" to extract the drain screw with impact wrench in transmissions of VAG, Porsche, Ford, etc.

52811 9,90€

0,15 5 100 -



M18

- To extract the vehicle steering arm of VAG vehicles.



13 PCS SET OF 1/2" IMPACT BITS HEX. AND TORX

52344 197,00€

1,45 - 10 600



1/2"

13
PCS

CONTAIN

	x5 45mmL	5, 6, 8, 10, 12mm
	x8 45mmL	T30, T40, T45, T50, T55, T60, T70, T80

8 PCS SET OF 1/2" HEX. IMPACT SOCKET BITS

52339 61,00€

1,25 5 10 360



SPARE PARTS AVAILABLE

REF.	mm	Kg	Sub	11	€
14004	5mm	0,1	10	240	9,50€
14005	6mm	0,1	10	120	10,50€
14006	7mm	0,1	10	240	9,50€
14007	8mm	0,2	10	240	9,50€
14008	10mm	0,1	10	240	9,50€
14009	12mm	0,1	10	240	9,50€
14010	14mm	0,1	10	120	11,00€
14011	17mm	0,2	10	60	11,00€



1/2"

8
PCS

5, 6, 7, 8, 10, 12, 14, 17mm (78mmL)

8 PCS SET OF 1/2" TORX IMPACT SOCKET BITS

52340 58,00€

1,15 5 10 360



SPARE PARTS AVAILABLE

REF.	mm	Kg	Sub	11	€
12938	T25	0,08	10	50	10,00€
12939	T30	0,09	10	50	10,00€
12940	T40	0,09	10	50	10,00€
12941	T45	0,09	10	50	10,00€
12942	T50	0,09	10	60	10,00€
12943	T55	0,1	10	50	10,00€
12944	T60	0,12	10	50	10,00€
12945	T70	0,14	10	20	10,50€



1/2"

8
PCS

T25, T30, T40, T45, T50, T55, T60, T70 (78mmL)

VAT not included



www.jbmcamp.com

153

6PCS IMPACT ADAPTOR SET

53743 39,70€

0.80	5	20	960



6
PCS

M	F
3/4"	1/2"
1/2"	3/4"
3/8"	1/4"
1/4"	3/8"
1/2"	3/8"
3/8"	1/2"



SPARE PARTS AVAILABLE

REF.	mm	Kg	Box	Tray	€
14749	1/4" F - 3/8" M	-	20	100	2,00€
14750	3/8" M - 1/4" F	-	20	100	2,00€
14751	3/8" M - 1/2" F	-	20	100	4,00€
14752	1/2" F - 3/8" M	-	10	100	4,00€

2 PCS 1"-1/2" IMPACT ADAPTOR

52545 177,00€

3.00	1	4	1500



1" 1/2" F - 1" M
1" F - 1" 1/2" M

8 PIECE SET OF 3/4" DEEP IMPACT SOCKETS

53470 176,00€

7.50	-	1	85



3/4" 8
PCS

24, 27, 29, 30, 32, 34, 36, 38mm (90mmL)



6 PCS IMPACT ADAPTOR

52544 93,00€

2.90	-	4	384

6
PCS 1" 3/4" 1/2"

CONTAIN

1/2" x2	H x 1" M (50mmL), H x 3/4" M (48mmL)
3/4" x2	H x 1" M (63mmL), H x 1/2" M (85mmL)
1" x2	H x 3/4" M (69mmL), H x 1/2" M (70mmL)



SPARE PARTS AVAILABLE

REF.	mm	Kg	Box	Tray	€
11962	1/2" H - 3/4" M	0,16	10	100	7,50€
11963	1/2" H - 1" M	0,26	6	54	9,00€
11964	3/4" H - 1/2" M	0,34	6	36	12,50€
11965	3/4" H - 1" M	0,44	6	48	16,00€
11966	1" H - 1/2" M	0,53	6	36	18,00€
11967	1" H - 3/4" M	0,53	4	36	18,00€



8 PCS SET OF 3/4" LONG IMPACT SOCKETS

52347 158,00€

6.25	-	4	200



3/4" 8
PCS

26, 27, 29, 30, 32, 35, 36, 38mm (90mmL)



16 PCS BITS SOCKET 3/4"

51028 163,00€

6.25	-	2	-

3/4" 16
PCS

CONTAIN

	3/4" x4	E18, E20, E22, E24
	3/4" x5	T60, T70, T80, T90, T100
	3/4" x4	H17, H19, H22, H24
	x2 1" - 3/4"	x1 4mm



8 PCS SET OF 1" IMPACT SOCKETS

52348 179,00€

5.85	-	2	252



1" 8
PCS

24, 27, 30, 32, 33, 36, 38, 41mm



SPARE PARTS AVAILABLE

REF.	mm	Kg	Box	Tray	€
13859	24mm	0,6	6	96	16,00€
13874	27mm	0,6	6	72	17,50€
13875	30mm	0,5	6	18	18,50€
13876	32mm	0,6	6	24	18,50€
13877	33mm	0,6	6	96	18,50€
11153	36mm	0,7	6	18	23,40€
11155	38mm	0,9	6	12	24,40€
11158	41mm	0,95	6	18	28,50€



SPARE PARTS AVAILABLE

REF.	mm	Kg	Box	Tray	€
14723	H17	0,35	-	10	18,00€
14724	T60	0,30	-	10	18,50€
14725	T70	0,30	-	10	18,50€
14726	T80	0,30	-	10	17,50€



IMPACT SOCKETS



REF.	mm	Kg	Sub	11	€
11153	36mm	0,71	6	18	23,40€
11154	37mm	0,73	6	24	21,70€
11155	38mm	0,74	6	12	24,40€
11156	39mm	0,74	6	24	28,90€
11157	40mm	0,78	6	12	26,60€
11158	41mm	0,81	6	18	28,50€
11159	42mm	0,91	6	18	30,30€
11160	43mm	0,94	6	12	27,00€
11161	44mm	0,93	6	18	32,30€
11162	45mm	0,94	4	8	29,10€
11163	46mm	1,00	4	12	32,70€
11164	47mm	1,02	4	8	30,70€
11165	48mm	1,01	4	8	34,60€
11166	50mm	1,18	4	12	30,90€
11167	51mm	1,18	4	8	38,00€
11168	52mm	1,18	1	10	41,00€
11169	53mm	1,27	4	12	39,20€
11170	54mm	1,33	4	12	40,00€
11171	55mm	1,44	2	8	51,00€
11172	56mm	1,47	4	8	48,00€
11173	57mm	1,44	4	8	47,00€
11174	58mm	1,58	4	8	47,00€
11175	59mm	1,58	4	8	49,00€
11176	60mm	1,62	2	4	56,00€
11177	62mm	1,63	2	4	55,00€
11178	63mm	1,75	-	8	53,00€
11179	65mm	1,87	2	8	65,00€
11180	67mm	1,93	2	8	59,00€
11181	68mm	1,93	2	8	65,00€
11182	70mm	2,09	2	4	73,00€
11183	71mm	3,10	-	6	70,00€
11184	73mm	3,27	-	4	87,00€
11185	75mm	3,34	1	6	97,00€
11186	76mm	3,70	-	5	91,00€
11187	78mm	3,47	-	5	98,00€
11188	80mm	3,69	1	4	103,00€
11189	85mm	3,81	1	4	121,00€
11190	89mm	3,80	-	2	138,00€
11191	90mm	4,29	1	4	149,00€
11192	92mm	4,50	1	2	152,00€
11193	95mm	4,89	-	2	183,00€
11194	100mm	4,36	1	4	176,00€
11621	105mm	7,81	1	2	359,00€
11622	110mm	7,75	1	2	399,00€
11623	115mm	8,21	1	2	489,00€



REF.	mm	Kg	Sub	11	€
14728	10mm	0,10	5	20	3,80€
14729	11mm	0,05	5	20	3,80€
14730	12mm	0,05	5	20	3,80€
14731	13mm	0,10	5	20	3,80€
14732	14mm	0,10	5	20	3,80€
11195	17mm	0,10	10	50	3,70€
11121	19mm	0,10	10	60	4,10€
14733	21mm	0,10	5	20	4,30€
14734	22mm	0,15	5	20	5,40€
11122	24mm	0,14	10	20	5,45€
11123	27mm	0,17	10	50	6,50€
11124	30mm	0,20	10	50	7,65€
11125	32mm	0,22	10	50	8,50€



REF.	mm	Kg	Sub	11	€
11126	19mm	0,25	6	60	11,20€
11127	21mm	0,29	6	24	13,80€
11128	22mm	0,34	6	24	14,10€
11129	24mm	0,32	6	54	14,10€
11130	25mm	0,33	6	24	13,10€
11131	26mm	0,32	6	36	14,10€
11132	27mm	0,35	6	54	13,70€
11133	28mm	0,40	6	12	12,00€
11134	30mm	0,41	6	24	15,00€
11135	32mm	0,44	6	48	17,20€
11136	33mm	0,47	6	12	15,30€
11137	34mm	0,51	6	24	18,20€
11138	35mm	0,49	6	12	18,00€
11139	36mm	0,52	6	24	18,80€
11140	38mm	0,53	6	24	20,40€
11141	40mm	0,54	6	12	18,60€
11142	41mm	0,61	6	12	21,30€
11143	46mm	0,74	6	18	26,40€
11144	50mm	1,00	6	24	33,30€
11145	51mm	1,10	4	12	35,30€
11146	55mm	1,23	4	12	37,30€
11147	57mm	1,23	4	12	41,00€
11148	60mm	1,40	4	12	47,00€
11149	63mm	1,32	4	12	45,00€
11150	65mm	1,50	1	8	55,00€
11151	67mm	1,49	4	12	57,00€
11152	70mm	1,49	4	12	57,00€



REF.	mm	Kg	Sub	11	€
11624	65mm	2,42	1	2	189,00€
11625	85mm	5,11	1	2	282,00€
12984	105mm	4,8	1	2	379,00€

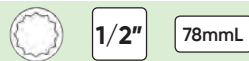

REF.	mm	Kg	Sub	11	€
14738	10mm	-	10	100	5,50€
14739	11mm	-	10	100	5,50€
14740	12mm	-	10	100	5,55€
14741	13mm	-	10	100	5,55€
14742	14mm	-	10	100	5,55€
14743	16mm	-	10	100	5,15€
14744	17mm	-	10	50	5,35€
14745	19mm	-	10	50	6,25€
14746	21mm	-	10	50	6,40€
14747	22mm	-	10	50	7,10€
14748	24mm	-	10	50	8,30€
11613	27mm	0,34	10	20	11,00€
11614	30mm	0,42	10	40	13,00€
11615	32mm	0,38	6	24	14,20€
11616	33mm	0,45	6	12	18,10€
11617	34mm	0,40	6	24	18,70€
11618	35mm	0,46	6	18	18,80€
11619	36mm	0,47	6	36	19,50€

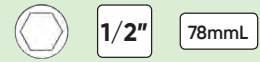

REF.	mm	Kg	Sub	11	€
12061	10mm	0,14	10	100	9,50€
14736	11mm	0,15	5	20	5,00€
12062	12mm	0,15	10	100	9,50€
12063	13mm	0,13	10	50	9,50€
14737	14mm	0,15	5	20	5,00€
12064	15mm	0,17	10	100	9,00€
12065	16mm	0,16	10	20	9,00€
12066	17mm	0,18	10	50	9,00€
12067	18mm	0,23	10	20	9,50€
12068	19mm	0,21	10	50	9,50€
12069	21mm	0,24	10	50	9,50€
12070	22mm	0,28	10	20	10,50€
12071	24mm	0,30	10	50	11,00€
12072	27mm	0,35	10	20	12,00€

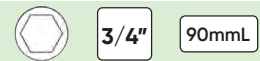

REF.	mm	Kg	Sub	11	€
13723	19mm	0,41	6	12	18,50€
13724	21mm	0,48	6	12	19,20€
13725	22mm	0,61	6	18	19,20€
13726	24mm	0,56	6	24	19,00€
13727	26mm	0,51	6	18	18,70€
13728	27mm	0,50	6	18	18,50€
13729	29mm	0,71	6	12	22,00€
13730	30mm	0,68	6	24	22,00€
13731	32mm	0,71	6	24	21,60€
13732	33mm	0,78	5	15	23,80€
13733	34mm	0,81	6	18	24,90€
13734	35mm	0,80	6	18	25,70€
13735	36mm	0,81	6	12	25,80€
13736	38mm	0,83	6	18	25,90€

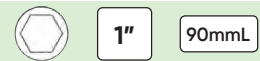

REF.	mm	Kg	Sub	11	€
13745	28mm	0,77	6	24	25,20€
13746	30mm	0,95	6	12	25,40€
13747	32mm	0,90	6	12	25,40€
13748	33mm	0,89	6	12	24,90€



BPW REAR HUBCAP NUT SOCKET

52914 223,00€

- BPW rear axis bush extraction.

2.90 - 4 500



120mm 8 FACES
HEXAGONAL SQUARE 41mm



BPW REAR HUBCAP NUT SOCKET

52915 199,00€

- BPW rear axis bush extraction.

2.90 - 8 1500



111mm OVAL
HEXAGONAL SQUARE 41mm



BPW REAR HUBCAP NUT SOCKET

52916 218,00€

- BPW rear axis bush extraction.

2.57 - 6 1000



109mm 8 FACES
HEXAGONAL SQUARE 41mm



BPW ROLLER AXLE NUT SOCKET

52917 122,00€

- 6,5-9 CAB bush extraction.

1.05 - 10 1000



65mm OVAL
HEXAGONAL SQUARE 36mm



REAR SHAFT HUBCAPS SOCKET BPW

52918 146,00€

- BPW rear axis extraction.

2.05 - 8 1500



95mm 3/4" SQUARE



WHEEL NUT SOCKET BPW

52919 181,00€

- BPW rear axis extraction.

2.65 - 8 1500



110mm 8 FACES
3/4" SQUARE



BPW ROLLER BEARINGS AXLE NUT SOCKET

52920 155,00€

- To extract the BPW axis bearing nut 12 TON.

1.35 - 10 1000



80mm 3/4" SQUARE



BPW ROLLER BEARINGS AXLE NUT SOCKET

52921 117,00€

- To extract the BPW axis bearing nut 6,5-9 TON.

0.73 - 10 500



65mm 3/4" SQUARE



BPW ROLLER BEARINGS AXLE NUT SOCKET

52922 180,00€

- BPW axis.

2.10 - 10 1000



85mm 6 FACES
3/4" SQUARE



SCANIA FRONT WHEEL SHOCK ABSORBER SPRING WASHER SOCKET

52923 59,00€

0.55 - 12 1500



28x37mm 3/4" SQUARE



SCANIA DAMPER ROD SOCKET FOR REAR AXLES

52924 52,00€

0.75	-	24	1500
Kg	Sub	ff	ff

34x46mm

3/4" SQUARE



SCANIA FRONT WHEEL NUT SOCKET

52925 176,00€

1.80	-	10	1500
Kg	Sub	ff	ff

80mm

8 FACES

HEXAGONAL SQUARE 41mm

- Front wheel nut extraction.



SCANIA REAR WHEEL NUT SOCKET

52926 201,00€

2.75	-	8	1500
Kg	Sub	ff	ff

100mm

8 FACES

3/4" SQUARE

- Rear wheel nut extraction.



SCANIA REAR WHEEL SHOCK ABSORBER SPRING WASHER SOCKET

52927 59,00€

0.78	-	20	1000
Kg	Sub	ff	ff

34x56mm

3/4" SQUARE



SCANIA FRONT WHEEL NUT SOCKET

52928 172,00€

1.90	-	10	1500
Kg	Sub	ff	ff

80mm

8 FACES

3/4" SQUARE

- Front wheel nut extraction.



SCANIA 10 WHEELS CAB THIRD AXLE NUT SOCKET

52929 185,00€

2.68	-	6	1500
Kg	Sub	ff	ff

95mm

8 FACES

3/4" SQUARE

- Third bush nut extraction in 10 axes trucks.



SCANIA CRANKSHAFT REAR OIL SEAL INSTALLER

52930 117,00€

2.86	-	4	1500
Kg	Sub	ff	ff

SCANIA 310/320

OIL SEAL 0366303-R



SCANIA CAMSHAFT ROTATOR

52931 45,00€

0.23	-	10	500
Kg	Sub	ff	ff

1/2" SQUARE



SCANIA ELEC ROMAGNETIC INJECTION VALVE CAP SOCKET

52932 45,00€

0.47	-	20	1500
Kg	Sub	ff	ff

Ø 38mm

1/2" SQUARE



GROOVE NUT SOCKET

52933 194,00€

3.15	-	6	504
Kg	Sub	ff	ff

SCANIA 420

8 MERLONS

3/4" SQUARE

Ø Exterior: 11,6cm

Ø Interior: 10cm



IVECO AXLE NUT SOCKET

53430 286,00€

- Used with 36mm socket or wrench.

2,95 - 8 280
Kg SUB ff

Ø Exterior: 134mm
Ø Interior: 110,5mm
IVECO
12 FACES
118x134mm



BENZ / MAN CLAMP NUT SOCKET

52935 94,00€

0,91 - 10 1000
Kg SUB ff

60mm 3/4" SQUARE



BENZ & MAN REAR AXLE NUT SOCKET

52936 199,00€

- Useful in van trucks.

1,58 - 10 1500
Kg SUB ff

80-95mm 6 MERLONS
3/4" SQUARE

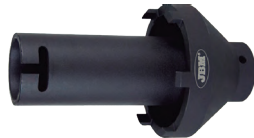

BENZ & MAN REAR AXLE NUT SOCKET

52937 265,00€

- Rear axis bush extraction.

3,05 - 6 1500
Kg SUB ff

95-115mm 6 MERLONS
3/4" SQUARE



MAN / BENZ DRIVE AXLE NUT SOCKET

52938 199,00€

- To extract the steering shaft nut.

3,22 - 6 1500
Kg SUB ff

100mm 6 MERLONS
3/4" SQUARE



MAN/BENZ TRUCK DIES EL INJECTION VALVE SOCKET

52939 28,00€

0,20 - 30 1500
Kg SUB ff

22-28mm 4 MERLONS
3/4" SQUARE
DIESEL



MAN/BENZ DIFFERENTIAL REAR NUT SOCKET

52940 235,00€

4,34 - 4 1500
Kg SUB ff

101mm 6 MERLONS
3/4" SQUARE



ENGINE CRANK ALIGNMENT (2 GEARS)

52941 70,00€

- For Benz de 6, 8 and 10 cylindres.
- For Man 12 cylindres.

0,54 - 20 1500
Kg SUB ff

1/2" SQUARE



ENGINE CRANK ALIGNMENT (3 GEARS)

52942 105,00€

- For Mercedes Actros and Atego.
- For Man 5,6 and 8 cylindres.

0,87 - 20 960
Kg SUB ff

1/2" SQUARE



FLYWHEEL ROTATING TOOL WITH ONE SPROCKET (1 GEAR)

52943 75,00€

0,49 - 30 1500
Kg SUB ff

1/2" SQUARE



BALL JOINT-PULLER BELL VIBRO-IMPACT (WITH WINDOW)

52944 110,00€

1,00 - 20 1500
Kg SUB ff

30mm
HEXAGONAL SQUARE 19mm



BALL JOINT-PULLER BELL VIBRO-IMPACT

52945 281,00€

2,74 - 24 960
Kg SUB ff

39mm
HEXAGONAL SQUARE 26mm



BENZ / MAN CLAMP NUT SOCKET

52934 102,00€

1,05 - 12 1000
Kg SUB ff

56mm
3/4" SQUARE





CAR BODY REPAIR

- 160 SHEET METAL WORK TOOLS
- 161 CAR HEADLIGHT
- 162 WELDING / PRY BARS
- 163 LOCK-OUT TOOL SETS
- 164 CLAMPS
- 166 CAULKING GUNS
- 167 SUBJECTION TAPES WITH TENSIONER
- 168 STANDS
- 170 CAR MAINTENANCE / DISPLAYERS
- 171 PADS
- 172 ALUMINIUM LADDERS AND PLATFORMS

PDR DENT REPAIR TOOL KIT

53224 142,00€

32
PCS

AUDI

3,90	-	5	35
Kg	sub	ff	

- 1pc glue gun(220-240V~, 50Hz, 40W).
- 1pc sliding hammer to pull out hard dents.
- 1pc dent lifter (Baby face mini lifter or normal mini lifter) for slight dents on flat surface.
- 1pc glue remover.
- 1pc scraper for gentle removal of dent pads.
- 8pcs black glue sticks (11 x 200mm) with very good performance for best results.
- 19pcs glue tabs in various sizes and shapes.



SPARE PARTS AVAILABLE

REF.	DESCRIPTION	Kg	sub	ff	€
13842	Bag of 5 pcs blue pad	0,15	10	100	8,50€
13843	Bag of 4 pcs yellow pad	0,1	10	100	7,00€
13844	Bag of 10 pcs red pad	0,3	10	50	9,00€
13845	Bag of 5 glue bar	0,02	10	100	8,00€



13842



13843



13844



13845

DENT MIRROR

53486 29,30€

0,30	10	40	160
Kg	sub	ff	

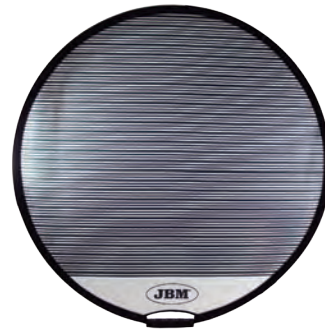
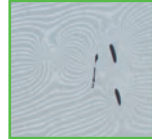

Ø 800mm

LETTERS AND NUMBERS

They allow numerical or alphabetical marking of all types of metal surfaces by pressing or tapping. The rounded finish of its end avoids the appearance of cracks or breaks in the worked surface.

LETTERS AND NUMBERS

52422 24,70€

0,82	3	6	540
Kg	sub	ff	



5mm A-Z & 0-9

LETTERS AND NUMBERS

53119 52,00€

194	3	6	504	36 PCS	5/16"
Kg	sub	ff			



8mm A-Z & 0-9

NUMBERS

52882 14,00€

0,30	10	60	1500	1/4"	9 PCS
Kg	sub	ff			



6mm 0-8

7 PIECE RUBBERISED DOLLY SET DOLLY SET

52876 182,00€

3,13	-	6	84
Kg	sub	ff	



PLASTIC COATED



12959



12955



12956



12957



12958

7
PCS



12960



12961

SPARE PARTS AVAILABLE

REF.	DESCRIPTION	Kg	sub	ff	€
12955	Flat face & oval face tas	0,29	-	25 99	27,80€
12956	Rail tas	0,31	-	25 99	27,80€
12957	Oval face tas	0,37	5	25 99	27,80€
12958	Handle with wedge tas	0,41	-	25 -	27,80€
12959	Tas in comma	0,3	5	25 99	27,80€
12960	Tas heeled	0,18	-	25 1.500	27,80€
12961	Tas in comma with wedge	0,34	-	25 -	27,80€

HEADLIGHT RESTORATION SET

53673 80,00€

2,00	-	10	80
Kg	sub	ff	ff

- The liquid polymer headlamp refurbishment kit is an innovative system for restoring sunburnt headlamps to their original condition, with the original gloss and a perfect finish in a very fast and economical way.

- Includes:
- 600ml liquid bottle
- 6 pcs abrasive paper
- Textured paper
- Plastic funnel
- Curved cap with rubber seal ring
- Flat cap with one rubber seal ring
- Ac-dc adapter
- 12V adapter
- Evaporating cup
- Grinding plate



14568 15375 14564 14566 14567 14573 14565 14569 14570 14571

15375 28,00€

0,80	4	24	600
Kg	sub	ff	ff

BOTTLE WITH LIQUID 600ml

The liquid polymer headlamp refurbishment kit is an innovative system for restoring sunburnt headlamps to their original condition, with the original gloss and a perfect finish.



ORIGINAL GLOSS AND A PERFECT FINISH

SPARE PARTS AVAILABLE

REF.	DESCRIPTION	Kg	sub	ff	€	REF.	DESCRIPTION	Kg	sub	ff	€	REF.	DESCRIPTION	Kg	sub	ff	€
14564	6 Pcs abrasive paper	0,10	10	100	9,20€	14568	Curved cap with rubber seal ring	0,1	10	200	9,20€	14571	Grinding plate	0,05	-	100	9,20€
14565	Ac-dc adapter	0,20	10	50	26,70€	14569	Flat cap with one rubber seal ring	0,1	10	200	9,20€	14573	Textured paper	0,70	10	100	4,05€
14566	12V adapter	0,05	10	100	16,70€	14570	Funnel	0,01	10	200	4,05€	15375	600ml bottle with liquid	0,01	4	24	28,00€
14567	Evaporating cup	0,15	10	20	38,00€												



BAG OF 10 ABRASIVE PAPER

GRAIN	REF.	DESCRIPTION	Kg	sub	ff	€
GRAIN 180	14710		0,25			3,50€
GRAIN 280	14711		0,20			3,75€
GRAIN 360	14712		0,20			4,00€
GRAIN 600	14713		0,15			4,25€
GRAIN 800	14714		0,15			4,50€
GRAIN 1200	14715		0,10			4,75€

PANEL BEATING SET

51131 61,00€

5,00	-	5	100
Kg	sub	ff	ff



11544 11541 11542 11543 11547 11545 11546



7 PCS

SPARE PARTS AVAILABLE

REF.	DESCRIPTION	Kg	sub	ff	€	REF.	DESCRIPTION	Kg	sub	ff	€
11541	Bumping hammer	0,43	5	25	11,00€	11544	Utility dolly	0,69	5	25	7,00€
11542	Reverse curve hammer	0,38	5	25	11,00€	11545	Shrinking dolly	0,79	5	25	11,00€
11543	Pick and finish hammer	0,42	5	25	11,00€	11546	Double end dolly	0,81	5	25	12,00€
						11547	Curve dolly	0,81	5	25	12,00€

HEADLIGHT RESTORATION SET

53626 18,00€

0,30	-	12	576
Kg	sub	ff	ff

- Designed to restore clarity to headlight lenses that have become yellowed, cloudy, or hazy.
 - Headlight lens restoration kit improves the performance of the headlight.
 - Three easy steps: sand, polish and protect.
 - Car headlight restoration kit doesn't include household polishing machine.
 - Restores headlights, taillights, fog lights or directional lights.
 - This kit is intended to restore 2 headlights.



- Contents:
 2 x P800 Sanding Discs
 2 x P1200 Sanding Discs
 2 x P2000 Sanding Discs
 1 x 85gm Polish Paste
 2 x 3.0ml UV Protect Liquid
 1 x Masking tape
 1 x Wool Polish Disc
 1 x White Sponge Disc
 1 x Backer Pad M10 Thread
 2 x Adapter (3/8" & 1/4")



IN 12 UNITS DISPLAY CASE

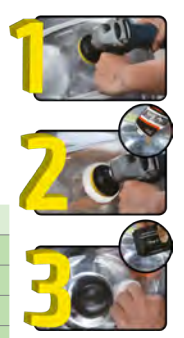

SPARE PARTS AVAILABLE

REF.	DESCRIPTION	Kg	sub	ff	€
14286	Sponge soft pad	1,95	-	200	2,99€
14287	Sponge hard pad	2,30	-	200	2,99€
14288	Wool pad	2,30	10	200	6,00€
14289	Velcro disk	7,40	-	200	6,10€
53646	3" Air polisher kit	8,95	5	10	62,00€

POLISHING KIT: 3" AIR POLISHER + 12 HEADLIGHTS RESTORATION KITS

SERIE262 199,00€



53626 x1 53646 x12

VAT not included

WELDING MASK WITH GRIND PROTECTION

53414 49,00€

0.85	-	6	36
Kg	Sub	ft	ft



ANALOGIC REGULATOR TO ADJUST SENSITIVITY AND DARKENING

WELDING MASK WITH DIGITAL REGULATOR

53415 188,00€

0.95	-	4	40
Kg	Sub	ft	ft



AUTO DIMMING

DIGITAL REGULATOR TO ADJUST SENSITIVITY, DARKENING AND CADENCE

4PCS PRY BAR SET EXTRALONG

52977 137,00€

8.50	-	1	42
Kg	Sub	ft	ft

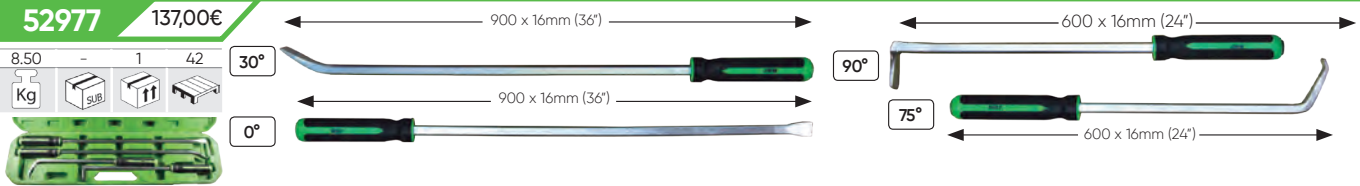

27 NYLON PRY BARS SET

52788 39,00€

1.18	27	10	170
Kg	Sub	ft	ft

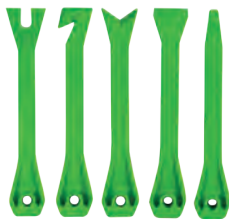

27 PCS

- Set levers 27 with different curvatures and endings that facilitate the work both indoors and outdoors of vehicles. Its wide range allows you to use the right tool for each job and piece, allowing access to difficult places.

5 NYLON PRY BARS SET

50901 16,00€

0.30	5	20	240
Kg	Sub	ft	ft



- Universal
- Three special width
- One with puller

- Sizes:
6 x 160mm
30 x 200mm
20 x 180mm
20 x 215mm



4 NYLON PRY BAR SET

51832 18,00€

0.50	12	24	192
Kg	Sub	ft	ft

19x273, 22x273,
25x273, 38x273mm

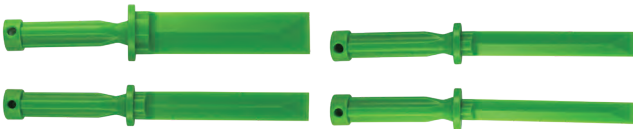

5 PCS METAL PRY BARS SET

50903 30,80€

1.90	4	8	200
Kg	Sub	ft	ft

60, 43, 38,
28, 18cm

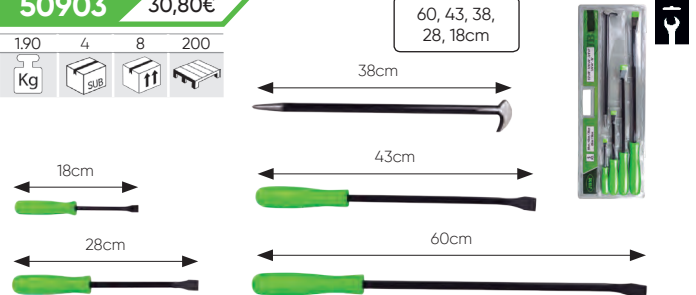

SET OF 2 METAL LARGE PRY BARS

52026 31,80€

2.04	5	10	240
Kg	Sub	ft	ft

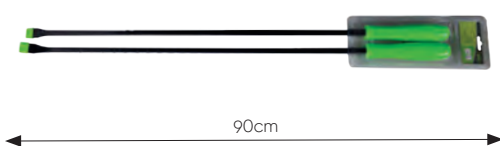

WRECKING BAR

51360 8,05€

0.80	5	20	900
Kg	Sub	ft	ft

18" x 5/8

51361 9,80€

1.46	5	10	500
Kg	Sub	ft	ft

24" x 3/4

MADE OF STEEL



2 NYLON PRY BAR SET

52851 9,65€

0,35	6	60	600
Kg	Sub	ff	ff



6 PCS PRY BARS SET

53110 27,30€

1,42	6	12	168
Kg	Sub	ff	ff

5"x8.5 / 5"x10.3
5"x4.5 / 15"x8.5
15"x10.3 / 15"x4.5mm

6 PCS



LOCK-OUT TOOL SET

53230 19,70€

0,65	6	24	288
Kg	Sub	ff	ff

UNIVERSAL **8 PCS**

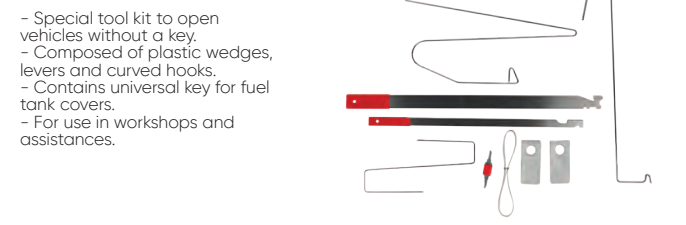

- Special tool kit to open vehicles without a key.
- Composed of plastic wedges, levers and curved hooks.
- Contains universal key for fuel tank covers.
- For use in workshops and assistances.

4 PCS INFLATABLE PAD SET

52077 29,50€

40-50mm

0,35	5	40	400
Kg	Sub	ff	ff



- It contents: 16 x 16cm Pad, 32 x 12cm Pad, 19 x 6cm Pad, 18 x 4.5cm Pad, Manual pump
- By inserting them between the glass and the door frame, they allow the vehicle to be opened easily and without damaging it.
- Max. pressure supported: 100kg.

FOR REF. 53232

WIRE FOR WINDSHIELD REMOVAL

13813 7,00€

0,10	10	60	1200
Kg	Sub	ff	ff

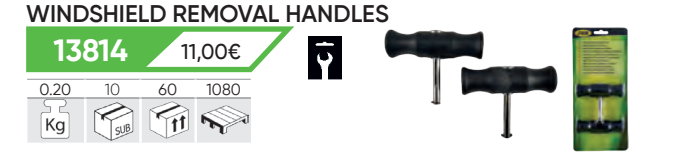

WINDSHIELD REMOVAL HANDLES

13814 11,00€

0,20	10	60	1080
Kg	Sub	ff	ff



WINDSHIELD REMOVAL TOOL SET

53232 39,00€

1,15	-	10	180
Kg	Sub	ff	ff



- Content: 1x Windshield removal tool, 1x Windshield molding release tool, 1x Trim pad remover, 1x 1.8m wire, 2x Wire gripping handle, 1x Wire feeder tool.

MAGNETIC SQUARE 45°, 90°, 135°

54111 4,75€

0,35	10	40	1680
Kg	Sub	ff	ff

75mm

54113 7,65€

0,60	10	20	1100
Kg	Sub	ff	ff

100mm



53545

35,70€

0,74	5	20	600
Kg	Sub	ff	ff

8, 10, 12, 13, 14mm

Cr-V BMW, FORD, OPEL, VAG, VAUXHALL

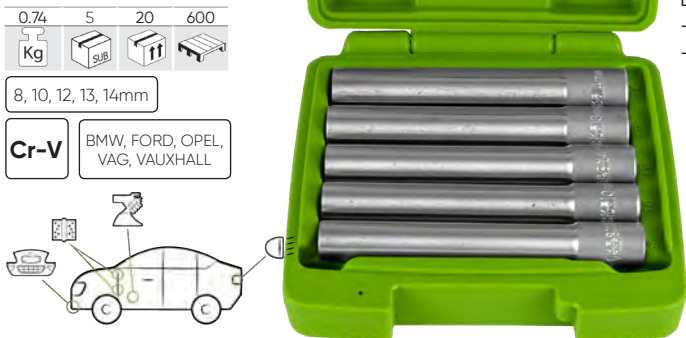

- It allows to adjust the parking breake cable in BMW, FORD OPEL, VAG and VAUXHALL.
- Useful for door hinges, bumpers and rear lights.
- It is also used for hand brakes.



VAT not included

EXTRA-WIDE OPENING LOCKING PLIERS

0,90	10	20	300
Kg	sub	ff	ff

STRAIGHT

53675 0,75 Kg
50,00€

CURVE

53676 0,85 Kg
44,00€

SWIVEL PAD

53677 0,90 Kg
55,00€

LONG-CURVE

53678 1,090 Kg
52,00€

10"

REF	←	→
53675	250mm	70mm
53676	250mm	90mm
53677	250mm	80mm
53678	300mm	105mm



IN 10 UNITS
DISPLAY CASE

3 EXTRA-LONG LOCKING JAW PLIERS

52982 53,00€

1,60	4	8	384
Kg	sub	ff	ff

37cm: right angle
36cm: 45° angle
34cm: 90° angle

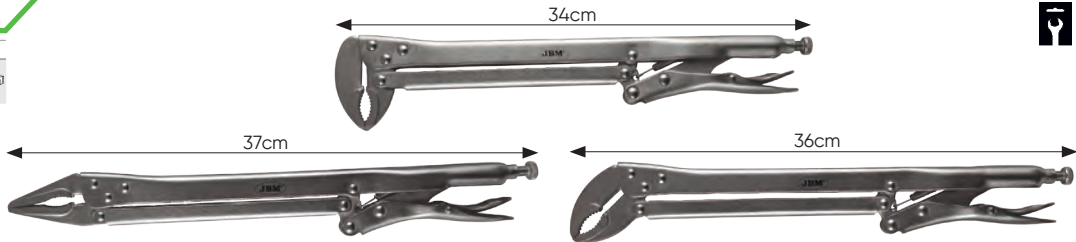

CURVED JAW LOCKING PLIER

50577 12,60€

0,53	5	40	-
Kg	sub	ff	ff

CrV 280mm



PARROT NOSE GRIP WRENCH

52386 23,60€

0,44	10	50	1500
Kg	sub	ff	ff

52386
FLAT



52387
WITH SAWTEETH



52387 24,50€

0,44	10	50	1000
Kg	sub	ff	ff

CrMo

215mm

- Heavy duty jaws lock on to 3 sides of a hex fastener and will not slip or mar.

SELF LOCKING MULTI GRIP PLIER SET

52385 251,00€

3,72	-	6	120
Kg	sub	ff	ff



W CLAMP: 195mm

14103 32,40€



T Type: 215mm

14104 32,40€



STRAIGHT JAWS: 225mm

14105 32,40€



J CLAMP: 210mm

14106 32,40€



LL CLAMP: 195mm

14107 32,40€



JJ CLAMP: 195mm

14108 32,40€



6" LOCKING C-CLAMP

52505 20,80€

0,27	36	72	2160
Kg	sub	ff	ff

White box



170mm

CrMo

0-40mm



6" LOCKING C-CLAMP WITH PAD

52506 16,00€

0,28	36	72	2160
Kg	sub	ff	ff

White box



170mm

CrV

0-50mm



18" LOCKING C-CLAMP WITH PAD

52512 50,00€

1,31	-	20	280
Kg	sub	ff	ff

White box



440mm

CrMo

0-210mm



8" LOCKING C-CLAMP

52511 42,00€ 440mm

1.31 - 20 280

Kg SUB 11 11

CrMo

0-225mm

- Presentation in box



SHEET METAL CLAMP

52507 30,10€ 250mm

0.77 5 30 420

Kg SUB 11 11

CrMo

0-80mm

- Presentation in box



9" WELDING CLAMP

52504 27,60€ 225mm

1.14 - 30 480

Kg SUB 11 11

CrMo

0-60mm

- Presentation in box



11" LOCKING C-CLAMP WITH PAD

52503 32,50€ 280mm

0.85 10 30 540

Kg SUB 11 11

CrMo

0-105mm



PLUGWELD PLIERS

52390 35,20€ 250mm

0.50 5 40 640

Kg SUB 11 11

CrMo



11" LOCKING C-CLAMP

52502 31,40€ 280mm

0.84 10 30 540

Kg SUB 11 11

CrMo

0-110mm



GAP HOOKS CLAMP

52477 70,00€ 2T

2.65 - 6 1500

Kg SUB 11 11

0-60mm



5T 90° ANGLE PULL CLAMP

52478 49,00€ 5T

2.90 - 10 1500

Kg SUB 11 11

0-20mm



90° 3T C CLAMP

52479 24,70€ 3T

1.18 - 30 1500

Kg SUB 11 11

0-20mm



RING CLAMP

52474 68,00€ 6T

3.49 - 5 1500

Kg SUB 11 11

0-20mm



LONG NOSE CLAMP

52475 62,00€ 3T

3.60 - 10 1500

Kg SUB 11 11

0-25mm



HEAVY DUTY CLAMP

52476 50,00€ 5T

3.10 - 10 1500

Kg SUB 11 11

0-25mm



3T BOX CLAMP WITH PULL BRACKET

52480 44,00€ 3T

2.00 - 10 1500

Kg SUB 11 11

0-25mm



BOX CLAMP 3T

52481 52,00€ 3T

2.05 - 9 1500

Kg SUB 11 11

0-20mm

Width 4x1,5mm



SMALL MOUTH PULL CLAMP TWO-WAY

52482 44,00€ 5T

2.13 - 8 1500

Kg SUB 11 11

0-10mm



5T SMALL MOUTH PULL CLAMP SINGLE WAY

52483 41,00€ 3T

2.02 - 12 1500

Kg SUB 11 11

0-10mm



PULL CLAMP

52487 63,00€ 5T

2.27 - 7 1000

Kg SUB 11 11

0-20mm



3T DOUBLE CLAW HOOK

52484 66,00€ 3T

1.19 - 11 1500

Kg SUB 11 11

0-110mm



4T CHAIN JOINT (DOUBLE GRAB HOOK ASSEMBLY)

52485 51,00€ 4T

1.17 - 30 1000

Kg SUB 11 11

0-90mm



3T CHAIN JOINT (CLAW HOOK & GRAB HOOK ASSEMBLY)

52486 62,00€ 3T

1.21 - 11 1500

Kg SUB 11 11

0-110mm



CAULKING GUN

52533 10,00€

0.74	12	24	144
Kg	Sub	ff	ff



9"

300ml



PNEUMATIC CAULKING GUN

53567 43,00€

1.05	-	10	180
Kg	Sub	ff	ff

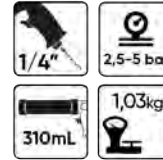

- Working pressure: 2,5-5 BAR.
- Air inlet: 1/4 "
- Cartridge capacity: 310ml.

310ml



SILICONE CAULKING TOOL

54017 12,00€

4.60	5	20	240
Kg	Sub	ff	ff



This set help you repair the gap and clean the residual glue, Improve the quality and the estetic

- The stainless steel scraper remove old glue
- The silicone trowel remove surface bumps and dents
- It's a good tool for smoothing sealing lines, caulking lines; Finish to most silicone jobs, any edge, corner, joint



It includes 5 replaceable Silicone Pads (3R,6R,10R,13R,17R radius)

3R

6R

10R

13R

17R



This tool can be used use for home, kitchen, bathroom, windows and so on.

SET OF 2 MINI SUCTION PAD

52295 6,50€

0.15	10	100	1200
Kg	Sub	ff	ff

5KG

Ø 60mm



SUCTION PAD WITH HANDLE

52589 13,00€

0.28	10	40	640
Kg	Sub	ff	ff



8KG

Ø 70mm

SUCTION PAD

UNITARY

52262 7,50€

0.31	12	48	384
Kg	Sub	ff	ff

40KG

Ø 115mm



DOUBLE

52263 13,50€

0.59	6	24	192
Kg	Sub	ff	ff

70KG

Ø 115mm



TRIPLE

52264 18,60€

0.92	6	10	100
Kg	Sub	ff	ff

100 KG

Ø 115mm



QUADRUPLE

52265 30,50€

1.24	-	10	100
Kg	Sub	ff	ff

120 KG

Ø 115mm



DOUBLE SUCTION PAD ARTICULATED

52765 21,70€

0.72	5	20	80
Kg	Sub	ff	ff

100 KG

Ø 115mm

- Intended for maintenance, installation and removal of parts of the vehicle, both sheet metal and glass.
- Easy handling and conforms to the curvature of the surface potential.



SUCTION LIFTER SET

52998 48,00€

2.03	-	8	112
Kg	Sub	ff	ff

80 KG

Ø 120mm



5m x 25mm

SUBJECTION TAPE WITH TENSIONER

52321	8,80€	52327	12,00€
0,35 Kg	5 SUB	20 ff	1200 ff
5m x 25mm		0,46 Kg	5 SUB
		20 ff	1000 ff
		8m x 25mm	



PARTS CARRIER - WINDSHIELD AND HOOD

53983	215,00€	- Available for windscreens, sheet metalls, hoods, doors,...etc.	
19,40 Kg	-	1 SUB	35 ff

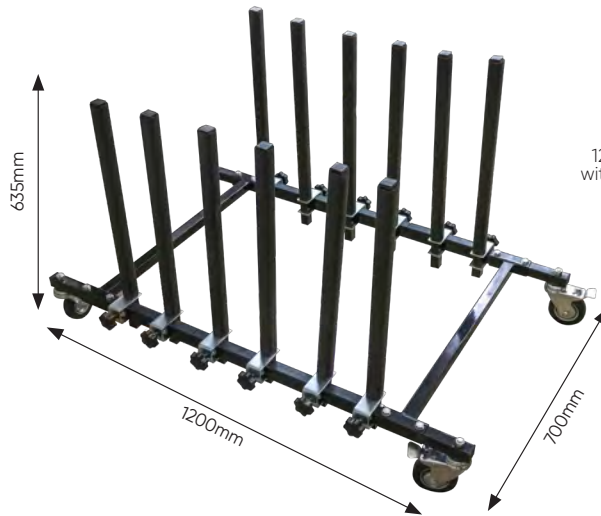

12pcs 630mm bar with EPE foam cover

Extensive up 5 large panels or glass

4 x 4inch PU Castors (Two Swivel With Brake)



AUTOMOTIVE PARTS CART

53125	477,00€	1,800mm	895mm	585mm
51,00 Kg	-	1 SUB	12 ff	

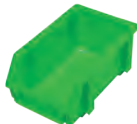
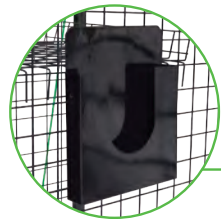

4x INCLUDED

UNIVERSAL TELESCOPIC STAND

53124	287,00€	21,10 Kg	-	1 SUB	11 ff
--------------	---------	-------------	---	----------	----------



HEIGHT SIZE
↑ 1.320mm
↓ 840mm

LENGHT SIZE
↑ 1.380mm
↓ 225mm

SPECIAL PLATE TRANSPORT CART

50923	454,00€	480mm	1300mm	800mm
36,40 Kg	-	1 SUB	18 ff	

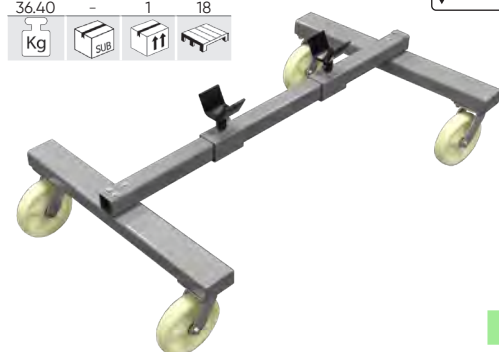

- Separation: 0 to 110cm.

WHEELS FOR REF. 50923

12022	33,70€
--------------	--------



PORTABLE WINDS-HELD STAND

53080 99,00€

1,130mm 990mm

7.87 Kg 1 SUB 1 ff 28

FOLDABLE SIZE

70 KG

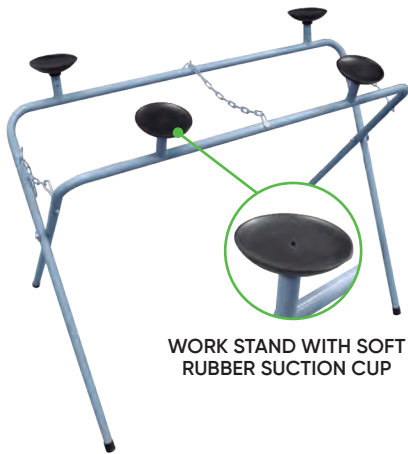

WORK STAND WITH SOFT RUBBER SUCTION CUP

PORTABLE WORKING FOLDING STAND

52749 79,00€

80mm 58mm

6.25 Kg 1 SUB 1 ff 31

220 KG



ACC. FOAM FOR REF. 52749

11959 10,50€ 0.08 Kg 100 ff

X-TRESTLE

53079 89,00€

6.77 Kg 1 SUB 1 ff 44

100 KG

UNFOLDED SIZE

660mm

600mm

870mm

FOLDED SIZE

1140mm

600mm

300mm

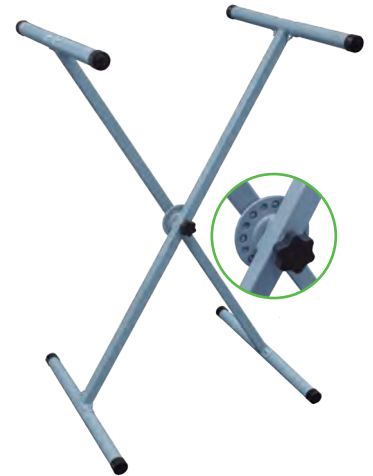

FOLDING BUMPER STAND

53736 98,00€

8.10 Kg 1 SUB 1 ff 44

- Ideal for supporting bumpers during the preparation and spraying.
- Adjustable stand: 75 cm -160cm.
- Maximum height: 148cm .



ADJUSTABLE STAND WIDTH WITH EXTENDABLE ARMS MAKES THIS UNIT SUITABLE FOR HOLDING VARIOUS TYPES AND STYLES OF BUMPERS



STEEL WITH POWDER COATED

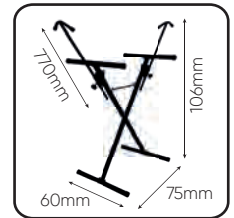

53685 310,00€

14.50 Kg 1 SUB 1 ff 14

1,110mm 760mm 1,340mm

- Holds any plastic bumper cover without touching the painted surface
- Makes repairs and painting faster and easier
- Cover can be rotated 90 degrees to ensure a proper paint coverage
- Five locking positions
- Four industrial-grade, total lock caster wheels for stability.

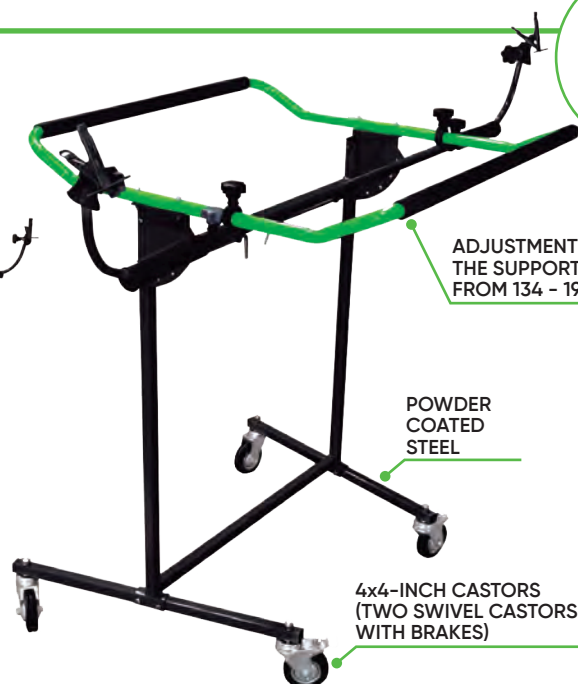

ADJUSTMENT OF THE SUPPORT ARMS FROM 134 - 198cm

POWDER COATED STEEL

4x4-INCH CASTORS (TWO SWIVEL CASTORS WITH BRAKES)

ADJUSTABLE PAINT HANGER

53134 144,00€

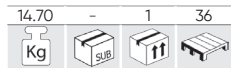

- 6 hooks to hold parts for painting or drying.
- Adjustable frame that extends from 127cm to 203cm.

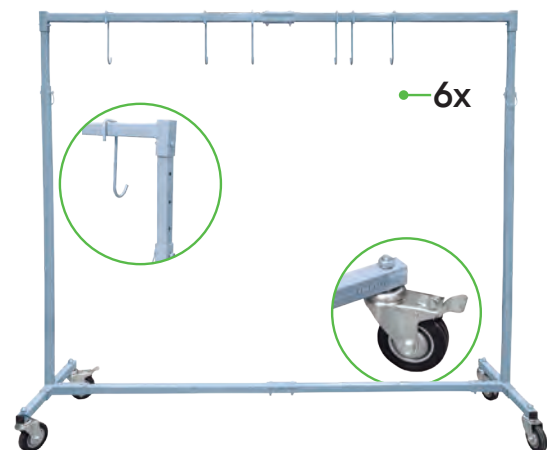

ROTATING PAINT STAND

53126 243,00€



- Ideal for doors, bonnets, bumpers, wings, spoilers, etc.

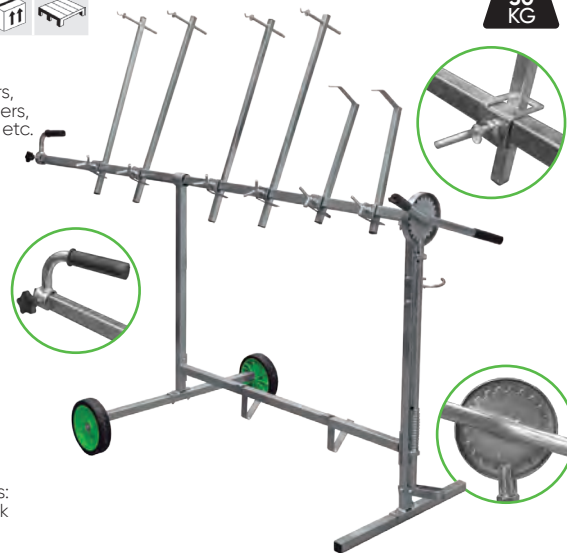

- 6 holding arms: 4 with fixed hook, 2 with holes

WALL PAPER ROLL DISPENSER

53922 29,00€



PAPER NOT INCLUDED

- Stainless steel
- Roll: Maximum width of 38 cm.

- Grey ABS plastic saw.
- Mounted with stainless steel screw and nuts.

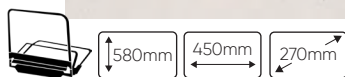

FLOOR STAND ROLL DISPENSER

53921 39,00€

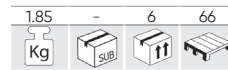

PAPER NOT INCLUDED



- Material: Stainless steel.
- Roll: Max. width 38 cm.
- ABS plastic saw.



SEAT COVER ROLLS

"CUIDAMOS" SPANISH MODEL / SHORT SEAT

51978 84,00€

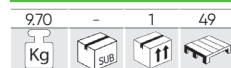

- Only available in spanish language.

25mc 250 u.



25 MICRONS THICK

WHITE MODEL / SHORT SEAT

52244 84,00€



25mc 250 u.



DISPLAY + VEHICLE CARE MATERIAL SET

INCLUDES REF.: 52065, 52244, 52057, 52058

50403 98,00€



INCLUDES REF.: 51985, 52244, 52057, 52058, 50409

50410 168,00€



INCLUDES REF.: 51985, 51978, 52057, 52058, 50409

50400 168,00€



SEAT + STERRING WHEEL + FOOT COVER DISPLAY

53705 80,00€

51985 84,00€

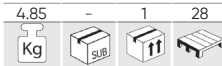
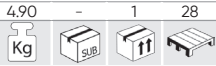

- Foot cover support.
- Seat cover support.
- Support handle film cover.

SEAT COVER DISPLAY

52065 45,00€

HANDLE FOR STEERING WHEEL COVER FILM

FILM

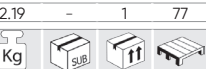

52057 6,80€

- Length: 200m
- Width: 12,5cm
- Thickness: 23mc

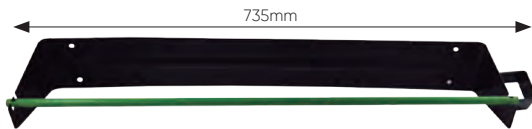
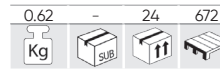

HANDLE

52058 4,50€



ANONYMOUS PAPER FOOTREST COVER

50409 26,00€

STEERING WHEEL COVERS

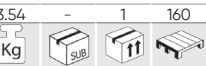

UDS PACK



51824 36,80€



250 UNITS

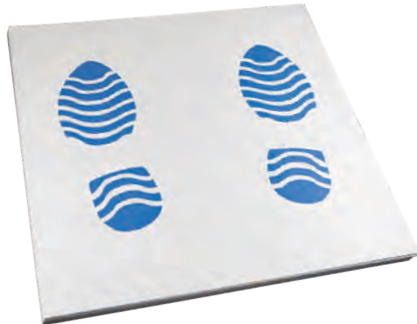

250 UNITS



MAINTENANCE KIT INDIVIDUAL BAG

50916 0,88€

DISPENSER



5in1



PAPER FLOOR MAT



CAR SEAT COVER

53226 14,90€

0,20	5	50	600
Kg	Sub	ft	ft

- Nylon
- Universal.

51cm 26,5cm 14mm

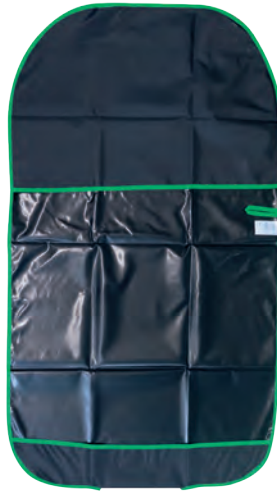

MAGNETIZED PROTECTIVE CURTAIN

51622 25,30€

0,45	-	30	540
Kg	Sub	ft	ft

110cm 64cm



4 MAGNETIZED POINTS

TWO FACES:
ONE VELVET /
ONE PLASTIC



PNEUMATIC SUCTION CUP DENT PULLER

52540 221,00€

4,36	-	3	72
Kg	Sub	ft	ft

- With slide hammer, making it easy to pull most dents out of panels.
- Instantly removes most dents without damaging paint.



620mm

160 L/min 70-110 PSI

Ø 75, 100, 125MM

PAD

CLOSED-CELL

53192 52,00€

0,70	-	2	48
Kg	Sub	ft	ft

- EVA foam.
- Measures folded:
20cm x 42cm x 18cm

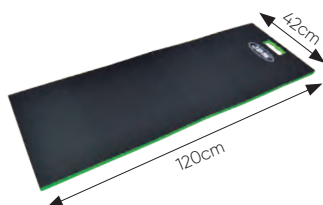

INDIVIDUAL

53191 14,80€

0,15	-	5	140
Kg	Sub	ft	ft

- EVA foam.



VAT not included

STEP ALUMINIUM WORKING PLATFORM

52230 398,00€



CERTIFICATION: EN131

16.75	-	1	14
Kg	sub	ff	

- Platform width: 300mm.
- Length of closed platform: 1.090mm.
- Length of extended platform: 1.750mm.
- Adjustable height of the platform: 520-900mm.
- Rung width: 40mm.
- Distance between rungs: 250mm.

- Positions: 42 (14 horizontals x 3 verticals).
- Height 1 : 520mm.
- Height 2 : 700mm.
- Height 3 : 900mm.

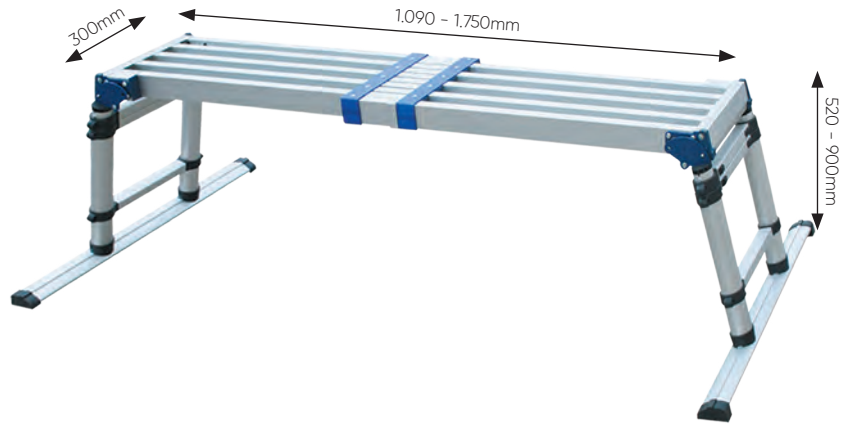

SUPER LIGHT



FOLDABLE



EASY ASSEMBLY



RUBBER STOPPED SPARE PARTS FOR REF. 52230

10966	0,06	1
13,50€	Kg	ff

LADDER SPARE PART FOR REF. 52230

10965	0,01	1
6,00€	Kg	ff

CORNER RUBBER SPARE PARTS FOR REF. 52230

10964	0,01	1
9,00€	Kg	ff

LARGE ALUMINIUM PLATFORM

50913 195,00€



CERTIFICATION: EN 131

6.50	-	1	20
Kg	sub	ff	

800mm	1.400mm	300mm
-------	---------	-------

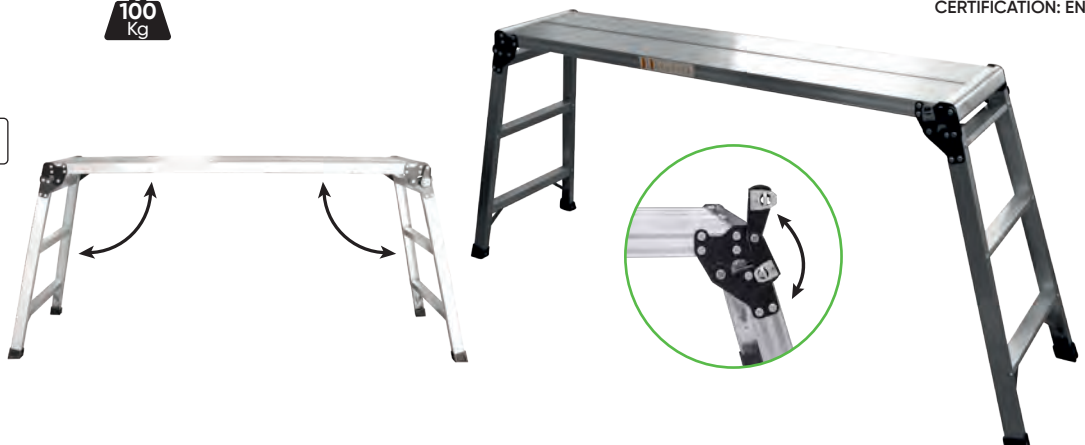

SET OF 2 ALUMINIUM PLATFORMS

50656 290,00€

CERTIFICATION: EN 131

10.45	-	1	8
Kg	sub	ff	



ALUMINIUM PLATFORMS

15552	181,00€	550mm	1.300mm	300mm
-------	---------	-------	---------	-------

11897	155,00€	300mm	1.000mm	300mm
-------	---------	-------	---------	-------

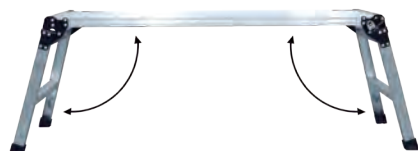
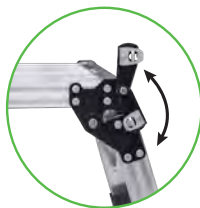

172



BRAKES

- 176 BRAKE PISTONS RETRACTOR TOOLS
- 178 BRAKE BLEEDER / MAINTENANCE

LOW PROFILE RETRACTOR TOOL

53683 116,00€

1.45	5	10	100
Kg	sub	ff	ff

- Working pressure: 5-8 BAR.
- Max. pressure: 14 BAR.
- Air inlet: 1/4".
- Magnetic disc holder.
- Workable with 2 and 3 pins discs.



AIR BRAKE PISTONS RETRACTOR TOOL

51283 78,00€

1.33	-	10	200
Kg	sub	ff	ff

- Working pressure: 5-8 BAR.
- Max. pressure: 14 BAR.
- Air inlet: 1/4".
- Magnetic disc holder.
- Workable with 2 and 3 pins discs.



BRAKE PISTONS RETRACTOR TOOL SET WITH PNEUMATIC TOOL

52636 114,00€

3.16	-	5	90
Kg	sub	ff	ff

16
PCS

0: GM most 2-1/2" diameter pistons (Seville/Eldorado 79)
 2: Citroën XM/Xantia (F/R), HONDA
 3: Audi (F), Fiat, Alfa romeo (F), Ford Fiesta (F), Isuzu (F), Honda Concesto (F), Jaguar XJ6/XJ40 (F/R), BMW 318is/320i/325TD/518i/525i-1x/740i/850ci/M5 (F), Mercedes BENZ 190/200/300/420/560 serie (F), Mitsubishi Colt (F), Nissan Miera/Stanza/Sunny (F), Rover Austin/Metro200-400 series/Maestra/Montego (F), Toyota Camry (F), VOLVO (F), VW Passat/Golf GTI (F)
 4: Ford Australia/NZ Telstar, Mazda (R), Saab 9000 (R)/Lumina, Toyota, Fiat 164 2.0 (R), Alfa Romeo Prelude/CRS 16i, Honda Saturn (R)/Grand Prix, GM
 5: 3/8" dr. Adapter should be used with an extension bar and ratchet if more strength needed to apply to piston.
 6: Nissan Primera, VW Golf IV
 7: Audi 80/90/V8+100/Coupe E (R), Rover 800 ABS, Subaru L+Z (R), Ford Sierra ABS/Granada/Scorpio ABS (R), Nissan Bluebird 1.8 Turbo/Silvia Turbo/Primera 2.0i LS-GS-GSX (R), Peugeot 405

19Gi/Gri/Sri/Gtxi/Mi 16/605 2.0 Sri (R), Toyota Cecilia/Corolla GT/MR2 (R), VW Golf Gti/Jeta Synchro/Jetta Gti 16v, Passat CL, GL, GT, GT 16v, Corrado 16V scirocco GTX 16V(R), Citroën, Alfa romeo, Fiat, Honda, Jaguar, Renault, Saab, Seat, Lancia.
 8: GM most 1-7/8" diameter pistons
 9: GM most 2-1/8" diameter pistons
 A (Z): Renault (R21-Laguna (R))
 E: Nissan Maximas/Cefiro
 F (G): Opel (Rear disk)/ Fiat Stilo
 K: Citroën C5
 M: Ford, Mini Cooper, Nissan Primera 03
 N: Saab, Honda, Alfa Romeo 164 2.0 Twin Spark/2.0 Turbo (88-)/3.0 V6, Audi 200 (80-)/Coupe GT SE (82-)/80/90/100/200/Quattro (87-)/90/20V (88-), Ford Mondeo 2.0/Ghia, Lancia Thema1te (85-), Volkswagen Golf II GTI (83-87)/Sirocco 16V (84).

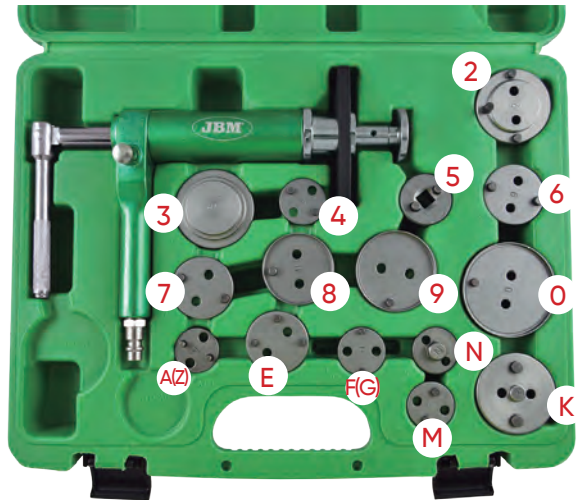

BRAKE PISTONS RETRACTOR TOOL SET

52330 99,00€

5.68	-	3	54
Kg	sub	ff	ff

OPEL
CITROËN

PEUGEOT
RENAULT

50
PCS

1pc: Right rotation clamp (with right-hand thread)
 1pc: Left-hand rotation clamp (with left-hand thread)
 0 disc: Citroën 1: Disc 11: Disc for Jaguar type S
 12: Disc for BMW mini
 5: 13/32" Adapter (5) with 3/8 Dr. Inside-pt
 2: Citroën XM, Xantia u.a.
 3: Alfa Romeo, Audi, Austin, BMW, Ford, Sling, Jaguar, Mercedes Benz, Mitsubishi, Nissan Rover, Toyota, VW
 4: Alfa Romeo 164 2.0, Ford, Mazda, Saab 9000, Subaru
 6: Nissan Primera, VW-Golf IV
 7: Audi 80,90, V8+100, Ford Sierra ABS + Scorpio ab 85, Honda Prelude, Nissan Silvia 1.8 turbo, Rover 8000, Saab 9000, Subaru L + Z, VW-Golf + Passat
 8: GM Motors G: Opel 9: GM Motors K: Citroën C5
 0: GM Motors K1, K2: Citroen, Renault. M: Ford
 A: Nissan Premira 2.0, Bluebird N: Saab, Honda B: Ford, Lincoln, Subaru
 Z: Renault C: Mini Austin E: Cefiro, Maxima
 D: Citroën, Renault F: Peugeot 206 CC / Hdi / Gti. Requires a 16mm wrench with rear pistons.
 P: Audi, BMW, Ford, Lancia, Piston, Renault, Rover.
 J: Jeep Alfa Romeo 155 1.8-2.0 164 TD (93) 164 3.0 V6 (91), Audi 80,90, A3, A4, A6, A8, Citroen ZX 2 Qi 16V, Fiat Type TD 16V, Uno Turbo (85) Crama TD, Ford Sierra (ABS bak). Granada (85) Crama TD, Ford Sierra (ABS bak). (Australia & NZ) Thunderbird Turbo, Honda CRX, 1.6i-16V (8-90), Accord 1800 (84-85) 2.0i. Prelude 16V (88), Legend V6, Jaguar XJ 4, Oseries, Lancia Dadra 2.0, Ei Tur (93), Delta 1.6 Gti, Nissan, Peugeot, Renault, Seat, Subaru, Volvo V40 & S40.
 R: Ford (Australia & NZ) Teslar, Laser, Mazda 323 Gti, GTXX (86-), 929 (82-), RX7 (81-), 626 16V (87-) 626 GT (86-), 929 V6 (88-), Mitsubishi Galant GL Si, Toyota Celica, Corolla GT, MR2
 S: Audi 100 TQ (91), BMW 740i 8cyl (91), Lancia Delta 19 TD (95), Proton 416. Renault-most models, Renault Laguna 2.0 (94), Laguna 2.2 D (95) Safrane 2.0-2.2 TD V6, Rover 623 Si, Volkswagen Golf Gtu Mk I & IV, Passat VR6, Wind GT (92)
 H6: BMW
 H7: BMW
 Pin 3.0
 Pin 5.5
 100g Fat
 1/2" Dr + 10mm Pentagon bit-56mm Brake System
 1/2" Dr + 14mm male-38mm - for pentagon brakes on the rear brakes of the Opel Astra G, Zafira, Smart
 1/2" Dr + 19mm male type-8mm- for Bendix, Citroën, Peugeot, Renault
 P1: Peugeot 307,308.

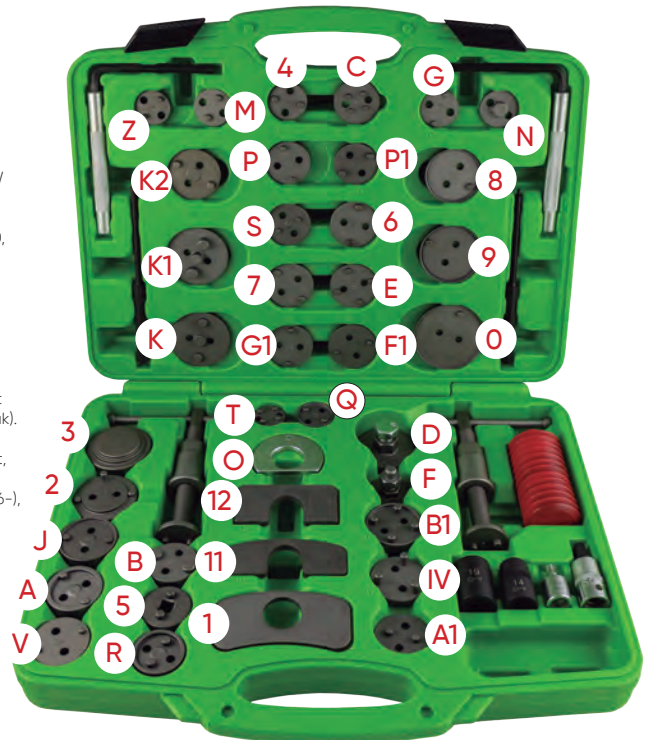

BRAKE PISTONS RETRACTOR TOOL SET

51059

99,00€

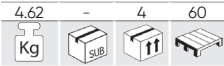

- Multiple use system with 37 pieces to reposition brake pistons.
- Can be used for most vehicles.
- Includes:
 - 2x hexagonal spanners (6 mm and 7 mm).
 - 2x planks for Mercedes and Opel brake systems.
 - 3x support cushions to use in brake shoes and work in areas with limited space.
 - 1x Contains bellow with lubricant oil. List of models of vehicles and uses.
 - With 26 adaptors for different cars.

- 1pc: Right rotating caliper (With right side thread) 1pc: Left rotating caliper (With left side thread) O: Plate 1: Disc.
 11: Disc for Jaguar S type. 12: Disc for BMW mini. 5: 3/8" Antriebs-Adapter 2: Citroen XM,Xantia (F/R)
 3: Alfa Romeo, Audi, Austin, BMW, Ford, Honda, Jaguar, Mercedes-Benz, Mitsubishi, Nissan, Rover, Toyota, VW.
 4: Alfa Romeo 164 2, 0, Ford, Mazda, Saab 9000, Subaru. 6: Nissan Primera, VW-Golf IV.
 7: Audi 80, 90, V8 +100, Ford Sierra ABS+Scorpio ab 85, Honda Prelude Nissan Silvia 1.8 turbo, Rover 8000, Saab 9000, Subaru L+Z, VW-Golf +Passat.
 8: GM Motors. 9: GM Motors. O: GM Motors. M: Ford. N: Saab, Honda. Z: Renault.
 E: Cefiro, Maxima. G: Opel. K: CitroenC5,K1,K2: Citroen, Renault. A: 1-3/16" Two Pin Disc for RENUIT R21, Laguna.
 B: Ford, Lincoln, Subaru. C: Mini Austin. D: Citroen, Renault. F: Opel (Rear Disk)
 P: Audi, BMW, Ford, Lancia, Proton, Renault, Rover, VW.
 J: Alfa Romeo 155 1.8-2.0 164 TD (93) 164 3.0 V6 (91) Audi, 80, 90, A3, A4, A6, A8 Citroen ZX 2 Ql 16V, Fiat Tipo TD 16V, Uno Turbo (85) Cra-
 ma TD, Ford Sierra (ABS bak), Granada (85), (Australia & NZ) Thunderbird Turbo, Honda CRX, 1.6l-16V (8-90), Accord 1800 (84-85)2.0i,
 Prelude 16V (88), Legend V6, Jaguar XJ40series, Lancia Dedra 2.0 Ei Tur(93), Delta 1.6Gti, Nissan, Peugeot, Renault, Seat, Subaru,
 Volvo V40& S40.
 R: Ford (Australia & NZ) Telstar, Laser, Mazda 323 Gti, GTX(86-), 929(82-), RX7(81-), 626 16V(87-), 626 GT (86-), 929 V6 (88-), Mitsubishi
 Galant GL Si, Toyota Celica, Corolla GT, MR2.
 S: Audi 100TQi(91), BMW 740i 8cyl.(91), Lancia Delta 19 TD(95), Proton 416, Renault-most models, Renault Laguna 2.0 (94), Laguna 2.2
 D(95), Safrane 2.0-2.2 TD V6, Rover 623 Si, Volkswagen Golf Gti Mk 3&4.Passat VR6, Vento GT(92).
 H6: BMW H7: BMW Pin Ø 3.0 Pin Ø5.5 100g Grease.

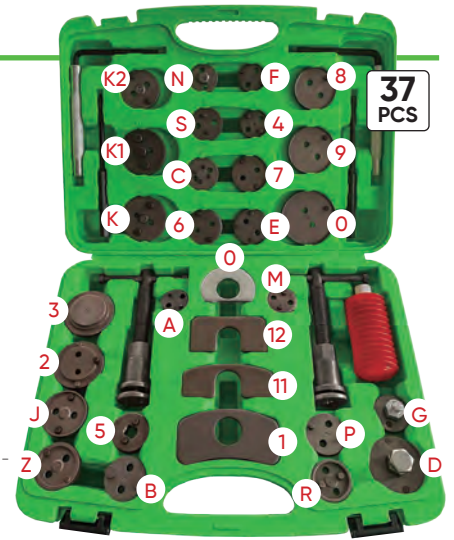

BRAKE PISTONS RETRACTOR TOOL SET

53978

38,90€

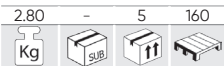

- Set used for the compression of the caliper piston.

- O: Plate
 1: Plate
 2: Citroën XM, Xantia
 3: Alfa Romeo, Audi, Austin, BMW, Ford, Honda, Jaguar, Mercedes-Benz, Mitsubishi, Nissan, Rover, Toyota, VW
 4: Alfa Romeo 164 2.0, Ford, Mazda, Saab 9000, Subaru
 5: Square adapter 3/8"
 6: Nissan Primera, VW.Golf IV
 7: Audi 80;90;V8+100, Ford Sierra ABS+Scorpio de 1985, Honda Prelude, Nissan Silvia 1.8 turbo, Rover 8000, Saab 9000, Subaru L+Z, VW Golf + Passat
 8: General Motors (Ø pistons 17/8")
 9: General Motors (Ø pistons 21/8")
 IV: VAG, Renault, Volvo with electronic parking brake
 A: Renault
 E: Nissan Maxima, Cefiro
 F: Opel
 J: For Fiat Tipo TD 16V, Uno Turbo(85) Crama TD, Honda CRX, Alfa Romeo 155 1.8-2.0i, 164 TD (93), 164 3.0 V6 (91); Audi 80, 90, & V8's, A3, A4, A6, A8 (rear calliper); Citroen ZX 2.Ql 16v; Fiat Tipo TD 16V, Uno Turbo (85-), Crama TD; Ford Sierra (ABS bak), Granada (85-); Ford (Australia & NZ) Thunderbird Turbo; Honda CRX, 1.6l-16V (88-90), Accord 1800 (84-85), 2.0i (86-),
 Preludi 16V (88-), LegendV6; Jaguar XJ 40 series; Lancia Dedra. 2.0 Ei Tur(93), Delta 1.6 Gti. (92), The. majE 16v(92), Thema. 2000 Turbo. Kappa 2.Q-2.4LS, 2.4TD; Nissan 280 ZX (82-84), 300 ZX Turbo (84-89), Bluebird 16V (89-), Silvia 1.8 Turbo (85-88) 100 NZ 2.0 (93), Primera 2.0 GT (94), 200 SX turbo 16V, Maxima 2.0 GX-3.0 GX (95); Peugeot 306; Peugeot 309 Gtj 16S (91), 405. Srif Q. rj, Gil (87-), 405 M.I 16V; Renault Master Van; Rover 216 Gti 16V, 820 Si 2.0(93), 825 SD 2.5 (93); Saab 9000 CS 2.0(93), 9000 CSE Turbo(93); Seat Toledo GT. 16V-GT 2.0(93), Lbiza 1.8 Gti 16V(95); Subaru Lserie & Serie 2; Volkswagen Passat 2.0 & 2.2 Litre(84), Golf Rallye (-89), Golf II Gti 16V(89-), Vento GT (92), Transporter T4; Volvo S40 & V40
 K: Citroën C5
 K1: Citroën
 K2: Citroën
 M: Ford
 N: Saab, Honda



BRAKE PISTONS RETRACTOR TOOL SET UNIVERSAL

52906

38,00€

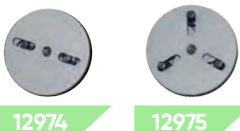
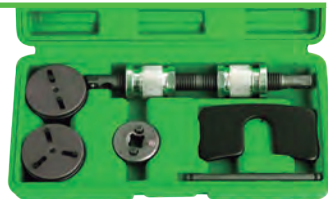
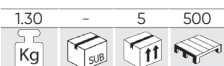

12974

12975

REF.	DESCRIPTION	Kg	11	€
12974	Spare 2 pins	0,15	50	21,00€
12975	Spare 3 pins	0,17	50	23,00€

- Alfa Romeo 164 2,0, Ford, Mazda, Saab 9000, Subaru, Nissan Primera, VW, Audi, Ford Sierra ABS + Scorpio ab 85, Honda Prelude, Nissan Silvia 1.8 turbo, Rover 8000, Saab 9000, Ford, Opel, BMW, Lancia, Proton, Renault, Rover, Peugeot 307, 308 A3- Iveco Daily, Volkswagen Passat 2.0 TDI 09, Renault Laguna.

BRAKE PISTONS RETRACTOR TOOL SET

14142

109,00€

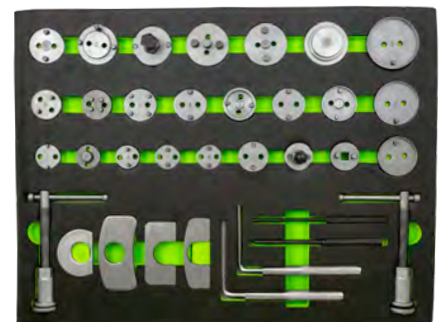
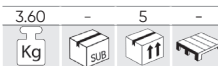

- 24x adaptors
- 4x special reaction plates
- 2x pin punches
- 2x hex keys with elongated handles
- 2x threaded rewind tools (left/right)

PROFESIONAL PNEUMATIC BRAKE BLEEDER

52191 198,00€

9,05	-	1	15
Kg	Sub	ft	ft

- Adjustable working pressure: from 0 to 4 Kg/cm²
- Entrance & Exit plugs.
- Weight: 5 Kg.
- N° of adapters: 11.
- Application range: GM, Chrysler, Nissan + 2 universal adapters.



330mm	230mm	230mm
-------	-------	-------



CYLINDER ADAPTER MASTER KIT

APPLICATION RANGE TO GM, CHRYSLER, NISSAN

52328 99,00€

2,90	-	4	68
Kg	Sub	ft	ft

- 9 Adapters brake oil: Universal n°1, n°2, n°3, n°4



BRAKE MAINTENANCE REPAIR SET

52434 125,00€

3,25	-	5	100
Kg	Sub	ft	ft

- Contents: Brake Line Flare Nut Wrenches. Brake Springs Pliers. Screwdrivers with Impact. Screwdrivers Sockets. Assembly tool. Screwdrivers Socket with universal Joint. Special tool for brakes. Brake Calliper Brush. Brass Brake Calliper Brush. Brake Cable Springs Pliers. Brake Clipper File. With integrated flat scraper for removing crude residues.



DRUM BRAKE SPRING PLIERS

52625 9,00€

0,35	6	48	1824
Kg	Sub	ft	ft

- For removing and installing return springs on brakes where the return.



BRAKE CALLIPER SOCKET SET

54135 82,00€

1,45	5	10	400
Kg	Sub	ft	ft

- Audi (A4, A5, S5, S8, Q5, Q7)
- Porsche (Cayenne, Macan, Cayman)
- Mercedes Benz
- Ford
- BMW
- Alfa Romeo

Designed for uninstalling the brake callipers when replacing brake pads.



1/2"				
	Øx2	14x38mm	22x38mm	
	Øx3	11,50x38mm	11x38mm	20x38mm
	Øx4	10mm	12,50mm	19mm
	Øx1	10mm		
3/8"				
	Øx4	H11X100mm	H7x70mm	H7x29mm H9x50mm
	Øx2	7x24mm	8x24mm	
1/4"				
	Øx1	9x20mm		

DISC BRAKE PISTON SEPARATOR

52315 16,00€

0,88	5	20	640
Kg	Sub	ft	ft

- Max. opening 80mm.



BRAKE FLUID TESTER

51839 24,00€

0,05	25	100	2400
Kg	Sub	ft	ft

- Operates with 1 x AAA batteries LR03.
- With 4 levels of measurable quality from 0-4%.



GAUGE FOR BRAKE PADS

52455 16,00€

0,26	10	20	864
Kg	Sub	ft	ft

COLOUR	METRIC	SAE
	8-10-12mm	0.3150-0.4720"
	4-5-6mm	0.1575-0.2382"
	2-3mm	0.0787-0.1181"



BASIC BRAKE BLEEDER

52275 38,00€

0,79	-	4	112
Kg	Sub	ft	ft



- Bottle capacity: 0.75 l.
- Work temperature: 10°C to 50°C.
- Silicone hose: 1m.
- Entrance air blowing pistol 1/4".
- Work pressure: 6-12 bar (87 - 174 psi).
- Air consum: 180l/min.





SPECIAL TOOLS

- 178 OIL FILTER WRENCHES
- 183 INJECTOR PULLERS
- 187 PLUG REPAIR SET
- 189 COMPRESSION TESTERS
- 190 IGNITION COIL PULLER
- 191 EXTRACTORS
- 203 RATCHET TORQUE WRENCHES
- 205 TORQUE MULTIPLIER
- 207 A/C SYSTEM
- 208 RADIATOR PRESSURE TESTER
- 210 CYLINDER / VALVES
- 211 SPRING COMPRESSORS
- 212 OTHERS
- 214 ORGANIZERS / TRAYS
- 215 CHAIN CUTTERS / BRUSHES

19 PIECES ALUMINIUM OIL FILTER CUP WRENCH SET

54068 198,00€

4,00	-	2	48
Kg	Sub	ff	

19
PCS

SPARE PARTS AVAILABLE

REF.	PIECE N°	CHARACTERISTICS	Ø x FLATS			€
15494	05101	Mazda, Mitsubishi	100,5mm x 15	5	10	12,50€
15495	0595	Nissan, Toyota	94,5mm x 15	5	10	12,50€
15496	0592	Nissan, Subaru	92mm x 15	5	10	11,50€
15497	0579	Toyota, Honda, Mitsubishi, Subaru, Mazda, Lsuzu	79mm x 15	5	10	11,00€
15498	915	Volvo	87mm x 16	5	10	11,50€
15499	901L	Lexus	79,5mm x 14	5	10	11,00€
15500	901T	Toyota	70mm x 14	5	10	10,00€
15501	901-1	Toyota	63-64mm x 14	5	10	10,00€
15502	902	Ford, Mazda	66,5mm x 14	5	10	10,00€
15503	1284	Dodge Sprinter (2007-), Mercedes Benz E320 (2007-), Jeep Cherokee 3.0L V6 Common Rail (2007-)	84mm x 14	5	10	11,00€
15504	903B	Mercedes Benz	74mm x 14	5	10	10,00€
15505	24mm	BMW 5, BMW 7, BMW X5 V8 (N62) (2004-), Saturn (2008), Astra 1.8L ECOTEC, Chrysler 3.6L V6 (2011-), 200, 300, T/C Dodge Jeep	24mm x 14	5	10	4,00€
15506	27mm	Mercedes Benz Classe A	27mm x 6	5	10	4,00€
15507	30mm	Audi A2, Vw Polo, Lupo 1.4L/1.6L	30mm x 6	5	10	4,50€
15508	32.5 mm	Opel Astra G, Corsa B, Zafira, Audi, VW 1-36 mm, Opel Omega, Vectra B, Zafira (98-), BMW M43/60	32,5mm x 6	5	10	4,50€
15509	36mm	Opel Omega, Vectra B, Zafira (98-), BMW M43/60, Mercedes Benz Vito CDI, C, E, VW Lupo 1.2 TDI, MAN	36mm x 6	5	10	5,00€
15510	38mm	Opel Vectra 2.0D	38mm x 6	5	10	5,00€
15511	917	Universal	55-90mm	5	10	8,00€

ALUMINIUM PARTS



23 PIECES OIL FILTER CUP AND WRENCH SET

51332 98,00€

4,20	-	5	60
Kg	Sub	ff	

23
PCS

SPARE PARTS AVAILABLE

REF.	PIECE N°	CHARACTERISTICS	Ø x FLATS	Kg			€
11374	901	Toyota, Nissan, Fiat Daihatsu	65mm x 14	0,10	5	20	5,50€
11375	902	Toyota, Daihatsu	67mm x 14	0,08	5	20	6,50€
11376	903	VW, Mercedes, BMW, Opel, Audi	74mm x 14	0,09	5	20	5,50€
11377	903-1	GM/AC, Wix, Ford, Isuzu	75mm x 15	0,09	5	20	5,50€
11378	903-2	VW, Audi, Seat, BMW, Renault	74mm x 8	0,09	5	20	6,50€
11379	903-3	Audi, Rover, Chrysler	74mm x 15	0,11	5	20	6,00€
11380	903-4	Toyota, Lexus	73mm x 14	0,11	5	20	6,50€
11381	903-6	Schlepper, Baumashinen	75mm x 12	0,10	-	50	6,50€
11382	918	Rover, Chrysler, Audi	74mm x 15	0,11	5	20	6,00€
11383	904	Nissan, Ford	79mm x 15	0,10	5	20	6,00€
11384	905	GM, Chrysler	73mm x 15	0,12	5	20	6,00€
11385	905-1	BMW, Mercedes, Opel, Audi, VW	74mm x 14	0,10	5	20	5,50€
11386	906	Baummaschinen, Schlepper	84mm x 18	0,10	5	20	6,00€
11387	907	Mitsubishi, Toyota	89mm x 15	0,13	5	20	6,00€
11388	908	Nissan, Toyota	91mm x 15	0,14	5	20	6,00€
11389	915	Honda Accord, Mitsubishi, Isuzu	90mm x 15	0,16	5	20	6,00€
11390	910	Toyota, Alfa Romeo, Ford	95mm x 15	0,12	5	20	6,00€
11391	911	Fiat, Renault, Citroën	80mm x 12	0,09	5	20	6,50€
11392	911-1	Subaru, Toyota, Honda, Nissan	80mm x 15	0,09	5	20	6,00€
11393	914	Mazda, Toyota	101mm x 15	0,18	5	20	6,00€
11394	909	Isuzu, Nissan	92mm x 15	0,14	5	20	6,00€

ALUMINIUM PARTS



REF.	CHARACTERISTICS	Kg			€
14992	12-Edge key	0,10	-	-	8,50€
10955	1/2" Ratchet	0,14	-	1 50	11,00€

OIL FILTER CUP WRENCH

52311 19,00€ 0,13 6 72 1728 Kg SUB I1 I2 VAG GROUP 42mm	52312 9,00€ 0,10 10 100 1800 Kg SUB I1 I2 VW, OPEL, MERCEDES, BMW, AUDI 74mm x 14C	52313 8,00€ 0,20 6 68 1008 Kg SUB I1 I2 VOLVO 540, 560, 570, 580 86mm x 16C
52314 26,60€ 0,20 5 50 600 Kg SUB I1 I2 BMW VOLVO 87mm x 16C	52809 8,50€ 0,15 10 100 1000 Kg SUB I1 I2	53441 9,80€ 0,20 5 20 800 Kg SUB I1 I2 TOYOTA 3/8" 64,5mm x 14C 76mm x 14C

OIL FILTER WRENCH FOR FORD, CITROËN, PEUGEOT 2.0, 2.2 HDI, TDCI

53008 15,50€

0,60 5 30 1500
Kg SUB I1 I2

250mm

UNIVERSAL FILTER WRENCH

52518 115,00€

1,40 6 12 480
Kg SUB I1 I2

95-165mm

9 PIECES OIL FILTER WRENCH SET

52615 112,00€

3,05 - 5 70
Kg SUB I1 I2

- Adjustable double key.
- Application range: 60-80mm.

Audi, BMW, Mercedes, Opel, Renault, Volvo, Kia, Hyundai, Ford, VW, Skoda, Citroën, Mini

9 PCS

1/2" x1 UNIVERSAL 63-83mm	6 - 27mm: Mercedes-Benz, Smart. - 32mm: GM, Opel/Vauxhall, Mercedes-Benz. - 36mm: Mercedes Diesel, BMW, Mini, Ford.	15 - 88,8mm: Hunday, Kia.
3/8" x8	14 - 64,5mm: Toyota (Allion, Auris, Corolla, Prius, Voxy, etc.). - 64,5mm: Toyota, Lexus (6 Zyl.). - 74,2mm: Audi, BMW, Ford, Toyota, Volkswagen, Porsche, Mercedes-Benz.	16 - 86,6mm: BMW 3+5+X, Volvo.

3 LEG OIL FILTER WRENCH WITH FLAT / ROUND LEGS

- It can be used with 1/2" or 3/8" spanners.

51352 9,80€ 0,40 5 40 960 Kg SUB I1 I2 57-118mm	51934 11,50€ 0,40 10 40 1200 Kg SUB I1 I2 57-118mm	51353 11,50€ 0,65 5 40 960 Kg SUB I1 I2 72-136mm	51923 12,50€ 0,56 10 40 960 Kg SUB I1 I2 72-136mm
---	--	--	---

- It extracts all 2-1/4" a 5" diameter oil filters.

- It extracts all 2-1/2" to 4" diameter oil filters.

- It extracts all 2-1/2" to 4" diameter oil filters.

- It extracts all 2-1/2" to 4" diameter oil filters.

5 PCS BENZ/AUDI ENGINE & TRANSMISSION DIPSTICK SET

53206 38,20€

5
PCS

0,55	5	20	140
Kg	Sub	ff	ff

- For checking the oil transmission fluid on Audi 100 engines:
The tip (first 11mm) is the 20°C cold fluid reading.
The second reading is the minimum at 80°C.
Third reading is at max 80°C.
- Maintain vehicle level when checking ATF.
- Engine dipstick for checking the oil level, compatible with a large selection of 1988 to 2005 engines in the Mercedes range. The dipstick is a service tool, therefore must be removed after the fluid has been checked.

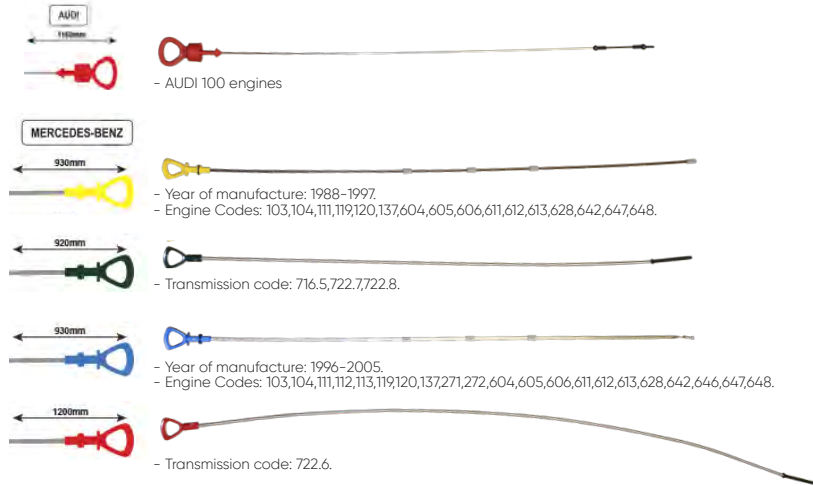

AUDI - ENGINE TRANSMISSION DIPSTICK

13856	0,04	5	100
7,80€	Kg	Sub	ff

OIL FILTER REMOVAL PLIERS

51354 13,20€

0,43	5	40	600
Kg	Sub	ff	ff

80-120mm



OIL FILTER WRENCH FOR DSG/VAG 1/2" 24MM

53670 29,50€

0,25	10	40	1680
Kg	Sub	ff	ff

1/2"

- Special tool designed for the assembly and disassembly of the oil filter of DSG gear.
- Its reduced size allows to reach easily the oil filter of DSG gear without remove any battery.



OIL FILTER WRENCH BAND

52269 7,00€

0,20	10	50	1200
Kg	Sub	ff	ff

80-120mm



REPLACEMENT 360mm

11106	0,02	10	50
3,00€	Kg	Sub	ff

OIL FILTER BAND WRENCH

52677 17,00€

0,32	10	40	480
Kg	Sub	ff	ff

Ø 65-105mm



52678 18,00€

0,33	10	40	400
Kg	Sub	ff	ff

Ø 110-155mm

REF.	REPLACEMENT	FOR	Kg	Sub	ff	€
11936	383mm	52677	0,03	10	100	4,00€
11937	540mm	52678	0,04	10	100	5,00€

OIL FILTER CHAIN WRENCH

52417 28,00€

0,90	5	25	800
Kg	Sub	ff	ff

Ø 160mm 300mm

HIGH STRENGTH CHAIN

DENTATED SURFACE FOR OPTIMAL GRIP



OIL FILTER STRAP WRENCH

52416 14,00€

0,37	5	50	900
Kg	Sub	ff	ff

Ø 150mm 20mm 540mm

POLYMER STRAP (HIGH RESISTANCE)

DENTATED SURFACE FOR OPTIMAL GRIP



OIL FILTER CHAIN WRENCH

52607 49,00€

0.85	6	24	576
Kg	Sub	Box	Tray

Ø 60 - 140mm

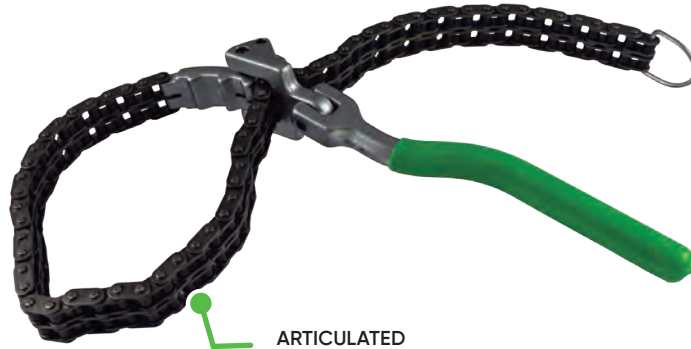

ARTICULATED DOUBLE CHAIN

52608 44,00€

0.95	6	24	360
Kg	Sub	Box	Tray

Ø 60 - 195mm

SET OF 5 OIL DRAIN PLASTIC PLUGS

53741 14,00€

0.05	10	100	4000
Kg	Sub	Box	Tray

FORD/PSA



13969 19,00€

0.01	10	100	-
Kg	Sub	Box	Tray

VAG



53537 14,50€

0.05	10	100	4000
Kg	Sub	Box	Tray

BMW



53538 14,50€

0.10	10	100	4000
Kg	Sub	Box	Tray

FORD



5 PCS

OIL DRAIN PLUG SOCKET SET

53735 44,00€

1.70	-	5	375
Kg	Sub	Box	Tray

3/8" 23 PCS

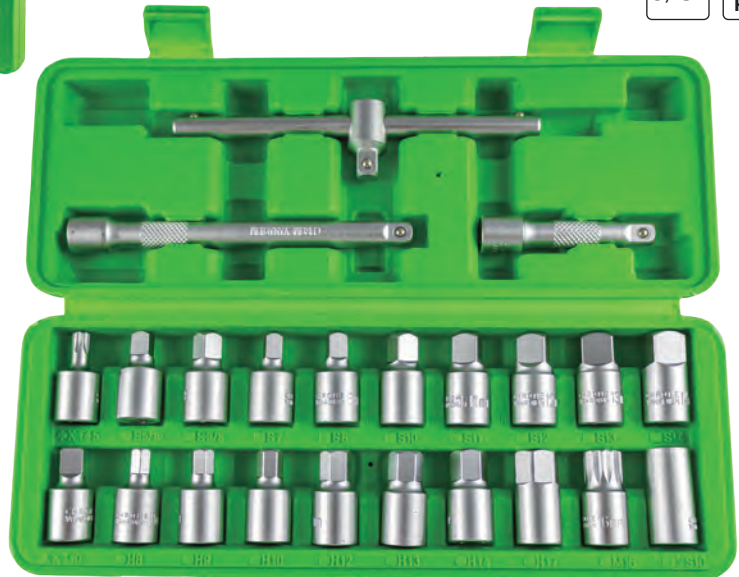

CONTAINS

	x2	5/16", 3/8"
	x7	7, 8, 10, 11, 12, 13, 14mm
	x1	10mm
	x1	10mm
	x7	8, 9, 10, 12, 13, 14, 17mm
	x1	T45
	x1	M16
	x1	200mm
	x2	75, 150mm

EVA TRAY - OIL DRAIN PLUG SOCKET SET

15084 68,00€

CARBON FIBER FINISH MODULE

1.70	-	-	-
Kg	Sub	Box	Tray

240x135x32mm

22 PCS

CONTAINS

	x2	5/16", 3/8"
	x7	7, 8, 10, 11, 12, 13, 14mm
	x1	10mm
	x1	10mm
	x7	8, 9, 10, 12, 13, 14, 17mm
	x1	T45
	x1	M16
	x1	200mm
	x1	150mm

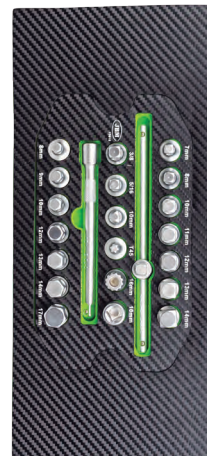

PLASTC OIL DRAIN PLUG WRENCH (VAG)

53472 12,00€

0.10	10	100	1200
Kg	sub	ff	ff

OEM: T10549



- Function: For the extraction of plastic oil drain plugs.

- Applications:

Audi: A1, A3, A4, A5, A6, A7, Q3, Q5, Q7, TT, TTS.
Seat: Alhambra, Leon, Toledo.
Skoda: Octavia, Rapid, Superb, Yeti.
VW: Beetle, Caddy, CC, Golf, Jetta, Passat, Polo, Scirocco, Sharan, Tiguan, Touran.

SPECIAL OIL DRAIN PLUG WRENCH

52617 7,00€

0.23	6	36	1512
Kg	sub	ff	ff

8 - 10mm

- For Citroën, Renault, Peugeot.



PLASTIC OIL DRAIN PWG DRIVER SET

53473 36,00€

0.40	10	50	800
Kg	sub	ff	ff

5
PCS

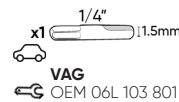
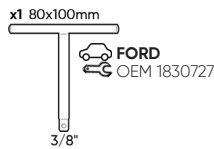

FORD, VAG, PEUGEOT,
CITROËN, BMW

OIL DRAIN PLUG REPAIR SET

51337 50,00€

1.55	-	10	180
Kg	sub	ff	ff



- SKS3 plugs.
- 1015 bits.
- Copper washers.

- Contents:
M13x1,5P
M13x1,5P
M13x1,5P
M20x1,5P

SPARE PARTS AVAILABLE

5 nuts + 5 washers*

*Delivered in bags of 5 units.
5 nuts + 5 washers

REF.	DESCRIPTION	Kg	sub	ff	ff	€
51403	M13 x 1.5P	0,13	5	50	100	17,50€
51400	M15 x 1.5P	0,17	5	50	100	17,00€
51401	M17 x 1.5P	0,15	5	50	100	22,00€
51402	M20 x 1.5P	0,10	5	25	50	20,50€

REF.	DESCRIPTION	Kg	sub	ff	ff	€
14930	M13 x 1.5P	0,05	10	100	100	9,50€
14931	M15 x 1.5P	0,05	50	100	100	8,00€
14932	M17 x 1.5P	0,07	5	100	100	9,50€
14933	M20 x 1.5P	0,10	5	100	100	9,50€

- Bits: 1 unit per measurement
- Plugs: 5 units per measurement
- Washer: 10 units per measurement



OIL PAN DRAIN SUMP PLUG KEY

53235 10,40€

0.25	10	40	-
Kg	sub	ff	ff

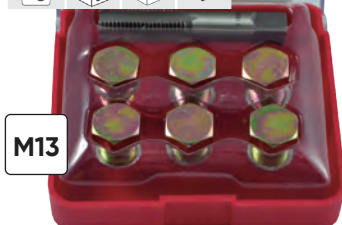

53236 11,50€

0.35	10	40	-
Kg	sub	ff	ff



53237 12,90€

0.35	10	40	-
Kg	sub	ff	ff



53238 18,40€

0.40	10	40	-
Kg	sub	ff	ff



PNEUMATIC INJECTOR PULLER

54186

320,00€

Bosch, Delphi,
Denso, Siemens

S

6-8 bar

20-30 Nm

6,79 - 2 80
Kg SUB



HYDRAULIC INJECTOR PULLER

54245

580,00€

Bosch, Delphi,
Denso, Siemens

1795 - 1 100
Kg SUB

This set of tools is designed to remove the tightest injectors with little effort, thanks to its hydraulic system that allows to exert a force of up to 10 tons.

Hydraulic cylinder connection: 3/8" NPT
Hydraulic cylinder force: 10 tons

Suitable for the extraction of diesel fuel injectors, specifically:

It has to be used with a hydraulic hand pump.

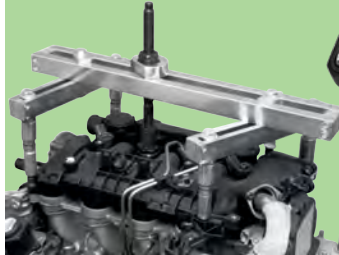

M17 x 1.0	Bosch	M20 x 1.0	Denso
M14 x 1.5	Delphi	M25 x 1.0 / M27 x 1.0	Siemens
M16 x 1.0	Toyota		

HYDRAULIC HAND PUMP

54257

318,00€

11,40 - 1 32
Kg SUB

FOR REF. 54245

Number of stages: 2
Working pressure:
Stage 1: 0-20 kg/cm³
Stage 2: 20-700 kg/cm³
Maximum work pressure: 1000 PSI
Usable oil: 700cc
Flow:
Stage 1: 13cc
Stage 2: 2.3cc
Hose length: 1,8m
Connection: 3/8" NPT
Weight: 10,32kg

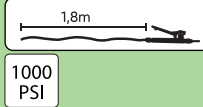

DIESEL INJECTOR PULLER SET FOR CITROËN, PEUGEOT

53069

98,00€

CITROËN
PEUGEOT

3,44 - 5 150
Kg SUB

- 1x Pulling Bridge.
- 3x Bridge Legs.
- 2x Extractor spindle - Ø17mm Ø25mm.
- 1x Drum nut for spindle.
- 2x Injector Cap Sockets of 25mm and 29mm.
- 1x Security Hex Key 21mm.



INJECTOR PULLER SET

51494

107,00€

3,60 - 4 96
Kg SUB

- With slide hammer for CDI engines and Mercedes CDI OM 611, 612, 613 engines, etc. to remove obstructed injectors and common rail without disassembling the head.
- The robust construction allows dramatic reduction of the most severely locked injectors.
- Material: S45C steel
- Total length: 350 mm L
- Contents:
Hammer: 1.75 kg.
Adapter: M17 x 1.0.
Adapter: M27 x 1.0 for Bosch injection nozzle.
Adapter: puller w/M12 x 1.75P.



DOUBLE OPEN END SPANNER FOR DIESEL INJECTOR PIPES

52821

28,80€

0,24 - 6 96 -
Kg SUB



- Material: Chrome Vanadium.
- Double open-ended ring wrench.
- Suitable for difficult access areas.

17mm

INJECTOR EXTRACTOR PULLER SET

52858 298,00€

- For removing of diesel injectors.
- Suitable for most diesel injectors because of many adapters included.

21,20	-	1	40
Kg	Sub	ff	

- Components:

3 different hammers:
1.6kg - 160mm long.
2.7kg - 460mm long.
5.1kg - 600mm long.

Pulling claws with fork opening:
13.7 x 18mm, 105mm long.
12.7 x 19mm, 130mm long.

Slotted 6pt 1/2" sockets, 100mm long.
Sizes: 25, 27, 28, 29, 30.
Injector extractor M17x1.0 spindle.

Pulling adapter with external thread:
M27 x 1.0 and M25 x 1.0.

Pulling adapter with internal thread:
M27 X 1.0 spindle.



INJECTOR COPPER RING ASSORTMENT 551 PCS

53464 153,00€

1,85	-	5	90
Kg	Sub	ff	



551
PCS

pg.328

DIESEL INJECTION PUMP PULLER FOR BMW

53501 24,00€

- Holds the sprockets during the assembly of the injection pump.

0,55	10	20	1120
Kg	Sub	ff	

- BWM: M47 / M47T2 / M47TU / M57 / M57TU.
- SERIES: E46 (318D-320D) (1988 - 2005) and E60, E61 (318TD-320TD-525D-530D-530-535) (2000 - 2006).
- OEM1 13 5 191 | 13 5 192 | 13 5 190 BMW.



INJECTOR PULLER SET FOR MERCEDES

52629 99,00€

MERCEDES

1,22	5	10	440
Kg	Sub	ff	



M16X1.5

INJECTOR LINE SOCKET SET

53009 42,00€

0,50	4	20	560
Kg	Sub	ff	



14, 17, 19mm



- Specific for MERCEDES (C/E/S CLASS, VITO) INJ.
- Extractor specific for MERCEDES injectors, complete with socket for dismantling the electrical connection.
- MERCEDES / BOSCH Injector Solution.

INJECTOR SEAL PULLER

53522 24,00€

Ø 4,5 - 15mm

0,80	5	20	480
Kg	Sub	ff	



DIESEL INJECTOR FLOW TEST KIT

51493

68,00€

Suitable for use in BOSCH, SIEMENS, DENSO and DELPHI

1.85	-	5	80
Kg	sub	ff	ff

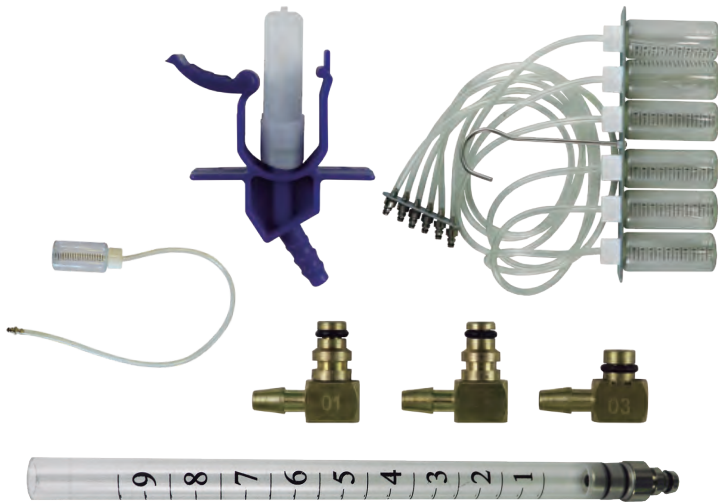

- The purpose of this instrument is to rapidly and efficiently measure the amount of fuel (diesel or gasoline) that each injector returns to the deposit tank so that you will know if an injector is damaged.

BOTTLE + CAP + HOSE FOR 51493

12901

5,20€

0.03	10	60
Kg	sub	ff

- The kit includes:
Hanger to hang with 6 graduated measurement bottles.
6 measurement tubes (for single crack condition).
Discount white tubes.
Storage case.

DIESEL INJECTOR SEAT CUTTER SET

52813

79,00€

2.23	-	5	180
Kg	sub	ff	ff



17
PCS

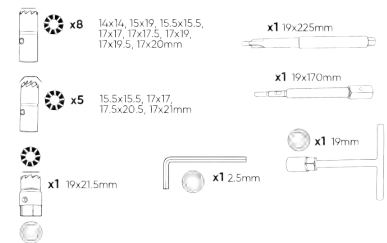

- 17 Pieces injector reamer set for the reconditioning of injectors.

DIESEL INJECTOR SEAT CUTTER SET

52273

44,00€

1.40	-	5	180
Kg	sub	ff	ff



8
PCS

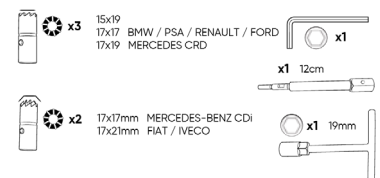

- Set to clean the injector seats when injectors are reconditioned or replaced in diesel engines.



INJECTION

INJECTOR SEAT CLEANING SET

53650 47,00€

0,90	-	10	140
Kg	Sub	ft	ft



- 3x Brass coated Steel wire brushes for cleaning diesel injector seats prior to fitting new injectors and 2x silicone nylon brushes to clean the base of the seat.
- Cleaning brushes can be quickly connected to the flexible extension provided.
- This kit also contains: 6 x port sealing plugs plus insertion rod to prevent carbon deposits from accidentally entering the combustion chamber during the process; and 1 x Steel wire injector nozzle port cleaner to clean the bottom of the seat.

- Containing:
3x brass brush.
2x silicon-nylon brush.
1x extensor.
6x combustion chamber sealing plugs.
1x insertion rod for sealing plugs.
1x Injector nozzle port cleaner.



SET OF 3 BRASS CLEANING BRUSH (REF.53650)

14348	0,05	50
12,50€	Kg	ft



SET OF 2 SILICON CLEANING BRUSH (REF.53650)

14349	0,07	100
20,50€	Kg	ft

INJECTION PUMP SOCKET SET

53330 38,00€

0,75	-	20	144
Kg	Sub	ft	ft

- BOSCH injection pump.
- TDI.
- Common Rail.



Cr-V 1/2" 1/4" 5 PCS



DIESEL SERVICE FILLING PUMP

52801 26,00€

0,10	5	50	600
Kg	Sub	ft	ft



- During replacement of the injection pump, filters or other parts, prevents retraction of the fuel to the tank.
- After the assembly of parts to replace pump, it allows to pump the fuel to the injection line.

O2 SENSOR SOCKET SET

51491 154,00€

3,99	-	5	150
Kg	Sub	ft	ft

- 17x78mm (12PT): Renault, Audi, VW, Skoda, Alfa Romeo, Mitsubishi.
- 19x78mm (12PT): VW, Polo, Audi, Seat, Mazda.
- 20x78mm (6PT): Deschis Japon.
- 27x78mm (6PT): Deschis Japon.
- 21x90mm (12PT): Seat, Audi, VW, Skoda, Opel.
- 22x78mm (12PT): Seat, Audi, VW, Skoda, Opel.
- 22x110mm (12PT): Mercedes, Citroen, Peugeot, Ford, Nissan, Mazda, Mitsubishi, Seat, Audi, VW, etc.



14 PCS

OXYGEN SENSOR WRENCH

52822 32,00€

22mm

0,41	5	20	-
Kg	Sub	ft	ft

- Open ring wrench, allows the extraction of oxygen sensors located in inaccessible places.



ARTICULATED HEAD



BMW FUEL INJECTOR PULLER / INSTALLEER TOOL MERCEDES BENZ

54220 197,00€

4,40 - 2 240
Kg SUB ff

APPLICATIONS
BMW:
 135is (2008-),335 (2007-),335xi (2007-),535i (2008-),535xi (2008-),550i GT (2010-),750Li (2009-),750i (2009-), X3 3.0i (2007-),X5 (2011-),X5 3.0i (2008-),X6 (2008-)
MERCEDES-BENZ:
 C-class (2007-),CLK / SLK (2007-),E-class (2007-),A / CLA / GLA 45 AMG (2013-),CL / CLS 63 AMG (2010-),E / G / GL 63 AMG (2011-),GLE 63 AMG (2015-),S / SL 63 AMG (2010-),SLK 55 AMG (2012-)

OEM TOOLS
 BMW: 130180(1), 130195(2), 130270(3), 130320(4), 2249115(5)
 Mercedes-Benz: 271589023300(6), 278589003300(7)

ENGINE CODES
 BMW : N14 / N18 / N20 / N47 / N54 / N57 / N55 / N63
 Mercedes-Benz :M133 / M152 / M157 / M270 / M271 / M274 / M276 / M278

pg.183

INTERNAL AND EXTERNAL THREAD REPAIR SET

54003 104,00€

1,60 - 10 270
Kg SUB ff

9 PCS
CrMo

Thread sizes:
 - M14x1,5
 - M16x1,5
 - M18x1,5
 - M20x1,5
 - M22x1,5
 - M24x1,5
 - M27x2,0
 - M28x1,5

7 PCS O2 SENSOR SOCKET SET

51119 62,00€

2,09 5 10 240
Kg SUB ff

1/2" 3/8"

- Contents:
 1/2" 29 x 9 socket with 90 mm length.
 1/2" to 7/8" socket with 50 mm length.
 1/2" 27 x 12 socket with 78 mm length.
 3/8" to 7/8" x 6 socket with 90 mm length.
 3/8" to 7/8" x 6 socket with 90 mm length.
 3/8" to 7/8" socket with 30 mm length.
 3/8" to 1" and 1-1/16" socket with 74 mm length.

115 PIECE THREAD REPAIR SET

51896 82,00€

2,10 - 5 300
Kg SUB ff

115 PCS

REF.	CHARACTERISTICS	Kg		€ / x5
52016	Replacement helicois M5x0,8	0,01	10	2,10€
52017	Replacement helicois M6x1,0	0,01	10	2,40€
52018	Replacement helicois M8x1,25	0,05	10	2,60€
52019	Replacement helicois M10x1,50	0,01	10	3,20€
52021	Replacement helicois M12x1,75	0,02	10	3,40€

REF.	CHARACTERISTICS	Kg		€ / x5
52022	Replacement helicois M14x2,0	0,01	10	4,50€
52023	Replacement helicois M16x2,0	0,01	10	6,60€
52024	Replacement helicois M18x2,5	0,05	10	10,60€
52025	Replacement helicois M20x2,5	0,01	10	13,00€

- Contents:
 Bit.
 Finishing tap.
 Helicoil inserter.
 Breakage pointer.
 Stainless steel spiral set.

- Measurements:
 25 x M5x0.8
 25 x M6x1
 25 x M8x1.25
 25 x M10x1.5
 10 x M12x1.75

INJECTION

51897 122,00€

2,21 - 5 378
Kg SUB ff

39 PCS

- Contents:
 Bit.
 Finishing tap.
 Helicoil inserter.
 Breakage pointer.
 Stainless steel spiral set.

- Measurements:
 9 x M12x1.75
 9 x M14x2
 9 x M16x 2.0

THREAD REPAIR SET

53041 37,60€

0,54 - 10 1000
Kg SUB ff

- SPECIAL SPARK PLUGS.

M14x1,25

51898 139,00€

1,81 - 4 252
Kg SUB ff

M18x2,5

51899 137,00€

2,12 - 4 252
Kg SUB ff

M20x2,5

- Contents:
 • Bit.
 • Finishing tap.
 • Helicoil inserter.
 • Breakage pointer.
 • Stainless steel spiral set.

660 PIECE METRIC CASE TAPS AND DIES METRIC AND INCH COMBINED

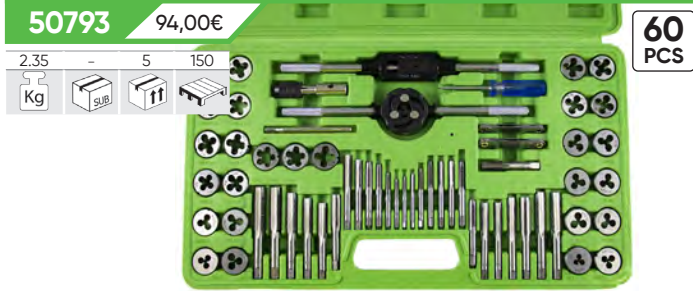

1 Male NPT and 1 die stock NPT: 1/8-27.
1 Male Porta Combined M3-M12 and 3/16" - 1/2".
1 Males Porta mixed type 1: M3-M6 and 4-40 6-32.
1 Joint holder dies: 25 mm diameter.
1 Screwdriver.
1 Metric set of thread gauges.
1 Metric set of thread inches.
10 Males (metrics): M3x0.5, M4x0.7, M5x0.8, M6x1.0, M7x1.0, M8x1.25, M9x1.25, M10x1.0, M10x1.5, M12x1.75.
10 Taps UNC (inches): 4-40, 6-32, 8-32, 10-

24, 12-24, 1/4-20, 5/16-18, 3/8-16, 7/16-14, 1/2-13.
6 Dies UNF (inches): 10-32, 1/4-28, 5/16-24, 3/8-24, 7/16-20 1/2-20.
10 Dies (metric) M3x0.5, M4x0.7, M5x0.8, M6x1, M7x1, M8x1.25, M9x1.25, M10x1, M10x1.5, M12x1.75.
10 Males UNC Dies (inches): 4-40, 6-32, 8-32, 10-24, 12-24, 1/4-2, 5/16-18, 3/8-16/7/16-14, 1/2-13.
6 Dies UNF (inches): 10-32, 1/4-28, 5/16-24, 3/8-24, 7/16-20, 1/2-20.

58 PIECE METRIC CASE TAPS AND DIES WITH TITANIUM-COATED



1 NPT tap: 1/8-27.
1 NPT die: 1/8-27.
1 Tap holder: M4-M12.
1 T-type tap holder: M3-M6.
1 Die holder: 25mm O/D.
1 Screwdriver.
1 Set of thread gauges.

17 Taps: 2x0.4, 3x0.6, 3x0.5, 3.5x0.6, 4x0.75, 4x0.7, 5x0.8, 6x0.75, 6x1.0, 7x0.75, 7x1, 8x1.0, 8x1.25, 10x1.25, 10x1.5, 12x1.25, 12x1.75.

17 Screwing dies: 2x0.4, 3x0.6, 3x0.5, 3.5x0.6, 4x0.75, 4x0.7, 5x0.8, 6x0.75, 6x1.0, 7x0.75, 7x1.0, 8x1.0, 8x1.25, 10x1.25, 10x1.5, 12x1.25, 12x1.75.

UNIVERSAL COOLING SYSTEM PRESSURE TEST KIT (5 PCS)



- During replacement of the injection pump, filters or other parts, prevents retraction of the fuel to the tank.
- After the assembly of parts to replace pump, it allows to pump the fuel to the injection line.

VACUUM AND FUEL PUMP TESTER



VACÍO VACUUM 0-28 inHg (0-70 cmHg)

PRESIÓN PRESSURE 0-0,7 kg/cm² (0-10 PSIG)

COMPRESSION TEST KIT OIL

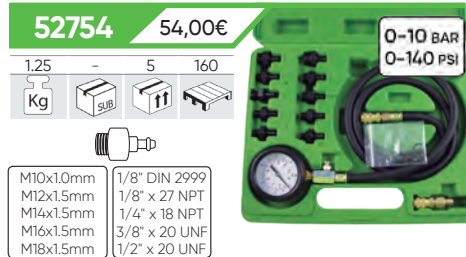

M10x1.0mm
M12x1.5mm
M14x1.5mm
M16x1.5mm
M18x1.5mm



1/8" DIN 2999
1/8" x 27 NPT
1/4" x 18 NPT
3/8" x 20 UNF
1/2" x 20 UNE

- Useful for checking the oil pressure and diagnosticate system problems.
- Includes 10 adaptors that cover most vehicles on the market.

TURBO PRESSURE GAUGE



-1-3BAR 2M

COMPRESSION TEST DIESEL FOR TRUCKS



0-70 BAR
0-1000 PSI

- This diesel compression tester set includes all the necessary components to test diesel compression on most diesel fueled trucks, cars and tractors.
- The compression tester is constructed of durable carbon steel and features a

chrome plated gauge to get accurate measurements in harsh environments.
- Features include a swivel-end quick-coupler for easy change-out and connection of adapters.
- Adaptors M18 and M24.

COMPRESSION TEST KIT GASOLINE

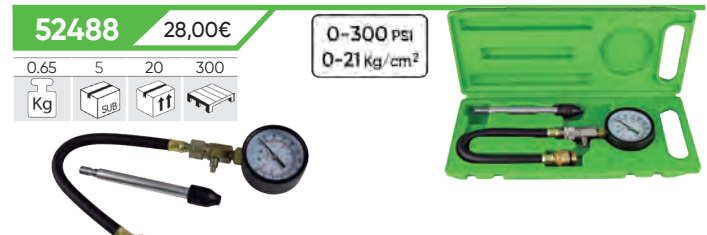

0-300 PSI
0-21 kg/cm²

- Dual calibrated gauge reading (0-300psi, 0-2000kpa) with side release valve.
- This 2 piece compression tester kit is ideal for use with most petrol engines.

FUEL LINE DISCONNECT PLIER SET

53445 17,10€

0,35	12	48	576
Kg	Sub	Box	Tray



5/16"
8mm Ø



3/8"
10mm Ø



SPECIAL APPLICATION



FUEL INJECTION PRESSURE TEST KIT GASOLINE

53997 48,00€

1,40	-	5	150
Kg	Sub	Box	Tray

- For the detection of failures in the fuel system.
- Compatible with Schrader injection systems.



1 Length: 25,5cm
Outer diameter: 1,2cm
Inner diameter: 0,6cm

2 Length: 29,5cm
Outer diameter: 1,2cm
Inner diameter: 0,6cm

3 Length: 110cm

FUEL INJECTION PRESSURE TEST KIT GASOLINE

52599 230,00€

4,00	-	5	60
Kg	Sub	Box	Tray

0-145
PSI

0-1000
KPA



- Contains all items necessary for checking fuel injection on most cars.
- Features large 3-1/2" gauge with dual readings of 0-145 psi & 0-1000 KPA and a 2-1/2" gauge with dual readings
- All adapters, gauges & hose assemblies feature a quick coupling system.



COMPRESSION TEST KIT DIESEL

52489 58,00€

2,15	-	6	144
Kg	Sub	Box	Tray

- Ford, BMW, Mercedes Benz, VW, Citroën, Mitsubishi, Toyota, Peugeot, Renault, Volvo, Mazda.

- Complet tester to check compression of diesel engine.
- Quick connect/disconnect feature allows one Gauge to be used with variety of quick adapters for most popular diesel engines.
- Adaptor M18 and M24.

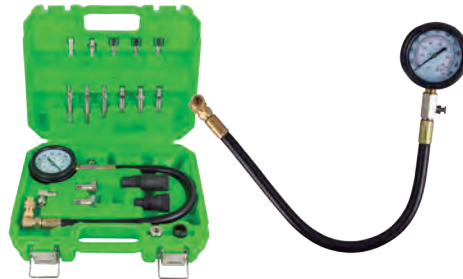

0-1000 psi
0-70 Kgs/cm²

M18x1.5mm
M24x2.0mm
M24x1.5mm



M10x1.0x68mm
M10x1.25x54mm
M10x1.25x68mm
M12x1.25x45mm

COMPRESSION TESTER KIT DIESEL

51893 690,00€

4,25	-	3	54
Kg	Sub	Box	Tray

0-1000 Psi
0-70 Kgs/cm²



- Injection unit adapter and test kit Large, 2-1/2", 70 kg/cm² (1000 PSI) measurer protected with rubber, straight and straight angle.
- Rapid connection accessories and a wide range of adapters.
- Suitable for coverage of most vehicles, lorries, vans, coaches, agricultural and marine diesel motors.

- With adapters for: Alfa, BMW, Chrysler, Daewoo, Fiat, Ford, Hyundai, Isuzu, LandRover, LDV, Mazda, Mercedes, Mitsubishi, Nissan, Opel, PSA, Renault, Suzuki, Saab, Toyota, VAG, Opel, Volvo diesel ranges.
- Injector: M20, M22, M24 and Ford.

PETROL AND DIESEL COMPRESSION TEST KIT

53490 275,00€

5,50	-	2	40
Kg	Sub	Box	Tray

- Alfa Romeo, BMW, Chrysler, Citroen, Daewoo, Fiat, Ford, Honda, Hyundai, Isuzu, Jeep, Kia, Lada, Lancia, Land Rover, LDV, Mazda, Mercedes, MG, Mitsubishi, Nissan, Peugeot, Renault, Rover, Saab, Ssangyong, Suzuki, Toyota, VAG, Vauxhall/ Opel, Volvo.

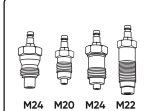

GLOW PLUG THREAD REPAIR SET

52076 111,00€

0,85 - 10 36



1. Insertion tools - 2 units
2. Handle for piece 8 - 1 units
3. Thread M8 x 1.0 - 5 Units
4. Thread M10 x 1.0 - 5 Units
5. Thread M10 x 1.25 - 5 Units
6. Thread M12 x 1.25 - 5 Units
7. Insertion heads - 3 units
8. Thread insertion rod - 1 Unit

- A. Cutting insertion M14 x 1.25 (for M12 x 1.25 threads) - 1 unit
- B. Cutting insertion M12 x 1.25 - 1 unit
- C. Cutting insertion M12 x 1.0 (for M10 x 1.25 threads) - 1 unit
- D. Cutting insertion M10 x 1.25 - 1 unit
- E. Cutting insertion M10 x 1.0 (for M8 x 1.0 threads) - 1 unit
- F. Cutting insertion M8 x 1.0 - 1 unit

REF.	CHARACTERISTICS	Kg	5	€
11893	Helicoil M8x1,0	0,01	5	7,00€
11894	Helicoil M10x1,0	0,01	5	7,00€
11895	Helicoil M10x1,25	0,05	5	8,65€
11896	Helicoil M12x1,25	0,01	5	8,80€

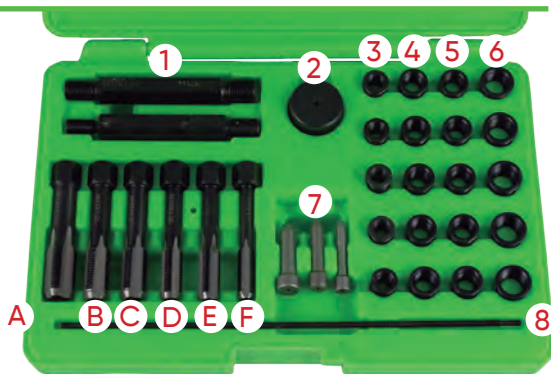

GLOW PLUG REMOVAL SET

52305 106,00€

1,79 - 10 180



16
PCS

- This set is useful for removal of broken or obstructed heater.
- Universal and ideal for Mercedes Benz CDI engines.
- It removes of broken or obstructed M8 M10 taps.
- It includes 1/4" M8 taps and high resistance-double size M8 and M10 step bit.

GLOW PLUG TIP REMOVER SET

52815 110,00€

0,95 - 5 280



- Tools specially designed to extract heater electrode tips in case of breakage during the extraction process.
- Easy removal without lifting the cylinder head.

GLOW-PLUG CONNECTOR PLIERS

52816 28,10€

0,27 6 36 -

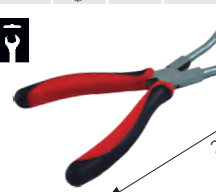

52817 23,50€

STRAIGHT

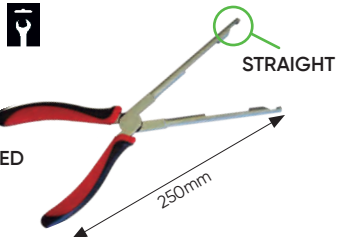

- Pliers useful for removing the connectors in Diesel heaters.
- Indicated for a quick extraction.
- These pliers allow working without any risk of damaging the heater or other vehicle parts, even though the connectors are located in inaccessible places.
- Ergonomic rubberized handle.

TWIST SOCKET WHELL LOCK NUT REMOVER SET 1/2"

52153 46,00€

0,93 5 20 640



17, 19, 21, 23, 27mm 1/2"

TWIST SOCKET SET WHELL LOCK NUT REMOVER 3/8"

51998 38,00€

0,69 5 20 360



9, 10, 11, 12, 13, 14, 15, 16, 17, 19mm 10 PCS



52962 42,00€

0,75 5 20 1500



6, 8, 10, 11, 12, 13, 14, 15, 16, 17, 19mm 11 PCS



NEW DESIGN:
HEXAGONAL
PART

3/8"

CR-MO

MASTER LOCKING WHEEL NUT REMOVER SET

54253 166,00€

1,85	-	-	700

Simple to use master kit capable of removing Practically any locking wheel nuts
Kit includes shrouds, which protects the wheel against any damage.
Very effective and a must have workshop tool
The kit contains two sizes of impact cutting blades to fit most common locking wheel nuts by cutting into the outer rim
Also included are three double sided blades for moulding in to the socket shape directly
Universal - Removes a wide range of sizes, type and profiles including those with spinning collars
Includes impact driver and punch.



WHEEL LOCK SCREW SOCKET SET FOR BMW

53208 126,00€

0,95	5	20	-

41-60 BMW 22 PCS

- BMW Serie 1 F20/F21.
- BMW Serie 3 F30/F31.
- BMW Serie 4 F32/F34/F36.
- BMW Serie 5 F10/F11.
- BMW Serie 6 F12/F13.
- BMW Serie 7 F01/F02/F04.



WHEEL LOCK SCREW SOCKET SET FOR VW

53207 118,00€

1,55	5	10	330

- b51 / 6pt
- b52 / 7pt
- b53 / 8pt
- b54 / 9pt
- b55 / 10pt
- b56 / 11pt
- b57 / 12pt
- b58 / 13pt
- b59 / 14pt
- b60 / 15pt
- b61 / 16pt
- b62 / 17pt
- abc0 / 10pt
- abc1 / 11pt
- abc2 / 13pt
- abc3 / 14pt
- abc4 / 15pt
- abc5 / 16pt
- abc6 / 17pt
- abc7 / 19pt
- abc8 / 20pt
- abc9 / 21pt



WHEEL LOCK SCREW SOCKET SET FOR BMW

52802 54,00€

0,62	-	20	-

- Useful to remove the screws.



10 PCS BMW

- 30/13 PT,31/15 PT,32/16 PT,33/17 PT,34/18 PT,35/19PT,36/20 PT,37/21 PT,38/22 PT,40/23 PT



WHEEL LOCK SCREW SOCKET SET FOR VAG

52823 124,00€

0,94	5	20	-

VAG 22 PCS
A, B, C, E, F, G, H, I, J, L, M, N, P, Q, R, S, T, V, W, X

- Set specially designed to remove the safety screws on Volkswagen vehicles wheels, covering almost 100% of the fleet of VW vehicles in the market.



WHEEL LOCK SCREW SOCKET SET FOR MERCEDES

53328 76,00€

0,60	5	20	-

MERCEDES 12 PCS
5A, 5C, 5D, 5E, 5F, 5G, 5N, 5L, 5P, 5X

- Clase A, B, C, GLK, CLC, CLS, CLK, E, SL, SLK, M, C300, C250, C350, E320, 204, 211, 212, R.



WHEEL STUD THREAD RESTORER KIT

53652 53,00€

0,94	5	10	240

- M12x1.25 - PSA
- M12x1.5 - MERCEDES BENZ / BMW
- M12x1.75 - VOLVO
- M14x1.5 - VAG



- Tool set for repairing and reconditioning wheel bolts, as well as anchoring it to the female thread of the vehicle; useful in partially damaged threads.

IGNITION COIL PULLER SET FOR VW

51495 59,00€

0,96	-	20	200

VW

- For damage free removal of ignition coils.
- Fits VW ENGINES CYL 8 & 12 and for 5 & 6 CYL for Golf, Bora in 4 & 5 CYL. - Also for PAS-SAT with 6CYL Sharan, Touareg and Phaeton too.
- To removaill ignition coils with power unit like VW Polo, Golf 1.4, 1.6i, 1.4i, Caddy, Bora 1.4, 1.6 and Phaeton, Passat Touran 1.6i and Transporter T4.



SPARE PARTS AVAILABLE



REPAIRING DISK

REF.	CHARACTERISTICS	Kg	IT	€
14344	M12x1.25	0,49	20	11,00€
14345	M12x1.5	0,50	20	11,00€
14346	M14x1.5	0,46	20	11,00€



REPAIRING BOLT

REF.	CHARACTERISTICS	Kg	IT	€
14340	M12x1.25 - PSA	0,05	20	10,50€
14341	M12x1.5 - MERCEDES / BMW	1,14	20	10,50€
14342	M12x1.75 - VOLVO	1,12	20	10,50€
14343	M14x1.5 - VAG	1,29	20	10,50€

BROKEN TAP EXTRACTOR SET

51496 8,00€ **5** PCS

0.12	12	72	2016
Kg	SUB	↑	↑



N° 1: 1/8" - 1/4" (M 3-6)
 N° 2: 1/4" - 5/16" (M 6-8)
 N° 3: 5/16" - 7/16" (M 8-11)
 N° 4: 7/16" - 9/16" (M 11-14)
 N° 5: 9/16" - 3/4" (M 14-18)

- Manufactured from a thermal treatment of chromium molybdenum steel.
- Achieves rapid extraction with the aid of the helices acting as screw.

TAP EXTRACTOR KIT

53502 38,70€ **9** PCS

0.55	5	20	900
Kg	SUB	↑	↑



#2 M5
 #3 M6
 #4 M8
 #5 M10
 #6 M12
 #7 M14
 #8 M16
 #9 M20
 #10 M22

1/2" STUD PULLER SET

52833 39,30€ **1/2"**

0.80	5	20	-
Kg	SUB	↑	↑



6, 8, 10, 12mm

SPARE PARTS AVAILABLE

REF.	DESCRIPTION	Kg	SUB	↑	↑	€
14211	6mm	0,10	20	100		11,00€
14212	8mm	0,10	20	100		12,00€
14213	10mm	0,20	20	100		12,00€
14214	12mm	0,20	20	100		14,00€

FLARING TOOL SET

52700 20,50€ **3/16, 1/4, 5/16, 3/8, 1/2"**

0.95	6	12	468
Kg	SUB	↑	↑



GLOW PLUG SOCKET SET

52691 54,00€ **3/8"**

0.79	6	24	480
Kg	SUB	↑	↑



8, 9, 10, 12, 14, 16mm

WITH MECHANICAL HOLDING SYSTEM

MAGNETIC SPARK PLUG SOCKET

52317 19,90€ **3/8"**

0.30	12	72	2880
Kg	SUB	↑	↑

250mm

Ø16mm

52316 18,90€

0.20	12	48	2880
Kg	SUB	↑	↑

Ø14mm

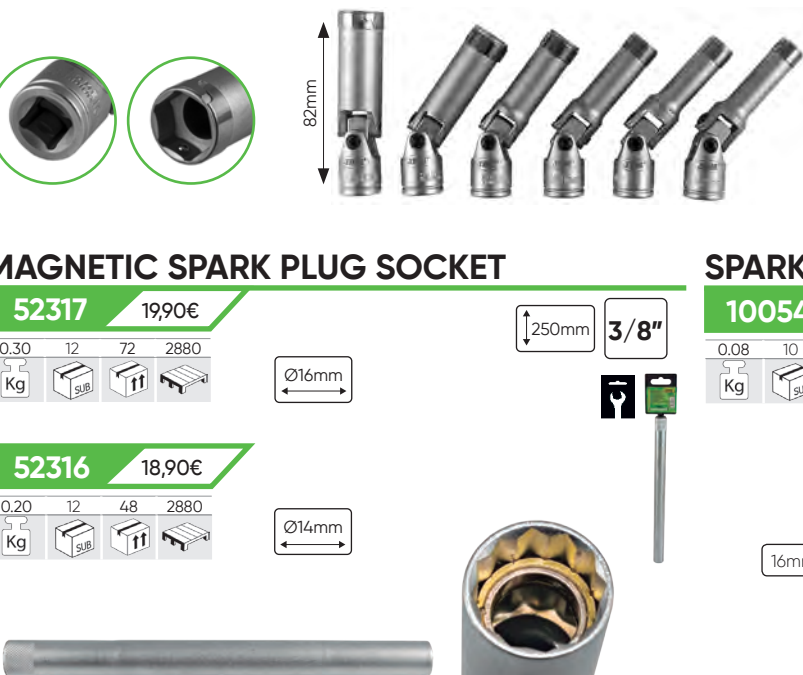

SPARK PLUG SOCKET

10054 2,90€ **16mm**

0.08	10	100	-
Kg	SUB	↑	↑

10055 3,90€ **21mm**

0.14	10	100	-
Kg	SUB	↑	↑

1/2"

RUBBER INSIDE



30 PIECES ALTERNATOR PULLEY TOOL KIT

52293 98,00€

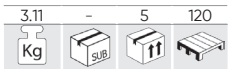

- 1/2" T50 c/33 teeth 19mmX33T - 110mmL.
- 1/2" M10 c/33 teeth 19mmX33T - 110mmL.
- H15x33 teeth 15mmx33T - 30mmL.
- H22x33 teeth 22mmx33T - 30mmL.
- H22 - H22 - 30mmL.
- H17x4 Pins special H17x4Pins- 30mmL.
- 1/2"Dr. xH10 Bit adapter.
- H8 xH10 Tip 75mmL.
- H10xH10 Tip 75mmL.
- M8xH10 Tip 75mmL.
- M10xH10 Tip 75mmL.
- T40 xH10 Tip 75mmL.
- T50xH10 Tip 75mmL.
- M10XH12 Tip 64mmL.
- Special H22xH28 - 30mmL.

- Special H19xH28 - 30mmL.
- 1/2"Dr.XM10 Tip M10 - 140mmL.
- 3/8"Dr.xM10 c/31 teeth 14mmx31T- 85mmL.
- Special H21xH28 - 30mmL.
- Special H17 - 35mmL.
- Special H38x3Pins-20mmL.
- Special 15mmx33T- 30mmL.
- H10xFH10 x68L 68mmL.
- T50XH12 Bit 64mmL.
- Special H 17 x H 21-30mmL.
- Special H15xH28 - 30mmL.
- 3/8" Adapter x10mm.
- 1/2"Dr.XT50 Tip T50 140mmL.
- 1/2"Dr.XT50 Tip T50 200mmL.
- 1/2"Dr.XM10 Tip T50 200mmL.



30
PCS

18 PIECES ALTERNATOR PULLEY TOOL KIT

51259 58,00€

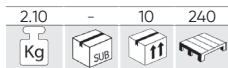

- 3 x twist sockets: T50X113mm, M10X113mm, M10X90mm.
- 1 x toothed socket: M10x140mm.
- 2 x adaptor hex. 19 and 22mm.
- 3 x hex. sockets: 22x28mm, 19x28mm, 21x28mm.
- 1 x Adaptor.
- Hex. 1/2" x 10mm.
- 1 Tip M10x12x64L.
- 6 X Tip 10mm x 75mm;
- Measurements: T40, T50, M8, M10, H8, H10.



18
PCS

SPARE PARTS AVAILABLE



10494 6,50€

EXTENSION SOCKET
14cm



10495 3,00€

TIP H10



10496 3,00€

TIP H8



10497 3,00€

TIP M10



10498 3,00€

TIP M8



10499 3,00€

TIP T40



10500 3,00€

TIP T50



10501 8,10€

SOCKET
XZN TIP M10
90mm

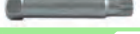

10502 3,50€

M10 TORX BIT

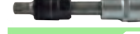

10485 8,10€

SOCKET XZN TIP
M10 110mm

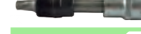

10486 8,00€

SOCKET TORX TIP
T50 110mm

V-BELT TIMING BELT WRENCH SET 12-POINT

52832 75,00€

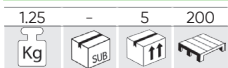

12, 13, 14, 15, 16,
17, 18, 19mm



INTERCHANGEABLE
HEAD

AUXILIARY BELT TOOL SET

52690 54,00€

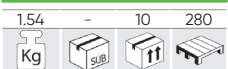

- 230mm lever with 1/2" drive.
- 585mm lever with 3/8" drive.
- 3 wrenches of 13, 14, 15mm and 3/8" square.
- 4 hexagonal sockets of 3/8" square and 13, 15, 16, 18mm.

3/8"

1/2"

1/2" 230mm

3/8" 585mm

UNIVERSAL INNER TIE ROD WRENCH

51368 19,00€

0,41	5	50	1000
Kg	SUB	↑↑	↑↑

∅
↑ 42mm
↓ 33mm



UNIVERSAL INNER TIE ROD TOOL

51369 28,00€

0,55	6	36	756
Kg	SUB	↑↑	↑↑

∅
↑ 42mm
↓ 35mm



STUD HEAVY DUTY EXTRACTOR

51414 14,00€

0,59	5	40	1440
Kg	SUB	↑↑	↑↑

∅
↑ 20mm
↓ 15mm



CAMBER ALIGNMENT TOOLS (VAG)

53488 61,00€

2,75	-	5	200
Kg	SUB	↑↑	↑↑

- Allows one single person adjusting, reducing time.
- Includes:
 - 22mm Hexagonal Spindles.
 - 3 Spindle Lengths:
 - 75mm for Seat - Toledo | VW - Jeta / Golf .
 - 85mm for Seat - Cordoba | VW - Polo / 95>.
 - 115mm for Chrysler - Voyager.



MAGNETIC CAMBER GAUGE

52318 73,00€

0,64	6	24	336
Kg	SUB	↑↑	↑↑

-6° / +6°



HARMONIC BALANCER PULLER SET

52624 28,00€

1,25	-	5	450
Kg	SUB	↑↑	↑↑

- Contains:
 - 2 x crew 5/16" of 4".
 - 2 x screw 1/4" of 3".
 - 3 x screw 5/16" of 2".
 - 3 x screw 1/4" of 2".
 - 1 x 5" precession screw aluminium alloy.



RIBBED DRIVE PULLEY PULLER

51500 29,00€

1,55	-	10	640
Kg	SUB	↑↑	↑↑

40-168mm

- Suitable for use in crankcases, alternators, air conditioning units and water pumps.
- The low profile arms allow easy access to the difficult areas of the engine.
- Designed for removal of ribbed, obstructed crankcases and auxiliary pulleys.
- Rang: 40-160mm.



UNIVERSAL PULLEY PULLER

53664 38,00€

0,80	-	10	2500
Kg	SUB	↑↑	↑↑

- Universal use.
- Multi position to fit most sprockets.
- Ideal for use in tight areas.
- Time saver.



CLUTCH TOOL SPECIALLY FOR FIAT

52190 8,00€

0,39	-	10	1000
Kg	SUB	↑↑	↑↑

220x110mm

Simplifies the access to the fork for removes of it and next disk substitution. Length: 22cm, Width: 11cm. Thread: 1,5 length x 0,5cm diameter. Specifications: Tool to dismantle the clutch fork in Fiat Ducato.



3 PIECES SEAL REMOVING HOOK SET

53053 12,00€

0,21	10	50	1000
Kg	SUB	↑↑	↑↑

1x15.5cm / 1x16.5cm / 1x12cm



SUSPENSION ARM LEVER

51902 84,00€

4,90	-	1	66

- Measurements:
Length: 118cm.
Ø Diameter Tube: 3.5 cm.
Brace distance:
50, 45, 40, 35, 30 cm.
Fastening support: 15 x 13 cm.



FASTENING SUPPORT REPLACEMENT FOR REF. 51902
10953 12,50€



STEERING RACK KNUCKLE TOOL SET

52639 123,00€

5,05	-	4	84

Ø 30-35mm
Ø 35-40mm
Ø 40-45mm



WHEEL ALIGNMENT TOOL

51991 48,00€

1,15	-	10	120

- Total open length: 1950 mm.
- Total closed length: 1100 mm.
- Screw measurement: M6 x 15mm.
- 20 x 20 aluminium exterior tube.
- 16 x 16 zinc plated iron interior tube.

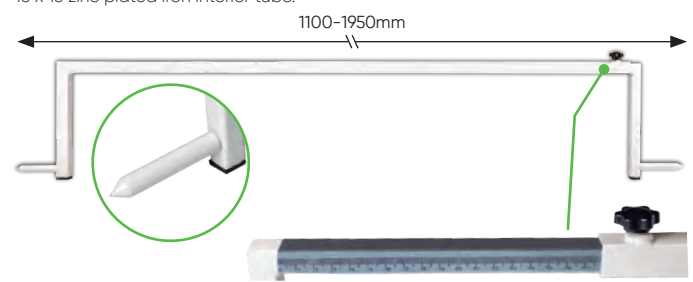

RACK END REMOVER AND INSTALLER

52640 52,00€

1,80	-	4	256

Ø 28-35mm

52641 55,00€

2,20	-	4	140

Ø 35-45mm



TRACK ROD ADJUSTING WRENCH

52874 82,00€

1,20	4	20	1500

Ø 9-20mm

52875 79,00€

1,25	5	20	1500

Ø 14-23mm



12 PIECES AIRBAG REMOVAL SET

51501 38,00€

0,88	5	20	240

- 0.5 PC 1/4" x 87 mm tips (L):
2x Torx: T25 (for BMW), T30 (for Audi, Opel, Renault, VW).
2x Torx (tamperproof): T25H (for BMW), T30H (for AUDI, BMW, Mercedes, Opel).
1x Hex: 5 mm (for AUDI).

- 0.7 PC puller tool:
1x for driver airbag. 1999-2004 new body style for VW Passat, JETTA, GOLF.
2x for VW Passat B5, POLO, LUPO; AUDI A4, A6, Skoda Superb.
2x for VW GOLF 4, New Beetle, SEAT, SKODA FABIA, AB Oktavia BJ.99.
1x for VW GOLF 4 (BJ, 1998-2004), VW PASSAT BJ.1997 AB, AB BORA BJ.1999.
1x for U.A VW MODEL: AB PASSAT BJ.2000.

12 PCS



HYDRAULIC BALL JOINT SEPARATOR

53384 165,00€

7.30	-	2	74
Kg	sub	ff	tr



- Overture: 100mm.
- Width: 35mm.

10kg



1 1/2"-16UNF

M20X1.5



HYDRAULIC SPINDLE

15253
62,00€

5 PCS BALL JOINT SEPARATOR SET

51123 91,00€

5.29	-	2	136
Kg	sub	ff	tr



- Set of versatile pullers.
- This system allows easy removal of the most popular types of ball socket and other joints.
- The type of joint press separator allows removal of the ball socket joint without damage to the loaders and other pieces that can be caused by other types of pullers.

5 PIECES FORK TYPE BALL JOINT SPLITTER SET

51490 36,00€

1.88	-	5	300
Kg	sub	ff	tr

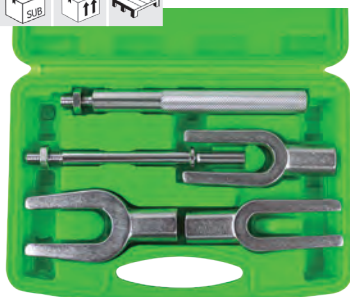

- Yokes made of high resistance chromium vanadium forged steel.
- Both handles are interchangeable.
- 1 handle designed for use with pneumatic hammer.
- Contains: 1 handle for use with a hammer. 3 yokes: 11/16, 15/16 and 1-1/8".

SUSPENSION WEAR LEVER

52541 45,00€

2.10	-	10	110
Kg	sub	ff	tr



- Application range: Dome bearings, silent bearings, carrier joint, track rod end, coupling rod, wheel bearings, axial joint, steering gear, stabilizer, etc.

SCISSOR TYPE BALL JOINT SEPARATOR

52642 32,00€

1.32	5	20	600
Kg	sub	ff	tr

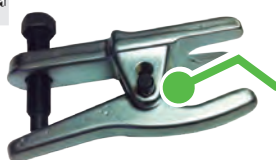

2 ADJUSTABLE SIZES

- Max Opening: 60mm.
- Min Opening: 20mm

17 - 22mm

SCISSOR TYPE BALL JOINT SEPARATOR

52699 22,00€

0.80	5	30	1050
Kg	sub	ff	tr



- Opening: 15-50mm.

Ø 18-22mm

BEARING SEPARATOR AND PULLER SET

51125 88,00€

4.72	-	5	160
Kg	sub	ff	tr

Guillotine capacity:

- 1/4" set: with 30 mm and 50 mm. 3/8" screw 9.5 x 125 - 24 UNF.

- 2 inch set: 1/4" to 3-1/2", 50 x 75 mm. 1/2" screw 12.7 x 135 - 20 UNF. Head 3/8" x 16 UNC.



BEARING SEPARATOR

52626 46,00€

3.65	-	5	800
Kg	sub	ff	tr

75 - 105mm

52627 120,00€

6.50	-	2	231
Kg	sub	ff	tr

105 - 150mm

- To remove wheel bearings in cars and commercial vehicles.
- Easy use to extract gearboxes, car pulleys and steering wheels.



BIT SOCKET XZN SP. VAG

12029 5,50€

0.17	5	100	1500
Kg	sub	ff	tr

TAMPER PROOF
M16X58MM



12030 6,50€

0.25	8	80	-
Kg	sub	ff	tr

TAMPER PROOF
M16X100MM



CrV

1/2"



2/3 LEGS UNIVERSAL PULLER SET

53701 188,00€

8,45 - 1 44

Kg SUB

13
PCS

- 2-leg extractor range: 45-120mm.
- 3-leg extractor range: 50-130mm.
- Clamping depths: 100, 200, 250mm.

- Contains:
- Central guide for 3 claws.
- Central guide for 2 claws.
- Stud bolt: 275mm.
- Stud bolt: 165mm.
- Long grip claws: 250mm.
- Medium grip claws: 200mm.
- Short grip claws: 100mm.

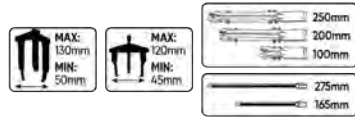

CLAW TIP FOR REF. 53701

14611 0.10 50

12,00€ Kg

SCREW FOR REF. 53701

165mm

14612 0.15 20

11,00€ Kg

SCREW FOR REF. 53701

275mm

14613 0.30 20

13,50€ Kg

INTERNAL BEARING PULLER SET

51124 88,00€

3,20 - 5 120

Kg SUB

- Contents:
- Universal puller (38,5mm).
- 3/8" to 1/2" adapter (10-14 mm).
- 9/16" to 11/16" adapter (15-19 mm).
- 5/8" to 1" adapter (18-25 mm).
- 1" to 1-1/4" adapter (25-32 mm).



TERMINAL EXTRACTOR WITH 6 CONNECTORS

54112 18,00€

0,04 20 100 1800

Kg SUB

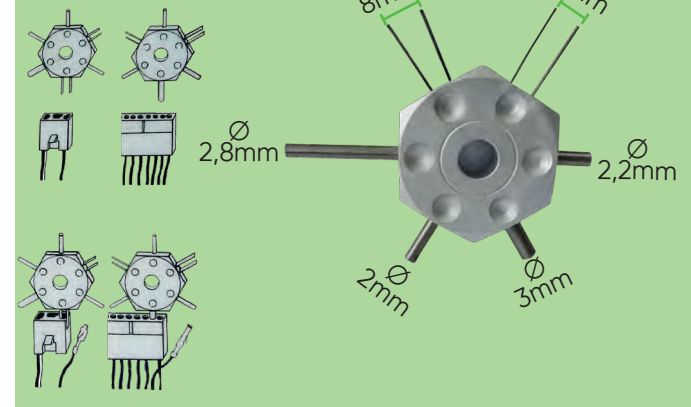

INTERNAL AND EXTERNAL UNIVERSAL BEARING PULLER SET

53250 85,00€

4,80 - 4 72

Kg SUB

- Contents: Chrome molybdenum SD45C.
- For VW / Audi DIESEL.
- Applications: 1.4 SDI / TDI; 1.9 D / SDI / TDI / TDI (PD); 2.0 TDI (PD) & (PD 4-VALVES); 2.5 TDI / TDI (PD); 2.8 TDI (PD) 2.7; 3.0 TDI (Common Rail); 4.2 TDI (Common Rail).

- Material: hardened carbon steel.
- External pulling 40 to 80 mm.
- Internal puller 50 to 150 mm.

- Including:
- Triple leg gear wheel puller.
- Triple leg int. ball-bearing puller.
- 1 deep puller.
- 1 convex screw connection.



BALL BEARING PULLER KIT WITH BALL ENDED PULLER ADAPTER

53062 99,00€

2,41 - 10 160

Kg SUB

5, 6, 8, 9, 11, 12.5mm



TWIN LEG PULLERS

52727 34,60€

0.20	10	60	1200
Kg			

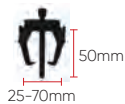

52728 68,00€

1.20	5	10	500
Kg			

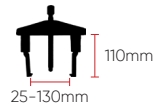

52727



TWIN LEG PULLER DISPLAY

53146 30,50€

0.70	5	10	140
Kg			



52729 128,00€

3.39	-	3	240
Kg			

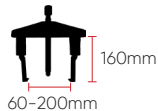

52730 288,00€

8.57	-	2	108
Kg			

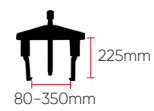

52728

52729

52730

- Pullers not included.

TRIPLE LEG REVERSIBLE PULLER

52731 38,00€

5.30	4	24	504
Kg			

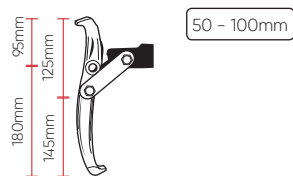

52732 58,00€

2.54	5	20	200
Kg			

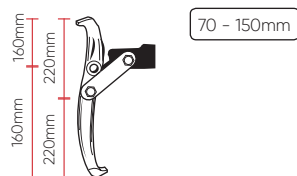

52733 98,00€

5.20	-	4	112
Kg			

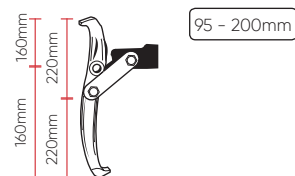

TWIN / TRIPLE LEG BAR TYPE PULLERS

52010 80,00€

0.50	4	40	360
Kg			

- Claw measurement: 90mm.
- Pin measurement: 124mm.
- Grip pawl: 12mm.
- Cross width: 66mm.
- Depth: 75mm.



52296 119,00€

1.57	4	8	120
Kg			

- Claw measurement: 132mm
- Pin measurement: 217mm.
- Grip pawl: 14mm.
- Cross width: 95mm.
- Depth: 110mm.



52298 177,00€

2.65	3	6	396
Kg			

- Claw measurement: short 134mm, long 207mm.
- Pin measurement: 218mm.
- Grip pawl: short 13mm, long 15mm.
- Cross width: 95mm.
- Depth: 110 - 180mm.

SHORT AND LONG CLAW



52297 172,00€

3.33	-	6	36
Kg			

- Claw measurement: 210mm.
- Pin measurement: 313mm.
- Grip pawl: 15mm.
- Cross width: 152mm.
- Depth: 180mm.



52 PCS RADIO RELEASE TOOL KIT

53388 90,00€

1.50	-	5	120
Kg			

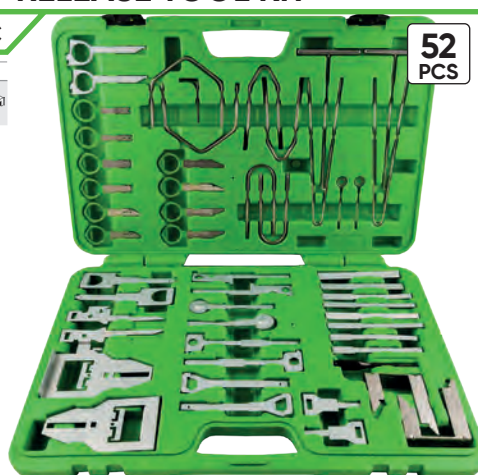

52
PCS

RADIO REMOVAL TOOL SET

51126 18,00€

0.20	10	100	1500
Kg			



10
PCS

- Blaupunkt, Clarion, Skoda, BMW, Audi, Grundig, JVC, Pioneer, Volkswagen, Mercedes, Opel Doppel-Kugel-Inbus, Porsche, Becker, Kenwood, Sony, Panasonic, Fiat Brava, Ford.

- Blaupunkt, Peugeot, Clarion, Skoda, Alpine, BMW, Opel, Audi, Grundig VDO, JVC, Pioneer, Volkswagen, Mercedes, Porsche, Renault, Becker.

23 PCS TERMINAL TOOL SET

53393 118,00€

23
PCS

1,60	-	5	90
Kg	Sub	ff	ff



- BMW, Audi, Volkswagen, Mercedes, Opel, Porsche, Jaguar, Saab, Seat, Ford, Skoda, Renault, Citroën, Chrysler, Fiat, Honda, Mazda, Mitsubishi, Toyota.

19 PCS TERMINAL TOOL SET

53391 86,00€

19
PCS

0,55	-	10	-
Kg	Sub	ff	ff



SUSPENSION BUSH TOOL SET VAG

52432 35,00€

1,80	-	5	300
Kg	Sub	ff	ff

- Special for VW Polo 2002.

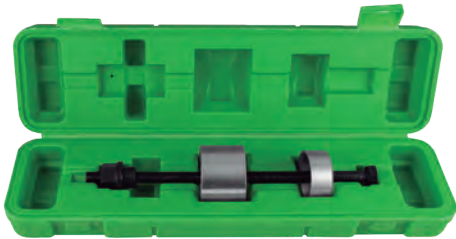

SILENT BLOCK PULLER VAG

52270 109,00€

3,18	-	4	96
Kg	Sub	ff	ff

- Contents:
Mounting adaptor for mechanic spindle, shoulder nut, spindle extension M10x1.25.
Spacer.
Press piece.
Press piece insertion.
Centering ring.



BALL JOINT SOCKET SET (AUTER TYPE)

52834 195,00€

- Socket kits to extract ball bearing nuts in industrial vehicles.

11
PCS

1/2"

CR-MO

mm
22x3.3
26x3.8
30x4.3
33x4.0
37x4.8
44x5.3
50x5.8
56x5.8
63x6.3
69x6.8
75x6.8

3,65	-	2	96
Kg	Sub	ff	ff



BALL JOINT SOCKET SET (INNER TYPE)

52835 272,00€

- Socket kits to extract ball bearing nuts in industrial vehicles.

10
PCS

1/2"

mm
26x5.3
1.2x6.25
34.2x6.3
42.2x7.3
50.1x8.25
58.2x9.8
74.6x11.9
82.2x13.25
87.7x13

5,20	-	3	1500
Kg	Sub	ff	ff



UNIVERSAL BUSH AND BEARING REMOVAL TOOL SET

52494 227,00€

17.35 - 1 48
Kg SUB ff



- Master press and Pul Sleeve Kit.
- For the removal and installation of bushes / bearings and seals, etc.
- Universal applications on both cars and light commercial vans.
- Measurements: M10, M12, M14, M16, M18.

12926 21,50€ M10



12927 21,50€ M12



12928 22,00€ M14



12929 23,00€ M16



12930 23,50€ M18



BEARING RACE AND SEAL DRIVER SET

53058 193,00€

8.19 - 1 102
Kg SUB ff



220mm Ø 12mm

Ø
18, 19, 20, 21, 22, 23, 24,
25, 26, 27, 28, 29, 30, 31,
32, 33, 34, 35, 36, 37,
38, 39, 40, 41, 42, 43,
44, 45, 46, 47, 48, 49,
50, 51, 52, 53, 54, 55,
56, 57, 58, 59, 60, 61, 62,
63, 64, 65, 74mm

FRONT WHEEL BEARING TOOL KIT

53056 127,00€

8.32 - 2 64
Kg SUB ff

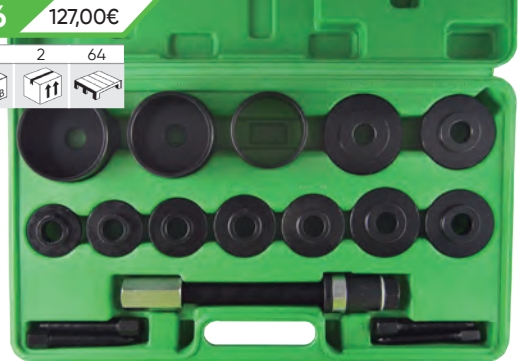

Ø 55.5, 59, 62, 65, 66,
71.5, 73, 78, 84mm

Ø 75.5, 83mm

295mm Ø 69mm

BEARING AND BUSHING INSTALLATOR DRIVER SET

51349 37,30€

1.00 - 10 180
Kg SUB ff

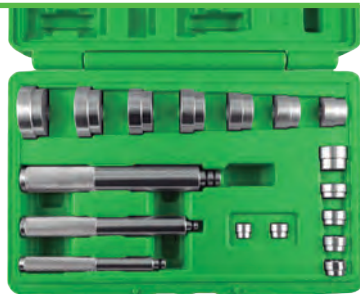

42 - 38mm
40 - 35mm
36 - 32mm
30 - 28mm
24 - 22mm
27 - 25mm
18 - 16mm
20 - 18mm
22 - 20mm
12 - 10mm
14 - 12mm
16 - 14mm
17 - 15mm

- Grooved nut maintenance adapters.
- Suitable for all types of spark plugs and bearings.
- Measurements: from 10mm to 42mm

BEARING RACE AND SEAL DRIVER

53129 84,00€

0.96 2 10 180
Kg SUB ff

18 - 90mm



WHEEL BEARING REMOVAL/INSTALLATION TOOL KIT

52551 151,00€

10.42	-	2	58

- Sleeves: 76, 82, 92, 101mm
- Bolt: 27mm
- Nut: 32mm
- Heavy weight drive screw for use with impact tools
- This set reduces the chance of damage to hub and bearing
- Heavy-duty steel drifts, phosphate coating prevents corrosion
- Also suitable for removing and installing large industrial bearings



Number	955-08	955-11	955-07	955-12	955-13	955-14	955-09	955-15	955-06	955-17	955-18	955-19	955-16
Diameter (mm)	55.7	63.3	67.8	70.7	71.9	71.7	72.8	73.4	74.7	77.4	81.4	83.3	88.4

ALUMINIUM BEARING RACE & SEAL DRIVER SET

53059 52,00€

1.70	5	10	160

∅
39,5, 44,5, 50, 59, 63,
65, 72, 76, 81mm



WHEEL HUB AND BEARING MASTER KIT

54299 227,00€

15,00	-	1	-



	8,6x10,9cm		8,9x17,6cm
	8,2x10cm		9,9x 17,6cm
	7,1x9,45cm		12x17,8cm

∅ 2,3mm

5,3cm	5,8cm	6,5cm	6,6cm	6,8cm
7,1cm	7,3cm	7,8cm	8,3cm	
	∅ 2,3cm		∅ 8,6cm	
9,5cm		9,55cm		

19
PCS



2,4x28cm

CV JOINT PULLER

51364 26,00€

2,00	-	5	280

∅
31mm 140 - 240mm



CRANKSHAFT GEAR AND PULLEY PULLER

51140 64,00€

1,02	-	24	290

- Designed to hold the pulley of the camshaft still while it is loosened.
- Allows adjustment of the central shaft when they are connected.
- Using the centred screwed bar to pull up the pulley.
- Lockscrews: M6, M8.



14 PCS STUD HUB CLEANER SET

54069 29,50€

0.20	10	40	360
Kg	Sub	Box	Tray

Removes surface dirt and corrosion on hubs fitted with Studs.

- 1PC 1/2" Sq 8mm socket driver adaptor.
- 1PC grinding wheel with round drive shaft hex 8mm.
- 2PC replacement hook and loop pads with self-adhesive back.
- 5PC coarse-grained cleaning discs, outer diameter 40 mm.
- 5PC fine-grained cleaning discs, outer diameter 40 mm, inner diameter 14mm.



HYDRAULIC WHEEL HUB PULLER WITH HAMMER SET

53638 243,00€

13.35	-	1	32
Kg	Sub	Box	Tray

- This set includes 3 pullers / hammers: hydraulic spindle, screw, impact hammer specially designed to simplify the removal of the wheel hub and release the drive shaft without any damage.
- For manual or hydraulic extraction.
- Hydraulic spindle with 10 ton maximum capacity.
- 4kg hammer.
- Bar length: 57cm.
- Suitable for: 3, 4, 5 and 6 holed hubs.



VAG (VW, AUDI, SEAT, SKODA), PSA (CITROËN, CITROËN DS, PEUGEOT), RENAULT, FORD, OPEL, BMW, MERCEDES BENZ

HYDRAULIC SPINDLE

15253 62,00€

WHEEL BEARING PULLER WITH SLIDING HAMMER

53635 85,00€

6.50	-	2	80
Kg	Sub	Box	Tray

440 - 630mm

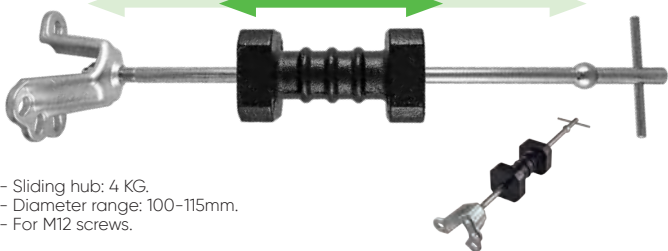

- Sliding hub: 4 KG.
- Diameter range: 100-115mm.
- For M12 screws.

MUFFLER TAIL AND EXHAUST PIPE EXPANDER SET

52637 48,00€

3.01	-	5	220
Kg	Sub	Box	Tray

1-1/8" - 1-3/4"
1-1/2" - 2-1/2"
2-1/8" - 3-1/2"



2 PCS EXHAUST RUBBER HOOK SET

52849 8,50€

0.22	10	40	480
Kg	Sub	Box	Tray



WIPER ARM PULLER SET

53463 98,00€

1.65	-	10	180
Kg	Sub	Box	Tray

- VW:** Polo, Lupo, Touareg, Porsche Cayenne.
- Opel:** Astra G, Zaphira B, Corsa C, Vectra C.
- Honda:** Jazz, CRV, FRV, Accord, Turnier.
- BMW:** 5th Model from E 39 to 2005. 7th Model from E 38 to 2005.
- Audi:** A3, A4, A5, A6. Audi Q7.
- Ford:** Galaxy, Alhambra.
- Mercedes:** A-Class, B-Class.



WINDSHIELD WIPER PULLER

52454 12,90€

0.20	6	36	1152
Kg	Sub	Box	Tray



- Brass cap and thin arm design help prevents damage to the car, painting or glass.
- Heavy duty for loosening the tightest of components with no damage to the wiper arms.
- Suitable for most vehicles and vans.



200NM TORQUE WRENCH WITH INTERCHANGEABLE HEAD

52913 292,00€

- Include factory calibration certificate.

1/2"

3,94	-	4	128
Kg	sub	ft	ft

- Torque: 40-200Nm.
- Heads included: Spanners: 13, 14, 15, 17, 19, 22, 24, 27, 30mm.
- 1/2" Ratchet head.
- Different heads available separately.

18x14mm



RATCHET TORQUE WRENCH

- Include factory calibration certificate.

53081 115,00€

1,10	5	25	350
Kg	sub	ft	ft

1/4"

4-20NM (36T)

375mm



53082 148,00€

1,90	4	8	168
Kg	sub	ft	ft

1/2"

40-210NM (24T)

560mm



RATCHET TORQUE WRENCH

51262 51,00€

270mm

2-24 Nm
0,2 - 2,4 M. Kg

1/4"

0,80	4	16	384
Kg	sub	ft	ft



51338 53,00€

365mm

19-110 Nm
1,9 - 11 M. Kg

3/8"

1,05	4	16	320
Kg	sub	ft	ft



51127 56,00€

470mm

28-210 Nm
2,9 - 21,4 M. Kg

1/2"

1,70	4	8	256
Kg	sub	ft	ft



- Include factory calibration certificate.

53972 550,00€

8,75	-	2	42
Kg	sub	ft	ft

3/4"

1000-1.210mm

200-800 Nm
21,4 - 81,6 Kg

SMC44



REPAIR KITS

51262R 14,00€

0,05	20
Kg	ft



51338R 14,00€

0,05	20
Kg	ft



51127R 14,00€

0,15	20
Kg	ft



VAT not included

TORQUE SCREWDRIVER WITH WINDOW SCALE SET

51830 94,00€

- Include factory calibration certificate.

1,00	-	12	300
Kg	sub	ft	mm

- Exactness: CW: +/- 4%
- Operation range: 2-10 N-m
- Selection units: N-m, in-lb.
- Length (mm): 242
- Die: 1/4"
- Useful life: 100.000 cycles



DIAL TEST INDICATOR GAUGE SET

52904 61,00€

2,00	-	5	200
Kg	sub	ft	mm

- Measurement: 0-10mm.
- Calibration: 0.01mm.
- Sphere: 58mm.
- Magnetic Base: 40kg.

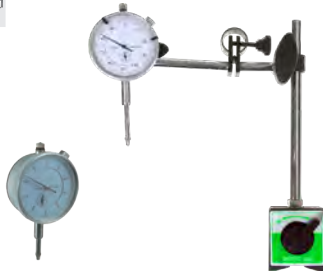

DEPTH GAUGE FOR REF. 52904

13704 21,00€

0,10	-	50	1500
Kg	sub	ft	mm

TORQUE MULTIPLIER SET 3/4" (F) + 1/2" (M)

51958 422,00€

4,35	-	4	96
Kg	sub	ft	mm

- Characteristics:
- Transmission ratio 1: 4.
- Torque ratio: 1: 3.3.
- Maximum input torque: 303 Nm.
- Maximum output torque: 1000 Nm.



- Contents:
- 1x torque multiplier.
- 1x manual ratchet.
- 1x 1/2" M x 3/4" F adapter.
- 1x release kit.
- 1x 90° extension bar.
- 1x 350 mm extension bar.

TORQUE ANGLE GAUGE 1/2"

52583 8,50€

0,20	4	48	864
Kg	sub	ft	mm



TORQUE ANGLE GAUGE WITH MAGNETIC ARM 1/2"

52794 28,00€

0,48	6	24	288
Kg	sub	ft	mm



- Useful for tightening screws according to specifications determined by the manufacturers of vehicles and machinery.
- Tighten made by ratchet or 1/2" torque wrench.
- Transparent window for a correct view of the measurement.
- Measuring range 0 to 360.
- Fixation of the goniometer by magnetic arm for proper fixing before use. The magnet system allows to use the tool in a simply and securely way.

20 METRIC BLADE FEELER GAUGE

52433 4,80€

0,10	10	50	1000
Kg	sub	ft	mm

0,05 - 1mm



VERNIER CALIPER

50937 10,50€

0,24	10	50	1500
Kg	sub	ft	mm



50724 28,00€

0,30	5	50	1200
Kg	sub	ft	mm



DIGITAL TYRE TREAD DEPTH GAUGE

53042 9,90€

0,05	10	100	2000
Kg	sub	ft	mm

0-25.4mm

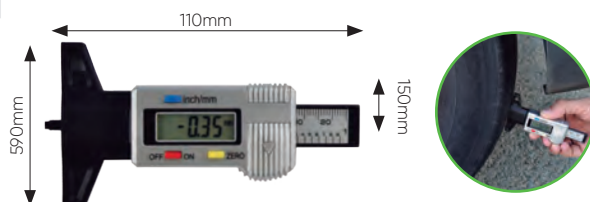

TYRE TREAD DEPTH GAUGE

52873 11,00€

0,04	5	300	1500
Kg	sub	ft	mm

0-40mm



TORQUE MULTIPLIER WITH EXTENDER

51919

89,00€

7,75	-	3	120
Kg	SUB	1f	1f

- Material: 40 CR.
- Maximum power: 5800 Nm.
- Work power: 3800Nm.
- Multiple in range 1: 56.
- Includes 32mm and 33mm 1" sockets.



TORQUE MULTIPLIER SET

52796

98,00€

8,88	-	3	72
Kg	SUB	1f	1f

6.000Nm

- Prevents rim damage.
- Easy adaptation to any universal vehicle.
- Useful for effortless screwing and unscrewing.

- Includes:
1x socket 1" 32mm.
1x socket 1" 33 mm.



CAR TORQUE MULTIPLIER SET

52012

68,00€

2,34	-	4	128
Kg	SUB	1f	1f

- Contents:
1x torque multiplier.
1x 90° extender bar.
Sockets 17 mm, 19 mm and 21 mm.



PRIVATE CAR

1/2"

- Multiple range: 1: 18.
- Maximum output torque: 360Nm.
- Maximum tightening torque: 800Nm.



8 PIECE SOCKET SET FOR TORQUE MULTIPLIER

52056

66,00€

5,45	-	4	128
Kg	SUB	1f	1f

22, 24, 27, 30, 32,
33, 38, 41mm

CrV

1"

8
PCS

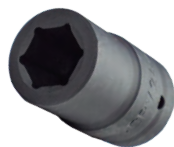

SPARE PARTS AVAILABLE

REF.	DESCRIPTION	Kg	1f	€
10672	32mm	0,58	1	9,50€
10673	33mm	0,58	1	9,50€
10674	27mm	0,54	1	9,50€
10675	30mm	0,54	1	9,50€

CLUTCH COMPRESSOR MASTER SET

53001 242,00€

905	-	1	40

- Clutch deformations are avoided using the pretensioner.
 - Using the Reset Tool, we will bring the reset ring of the pressure plate to the new position when mounting a new clutch valve.
 - Suitable for almost all clutches SAC (Automatic Adjust Clutch).

- Advantage:
 Clutch pressure plate tensioning in the assembly and disassembly
 Reposition spring adjustment with reset tool.
 Center of the valve with respect to the guide bearing.

- Content:
 Clutch Pretensioner.
 3-hole center.
 Reset tool.
 Centering set.
 4 hole center.



FOR:
 VW
 Audi
 Bmw
 Mercedes
 Volvo
 Renault
 Opel

UNIVERSAL CLUTCH ALIGNING SET

53410 92,00€

1,60	-	5	230



- Centering diameter:
 15-19 / 20-26,6 / 23-36mm
 - Accessories diameter:
 12, 14, 15, 16, 17, 18, 19, 20mm



DSG CLUTCH TOOL SET - VAG

53057 149,00€

5,55	-	2	120

- For service in DSG changes in Golf (2004-), Golf Plus (2005-), AUDI A3 (2004-) with 7-speed transmissions code 0AM, and in Touareg (2003-) with 6-speed transmission code 08D).
 - OEM References of Tools: T10323, T10373, T10374.



10 PIECES 1/2" SPECIALIST AUTOMOTIVE IMPACT SOCKET SET

53669 45,00€

0,70	5	20	1080



TOYOTA, NISSAN, RENAULT, OPEL ASTRA G / ZAFIRA, SMART, CITROËN, PEUGEOT, HONDA CIVIC

CONTAINS

	10S Toyota idler gear center fixings		14 mm Smart car, Astra G and Zafira brake calliper mounting plate fixings
	6S Nissan and Renault clutches, cylinder heads and balance shaft fixings.		10 mm Nissan brake and fuel pump fixings
	8S Nissan and Renault clutches, cylinder heads and balance shaft fixings.		12.5 mm Nissan brake and fuel pump fixings
	12S Nissan and Renault clutches, cylinder heads and balance shaft fixings.		19 mm Peugeot, Renault and Citroen brake calliper mounting plate fixings
	8TS Nissan balance shaft fixings		20 mm Honda Civic lower control arm bolts



UNIVERSAL PLASTIC CLUTCH ALIGNMENT TOOL

52495 14,50€

0,25	4	48	384



- Aligner tool for most of the vehicles.
 - Includes 3 diferents adapteurs of diferent diameters.



SPECIAL TOOLS

AIR CONDITIONING DIAGNOSTIC GAUGE SET (BAR)

53456 98,00€

BAR

2.90	-	5	75
Kg	Sub	ff	ff

- Test for variations in high and low pressure sides of vehicle air conditioning systems.

- Light-weight, aluminium block design with sight glass and easy-to-read large anti-flutter gauges.

- Professional service couplers (colour coded and labelled).

- Three colour-coded charging hoses and a hanging hook to allow hands-free use.

- Applications: R134a, R12.

- Hose Length: 1550mm.

- High pressure: 0-34 BAR.

- Low pressure: 0-24 BAR.

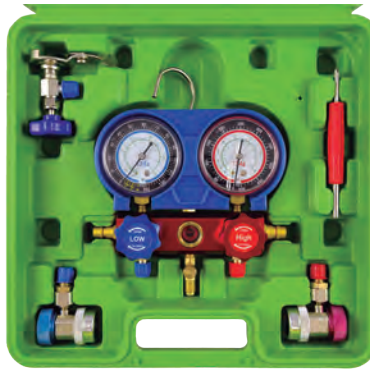

QUICK COUPLER FOR HIGH PRESSURE (REF.53456)

14300 19,00€

0.20	100
Kg	ff

R-134a



QUICK COUPLER FOR LOW PRESSURE (REF.53456)

14301 19,00€

0.20	100
Kg	ff

R-134a

1234YF GAS ADAPTER

HIGH

53499 29,00€

0.30	15	60	2400
Kg	Sub	ff	ff



R1234YF Quick connect refrigerant air conditioning Adapter. Red (high pressure). The quick connect design has an integral safety. Sleeve which protects against injury and refrigerant loss if the coupler is disconnected under pressure. Uses: air conditioning and refrigeration.

Material: Brass & metal
Color: Red, blue
Size: Height 55mm, Diameter 30mm
Weight: 194g

LOW

53500 29,00€

0.20	15	60	2400
Kg	Sub	ff	ff



CAR AIR CONDITIONING SCHRADER VALVE CORE SET

53599 30,30€

0.16	10	100	-
Kg	Sub	ff	ff



134
PCS

R12 5mm L: 19mm	R12 6mm L: 19mm	R134A 7mm L: 20mm
R12 5mm L: 19mm	R12 6mm L: 22mm	R12 8mm L: 22mm
R12 5mm L: 19mm	R12 6mm L: 26.5mm	R12 9mm L: 22mm



SPARE PARTS AVAILABLE

REF.	SIZE	Kg	ff	€/u.
14594	5x19mm R12 (GREEN)	0,01	10	2,00€
14595	5x19mm	0,01	10	1,50€
14596	5x19mm R12	0,01	10	2,00€
14597	6x19mm	0,01	10	7,60€
14598	6x26.5mm	0,01	10	17,80€
14599	7x20mm R134A	0,01	10	4,50€
14600	6x22mm	0,01	10	9,50€
14601	8x22mm	0,01	10	11,00€
14602	9x22mm	0,01	10	11,00€

AIR CONDITIONING RUBBER O-RING ASSORTMENT

50807 38,00€

0.16	6	24	672
Kg	Sub	ff	ff



HNBR **270**
PCS

5.29x1.78mm 20 PCS	6.07x1.78mm 20 PCS	6.8x1.9mm 20 PCS	7.65x1.78mm 20 PCS	7.80x1.90mm 20 PCS	8.0x2.0mm 20 PCS
8.80x1.90mm 20 PCS	10.82x1.78mm 15 PCS	10.77x2.62mm 15 PCS	11.0x2.0mm 15 PCS	12.0x2.0mm 15 PCS	13.9x1.80mm 10 PCS
13.95x2.62mm 10 PCS	14.0x2.0mm 10 PCS	15.0x2.0mm 10 PCS	17.0x2.00mm 10 PCS	17.17x1.78mm 10 PCS	17.04x3.53mm 10 PCS

FUEL AND AIR CONDITIONING HOSE LINE DISCONNECT SET

53459 66,00€

1.05	-	10	150
Kg	Sub	ff	ff



8mm (5/16"),
9.5mm (3/8"),
13mm (1/2"),
16mm (5/8"),
19mm (3/4"),
22mm (7/8")



9.5 mm (3/8"),
16mm (5/8"),
13mm (1/2"),
19mm (3/4")

A/C LEAK DETECTION KIT

53539 78,00€

1.42	-	5	150
Kg	sub	ff	ff



- Set specially designed to detect pressure losses in air conditioning and refrigeration system in an easy way.
- It consists in inserting a neutral fluorescent liquid in the circuit to detect the leak quickly.

- Contains:
1x UV Lamp.
1x UV vision goggles.
1x Batteries rechargeable.
1x Syringe fluid insertion.
1x Quick Adapter.
1x Extension adapter.
1x Charger.



100 Lm	3W	110V 220V	x1 3.7V
--------	----	-----------	---------

FLUID DETECTOR LEAKS FOR AIR CONDITIONING SYSTEM 250 ML



12977	0.33	3	12	480	250ml
36,50€	Kg	sub	ff	ff	

- An application of 7.5 ml for each 1.4 L of coolant.

UV GLASSES FOR 53539

14187	0.05	10	120	1080
6,00€	Kg	sub	ff	ff

RECHARGEABLE BATTERY FOR 53539

15052	0.05	5	10
3,00€	Kg	sub	ff

AA/CC LEAK DETECTION SYRINGE

12200	1.10	50
14,50€	Kg	ff

CHARGER FOR 53539

15054	0.12	5	10
34,00€	Kg	sub	ff

CHARGER FOR 53539

15053	0.08	10
10,50€	Kg	ff

FLEXIBLE COB LED UV WORK LIGHT WITH MAGNETIC BASE

53530 46,00€

0.35	-	20	620
Kg	sub	ff	ff

380mm 45mm

200 Lm	LED 2W COB	5V 1.000MA	3.7V 2.600MAH
4H	4H		

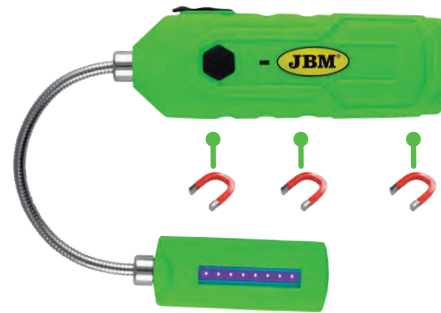

UV



UNIVERSAL RADIATOR PRESSURE TESTER KIT

52687 168,00€

6.70	-	1	24
Kg	sub	ff	ff

- Test range: 0 - 2,5 bar.
- 19 specific radiator tester head gasket.
- 1 universal radiator tester head gasket.



- 1: Pressure pump with discharge valve.
- 2A: Connector 1: Coupling for No.3(R123) and No.4 (R124).
- 2B: Connector 2: Coupling for No. 3(R123) and No. 5(R125).
- 3: Mercedes (W123, W126, W124, W201), GM(Buick), Jeep.
- 4: Peugeot, Subaru, Chrysler, Acura, GM (Nova, Spectrum, Sprint), Mitsubishi, Nissan, Mazda, Toyota, Infiniti, GEO, Suzuki, Isuzu, Mercedes.
- 5: Honda, Toyota, Suzuki, Mitsubishi, Chrysler, Acura.
- 6: Mercedes Benz (ML, W163, W164), GM (Acliva, Skylark, Grand Am 1992-2002.)
- 7: Volvo, Saab, Sterling, Citroen, Renault, Fiat, Alfa, Jeep.
- 8: VW(Vento, T4, Passat-1996, Golf, Beetle, Sharan).
- 9: Audi(A4, A5, A6), BMW 345, VW (Passat -1997-2002), Porsche(Cayenne).
- 10: BMW (E46, E36, E34, E39, E38, E32, E90).
- 11: Audi, VW.
- 12: International, Land Rover, Jaguar.
- 13: Mercedes (C, E, S, W140, W220, W124, W210, W211, W215, W216, W221, R230).
- 14: Ford Focus.
- 15: Mazda(M3).
- 16: Mercedes clase A (W168).
- 17: BMW E60, E63, E64, E65.
- 18: VW SHARAN 1.8T 2.8.
- 19: TOYOTA-RAV4, PREVIA Universal rubber adapter for drain and fill radiators.
- 20: SAAB.
- 21: LAND ROVER.

ENGINE OIL FILLER FUNNEL SET

53485 140,00€

3,00	-	4	40
Kg	Sub	ft	ft

Contents:

- 1- Threaded adaptor M42 x 4.5 for Subaru
- 2- Threaded adaptor M37 x 3.0 (short type) for Lotus, Pontiac, Scion, Toyota
- 3- Threaded adaptor M35 x 4.0 for Ford, Jaguar, Land Rover, Mazda
- 4- Threaded adaptor M32 x 3.5 for Acura, Dodge, Ford, Honda, Jaguar, Jeep, Land Rover, Mazda, Nissan
- 5- Bayonet adaptor for Toyota & Lexus 3.0 & 3.3L V6
- 6- Bayonet adaptor for Audi, BMW, Mercedes-Benz, Porsche, Volvo, VW
- 7- Threaded adaptor M30 x 3.0 for Dodge Cummins
- 8- Threaded adaptor (1/2 turn) for Mazda 3 / 6 / CX-5
- 9- Threaded adaptor (1/2 turn) for Cadillac, Chevy, Ford, GMC, Hyundai, Jaguar, Land Rover, Mazda, Saab, Mercury
- 10- Threaded adaptor (1/4 turn) for new oil filling lids as of 2008 on Audi, Seat, Skoda, VW with EA888 engine
- 11- Threaded adaptor (1/2 turn) for Dodge Hemi 6.4L (2011-) & >3.6L (>2014)
- 12- Threaded adaptor M37 x 3.0 (long type) for Lotus, Pontiac, Scion, Toyota



15
PCS

53347 100,00€

2,75	-	4	36
Kg	Sub	ft	ft

8
PCS



Contents:

- 1- Threaded adaptor M42 x 4.5 for Subaru
- 2- Threaded adaptor M37 x 3.0 (short type) for Lotus, Pontiac, Scion, Toyota
- 3- Threaded adaptor M35 x 4.0 for Ford, Jaguar, Land Rover, Mazda
- 4- Threaded adaptor M32 x 3.5 for Acura, Dodge, Ford, Honda, Jaguar, Jeep, Land Rover, Mazda, Nissan
- 5- Bayonet adaptor for Toyota & Lexus 3.0 & 3.3L V6
- 6- Bayonet adaptor for Audi, BMW, Dodge, Mercedes-Benz, Porsche, Volvo, VW



VACUUM AND PRESSURE TEST SET

54016 76,00€

1,50	-	5	100
Kg	Sub	ft	ft

This kit includes, together with the vacuum pump, a complete set of tips, adapters, plugs, rubbers and gauge for a correct and easy bleeding of the brake system, as well as an easy check.

Maximum pressure: 40psi (3 bar)
Minimum pressure: -20psi (-0.75 bar)



MAX
40 PSI
3 bar

MIN
-20 PSI
-0,75 bar

COMBUSTION GAS LEAK DETECTOR SET

53662 89,00€

1,78	5	10	80
Kg	Sub	ft	ft

- This tool is designed to check for the leaks between combustion and cooling system of water-cooled engines.
- Combustion process produces (beside others) 13-14% CO₂ in the exhaust and the leakage of this gas in the cooling system is easily detected.
- If there are combustion gases, the colour of the test fluid in the upper chamber turns yellow or green, it means combustion gas (CO₂) leak into the coolant.
- The test fluid may NOT be reused.

- It contains: 200ml round bottle. 250ml square bottle.
- Adapters: Small: Suzuki, Toyota, Mitsubishi. Medium: Suzuki, Toyota, Mitsubishi, Subaru, Peugeot, Nissan, Lexus, Mazda. Big: Ford, GM, Benz, JEEP.



COMBUSTION LEAK TESTER FLUID

14563	0,23	5	50
18,00€	Kg	Sub	ft



6 PIECES 1/2" EXTRA LONG E-STAR TORX TYPE SOCKET SET

53915 65,00€

2.10	-	10	240
Kg	sub	ff	ff

E12 Socket for BMW cylinder head:
 - M42 engine, 1.8L, 4 cylinders, 16V, model 318 is from 1989
 - M50 engine, 2.0L, 2.5L, 6 cylinders, 24V, model 520i, 525i from 1991



SATIN FINISH



1/2"

6 PCS

CrV

VALVE SPRING COMPRESSOR REMOVAL TOOL

52693 24,50€

0.65	5	20	450
Kg	sub	ff	ff



- Allow valve spring and valve stem oil seals to be replaced with the cylinder head.
- Tool spring depth reach grips to retainer are adjustable to fit most large and small spring applications.
- For use on a wide range of OHV, OHC, and CHV engines.
- Not suitable for use on engines

with deep steated valves.
 - Features a reversible jaw/ adaptor and automatic cam-action locking to re-determined setting.

VALVE SPRING COMPRESSOR SET

51120 41,00€

2.10	-	5	160
Kg	sub	ff	ff

- Can be used for cars or motorcycles.
- The 5 adapters can be fitted correctly and easily to compress the valve spring.



- Contents:
 Spring compressor.
 Adapters: 30, 25, 23, 19, 16mm.

VALVE SPRING COMPRESSOR 45-145mm

52734 51,00€

2.61	-	5	175
Kg	sub	ff	ff



CYLINDER HEAD COMPONENTS ORGANIZER

53637 85,00€

1.40	-	5	20
Kg	sub	ff	ff

260mm 400mm 450mm

- Special for cylinder head.
- Keeps all components neat and tidy as they come off the cylinder head.
- Saves time and frustration.

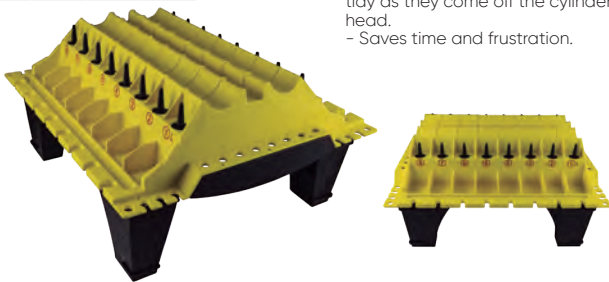

2 PIECE VALVE GRINDER SET

52850 7,80€

0.11	6	72	1008
Kg	sub	ff	ff

Ø 3,49-2,86mm
 Ø 1,59-2,06mm

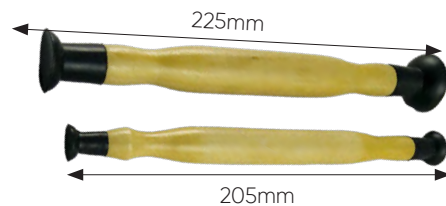

AIR VALVE LAPPER SET - PERCUSSION AND ROTATION

53572 348,00€

1.90	-	5	80
Kg	sub	ff	ff



REGULATES THE SPEED



50	14157	14158	14159	14160	14161
ff	8,30€	9,95€	12,60€	12,80€	13,70€

- Contents:
 1x Valve Lapper.
 5x Suction Pads (16, 20, 30, 35 and 45 mm).
 5x Valve Stem Adaptors.
 1x 3 mm Allen Key.



TURNS RIGHT + TURNS LEFT



1/4"	800BPM	1/4"
50L/min	1.8 CFM	289mm

PISTON RING COMPRESSION SET

53251 88,00€

2.80	-	4	72
Kg	sub	ff	ff



- Complete set of rings and piston rings.
- Plier to install piston rings.
- Tightening of the rings with toothed ratchet system.

H:3"	H:4"	H:6"
Ø 53-125mm	Ø 60-175mm	Ø 60-175mm

PISTON RING COMPRESSOR

52697 16,00€

0.50	5	40	720
Kg	sub	ff	ff

Ø 60-175mm

6"

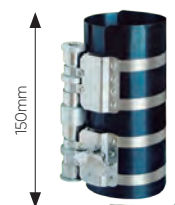

52696 12,00€

0.28	5	40	1200
Kg	sub	ff	ff

Ø 53-175mm

3"

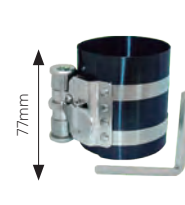

BRAKE CYLINDER HONE

2 ARMS

52591 12,00€

0.10 12 72 1728
Kg SUB ITT

∅ 55mm
19mm

28,6mm

1-1/8"



3 ARMS

52592 22,00€

0.20 - 20 480
Kg SUB ITT

∅ 85mm
35mm

50,8mm

2"



52593 34,00€

0.47 6 36 360
Kg SUB ITT

∅ 170mm
55mm

101,6mm

4"



POLISH PAD 1-1/8" FOR REF. 52591- 2 UNITS ON BLISTER

11878 4,10€

0.10 25 100
Kg SUB ITT



POLISH PAD 2" FOR REF. 52592 - 3 UNITS ON BLISTER

11879 5,10€

0.04 25 100
Kg SUB ITT



POLISH PAD 4" FOR REF. 52593 - 3 UNITS ON BLISTER

11880 10,50€

0.09 25 100
Kg SUB ITT

COIL SPRING COMPRESSOR SET

53394 598,00€

2970 - 1 18
Kg SUB ITT

- Professional kit that allows to quickly remove and install the front and rear suspension springs.

- Telescopic arm and non-slip surfaces that allow a solid grip of the springs.
- Claws equipped with an interchangeable plastic protection to avoid damaging the painting.
- It prevents the springs from bending in compression.
- Universal, covers 90% of the vehicle fleet.

- Content:
Device / piston.
Three pairs of jaws with plastic covers.

300 mm

2 x 65-125MM
2 x 88-160MM
2 x 126-212MM

26.000 Nm
1.050 Kg

Suitable for use with pneumatic tools



39 PIECE SHOCK ABSORBER TOOL SET

53118 231,00€

6.66 - 2 44
Kg SUB ITT

CRV 6140
CRMO
SCM415
CRV 50BV30

39 PCS



SPRING COMPRESSOR FOR DAMPENERS

50827 387,00€

32.90 - 1 15
Kg SUB ITT

- Max load: 1T (2200 lbs)
- Compressed spring diameter: 200mm
- Compression length: 200-500mm



MACPHERSON STRUTS COIL SPRING COMPRESSOR

52227 247,00€

15.10 - 1 36
Kg SUB ITT

- Technic specifications:
Maximum Charge: 2500N.
Principal part.
Extended support.
3 jaw pairs.



- 1st PAIR: USE RANGE: 80-115mm. WEIGHT: 1.45 Kg.
- 2nd PAIR: USE RANGE: 110-195mm. WEIGHT: 2.2 Kg.
- 3th PAIR: USE RANGE: 140-195mm. WEIGHT: 2.3Kg.

- BMW, Toyota, Ford, Mitsubishi, VW, Audi, Saab, Nissan, Honda Accord, Subaru, Volvo, Opel, Porsche.

DO NOT USE WITH AIR IMPACT WRENCH

COIL SPRING COMPRESSOR SET

51121 27,30€

1.80 - 5 420
Kg SUB ITT

- Claws and stud forged with iron-carbon alloy, both heat-treated to ensure you a professional work.
- Tool designed to be used in limited spaces and under the wheel arch, offering the greatest protection.
- Maximum opening 250 mm.

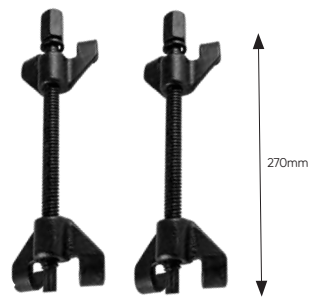

TIMING LIGHT

DIGITAL

- It allows to adjust the ignition in the motors.

53474 94,00€

0.85	5	20	160
Kg	Sub	ff	ff

12V 3,6W 1.8m 0,1° 9.000

53240 58,00€

0.75	-	20	160
Kg	Sub	ff	ff

12V 3,6W 1.5m



2 PLIERS



INDUCTIVE SENSOR



2 PLIERS



INDUCTIVE SENSOR

AUTOMOTIVE ELECTRONIC STETHOSCOPE

53249 192,00€

2.65	-	5	40
Kg	Sub	ff	ff

- Used by noise, harshness and vibration engineers to isolate problem sources.

- Enables vehicle to be road-tested and diagnosed simultaneously.

- Length of sensor cable: 4.8m.

- Super-sensitive stethoscope, suitable for detection of faults in:
Engine, Transmission,
Cat Intake/Exhaust Manifold,
Fuel Injectors, Radiators,
Valves, Fuel Tanks.



- Kit includes:
Audio probe.
Headphones.
Six clip-on microphones.
Six-channel microphone selector box.

TECHNICIAN'S STETHOSCOPE

51347 9,90€

0.14	5	50	400
Kg	Sub	ff	ff

910mm 320mm



- Locates and amplifies internal mechanical and fluid passage noises.

- Locates the source of engine noise rapidly.

- Listens to problems of rational localization of water, petroleum, gas or vapour flows.

- Shockproof handle



Ø 12mm

CONNECTOR DISASSEMBLY TOOL FOR VAG

53663 8,00€

0.01	10	100	4800
Kg	Sub	ff	ff

VAG



- Tool to disassemble connectors in vehicles of the VAG group without damaging them.

HEADLIGHT ADJUSTMENT TOOL SET

53729 19,10€

0.40	10	40	480
Kg	SUB	ff	ff



LOCKING CLAMP FOR HOOD AND TRUNK OPENERS

53525 12,00€

0.10	5	30	1770
Kg	SUB	ff	ff

- Maximum opening diameter: 10mm.



TELESCOPIC EXTENSION POLE

52497 26,80€

0.29	6	48	480
Kg	SUB	ff	ff

↑120mm
↓53mm

53196 33,00€

0.37	6	48	-
Kg	SUB	ff	ff

↑160mm
↓71mm

- To check brake lights.
- To determine the tire pressure.
- To remove small stones from tires.
- To hold the engine cover.

- Strong and light, made of aluminum in 3 sections.

WITH 3 SECTIONS OF ALUMINUM

HARD & LIGHT



DOOR HANDLE REMOVING TOOL VAG

53655 12,00€

0.09	12	96	1152
Kg	SUB	ff	ff



ANGLE DRILL ADAPTOR

52620 8,80€

0.05	6	36	1584
Kg	SUB	ff	ff

37mm



- Bit holder suitable for narrow spaces, extra low profile (37mm), with quick-release function.

- Drill: 6mm.

8 PCS HOSE LOCKING PLIERS SET

53477 36,10€

0.80	-	10	220
Kg	SUB	ff	ff

8 PCS

NYLON 8, 10, 13mm

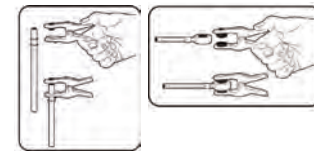

3 PIECE HOSE CLAMP SET

3 PCS NYLON

1/2" 3/4" 5/8"

52066 12,00€

0.28	5	40	480
Kg	SUB	ff	ff

- Made in light material and electrically isolated.
- Use in 1/2", 3/4" and 5/8" sizes.
- Adequate for break, gasoline and freezer circuit.

- 0-20mm
- 0-35mm
- 0-70mm

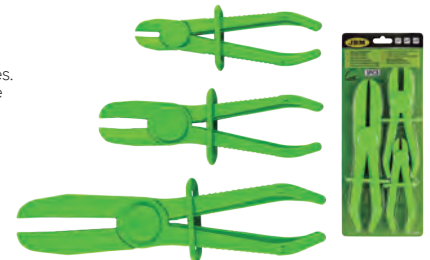

53395 16,00€

0.30	5	20	360
Kg	SUB	ff	ff

Ø 13, 20, 35mm

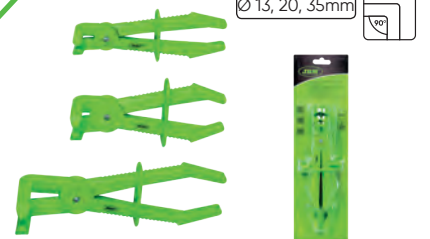

SUPER GRIP FLEXIBLE TOOL TRAY 3PCS SET

53903 59,00€

1,65	-	10	100
Kg	sub	ff	ff

- Non-slip.
- Ideal for all workplace conditions to keep tools within reach.
- Easy to carry.
- Oil resistant.
- Bears temperatures up to 140°C degree.
- Ruler integrated on both sides of the tray.
- Separated compartments to keep tools well

- organized.
- Unique sucking disc for extra grip on flat surfaces.



SMALL TRAY

15010 16,50€

0.40	20	360
Kg	sub	ff

MEDIUM TRAY

15011 18,00€

0.45	20	320
Kg	sub	ff

LARGE TRAY

15012 31,50€

1.05	10	120
Kg	sub	ff

- Small: 285x137x27mm
- Medium: 285x202x27mm
- Large: 543x300x27mm
- Material: soft rubber

FLEXIBLE MAGNETIC TRAY

- Plastic tray flap to hold screws, bolts and small parts.

52516 28,00€

0.42	6	24	1152
Kg	sub	ff	ff

- Top diameter: 225mm.
- Base diameter: 87mm.
- Max depth: 127mm.
- Min. depth: 43mm.

52517 6,00€

0.10	12	72	1152
Kg	sub	ff	ff

- Top diameter: 135mm.
- Base diameter: 53mm.
- Max Depth: 90mm.
- Min. Depth: 31mm.



MAGNETIC TRAY

52466 11,00€

0.43	-	20	180
Kg	sub	ff	ff

Ø 150mm

112mm

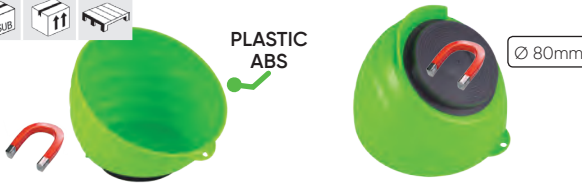

MAGNETIZED ROUND TRAY

50787 8,00€

0.35	6	36	648
Kg	sub	ff	ff



x1 Ø 150mm

50788 14,50€

0.62	6	24	432
Kg	sub	ff	ff



x1 239 x 139mm

MAGNETIC HOLDER

52467 10,30€

0.50	-	24	1008
Kg	sub	ff	ff

- Powerful magnet, padded to avoid damaging surfaces.

40mm 145mm 75mm



MAGNETIC HOOKS FOR PNEUMATIC TOOLS

52378 10,00€

0.36	10	40	720
Kg	sub	ff	ff

3KG Ø 60mm

51341 35,00€

1.62	-	12	96
Kg	sub	ff	ff

9KG Ø 70mm

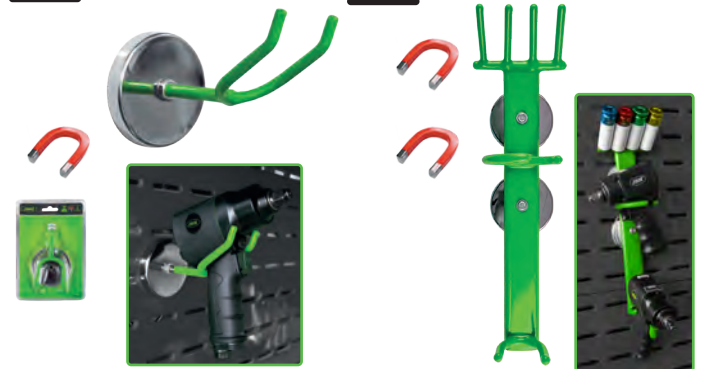

SET OF 2 MAGNETIZED SHELVES

50790 29,00€

1.17	-	12	96
Kg	sub	ff	ff

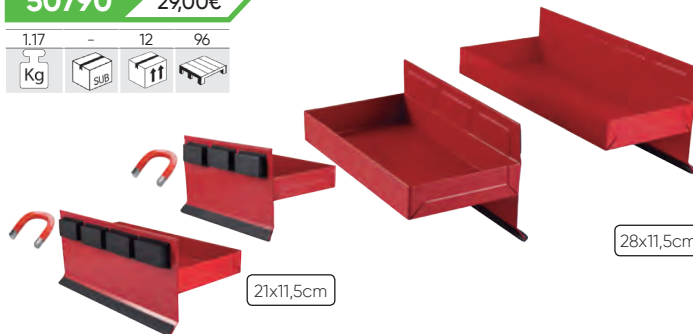

MAGNETIC BAR FOR TOOLS

50789 29,00€

0.89	10	20	500
Kg	sub	ff	ff

600mm



SET OF 5 MAGNETS

53958 6,50€

0.05	10	100	-
Kg	sub	ff	ff

Ø 15mm



GAS REPLACEMENT

51986	11,90€		
0.18	-	24	1584
Kg	SUB	ff	ff
200ml			



GAS TORCH

51920	18,00€		
0.14	10	100	400
Kg	SUB	ff	ff

- Gas not included.



LOOSENING TOOL FOR HENN-TYPE HOSE CLAMPS

53696	22,00€		
0.10	6	96	1536
Kg	SUB	ff	ff

- Volkswagen, Audi, Seat, Škoda, BMW, Peugeot, Citroën, Dacia, Fiat, Ford, Kia, Lexus, Mazda, Mercedes, Nissan, Opel/Vauxhall, Porsche, Renault, Toyota, Volvo.

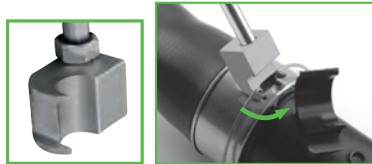

BREAK AND RIVETING TOOL FOR MOTORBIKE CHAINS

53055	33,00€		
0.89	5	10	480
Kg	SUB	ff	ff



MOTORCYCLE CHAIN CUTTER

53665	19,00€		
0.35	10	60	1920
Kg	SUB	ff	ff

25-60



53666	28,00€		
0.70	5	30	1920
Kg	SUB	ff	ff

60-100



BATTERY CARRYING HANDLE

52319	8,80€		
0.18	12	48	720
Kg	SUB	ff	ff



52621	11,00€		
0.14	10	40	960
Kg	SUB	ff	ff



x2



38 PCS WIRE BRUSH SET

51989 49,00€

1,64	-	10	120
Kg	SUB	ff	ff



Ø 8, 9, 10, 11, 12, 13, 14,
15, 16, 17, 18, 19mm

38
PCS

- 1 1/4" handle.
- 1 extender.
- 36 brushes.



WIRE SCRATCH BRUSH

52760 4,10€

0,09	6	120	2160
Kg	SUB	ff	ff



3 PIECE BRAKE CALIPER BRUSH SET

52515 9,10€

0,14	6	72	800
Kg	SUB	ff	ff

- 1 x Brass.
- 1 x Nylon.
- 1 x Steel.



225mm

3
PCS



FUEL TANK SENDER WRENCH

53096 28,80€

1,00	5	10	300
Kg	SUB	ff	ff

89-170mm

15mm



FUEL TANK SENDER WRENCH 3 LEG

52757 16,00€

0,55	5	20	480
Kg	SUB	ff	ff



160mm
75mm



MOTORCYCLE SPECIAL SOCKET

53054 6,00€

0,16	12	72	1500
Kg	SUB	ff	ff

19, 22, 24mm



MOTORCYCLE SPECIAL SOCKET

53086 9,00€

0,18	12	72	1500
Kg	SUB	ff	ff

17, 19, 22, 24mm

3/8"



Yamaha, Kawasaki,
BMW, Suzuki, Honda





TIMING TOOLS

- 218 BMW
- 220 MERCEDES
- 222 VAG
- 227 RENAULT / NISSAN
- 228 FORD / MAZDA
- 230 JAGUAR / LAND ROVER
- 231 OPEL / VAUXHALL
- 234 CITROËN / PEUGEOT
- 235 VARIOUS
- 238 CABINET WITH TIMING TOOLS SET
/ EVA MODULES
- 241 SPECIAL TOOLS

PETROL ENGINE SETTING / LOCKING KIT BMW N42 / N46 1.8.2.0 CHAIN DRIVE

53259 97,00€

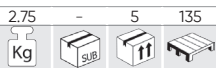

GASOLINA/PETROL

APPLICATIONS

BMW 1 SERIES: 118i E81/82/87/88 (04-14), 120i E81/82/87/88 (04-14).
BMW 3 SERIES: 316i/ti Compact E46 (01-07), 318i/ti Compact E46 (01-07), 318i, E90/91/92/93 (05-12), 320i E90/91/92/93 (05-12).
BMW 5 SERIES: 520i E60/61 (07-10), Z4 2.0 E85/86 (04-09).
BMW X SERIES: X1 sDrive 18i E84 (10-12), X1 xDrive 18i E84 (10-12), X3 2.0 E83 (05-10).

OEM TOOLS

119350 (1), 119340 (2), 119291 (3), 119292 (4), 119270 (5), 115120 (6), 119190 (7), 119293 (8)

ENGINE CODES

1.8: N42; B18A, N46; B18. / 2.0: N42; B20A, N46; B20, B20B, N46T; B20, B20B, B20BD, B20BZ, B20O2, B2O2.



CHAIN DRIVEN ENGINE LOCKING KIT BMW N43 ENGINE PETROL 1.6 / 2.0

53260 168,00€



GASOLINA/PETROL

APPLICATIONS

BMW | BMW 1 SERIES: 116i E81/82/87/88 (07-12), 118i E81/82/87/88 (06-14), 120i E81/82/87/88 (06-14).
BMW 3 SERIES: 316i/ti Compact E46 (01-07), 318i/ti Compact E46 (01-07), 320i E90/91/92/93 (07-13), 320i E90/91/92/93 (07-14).
BMW 5 SERIES: 520i E60/61 (07-10).

OEM TOOLS

118690 (118691/118692/118693) (1), 118710 (118711/118712) (2), 113340 (3) (4), 118700 (5), 119340 (119341/119342) (6), 115120 (7).

ENGINE CODES

1.6: N43 B16A/AA, B16AA, B16AA/OO.
2.0: N43 B20A, B20A/AA, B20AA, B20AY, B20KO, B20UO.

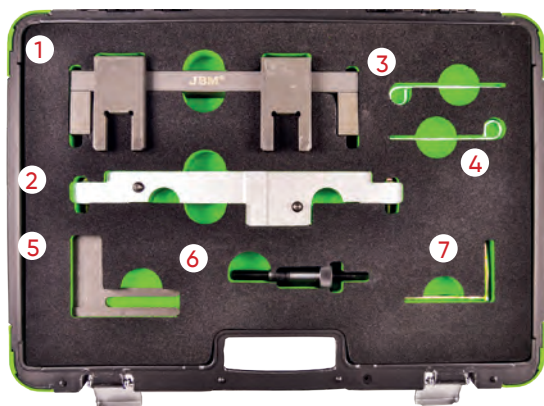

PETROL ENGINE TIMMING LOCKING KIT BMW N42 / N46

53261 214,00€



GASOLINA/PETROL

APPLICATIONS

BMW 1 SERIES: 118i E81/82/87/88 (04-14), 120i E81/82/87/88 (04-14).
BMW 3 SERIES: 316i/ti Compact E46 (01-07), 318i/ti Compact E46 (01-07), 318i E90/91/92/93 (05-12), 320i (E90/91/92/93 (05-14)).
BMW 5 SERIES: 520i E60/61 (07-10).
BMW X SERIES: X1 E84 sDrive 18i (10-12), X1 E84 xDrive 18i (10-12), X3 E83 2.0 (05-10).
BMW Z SERIES: Z4 2.0 E85/86 (04-09).

OEM TOOLS

119190 (1), 119310 (2), 119302 (3)

ENGINE CODES

2.0: N42 B18A, N42 B20A, N46 B18, N46 B20, N46 B20B, N46T B20, N46T B20B, N46T B20BD, N46T B20BZ, N46T B20O2, N46T B2O2

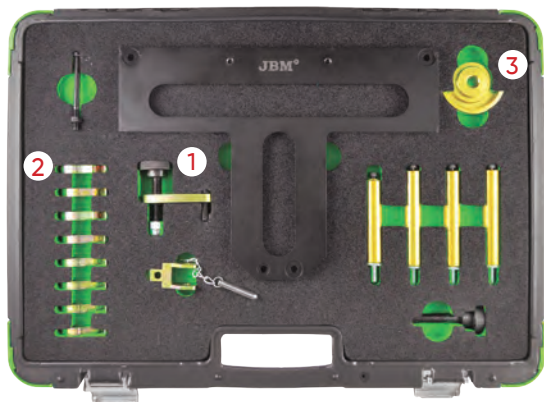

BMW M52TU / M54 / M56 DOUBLE VANOS CAMSHAFT ALIGNMENT TOOL

53262 251,00€



GASOLINA/PETROL

APPLICATIONS

M52TUB25: 1997-2001 E46 323i/323Ci/323ti (M52T); 1998-2001 E39 523i (M52TU); 1998-2001 E36/7 Z3 (M52TU).
M52TUB28: 1997-2001 E46 328i/328Ci (M52TU); 1997-2001 E36/7 Z3 2.8 (M52B28/Z3); 1998-2001 E39 528i (M52TU); 1998-2001 E38 728i (M52TU).
M54B22: 2001-2003 E46 320i/320Ci; 2001-2003 E39 520i; 2001-2002 E36 Z3 2.2i; 2003-2005 E85 Z4 2.2i; 2003-2005 E60/E61 520i.
M54B25: 2001-2002 E36/7 Z3 2.5i; 2001-2005 E46 325i/325xi; 2001-2006 E46 325Ci; 2001-2004 E46 325ti; 2001-2004 E39 525i; 2003-2004 E60/E61 525i/525xi; 2004-2006 E83 X3 2.5i; 2004-2006 E85 Z4 2.5i.
M54B30: 2001-2005 E46 330i/330xi; 2001-2006 E46 330Ci; 2001-2003 E39 530i/2001-2002 E36 Z3 3.0i; 2003-2005 BMW E60 530i; 2003-2006 E85 Z4 3.0i; 2001-2006 E53 X5 3.0i.

OEM TOOLS

116150 (1), 113450 (2), 113292 (3), 116180 (4), 114220(5)

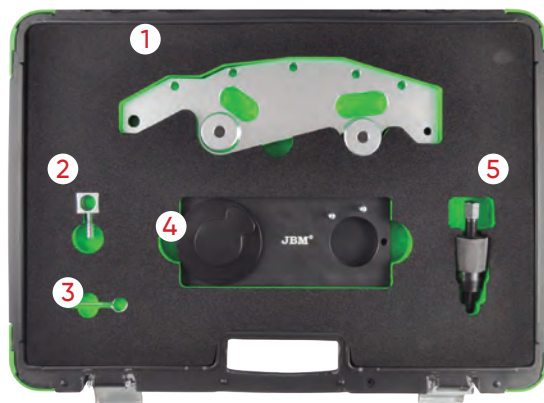

CAMSHAFT ALIGNMENT TOOL BMW M47

53263 57,00€

1.80 - 5 165

Kg SUB

DIESEL/GASOIL



APPLICATIONS	BMW BMW 1 SERIES: 118d E87 (04-07), 120d E87 (04-07). BMW 3 SERIES: 318d/td Compact E46 (01-05), 318d/td E90/91 (05-08), 320d/td Compact E46 (98-05), 320d/cd E90/91 (05-08), 325d E90/91/92/93 (02-10), 330d/cd E46/90/91/92/93 (99-07), 335d E90/91/92 (06-11). BMW 5 SERIES: 520d E39/60/61 (00-09), 525d/xd E39/60/61 (00-10), 530d/xd E46/60/61 (98-10), 535d E60/61 (04-10). BMW 6 SERIES: 635d E63/64 (07-11). BMW 7 SERIES: 730d/ld E38/65/66 (98-08). BMW X SERIES: X3 2.0d E83 (04-07), X3 3.0d/sd E83 (03-10), X5 3.0d E53/E70 (00-10), X6 3.0d E71/72 (08-10), X6 3.5d E71/72 (08-10). LAND ROVER: Freelander Td4 (00-06), Range Rover Td6 (02-06). MG/ROVER: MG-ZT/T (01-05), Rover 75 CDT/CDTi (99-05). VAUXHALL/OPEL: Omega-B (01-03).
OEM TOOLS	112300/12-108, 12-171/KM-813 (1), 113340/12-172/KM-823 (2) (3), 116322/12-174/KM-6267 (4) 116320 (5)
ENGINE CODES	BMW 2.0D: M47, M47T2, M47TU / 2.5D: M57, M57T2, M57TU / 3.0D: M57, M57T2, M57TU LAND ROVER 2.0D: 204D3 (TD4) / 3.0D: 306D1 (TD6) MG/ROVER 2.0D: M47R / 2.0d CDT: M47R VAUXHALL/OPEL 2.5D: Y25DT

ENGINE TIMING TOOL SET FOR BMW, MINI 1.2, 1.5, 2.0, 3.0

54228 187,00€

5.15 - 2 48

Kg SUB

GASOLINA/PETROL

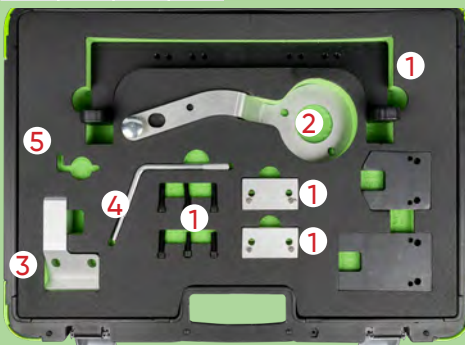

APPLICATIONS	BMW: 1 Series (2015 - 2019), 2 Series (desde 2014), 3 Series (desde 2015), 4 Series (desde 2015), 5 Series (desde 2017), 6 Series (desde 2017), 7 Series (desde 2015), 8 (desde 2014), X1 (desde 2015), X2 (desde 2018), X3 (desde 2017), X4 (desde 2018) and Z4 (desde 2019); MINI: Clubman (desde 2015), Hatch (desde 2014), Convertible (desde 2016) and Countryman (desde 2017)
OEM TOOLS	2 358 122 (1), 2 357 904 (2), 2 365 488 (3), 2 288 380 (4), 11 4 120 (5).
ENGINE CODES	BMW: 1,5 B38 A15A, B38 B15A, B38 K15A ,1,6 B48 B16A, 2,0 B48 A20A, B48 A20B, B48 A20E, B48 B20A, B48 B20B , 3,0 B58 B30A, B58 B30B, B58 B30C Mini 1,2 B38 A12A , 1,5 B36 A15A, B38 A15A , 2,0 B46 B20A, B48 A20A, B48 A20B

ENGINE TIMING TOOL FOR MINI 1.6

54222 59,00€

1.40 5 10 240

Kg SUB

GASOLINA/PETROL

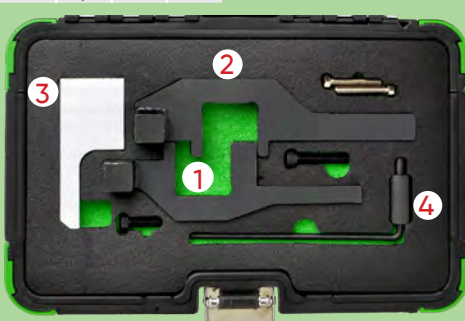

APPLICATIONS	BMW: Mini cooper S(07-10) Peugeot: 207(06-10), 307(06-10), THP(06-10), GTI(06-10) Citroen: DS3(06-10), C4(06-10), Grande Picasso TPH(06-10)
OEM TOOLS	119550(1), 119551(2), 119552(3), 119590(4)
ENGINE CODES	N14 B16A , N14 B16CD , N14 B16TO

DIESEL ENGINE TIMING TOOL KIT BMW

53265 195,00€

5.45 - 2 40

Kg SUB

DIESEL/GASOIL

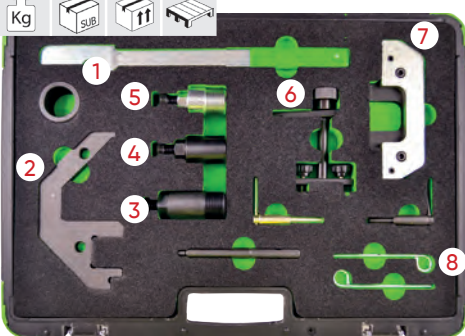

APPLICATIONS	BMW
OEM TOOLS	113360 (1), 116321 (2), 135190 (3), 135191 (4), 135192 (5), 116322 (6), 112300 (7), 113340 (8)
ENGINE CODES	M41 / M51 / M47TU / M47TU T2. M57TU T2 3.01 1998 - 2008.

VAT not included

TIMING TOOL SET FOR BMW M42 / 44 / 50 / 52 / 54 / 56

53267

277,00€

GASOLINA/PETROL

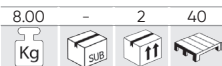

APPLICATIONS	BMW SERIES: 3, 5, 7, X, Z
OEM TOOLS	114220 (1), 112300 (2), 113240 (3), 115490 (4), 113292 (5), 113450 (6)
ENGINE CODES	M40, M44, M50, M52, M54, M56.

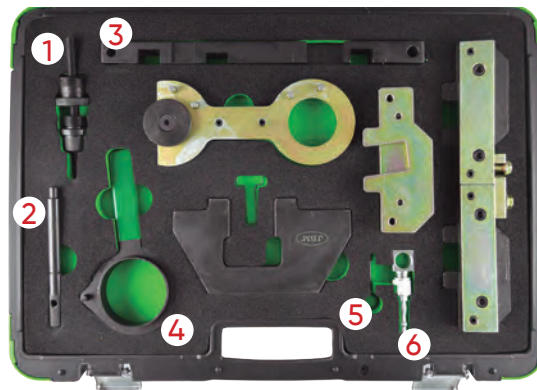

ENGINE CAMSHAFT ALIGNMENT TIMING LOCKING GARAGE TOOL FOR BMW N62 / N73

53264

143,00€

GASOLINA/PETROL

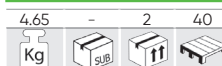

APPLICATIONS	<p>BMW 5 SERIES: 540i E60/61 (05-10), 545i E60/61 (03-06), 550i E60/61 (05-10).</p> <p>BMW 6 SERIES: 645i E63/64 (03-06), 650i E63/64 (05-11).</p> <p>BMW 7 SERIES: 735i E65/66 (02-05), 740i E65/66 (05-10), 745i E65/66 (02-05), 750i E65/66 (05-08), 760i E65/66 (02-08).</p> <p>BMW X SERIES: X5 4.4 E53 (03-07), X5 4.8 E53/E70 (04-10).</p>
OEM TOOLS	119463 (1), 119462 (2), 119340 (3), 119461 (4), 119190 (5)
ENGINE CODES	<p>3.6 V8: N62 B36A</p> <p>4.0 V8: N62 B40A</p> <p>4.4 V8: N62 B44A</p> <p>4.8 V8: N62 B48B</p> <p>6.0 V12: N73 B60A</p>

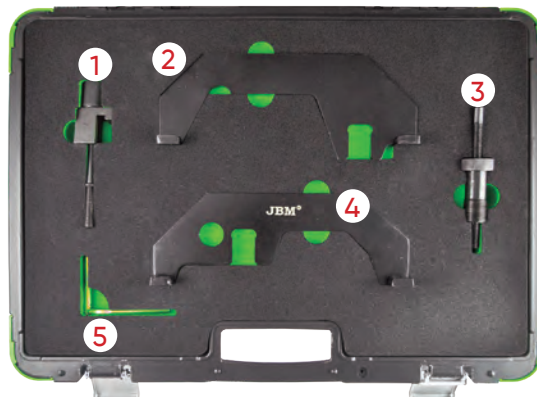

ENGINE TIMING TOOL SET BMW

53266

224,00€

DIESEL/GASOIL

GASOLINA/PETROL



APPLICATIONS	BMW
OEM TOOLS	113240 (1), 115490 (2), 113190 (3), 112300 (4) (5), 113292 (6), 113320 (7)
ENGINE CODES	<p>PETROL: M42, M43, M50, M52, M60.</p> <p>DIESEL: M51</p>

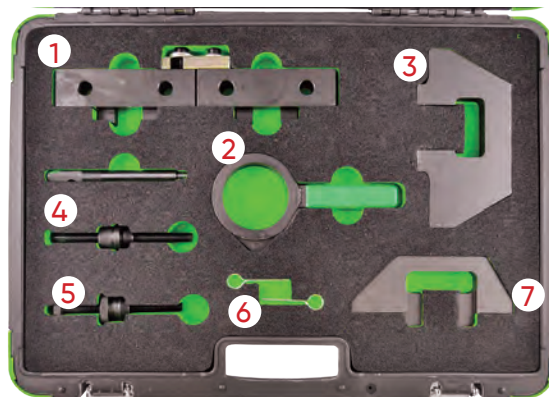

ENGINE TIMING LOCKING TOOLS SET FOR BMW

53269

50,00€

DIESEL/GASOIL

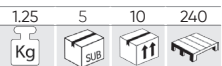

APPLICATIONS	<p>BMW 1 SERIES: 116d E81/82/87/88 (08-12), 118d E81/82/87/88 (07-14), 120d E81/82/87/88 (07-14), 123d E81/82/87/88 (07-14).</p> <p>BMW 2 SERIES: 218d (11-14), 220d (11-14), 225d (11-14).</p> <p>BMW 3 SERIES: 316d E90/91/92/93 (09-12), 318d E90/91/92/93 (07-12), 320d E90/91/92/93 (07-12), 325d E90/91/92/93 (10-14), 330d/xd E90/91/92/93 (08-14).</p> <p>BMW 5 SERIES: 520d E60/61 (07-10), 525d F10/11 (10-12), 530d F10/11 (10-13), 530dGT F07 (09-12), 535d F10/11 (10-17), 535dGT F07 (10-12).</p> <p>BMW 7 SERIES: 730d/Ld F01/02/04 (08-12), 740d F01/02/04 (09-12), 740d xDrive F01/02/04 (09-12), 750d xDrive F01/02/04 (12-15).</p> <p>BMW X SERIES: X1 sDrive 18d E84 (09-15), X1 sDrive 20d E84 (09-12), X1 xDrive 18d E84 (09-15), X1 xDrive 20d E84 (09-15), X1 xDrive 23d E84 (09-12), X3 2.0d E83 (07-10), X3 xDrive 18d E83 (08-10), X3 xDrive 30d E83 (11-12), X3 xDrive35d F25 (11-17), X5 3.0d E70 (10-13), X5 xDrive 40d X5 F15 M50d (13-17), E70 (10-13), X6 xDrive 30d E71/72 (10-14), X6 xDrive 40d E71/72 (10-14), X6 F16 M50d (14-17).</p> <p>BMW MINI: Paceman (13-17), Countryman (10-17), Mini (10-15), Roadster (12-14), Clubman (10-14), Clubvan (12-14).</p>
OEM TOOLS	118760 (1), 118740 (2), 116480 (3), 115320 (4)
ENGINE CODES	<p>1.6 D: N47, C16K1, C16U1.</p> <p>2.0 D: N47, C20K1, C20U1N47, D20, D20A, D20B, D20D, D20K1, D20O0, D20O1, D20T1, D20U0, D20U1, N47S D20T0, N47T, D20, D20O1, D20U1.</p> <p>3.0 D: N57, B30B, B30B/T0, B30C, D30BT0, D30O0, D30O1, D30T0, D30T1, D30U0.</p>

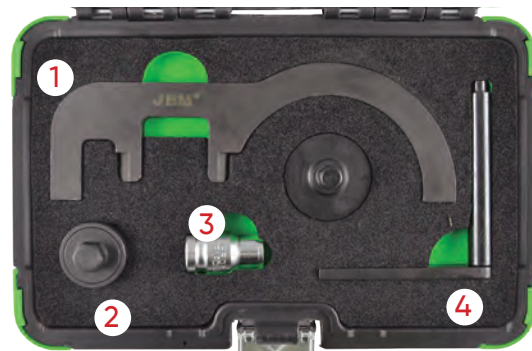

ENGINE TIMING TOOL SET FOR BMW & MINI 1.5/ 2.0L

54206 113,00€ **GASOIL/DIESEL**

1.75 - 5 135
Kg SUB ff

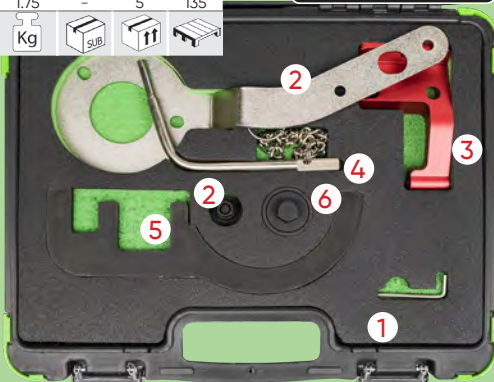

APPLICATIONS	BMW - 1 Series - 114d, 116d, 214d - (F20/ 21) - (2015- 2017) - 2 Series - 216d, 118d, 125d - (F22/ 23/ 45/ 46) - (2014-2017) - 3 Series - 218d, 220d, 225d - (F30/31/34) - (2015-2017) - 4 Series - 316d/ 320d/ 325d - (F32, 33, 36) - (2015-2017) - 5 Series - 420d, 425d, 418d - (F10, 11) - (2014-2017) - X1 Series - 518d - (F48) - (2015-2017) - X3 Series - (F25) - (2014-2017) - Efficient Dynamics - X4 Series - (F26) - (2014-2017) - xDrive - X5 Series - (F15) - (2015-2017) - sDrive Mini - Clubman - (F54) - (2015-2017) - One D Convertible - (F57) - (2016-2017) - Cooper D/ SD Mini Hatch (F55, 56) - (2014-2017)
OEM TOOLS	114120 (1), 2347904 (2), 2365488 (3), 2288380 (4), 118760 (5), 118740, 118030 (6)
ENGINE CODES	1.5: B37 D15A, B37 C15A 2.0: B47 D20A, B47 D20B, B47 C20A, B47, B47 C20B

ENGINE TIMING TOOL SET BMW MINI / PSA 1.4 & 1.6

53268 92,00€ **GASOLINA/PETROL**

2.60 - 5 120
Kg SUB ff

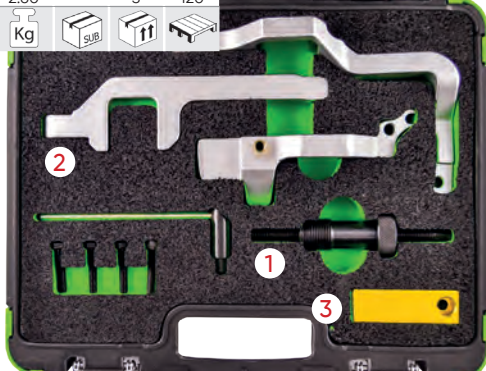

APPLICATIONS	BMW MINI: Mini Clubvan R55 (12-14), Mini Clubman R55 (08-14), Mini Countryman R55 (07-10), Mini Clubman R56/R57 (07-15), Mini R56/R57 (08-15), Mini Coupe R58 (11-15), Mini Roadster R59 (08-15), Mini Clubman R60 (10-14), Mini Clubvan R60 (12-14), Mini Roadster R61 (13-15), Mini Paceman R61 (14-15), Mini Countryman R60 (10-17). CITROËN: C4 (08-11), C4 Picasso (08-13) C4 Grand Picasso (13-15). PEUGEOT: 207 (06-14), 207CC (07-15), 308 (07-15), 3008 (09-15), 5008 (09-15).
OEM TOOLS	BMW MINI: 115590 (1), 119340 (2), 119551 (3) CITROËN: 0197-A1, 0197-A3, 0197-B. PEUGEOT: 0197-A1, 0197-A3, 0197-BZ.
ENGINE CODES	1.4: N12B14, N14B14AB. 1.6: EP3(8FS), EP3C(8FR), EP6(5FW), EP6C(5FS), EP6CDT(5FV), EP6DT(5FT), EP6DT(5FX), EP6DTS(5FY), N14B16A, N14B16CD, N14B16TO, N14B16CD/TO, N16B16A, N16B16KO, N16B16A/MO, N16B16A/MO, N16B16MO, N16B16UO.

ENGINE TIMING TOOL SET BMW MINI / PSA 1.4 & 1.6

54227 122,00€ **GASOLINA/PETROL**

2.40 - 5 135
Kg SUB ff



APPLICATIONS	BMW : Serie 1 (2011 - 2015), Serie 3 (2012 - 2015). MINI: Clubman (2011 - 2014), Mini (2010 - 2015), Coupe (2011 - 2015), Roadster (2012 - 2015), Countryman (2010 - 2017) and Paceman (2013 - 2017).
OEM TOOLS	117440 (1), 119340 (2), 2299362 (3)
ENGINE CODES	N12, N13, N14, N18, EP3, EP6

ALIGNMENT TOOL SET FOR BMW/MINI/ CITROËN/PEUGEOT

54219 60,00€ **GASOLINA/PETROL**

1.09 - 5 135
Kg SUB ff



APPLICATIONS	BMW, MINI, PSA
OEM TOOLS	115140(1), 119280(2), 119330(3), 113340 (4), 114360 (5)
ENGINE CODES	BMW 1.6 (N40 / N45 / N45T, B16, B16A, B16AC) 1.8 / 2.0 (N42 / N46 / N46T) 2.0 / 3.0 (N51 / N52 / N52-Componente / N53 / N54) PSA 1.4 / 1.6 16V (EP3 / EP6 / EP6DT / EP6DTS) MINI 1.4 / 1.6 (N12 / N14)

BMW FUEL INJECTOR REMOVAL AND INSTALLATION TOOL MERCEDES BENZ

54220 197,00€ **GASOLINA/PETROL**

4,40 Kg 2 SUB 2 240

APPLICATIONS	BMW: 135is (2008-),335 (2007-),335xi (2007-),535i (2008-),535xi (2008-),550i GT (2010-),750Li (2009-) 750i (2009-), X3 3.0i (2007-),X5 (2011-),X5 3.0i (2008-),X6 (2008-) MERCEDES-BENZ: C-class (2007-),CLK / SLK (2007-),E-class (2007-),A / CLA / GLA 45 AMG (2013-),CL / CLS 63 AMG (2010-),E / G / GL 63 AMG (2011-),GLE 63 AMG (2015-S / SL 63 AMG (2010-),SLK 55 AMG (2012-)
OEM TOOLS	BMW: 130180(1), 130195(2), 130270(3), 130320(4), 2249115(5) Mercedes-Benz: 271589023300(6), 278589003300(7)
ENGINE CODES	BMW : N14 / N18 / N20 / N47 / N54 / N57 / N55 / N63 Mercedes-Benz : M133 / M152 / M157 / M270 / M271 / M274 / M276 / M278

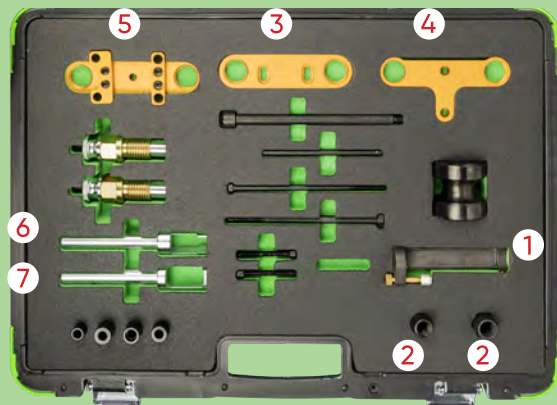

ALIGNMENT TOOL SET FOR MERCEDES BENZ M271

53271 227,00€ **GASOLINA/PETROL** **GASOIL/DIESEL**

4,55 Kg 2 SUB 40

APPLICATIONS	MERCEDES
OEM TOOLS	271 589 003100 (1), 271589014000 (2), 271589001500 (3), 156589006100 (4)
ENGINE CODES	M271, E18ML 2002, DE18ML 2003 - 2005, E16ML 2008, DE18LA 2009.

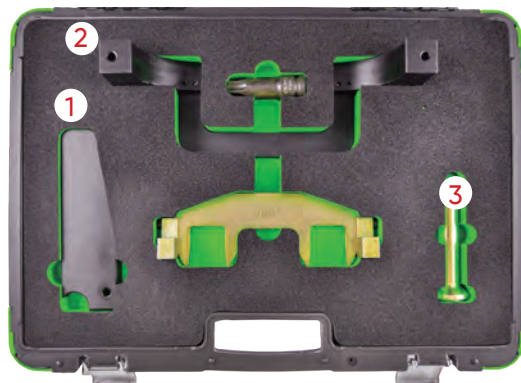

MERCEDES BENZ AMG 156 TIMING TOOL KIT

53272 195,00€ **GASOLINA/PETROL** **GASOIL/DIESEL**

2,10 Kg 5 SUB 160

APPLICATIONS	MERCEDES
OEM TOOLS	156589006100 (1), 156589003200 (2), 156589016300 (3), 156589006900 (4)
ENGINE CODES	BENZ AMG 156,ML 63 AM.G.S 63L AM.G.S 63. AM.G. R 63 AM.G L 4MATIC. R63 AM.G 4MATIC. E 63 AM.G. CLS 63 AM.G. CLK 63 AM.G. CLK 63 AM.G Black series. CLK 63 AM.G Cabrio. CL 63 AM.G.

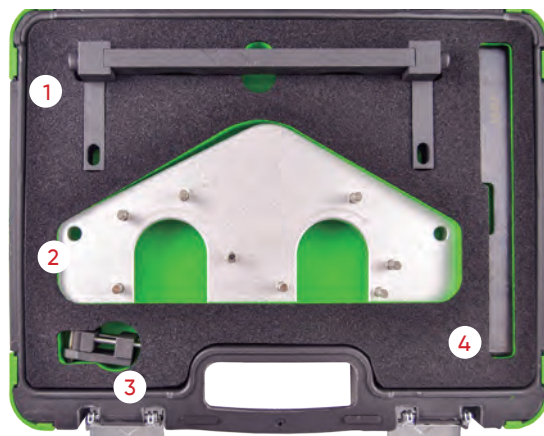

ENGINE TIMING TOOL KIT MERCEDES / CHRYSLER / JEEP

53270 70,00€ **GASOLINA/PETROL** **GASOIL/DIESEL**

1,40 Kg 10 SUB

APPLICATIONS	MERCEDES CHRYSLER JEEP
OEM TOOLS	112589034000 (1), 601589024000 (2), 111589031500 (3)
ENGINE CODES	Herr.: 112 589 03 40 00: 112, 113, 137, 155, 156, 272/979, 273, 629, 642/992. Herr.: 601 589 02 40 00: 102, 103, 104, 111, 601, 602.91/93/94/96/983, 603.91/93/96/97, 604, 605, 606, 611, 612/965/966, 613. Herr.: 111 589 03 15 00: 111, 119, 604, 605, 606, 611/980, 612, 613, 628, 629, 640, 642/922, 612.965/966, 646, 647, 648.

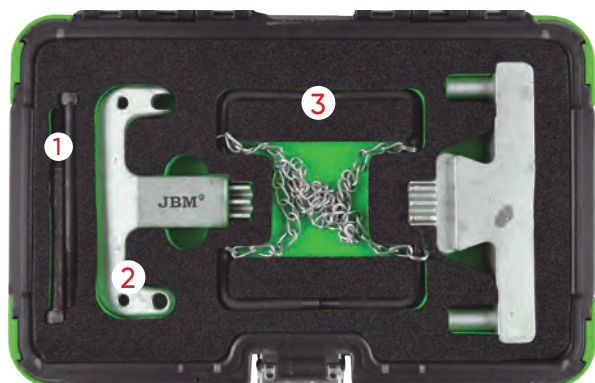

ENGINE TIMING TOOL FOR MERCEDES M276 / M157 / M278

53273 75,00€



GASOLINA/PETROL

GASOIL/DIESEL



APPLICATIONS	MERCEDES																				
OEM TOOLS	27658901400																				
ENGINE CODES	<table border="0"> <tr> <td>CL 500 / 63 AMG (C 216) 2010-2013.</td> <td>C 400 (W 205) 2014.</td> </tr> <tr> <td>S 500 / 63 AMG (C 217) 2014.</td> <td>E 400 HYBRID (W 212) 2012.</td> </tr> <tr> <td>CLS 300 (C 218) 2012.</td> <td>G 63 AMG (W 463) 2012.</td> </tr> <tr> <td>E 300 / 350 / 400 (C/A 207) 2011.</td> <td>E 300 / 350 / 400 / 500 / 63 AMG (W/S 212) 2011.</td> </tr> <tr> <td>CLS 350 / 400 / 500 / 63 AMG (C/X 218) 2011-2014.</td> <td>C 350 (W/S/C 204) 2011.</td> </tr> <tr> <td>SLK 350 (R 172) 2011.</td> <td>S 350 / 500 / 63 AMG (W/V 221) 2010.</td> </tr> <tr> <td>SL 350 / 400 / 500 / 63 AMG (R 231) 2012.</td> <td>S 400 / 63 AMG (W/V 222) 2013.</td> </tr> <tr> <td>S 500 PLUG-IN HYBRID (V 222) 2014.</td> <td>R 350 BlueEFFICIENCY (W/V 251) 2012.</td> </tr> <tr> <td>ML 300 / 350 / 500 / 63 AMG (W 166) 2011.</td> <td>GL 450 / 500 (X 166) 2012.</td> </tr> <tr> <td></td> <td>GLK 350 (X 204) 2011.</td> </tr> </table>	CL 500 / 63 AMG (C 216) 2010-2013.	C 400 (W 205) 2014.	S 500 / 63 AMG (C 217) 2014.	E 400 HYBRID (W 212) 2012.	CLS 300 (C 218) 2012.	G 63 AMG (W 463) 2012.	E 300 / 350 / 400 (C/A 207) 2011.	E 300 / 350 / 400 / 500 / 63 AMG (W/S 212) 2011.	CLS 350 / 400 / 500 / 63 AMG (C/X 218) 2011-2014.	C 350 (W/S/C 204) 2011.	SLK 350 (R 172) 2011.	S 350 / 500 / 63 AMG (W/V 221) 2010.	SL 350 / 400 / 500 / 63 AMG (R 231) 2012.	S 400 / 63 AMG (W/V 222) 2013.	S 500 PLUG-IN HYBRID (V 222) 2014.	R 350 BlueEFFICIENCY (W/V 251) 2012.	ML 300 / 350 / 500 / 63 AMG (W 166) 2011.	GL 450 / 500 (X 166) 2012.		GLK 350 (X 204) 2011.
CL 500 / 63 AMG (C 216) 2010-2013.	C 400 (W 205) 2014.																				
S 500 / 63 AMG (C 217) 2014.	E 400 HYBRID (W 212) 2012.																				
CLS 300 (C 218) 2012.	G 63 AMG (W 463) 2012.																				
E 300 / 350 / 400 (C/A 207) 2011.	E 300 / 350 / 400 / 500 / 63 AMG (W/S 212) 2011.																				
CLS 350 / 400 / 500 / 63 AMG (C/X 218) 2011-2014.	C 350 (W/S/C 204) 2011.																				
SLK 350 (R 172) 2011.	S 350 / 500 / 63 AMG (W/V 221) 2010.																				
SL 350 / 400 / 500 / 63 AMG (R 231) 2012.	S 400 / 63 AMG (W/V 222) 2013.																				
S 500 PLUG-IN HYBRID (V 222) 2014.	R 350 BlueEFFICIENCY (W/V 251) 2012.																				
ML 300 / 350 / 500 / 63 AMG (W 166) 2011.	GL 450 / 500 (X 166) 2012.																				
	GLK 350 (X 204) 2011.																				

ENGINE TIMING TOOL SET CHRYSLER JEEP LDV 2.5 CRD

54207 38,90€



GASOIL/DIESEL



APPLICATIONS	Chrysler: Voyager (01-08), Grand Voyager (01-08) Jeep: Cherokee (01-08) LDV: Maxus (05-09)		
OEM TOOLS	VM 9660 (1), VM1052 (2), VM1053 (3), VM1068 / VM1089 (4), VM1080 (5), VM8873 (6)		
ENGINE CODES	<table border="0"> <tr> <td>2.5D CRD: R2516C, R2516K, R2516LVM39/40B.</td> <td>2.8D CRD: R2816C5.05A, R2816K4.</td> </tr> </table>	2.5D CRD: R2516C, R2516K, R2516LVM39/40B.	2.8D CRD: R2816C5.05A, R2816K4.
2.5D CRD: R2516C, R2516K, R2516LVM39/40B.	2.8D CRD: R2816C5.05A, R2816K4.		

TURBO TIMING SET VAG 1.2 TFSI

54092 24,00€



GASOLINA/PETROL

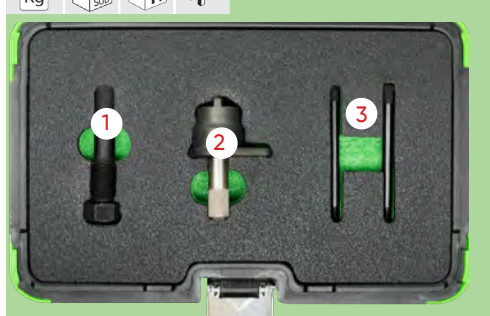

APPLICATIONS	<u>Audi:</u> A1, A3, A3 Sportback, A3 Cabrio <u>Seat:</u> Altea, Altea XL, Ibiza, Leon, Toledo <u>Skoda:</u> Fabia II, Oktavia II, Praktik, Rapid, Rapid Spaceback, Rommster, Yeti <u>VW:</u> Beetle, Caddy, Caddy Maxi, Golf Plus, Golf VI, Golf VI Cabrio, Golf VI Estata, Jetta, Polo, Touran
OEMTOOLS	T10340(1), T10414(2), T10341(3)
ENGINE CODES	CBZA, CBZB, CBZC

TIMING BELT DOUBLE PIN WRENCHES TOOLS SET VW / AUDI

53277 45,00€



GASOLINA/PETROL

GASOIL/DIESEL



APPLICATIONS	<table border="0"> <tr> <td>PETROL</td> <td><u>AUDI:</u> 80, 100, A3, A4, A6 1.6, 1.8/Turbo, 2.0, 2.0 16v, A3, A4 1.6 (96-). <u>SEAT:</u> Ibiza/Cordoba, Toledo, Alhambra, Inca 1.6, 1.8, 1.8 16v, 2.0, 2.0 16v/Ibiza/ Cordoba, Leon, Toledo 1.6 (99-), Alhambra 2.0 (00-). <u>VOLKSWAGEN:</u> Polo Classic, Scirocco, Corrado, Golf, Jetta, Vento, Passat, Sharan, Transporter 1.6, 1.8/Turbo, 1.8 16v, 2.0, 2.0 16v, Polo Classic, Golf, Bora, Beetle 1.6 (97-), 2.0 (99-). <u>SKODA:</u> Octavia 1.6 (97-), 2.0 (99-).</td> </tr> <tr> <td>DIESEL</td> <td><u>AUDI:</u> 80, 100, A3, A4, A6 1.9 Turbo D, 1.9TDi, 2.5TDi, A3, A4, A6 2.0TDi, A2, A3, A4, A6 1.2TDi, 1.4TDi, 1.9TDi (99-). <u>SEAT:</u> Ibiza/Cordoba, Leon, Toledo, Alhambra, Inca 1.7SDi, 1.9D/TD /Sdi/Tdi. <u>FORD:</u> Galaxy (02-06). <u>SKODA:</u> Felicia, Octavia 1.9D/Tdi. <u>VW:</u> Polo, Polo Classic, Golf, Jetta, Vento, Bora, Beetle, Passat, Sharan, Caddy, Transporter 1.5D, 1.6D/ Turbo, 1.7D/Sdi, 1.9Sdi/Tdi, Golf, Passat 2.0TDi.</td> </tr> </table>	PETROL	<u>AUDI:</u> 80, 100, A3, A4, A6 1.6, 1.8/Turbo, 2.0, 2.0 16v, A3, A4 1.6 (96-). <u>SEAT:</u> Ibiza/Cordoba, Toledo, Alhambra, Inca 1.6, 1.8, 1.8 16v, 2.0, 2.0 16v/Ibiza/ Cordoba, Leon, Toledo 1.6 (99-), Alhambra 2.0 (00-). <u>VOLKSWAGEN:</u> Polo Classic, Scirocco, Corrado, Golf, Jetta, Vento, Passat, Sharan, Transporter 1.6, 1.8/Turbo, 1.8 16v, 2.0, 2.0 16v, Polo Classic, Golf, Bora, Beetle 1.6 (97-), 2.0 (99-). <u>SKODA:</u> Octavia 1.6 (97-), 2.0 (99-).	DIESEL	<u>AUDI:</u> 80, 100, A3, A4, A6 1.9 Turbo D, 1.9TDi, 2.5TDi, A3, A4, A6 2.0TDi, A2, A3, A4, A6 1.2TDi, 1.4TDi, 1.9TDi (99-). <u>SEAT:</u> Ibiza/Cordoba, Leon, Toledo, Alhambra, Inca 1.7SDi, 1.9D/TD /Sdi/Tdi. <u>FORD:</u> Galaxy (02-06). <u>SKODA:</u> Felicia, Octavia 1.9D/Tdi. <u>VW:</u> Polo, Polo Classic, Golf, Jetta, Vento, Bora, Beetle, Passat, Sharan, Caddy, Transporter 1.5D, 1.6D/ Turbo, 1.7D/Sdi, 1.9Sdi/Tdi, Golf, Passat 2.0TDi.
PETROL	<u>AUDI:</u> 80, 100, A3, A4, A6 1.6, 1.8/Turbo, 2.0, 2.0 16v, A3, A4 1.6 (96-). <u>SEAT:</u> Ibiza/Cordoba, Toledo, Alhambra, Inca 1.6, 1.8, 1.8 16v, 2.0, 2.0 16v/Ibiza/ Cordoba, Leon, Toledo 1.6 (99-), Alhambra 2.0 (00-). <u>VOLKSWAGEN:</u> Polo Classic, Scirocco, Corrado, Golf, Jetta, Vento, Passat, Sharan, Transporter 1.6, 1.8/Turbo, 1.8 16v, 2.0, 2.0 16v, Polo Classic, Golf, Bora, Beetle 1.6 (97-), 2.0 (99-). <u>SKODA:</u> Octavia 1.6 (97-), 2.0 (99-).				
DIESEL	<u>AUDI:</u> 80, 100, A3, A4, A6 1.9 Turbo D, 1.9TDi, 2.5TDi, A3, A4, A6 2.0TDi, A2, A3, A4, A6 1.2TDi, 1.4TDi, 1.9TDi (99-). <u>SEAT:</u> Ibiza/Cordoba, Leon, Toledo, Alhambra, Inca 1.7SDi, 1.9D/TD /Sdi/Tdi. <u>FORD:</u> Galaxy (02-06). <u>SKODA:</u> Felicia, Octavia 1.9D/Tdi. <u>VW:</u> Polo, Polo Classic, Golf, Jetta, Vento, Bora, Beetle, Passat, Sharan, Caddy, Transporter 1.5D, 1.6D/ Turbo, 1.7D/Sdi, 1.9Sdi/Tdi, Golf, Passat 2.0TDi.				
OEM TOOLS	T10020 (1), 3387 (2), V159 (3), T10060/T100604 (4), T10115 (5), T40011 (6)				
ENGINE CODES	2.0, 2.8, 3.0				

TIMING BELT SETTING KIT FOR VAG 1.2/1.4 TSI

53648 107,00€

GASOLINA/PETROL

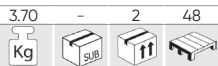

APPLICATIONS

AUDI: A1 (12-15), A1 Sportback (12-15), A3 (13-15), A3 Sportback (12-15).
SEAT: Ibiza (12-15), Leon (12-15), Toledo (12-15).
SKODA: Fabia (10-13), Octavia II (10-13), Octavia III (10-15).

OEM TOOLS

T10060A (1), T10340 (2), T10476 (3), T10494 (4), T10499 (5), T10504/1 (6), T10504 (7), T10504/2 (8).

ENGINE CODES

1.2 TSi: CJZA, CJZB.
 1.4 TSi: CGGA, CHPA, CMBA, CPVA, CRJA, CXSA.
 1.4 TSi ACT: CPTA.

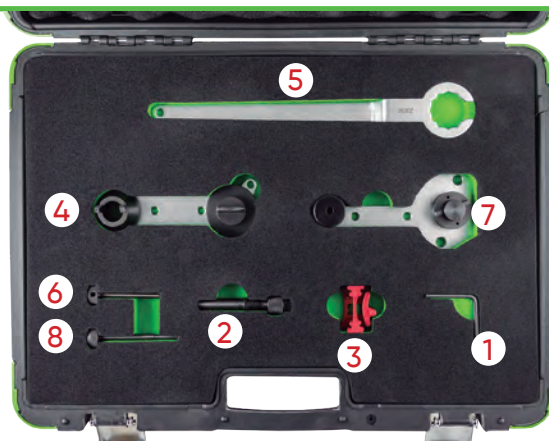

CAMSHAFT ALIGNMENT TOOL KIT VAG 1.4/1.6/2.0 TDI COMMON RAIL

53706 98,00€

GASOIL/DIESEL

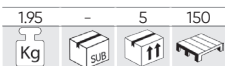

APPLICATIONS

VOLKSWAGEN: Golf Alltrack, Golf Sportsvan, Golf VII, Golf VII Kombi, Passat, Polo.
AUDI: A1, A1 Sportback, A3, A3 Cabriolet, A3 Limousine, A3 Sportback, TT, TT Roadster.
SEAT: Ibiza, Ibiza V Sportcoupe, Ibiza V ST, Leon, Leon SC, Leon ST, Toledo IV.
SKODA: Fabia, Fabia Kombi, Octavia, Octavia Combi, Rapid, Rapid Spaceback.

OEM TOOLS

OEM 3204 (1), OEM 3359 (2), OEM T10490 (3), OEM T10051 (4), OEM T10060A (5), OEM T10264 (6), OEM T10265 (7), OEM T10492 (8), OEM T40098 (9).

ENGINE CODES

1.4, 1.6, 2.0 TDI CR
 CXXB, DBKA, DCXA, CGLE, CKFB, CKFC, CLHA, CLHB, CNHA, CNHC, CRBD, CRFA, CRFC, CRKA, CRKB, CRLB, CRLC, CRMB, CRUA, CRVA, CRVC, CSUA, CSUB, CUNA, CUPA, CUSA, CUSB, CUTA, CUUD, CXEB, DBKA, DCXA, DCZA, DFSD.

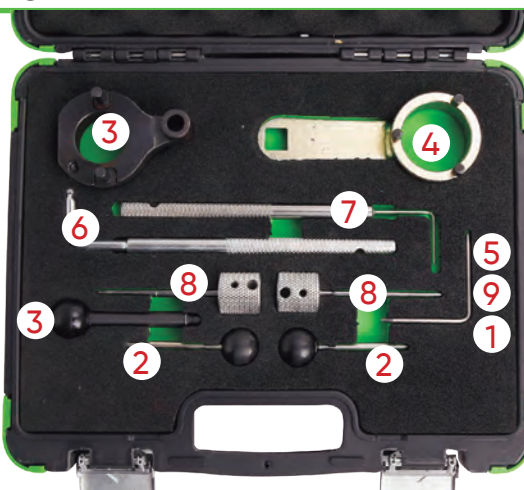

ENGINE TIMING TOOL VAG 2.5 / 4.9D / TDI

53284 306,00€

GASOIL/DIESEL



APPLICATIONS

VOLKSWAGEN: Touareg (03-10), Transporter (03-09).

OEM TOOLS

T10225 (1), T10199 (2), T10234 (3), T10226 (4), T10193 (5), T10194 (6), T10199/01 (7), T10226 (8).

ENGINE CODES

2.5D TDi PD: AXD, AXE, BAC, BLJ, BLK, BNZ, BPC, BPD, BPE.

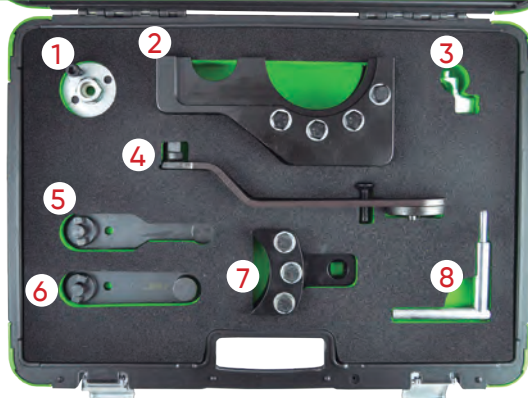

AUDI / VW ENGINE TIMING TOOL SET V6 2.0 / 2.8 / 3.0 TFSI

53278 143,00€

GASOLINA/PETROL

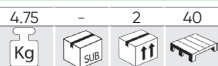

APPLICATIONS

A2, A4, A4 Quattro, A6 (2004-2007)
 A2, A3, A4, A3 FSI (2004-2007)
 A4, A6, A8 3.2 FSI
 A6 L Quattro 2.4
 A6 2.4, A6 2.4 Quattro (2004-2007)
 A4 3.2 FSI (2004-2007)
 A6 3.2 FSI (2004-2007)
 A8 3.2 FSI (2005-2007)

OEM TOOLS

T10172 (1), 3212 (2), T40070 (3), T40069 (4), T40071 (5), T10172/2 (6)

ENGINE CODES

AUK / BDW / BDY / BKH / CAJA / CALA

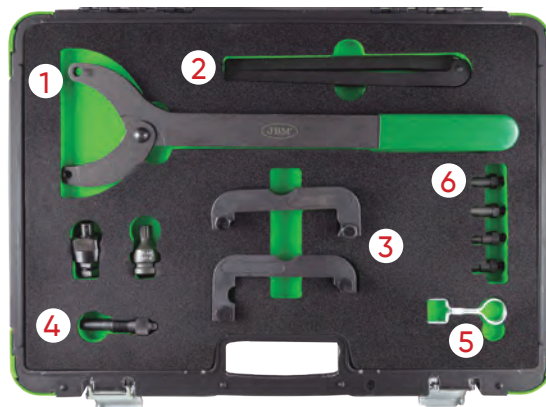

ENGINE TIMING TOOL AUDI / SKODA

53276

160,00€



GASOLINA/PETROL

GASOIL/DIESEL



APPLICATIONS

AUDI/VW ENGINES: V6 2.0, 2.8, 3.0T FSI.
AUDI Q5: 2.0, A6L 2.8, 3.0T.

OEM TOOLS

3418 (1), 3458 (2), T10100 (3), T10123 (4), T10121 (5), 3242 (6), 3551 (8), T10020 (9), T10098 (10), 3078 (12), 2064 (13), 3369 (14), T10092 (15), T40011 (17), 2065A (18), T10016 (19), 3359 (20), T10008(21), T10050 (22) T10265 (23), T10264 (24), T10060A (25), T10120 (27), 3366 (28)

ENGINE CODES

2.0, 2.8, 3.0

CAMSHAFT ALIGNMENT TOOL VW / AUDI

53281

55,00€

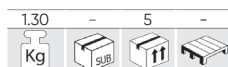

GASOIL/DIESEL



APPLICATIONS

VOLKSWAGEN: 2.5 TDI V6 DIESEL
AUDI: A4, A6, A8

OEM TOOLS

3369 (1), 3242 (2), 3458 (3)

ENGINE CODES

AFB/AKN

TIMING BELT DOUBLE PIN WRENCHES TOOLS SET VW / AUDI

53282

48,00€

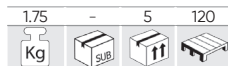

GASOLINA/PETROL



APPLICATIONS

SEAT: Alhambra (10-15), Altea/Altea XL (08-15), Ibiza/ Cordoba (08-12), Leon (07-13), Toledo (07-15).
VOLKSWAGEN: Beetle (11-15), Caddy/Caddy Maxi (10-15), EOS (06-12), Golf (03-12), Golf Plus (03-14), Golf V Estate (07-13), Golf VI Cabriolet (10-15), Jetta (06-14), Passat (05-11), Polo (02-14), Scirocco (08-12), Tiguan (07-12), Touran (03-15).
SKODA: Fabia II (07-15), Octavia II (04-15), Praktik (10-15), Rapid (12-15), Roomster (06-15), Superb II (09-14), Yeti (09-14).
AUDI: A1 (10-15), A3 (03-13).

OEM TOOLS

T10171 (1), T10170 (2), T40011 (3)

ENGINE CODES

1.2 TFSI: CBZA, CBZB, CBZC.
1.4 FSI: AXU, BKG, BLN.
1.4 TFSI: BLG, BMY, BWK, CAVA, CAVB, CAVC, CAVD, CAVE, CAVF, CAXA, CAXC, CDGA, CSMA.
1.6 FSI: BAG, BLF, BLP, BTS.

VOLKSWAGEN / SEAT / SKODA 1.2L ENGINE TIMING TOOL KIT

53274

30,50€



GASOLINA/PETROL

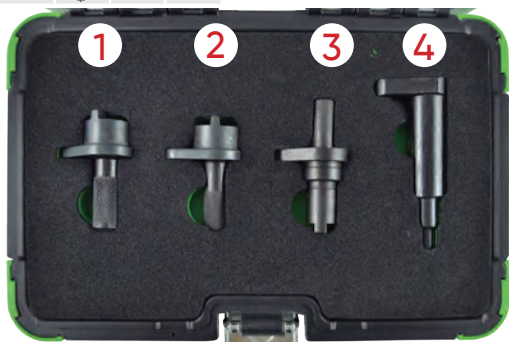

APPLICATIONS

VOLKSWAGEN
1.2: Lupo / Polo / Eos / Fox.
SEAT
1.2: Ibiza / Cordoba
SKODA
1.2: Fabia

OEM TOOLS

T10123 (1) (2), T10120 (3), T10121 (4)

ENGINE CODES

AWY / BMD / AZQ / BME.

VW / AUDI 2.0L FSI TFSI SOHC TURBO ENGINE TIMING TOOL SET

53279 97,00€



GASOLINA/PETROL

APPLICATIONS	AUDI: A3 (96-09), A4 (94-09), A6 (95-11), S3 (99-13), TT (98-14). SEAT: Alhambra (97-10), Altea/Altea XL (06-09), Cordoba (99-02), Exeo (09-10), Ibiza (99-02), Leon (99-13), Toledo (99-09). SKODA: Octavia/Octavia Tour (98-10), Octavia II (04-09). VOLKSWAGEN: Beetle (99-11), Bora (97-04), Eos (06-10), Golf (97-12), Golf Plus (05-09), Jetta (05-09), Passat (96-10), Scirocco (09-14), Sharan (97-10), Touran (03-09).
OEM TOOLS	T10020 (1), T10252 (2), T10092 (3), T10115 (4), T40011 (4), 3366 (5), T10060 (6)
ENGINE CODES	1.8: ADR, AFY, AGN, AJP, APG, APT, AQE, ARG, ARH, AVV. 1.8T: AEB, AGU, AJH, AJL, AJQ, AMK, AMU, ANB, APP, APU, APX, APY, AQA, AQX, ARX, ARY, ARZ, AUM, AUG, AVC, AWC, AWT, AWU, AYP, BAM, BFV, BVP, BVR. 2.0 FSI: AXW, BHD, BLR, BLX, BLY, BMB, BVX, BVY, BVZ. 2.0 TFSI/S/R/Tsi: AXX, BPY, BWA, BGB, BPG, BPJ, BUL, BWE, BWT, BYK, BHZ, BZC, BWJ, BYD, CDLA, CDLB, CDLC, CDLD, CDLF, CDMA.



ENGINE TIMING TOOL KIT FOR VAG TFSI, FSI

54199 94,00€



GASOLINA/PETROL

APPLICATIONS	Audi: A1 (10-15), A1 Sportback (10-15), A3 Cabriolet (10-13), A3 (10-15), A3 Sportback (03-13). Seat: Altea/Altea XL (10-15), Ibiza (10-15), Leon (10-13), Toledo (12-15). Skoda: Fabia II (10-15), Praktik (10-15), Rapid (12-15), Rapid Sportback (12-15), Octavia II (04-13), Yeti (09-15), Yeti Outdoor (13-15). VW: Beetle (11-15), Caddy/Caddy Maxi (10-15), EOS (07-15), Golf V (03-13), Golf V Estate (07-09), Golf VI (10-13), Golf VI Estate (10-13), Golf VI Cabriolet (11-15), Golf Plus (05-14), Jetta (05-14), Passat (05-15), Polo (09-14), Scirocco (08-14), Tiguan (07-15), Touran (03-15).
OEM TOOLS	T10414(1), VAS 6079(2), T10170(3), T10171/ T10171A(4), T40011(5), T10340(6), T10341 (7)
ENGINE CODES	1.2 TFSI: CBZA, CBZB, CBZC 1.4 FSI/TFSI: BLG, BMY, BWK, CAVA, CAVB, CAVC, CAVD, CAVE, CAVF, CAXA, CAXC, CDGA, CSMA 1.6 FSI: BAG, BLF, BLP

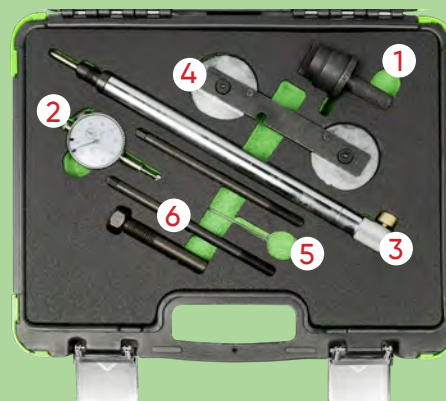

CAMSHAFT ALIGNMENT SET VW / AUDI

53280 112,00€

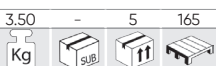

GASOLINA/PETROL

APPLICATIONS	AUDI: A4 (01-08), A6 (01-08), A8 (03-10).
OEM TOOLS	3387 (1), T40030 (2) (4), T40026 (3), T40028 (5)
ENGINE CODES	3.0 V6 3.0V: ASN, AVK, BBJ, BGN.



ENGINE TIMING TOOLS VW / AUDI

53326 16,00€



GASOIL/DIESEL



APPLICATIONS	VW: V6 2.5TDi. AUDI: V6 2.5TDi, V8 3.3TDi.
OEM TOOLS	3458 (1), 3242 (2)

ENGINE TIMING TOOLS VW 1.2L

53327 11,00€



GASOLINA/PETROL



APPLICATIONS	SEAT: Ibiza 1.2 6v/3cyl (2002-09), Cordoba 1.2 12v/3cyl (2002-13). VW: Polo 1.2 6v-12v/3cyl (2002-14). SKODA: Fabia 1.2 6v-12v/3cyl (2002, 2003-), Fabia II 1.2 6v/3cyl (2007-13), Roomster 1.2 12v/3cyl (2006-13), Praktik 1.2 6v/3cyl (2007-13).
OEM TOOLS	T10123.
ENGINE CODES	1.2 6v: AWY, BMD, BBM, CHFA, CHFB 1.2 12v: AZQ, BME, BVX, BZG, CEVA, CGPA, CGPB, CGPC.

ENGINE TIMING TOOL SET FOR VAG 2.7 / 3.0 TDI

53283 92,00€

GASOIL/DIESEL

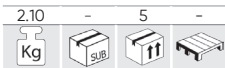

APPLICATIONS	VOLKSWAGEN: Touareg, Phateon VAG: Diesel 2.7 / 3.0 V6 AUDI: A4, A5, A6
OEM TOOLS	3242 (1), T40060 (2) (3), 3359 (4), T40058 (5), T40061 (6), T40062 (7), T40049 (8)
ENGINE CODES	ASB, BKN, BKS, BWZ, BNG, BPP, BSG, BUG, BUN, CAWA, CABB, CANA, CANB, CANC, CAND, CAPA, CARA, CARB, CASA, CASE, CASC, CAM, CC/ HA, CCWA, CCWB, CDYA, CDVB, CDVC, CEXA, CGKA, CGKB.

DIESEL ENGINE SETTING / LOCKING KIT VAG 2.4 / 2.5D SDI

53285 56,00€

GASOLINA/PETROL



APPLICATIONS	VOLKSWAGEN: Crafter (06-13), LT (96-06), Transporter (90-03).
OEM TOOLS	2065A (1), T50009 (2), T10025 (3), 3248/3419 (4), 2064 (5), 3355 (6)
ENGINE CODES	2.4D: AAB, AJA. 2.5D SDI: AGX. 2.5D Tdi: ACV, AHD, AHY, AJT, ANJ, APA, AUF, AVR, AXG, AXL, AYC, AYY, BBE, BBF. 2.5D TDiCR: BJJ, BJK, BJL, BJM.

ENGINE TIMING TOOL KIT VAG 1.8 / 2.0TSI

53286 87,00€

GASOLINA/PETROL

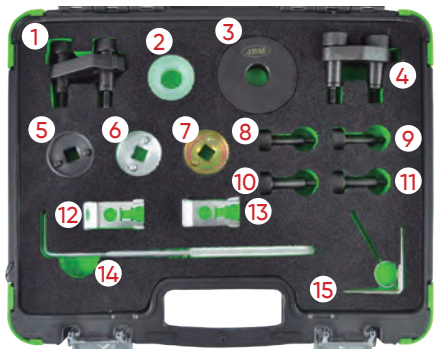
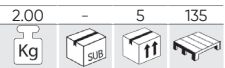

APPLICATIONS	VOLKSWAGEN: 1.8 / 2.0 TSI / TFSI.
OEM TOOLS	T10368 (2), T10354 (3), T40271 (1)(4), T10352/2 (5), T10352/1 (6), T10352 (7), T40196 (8) (9) (10) (11), T40267(12) (13), T40098 (14), T10060A (15), T40011 (15)
ENGINE CODES	BYT, BZB, CABA, CABB, CABD, CADA, CAEA, CAEB, CAWA, CAWB, CBFA, CCTA, CCZA, CCZB, CCZC, CDA, CDAB, CDHA, CDHB, CDNB, CDNC, CDND, CESA, CETA, CFKA, CGYA, CJEB, CJBA, CJSB.

TURBO TIMING SET VW / AUDI 1.8 / 200L

53287 245,00€

GASOLINA/PETROL

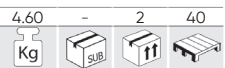

APPLICATIONS	VOLKSWAGEN AUDI	1.8 / 2.0 TURBO
OEM TOOLS	T10355 (1), T40196 (2), T40271 (3) (4), T10352 (5), T10352/1 (6), T10352/2 (7), T10368 (7), T40267 (8), T10354 (9), T40265 (10), T40011 (11) (14), T40098 (12), T10060A (13)	
ENGINE CODES	BYT, BZB, CABB, CABD, CADA, CAEA, CAEB, CAWA, CAWB, CBFA, CCTA, CBFA, CCTA, CCZA, CCZB, CCZC, CDA, CDAB, CDHA, CDHB, CDNB, CDNC, CDND, CESA, CETA, CFKA, CGYA, CJEB, CJSB, CJSB.	

DIESEL ENGINE TIMING CRANK LOCKING TOOLS VW / AUDI

53275

35,50€

GASOIL/DIESEL

0,70	5	10	330
Kg	SUB	11	11

APPLICATIONS

DODGE: Caliber (06-11)
 FORD: Galaxy (02-06)
 MITSUBISHI: Grandis (05-10), Lancer (05-10), Outlander (07-10).
 SEAT: Alhambra (00-15), Altea/Altea XL (04-15), Cordoba (02-09), Ibiza (02-15), Leon (00-13), Toledo (04-11).
 SKODA: Fabia (00-14), Fabia II (07-15), Octavia (00-10), Octavia II (04-15), Praktik (10-15), Rapid (11-15), Roomster (07-15), Superb (02-08), Superb II (08-15), Yeti (09-14).
 AUDI: A1 (10-15), A2 (00-06), A3 (01-13), A4/Allroad (01-16), A5 (08-15), A6 (11-14), TT (08-14), Q3 (11-15), Q5 (08-15), A6 (10-14).
 VOLKSWAGEN: Amarok (10-16), Beetle (02-15), Bora (02-08), Caddy/Maxi (03-15), EOS (06-15), Fox (05-11), Golf (02-15), Golf Plus (05-14), Jetta (05-15), Lupo (02-05), Passat/CC (02-15), Polo (99-14), Scirocco (08-14), Sharan (02-15), Tiguan (07-15), Touran (03-15), Transporter (03-17).

OEM TOOLS

DODGE: 9882, 9883.
 FORD: 310-085/23-059, 303-1054.
 MITSUBISHI: MB995206, MB995208, MB995209.
 VAG: T10100 (4), T10050 (1), 3359 (3/6)/T20102, T10115 (3), T10060A (2)/T40098, T20167.

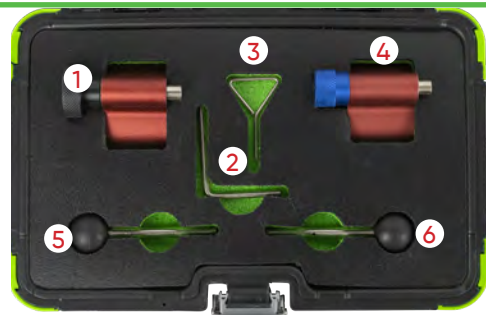

ENGINE CODES

1.2D TDi CR: CFWA.
 1.4D TDi PD: AMF, BAY, BMS, BNM, BNV, BWB.
 1.6D TDi CR: CAYA, CAYB, CAYC, CAYD, CAYE, CLNA.
 1.9D TDi PD: AJM, ANU, ARL, ASZ, ATD, AUY, AVB, AVF, AVQ, AWX, AXB, AXC, AXR, BJB, BKC, BLS, BLT, BMT, BPZ, BRM, BRR, BRJ, BRU, BSU, BSV, BSW, BTB, BVK, BXE, BXF, BXJ.
 2.0D TDi CR/TDi PD: AZV, BDJ, BDK, BEW, BGW, BHW, BKD, BKP, BKQ, BLB, BMA, BMM, BMN, BMP, BMR, BNA, BPW, BRA, BRC, BRD, BRE, BRF, BRT, BSS, BST, BSY, BUY, BUZ, BVA, BVE, BVF, BVG, BVH, BWC, BWV, CAAA, CAAB, CAAC, CAAD, CAEE, CAGA, CAGB, CAGC, CAHA, CAHB, CBAA, CBAB, CBAC, CBBA, CBBB, CBDA, CBDB, CBDC, CBEA, CCHA, CCHB, CDBA, CDCA, CEGA, CFCA, CFFA, CFFB, CFFD, CFFE, CFGB, CFGC, CFHA, CFHB, CFHC, CFHD, CFHE, CFHF, CFJA, CGLA, CGLB, CGLC, CGLD, CJAA, CJCB, CJCC, CLCA, CLCB, CLJA, CLLA, CNEA, ECD, ECD/BSY, ECD/BYL, ECE/BWD.

TIMING BELT SETTING KIT FOR AUDI / VW / SEAT / SKODA

53649

89,00€

GASOLINA/PETROL

3,48	-	2	48
Kg	SUB	11	11

APPLICATIONS

AUDI SEAT SKODA VW

OEM TOOLS

T10340 (1), T10476 (2), T10477 (3), T10487 (4), T10494 (5), T10499 (6)

ENGINE CODES

1.0 MPI: CHYA.
 1.0 TSI: CHZE, CHZC, CHZA, CHZB, CHZC, CHZD, CHZJ.
 1.2 TSI: CJZB, CJZC, CYVA, CJZA, CJZD, CYVB.
 1.4 TSI: CZCC, CMBA, CZCA, CHPA, CPTA (ACT), CZDA, CVNA, CZIA (ACT).

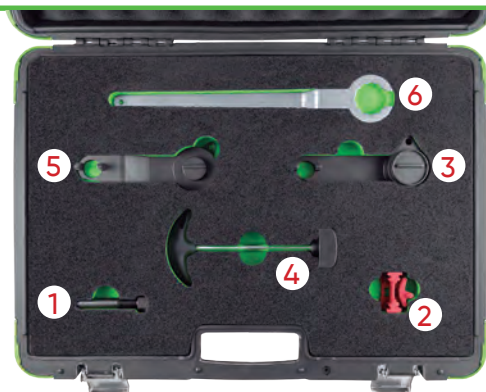

TIMING TOOL SET FOR VAG 1.6/ 2.0L TDi PD COMMON RAIL DIESEL ENGINES

53288

72,00€

GASOIL/DIESEL

2,05	-	5	135
Kg	SUB	11	11

APPLICATIONS

SEAT: Exeo, Leon, Altea, Toledo, Ibiza.
 VOLKSWAGEN: Jetta, Touran, Golf, Golf Plus, Polo, Passat, Tiguan, Scirocco.
 SKODA: Roomster, Fabia, Praktik, Octavia, Yeti, Superb.
 AUDI: A1, A3, A4, A5, Q5, A6, TT.

OEM TOOLS

T10264 (1), T10265 (2), T20102 (3), T10052 (4), T10051 (5), T10255 (6), T10050 (7), T10100 (8), T40098 (9)

ENGINE CODES

1.2 TDI CR, 1.6 D TDI CR, 2.0 D TDI CR

CAGA, CAGB, CAGC, CAHA, CAHB, CFHC, CBAA, CBAB, CFFB, CGLA, CGLB, CJCA, CJCB, CAAA, CBAA, CBAB, CBAC, CBBA, CBBB, CBDA, CBDB, CBDC, CCHA, CEGA, CJAA, CAAB, CAAC, CFJA, CFWA, CAYB, CAYC, CAYA.



VAG VIBRATION DAMPER ASSEMBLY TOOL

54218

142,00€

GASOLINA/PETROL

1,95	-	5	135
Kg	SUB	11	11

APPLICATIONS

AUDI, SEAT, SKODA, VOLKSWAGEN

OEM TOOLS

T10531/1 (1), T10531/2 (2), T10531/3 (3), T10531/4 (4)

ENGINE CODES

1.8L TFSI:
 BZB, CDAA, BPU, BYT, CABA, CABB, CDHA, CDHB, CABD, DAJB, CJSA, CJSB, CJEB, CJEE, CJED, CYGA, CDAC, CJSC, CGYA, DAJA
 2.0L TFSI:
 CAWB, CCZA, CBFA, CCTA, CDNB, CDNC, CDND, CJXA, CJXE, CJXH, CHHB, CHHA, CULA, CFKA, DEDA, CHJA, CAWA, CCZC, CCZD, CPSA, CJKA, CJKB, CESA, CETA, CFPA, CNCD, CPLA, CYRB, CYRC, CNCE, CYNB, CYPB, CULB, CULC, CNCB, CWZA, CJXF, CJXC, CJXB, CJXG, CHHC, CCZB



PETROL ENGINE TIMING KIT RENAULT 1.4 / 1.6 / 1.8 / 2.0 16V BELT DRIVE

53289 45,00€

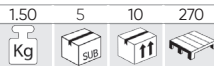

GASOLINA/PETROL

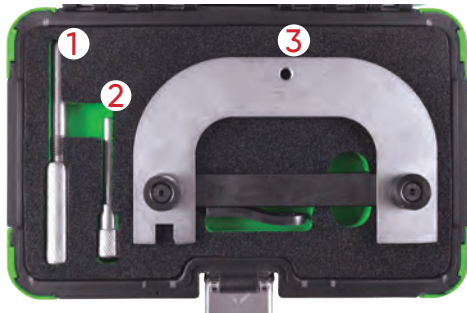

APPLICATIONS

RENAULT: Espace/Grand Espace (98-02), Espace/Grand Espace IV (02-10), Kangoo/Trekka (01-09), Laguna (98-01), Laguna II (01-07), Laguna III (07-13), Megane (99-03), Megane II (02-10), Megane III/Sport (08-13), Megane/Scenic (99-00), Scenic/RX4 (99-03), Scenic/Grand Scenic II (03-09), Trafic II (01-11), Twingo II (08-14), Vel Satis (00-10), Wind (10-14)
 DACIA: Logan/MCV (05-11).
 NISSAN: Kubistar X76 (03-09), Primastar (02-11).
 VAUXHALL/OPEL: Jetta, Touran, Golf, Golf Plus, Polo, Passat, Tiguan, Scirocco.

OEM TOOLS

Mot1489 (1), Mot1054 (2), Mot1496 (3)

ENGINE CODES

1.4 16v K4J: 730, 732, 740.
 1.6 16v K4M: 752, 753, 760, 761, 764, 788, 812, 813, 854, 856.
 1.8 16v F4P: 720, 722, 760, 770, 771, 772, 773, 774, 775.
 2.0 16v F4R: 700, 701, 712, 713, 714, 715, 720, 722, 730, 732, 736, 738, 740, 741, 744, 746, 747, 762, 763, 764, 765, 766, 767, 770, 771, 780, 790, 791, 792, 820, 830, 832, 867.
 2.0 16v F4R(1): 720, 722, 764, 765, 774, 776, 784, 786, 787, 794, 795, 796, 797, 800, 802, 810, 811, 870, 872, 874, 886, 887, 896, 897.

ENGINE TIMING TOOL SET RENAULT

53291 68,00€



GASOLINA/PETROL

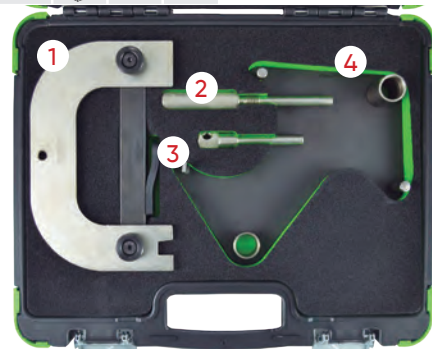

APPLICATIONS

RENAULT: Clio, Laguna, Megane

OEM TOOLS

MOT1496 (1), MOT1489 (2), MOT861/1863 (3), MOT1490(4)

ENGINE CODES

K4J, K4M, F4P, F4R.

ENGINE TIMING TOOL SET FOR RENAULT / VOLVO 16V / 20V

53290 51,00€



GASOLINA/PETROL

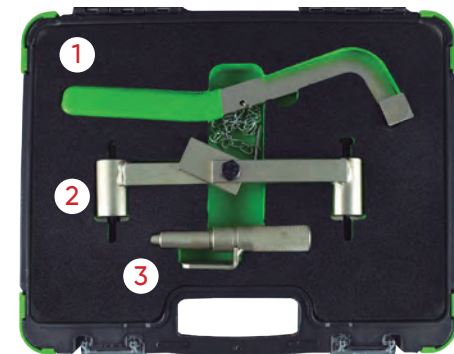

APPLICATIONS

RENAULT: Laguna 2.0 16V / 2.5 20V (1996-1999), Safrano 2.0 16V / 2.5 20V (1996-2001)
 VOLVO: 850 (1992-1997), C70 (1998-2002), S40 (1996-2004), V40 (1996-2004), S60 (2001-2005), S70 (1997-2000), S80 (1999-2005).

OEM TOOLS

MOT1348 (1), MOT1337 (2), MOT1340 (3)

ENGINE CODES

RENAULT: N7Q 704/710/711(2.0 16V),N7U 700/701(2.5 20V).
 VOLVO: B4164S, B4164S2, B4184S, B4184S2, B4184S3, B4184S9, B4184S10, B4194T, B5194T2, B420S4, B4204S2, B4204T, B4204T2, B4204T3, B4204T5, B5202Fs, B5204FT, B5204T2, B5204T3, B5204T4, B5204T5, B5234FS, B5204FT, B5234T3, B5234T4, B5234T5, B5234T6, B5234T7, B5234T8, B5234T9, B5244S, B5244S2, B5244SG, B5244SG2, B5244T, B5244T3, B5244T4, B5244T5, B5244T7.

DIESEL ENGINE LOCKING KIT RENAULT / NISSAN 1.6 DCI

53523 91,00€

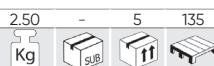

GASOIL/DIESEL



APPLICATIONS

RENAULT: Espace/Grand Espace IV (06-10), Kaleos (08-11), Laguna II (05-07), Laguna III (07-12), Master III (10-12), Magane II (06-10), Scenic/Grand Scenic II (06-09), Scenic/Grand Scenic III (09-12), Trafic II (06-12), Vel Satis (05-10)
 NISSAN: Primastar X83 (06-10), Qashqai/Qashqai+2 J10 (07-10), X-Trail T31 (07-12).
 VAUXHALL / OPEL: Movano-B (10-12), Vivaro (06-12).

OEM TOOLS

MOT1989 (1), MOT1970 (2), MOT1770, MOT1773, EN-48330, EN-48332, EN-48334, EN-48831, KM-6130

ENGINE CODES

M9R 2.0dCi: 610, 615, 630, 700, 721, 740, 742, 760, 761, 762, 763, 780, 782, 784, 786, 788, 800, 802, 803, 805, 808, 816, 830, 832, 833.
 M9T 2.3dCi: 670, 672, 676, 678, 680, 686, 690, 692, 694, 698.

VAT not included

ENGINE TIMING TOOL SET FORD

53293 134,00€

GASOLINA/PETROL

GASOIL/DIESEL

4,15 - 2 42
Kg SUB 11

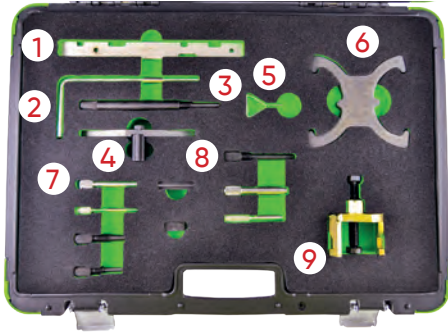

APPLICATIONS

FORD B-Max (12-17), C-Max (07-17), Cougar (98-01), Courier (00-02), Escort (94-98), Fiesta (95-17), Focus (98-17), Focus C-Max (03-07), Fusion (02-12), Galaxy (06-15), Grand C-Max (10-17), Kuga (08-15), Maverick (01-07), Mondeo (93-15), Orion (94-94), Puma (97-02), S-Max (06-15), Tourneo Connect (02-15), Transit (06-11), Transit Connect (02-16), EcoSport (13-15), Tourneo Courier (14-15), Grand Tourneo Courier (13-15).

OEM TOOLS

303-376 (21-162B) (1), 303-1059 (2), 303-193 (21-104) (3), 303-393-01 (4), 303-1054 (5), 303-1097 (6), 303-748 (7), 303-734 (21-262) (8), 303-651 (21-229) (9), 303-393A (21-168) / 303-393-02 / 303-507 (21-210) / 303-620 (21-163) / 303-732 (21-260) / 303-735 (21-263).

ENGINE CODES

PETROL: AODA/B, ASDA, ASDB, CFBA, CGBA/B, CHBA/B, CJBA/B, CSDA/B, DHA, DHB, DHC, DHG, DHE, DHF, DHG, EDBB, EDBD, EDDB, EDDC, EDDD, EDDF, EYDB, EYDC, EYDD, EYDE, EYDF, EYDG, EYDI, EYDJ, EYPA, EYPC, F8JA, F8JB, FHA, FHD, FHE, FHF, FUJA, FUJB, FXDA/C, FXDB/D, FXJA, FXJB, FYDA/C, FYDB/D, FYJA, FYJB, HWDA, HWDB, LIF, LIJ, LIL, LIN, LIQ, LIT, LIV, LIW, M7JA, M7JB, MHA, MHB, NGA, NGB, NGC, NGD, QQDA/B/C, QQDB, RKA, RKB, RKF, RKH, RKJ, RKK, HXDA.
DIESEL: F6JA, F6JB, F6JC, HHJA, HHJB, G8DA, HHDA, HHDB, RTN, RTQ, RTP, C9DC, BHDA/B, BHPA, C9DA/B, F9DA/B, FFBA, FFDA, HCPA, HCPB, KKDA, P7PA, P9PA, QYWA, R2PA, R3PA, RWPA, G6DA, G6DB, G6DC, AZWA, QXWA.

ENGINE CAMSHAFT SPROCKET LOCKING TOOL FOR FORD 1.5T

54223 149,00€

GASOIL/DIESEL

2,40 - 5 135
Kg SUB 11

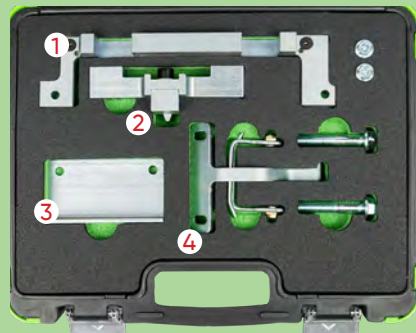

APPLICATIONS

FORD 1,5L Duratec, EcoSport, Fiesta, Focus

OEM TOOLS

303-1639(1), 303-1643(2), 303-1647(3), 303-1648(4)

ENGINE CODES

2.2 / 2.5

5:1 TORQUE MULTIPLIER SET FOR FORD ECOBOOST ENGINES

54260 277,00€

7,50 - 1 240
Kg SUB 11



1.0 EcoBoost 2.0 Durator-TDCi
1.0 Duratec 2.0 EcoBlue Diesel
2.0 Duratec

FORD ENGINE TIMING TOOL SET

53653 207,00€

GASOLINA/PETROL

5,50 - 2 48
Kg SUB 11

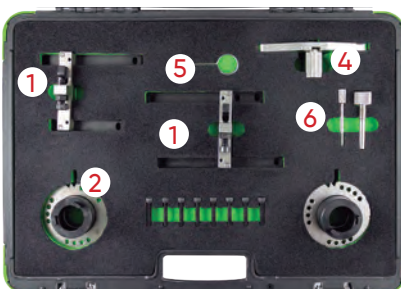

APPLICATIONS

FORD: Fiesta, Focus, B-MAX, EcoSport.

OEM TOOLS

303-1605 (1), 303-1606 (2), 303-1604 (3), 303-1602 / 503-393A / (21-168) (4), 303-1054 (5), 303-732 (6)

ENGINE CODES

M1DD, M1JA, M1JC, M1JE, M1JHM1JJ, M1DA, M2DA, M2DB, M2DC, SFDBSFJA, SFJB, SFJC, SFJD

ENGINE TIMING TOOL SET FIAT, FORD, OPEL, SUZUKI 1.3L

54211 74,00€

GASOIL/DIESEL

1,95 - 5 135
Kg SUB 11

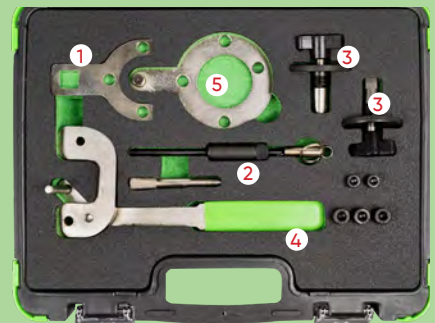

APPLICATIONS

Fiat: Punto (2003-2007) / Panda (2003-2009) / Idea (2004-2006) / Doblo (2004-2006).
Ford: KA.
Vauxhall / Opel: Agila (2003-2008) / Corsa C (2003-2007) / Corsa D (2006-2009) / Combo C (2003-2009) / Astra H (2004-2009)
Tigra B (2004-2009) / Meriva (2004-2009).
Suzuki: Ignis (2003-2009) / Wagon R (2003-2009) / Swift (2003-2010).

OEM TOOLS

1871000200/303-1469/KM-662-C (1), EN 46785/KM 955/09912-38300 (2), 1871000900/1860985000/303-1472/EN 46781/09917-68610(3), 1870900400 (4), 1870900300 / 303-1468 (5)

ENGINE CODES

Fiat: 1.3 JTD 188A9.000 / 169A.000 / 188A8.000 / 199A3.000.
Ford: 1.3 TDCi.
Vauxhall / Opel: 1.3 CDTi Z13DT / Z13DTH / Z13DTJ.
Suzuki: 1.3 CDTi Z13DT.

INJECTION PUMP REMOVER/ INSTALLER SET FOR FORD 2.0

54224 64,50€

GASOIL/DIESEL

1,75 - 5 135
Kg SUB 11

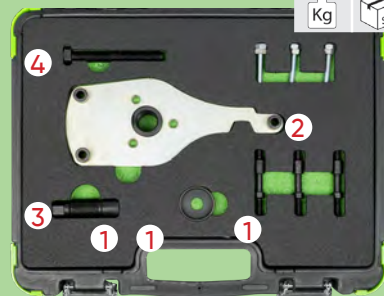

APPLICATIONS

FORD: Transit (17-18), Tourneo Custom (16-18), Transit Custom (16-18)

OEM TOOLS

303-1635(1)/3, 3.3--1635(2)/1, 303-1635(3)/2, 303-1635(6/4)

ENGINE CODES

YLFS, YMFS, YNFS, YLF6, YMF6, YNF6, YLR6, YMR6 and YNRS.

ENGINE TIMING TOOL SET FORD 2.0 ECOBLUE

54204 124,00€

2.55 - 5 135
Kg SUB

GASOIL/DIESEL

APPLICATIONS	Ford Edge, Focus, Galaxy, S-MAX (from 2018); Kuga, Mondeo, Ranger (desde 2019); Transit, Transit Custom and Tourneo Custom (desde 2016); todos con motor EcoBlue TDCi ; AWD, FWD y RWD.
OEM TOOLS	303-1637(1), 303-1650(2), 303-1643(3).
ENGINE CODES	BCCC,YLCB,YLDA,YLF6,YLFA,YLFB,YLFS,YLR6,YLRA,YM-CB,YMF6,YMFA,YMFB,YM-FS,YMHA,YMRA,YNCA,YNF6,YNFA,YNFB,YNFS,YNR6,YNRA

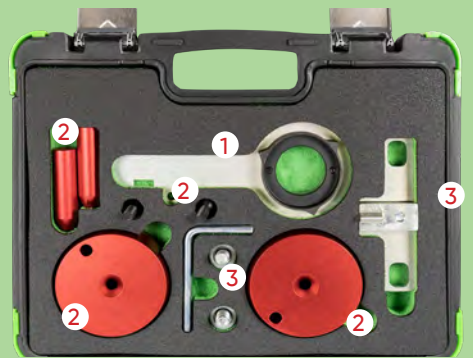

ENGINE TIMING TOOL SET FORD

54201 37,60€

1.05 5 10 240
Kg SUB

GASOLINA/PETROL

APPLICATIONS	Ford: C-MAX(07 - 10), C-MAX/Grand C-MAX(10-18), Fiesta(08-18), Focus/Focus C-MAX(04-11), Focus(11-18), Mondeo(07-15)
OEM TOOLS	303-1097 (1), OEM 303-1054 (2), OEM 303-1059, 303-1270, 0188X, 999-7121 (3), OEM 303-748, 999-7152, 21-259 (4), OEM 303-735, 999 7122, 0187B, 0189B, 0132AJ, 21-263, 0188M, MOT 1430, 303-1277, 0194B (5)
ENGINE CODES	11.6.TI-VCT HXDA (2003-2007), 2.0 TDCI , G6DA, G6DB, G6DC 2003-2007

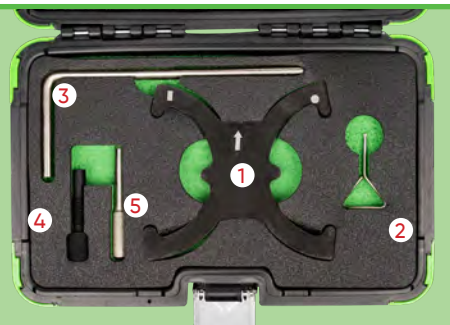

ENGINE TIMING TOOL SET FORD/MAZDA 2.2, 3.2 TDCI

54209 29,70€

0.85 5 10 240
Kg SUB

GASOIL/DIESEL

APPLICATIONS	Ford_Ranger 3.2L (2011-2016) Ford_Ranger 2.2L (2011-2015) Ford_Transit 2.2L (2006-2016) Ford_Everest 3.2L (2015) Ford_Ranger 3.2L (2011) Mazda BT-50 (2011) Mazda BT-50 3.2L (2011-2016)
OEM TOOLS	303-675/21-234,303-698/21-251 (1), 303-1587(2)
ENGINE CODES	CYFA,CYFB,DRFA,DRFB,P8FA,P8FB,PGFA,PGFB,QVFA,QWFA,SRFA,SRFB,SRFC,SRFD,SEFE,UHFA,CYFC,DRFC,USRA

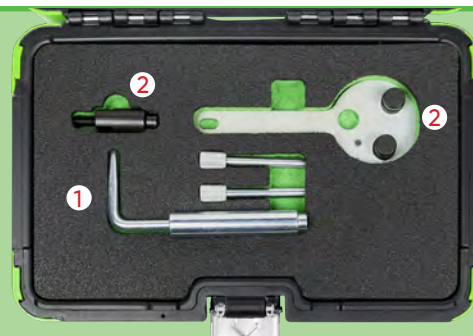

ENGINE TIMING TOOL SET FORD 2.0 ECO BOOST SCTI& TI-VCT

54208 76,00€

1.95 - 5 135
Kg SUB

GASOLINA/PETROL

APPLICATIONS	FORD: Galaxy(2010) Mondeo (2010) S Max (2010) Focus(2011)
OEM TOOLS	303-748 (1), 303-1504 (2), 303-1565 (3), 303-1521 (4)
ENGINE CODES	TNWA, TNWB, TPWA, TNBA, TPBA, MGDA, XQDA

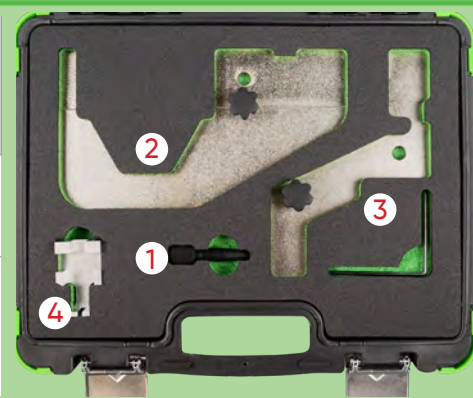

ENGINE TIMING TOOL SET FORD 1.8TDDI / TDCI

53295 77,00€

GASOIL/DIESEL

2.10 - 5 165
Kg SUB

APPLICATIONS	C-Max (07-10), Courier (00-02), Fiesta (00-02), Focus (98-11), Focus C-Max (03-07), Galaxy (06-10), Mondeo (07-10), S-Max (06-14), Tourneo Connect (02-13), Transit Connect (02-13).
OEM TOOLS	303-193 (21-104) (1), 303-393 (21-168) (2), 303-376 (21-162B) (3), 303-652 (21-230) (4), 310-095 (23-067) (5)
ENGINE CODES	1.8D TDCi: BHPA, F9DA, F9DB, FFBA, FFDA, FFWA, HCPA, HCPB, KHBA, KKDA, KKDB, P7PA, P9PA, P9PB, QYBA, QYWA, R2PA, R3PA, RWPA, RWPC. 1.8D TDCi ECOnetic: KHBA. 1.8D Tdi: BHDA, BHDB, BHPA, C9DA, C9DB, C9DC. 1.8D Turbo: C9DC, RTN, RTP, RTQ.



FORD ENGINE TIMING TOOL

53324 12,50€

GASOLINA/PETROL

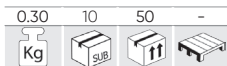

APPLICATIONS

FORD: B-Max (15-17), C-Max (07-10), Cougar (98-01), Fiesta (95-17), Focus (98-11), Focus C-Max (03-07), Fusion (02-12), Galaxy (06-15), Maverick (01-07), Mondeo (93-15), Puma (97-02), S-Max (06-15), Tourneo Connect (02-06), Transit (06-12), Transit Connect (02-06).
 MAZDA: 121 ZQ (95-00), 2 DY (02-07), 3 BK (03-09), 3 BL (09-15), 5 CR (05-10), 5 CW (10-12), 6 GG/GY (02-07), 6 GH (07-15), MPV LW (02-05), MX-5 NC (05-16), Tribute EP (04-06).
 VOLVO: C30 (06-13), S40 (06-12), S80 (07-11), V50 (04-12).

OEM TOOLS

FORD: 303-1054, 303-507 (21-210), 303-620 (21-163), 303-574, 303-748, 303-376 (21-162B), 303-376B
 MAZDA: 49 JE01 061, 303-574, 49 JE02 061, 303-465, 49 JE01 054
 VOLVO: 999 7152, 999 7151.

ENGINE CODES

1.4 / 1.6

ENGINE TIMING TOOL KIT FORD / MAZDA

53294 119,00€

GASOIL/DIESEL

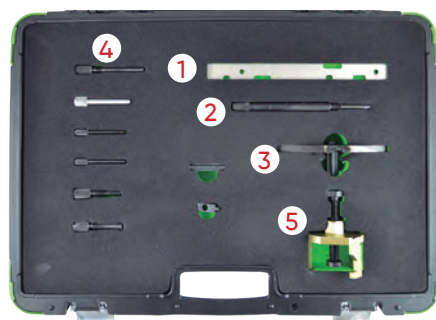
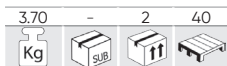

APPLICATIONS

FORD: Courier (00-02), C-Max (03-10), Fiesta (02-11), Focus (98-11), Fusion (02-11), Galaxy (06-10), Kuga (06-10), Mondeo (07-10), S-Max (06-10), Tourneo Connect (02-13), Transit Connect (02-13).
 PEUGEOT: Bipper (08-10) Dispatch/Jumpy III (07-12) Expert III (07-12) Nemo (08-10) Partner I/II (05-11) Partner III (08-16) 107 (05-10) 1007 (05-10) 206 (01-12) 206+ (09-13) 206 CC (05-07) 207 (06-13) 207 CC (07-15) 208 (11-15) 307 (01-08) 308 (07-15) 308 CC (09-15) 407 (05-11) 508 (04-15) 2008 (13-15) 3008 (09-15) 4008 (12-15) 5008 (09-15).
 MAZDA: 2 (02-15), 3 (09-14).
 CITROËN: C1 (05-10), C2 (03-10), C3 I/II (02-10), C3 III (10-15), C3 Pluriel (04-10), C3 Picasso (09-12), C4 (04-11), C4 II (11-15), C4 Picasso (06-12), C4 Grand Picasso (10-12), DS3 (09-12), DS4 (11-12), DS5 (12-15), C5 II (04-08), C5 III (04-12), Xsara II (02-04), Xsara Picasso (04-10).

OEM TOOLS

FORD: 303-376B (1), 303-193 (2), 303-393 (3), 303-732 (4), 303-651 (5), 303-393/01, 303-1059, 303-734, 303-735.
 MAZDA: 303-732, 303-734, 303-735.
 PSA: 0194-A, 0194-C, 0194B.

ENGINE CODES

1.4D TDCi/Hdi: DV4TD(8HT), DV4TD(8HX), DV4TD(8HZ), DV4TD(8HW), DV4TED4(8HX), DV4TED4(8HV), DV4TED4(8HY), DV4C(8HP), DV4C(8HR), DV4TED(8HS), F6JA, F6JB, F6JC.
 1.6D TDCi/HDi: DV6TED4(9HZ), DV6ATED4(9HX), DV6TED4(9HY), DV6DTE(9HP), DV6C(9HR), DV6CATED(9HX), DV6C(9HL), DV6TED(9HP), DV6ATED(9HY), DV4TED4(9HV), DV6TED4(9HX), DV6C(9HD), DV6C(BHX), DV6C(BHZ), DV6(9HR), DV6BTED4(9HW), DV6DTE(9HJ), DV6ETED(9HN), DV6TED4BU(9HS), DV6BTED4(9HT), DV6BUTED4(9HT), DV6TED4B(9HV), DV6UTED4(9HX), DV6TED(9HD), DV6UTED4(9HU), DV6D(9HP), DV6TE-D4(9HV), DV6C(9HD), DV6TED4(9HW), DV6AT(9HX), DV6ATED(9HX), DV6CTED(9HC), DV6AUTED4(9HX), DV6TED4B, DV6DTE(9HF), HHJA, HHJB, G8DA, G8DB, HHDA, HHDB, MZ-CD, Y6.
 1.8D TDCi/HDi: BHPA, C9DA/B, FFBA, G6DA, G6DB, G6DC, HCPA, HCBP, KKDA, P7PA, P9PA, R2PA, R3PA, RWPA.
 1.8ci: C9DC, RTN, RTQ.
 1.8D Tdi: C9DA/B, C9DC.
 2.0D TDCi/HDi: AZWA, G6DA, G6DB, G6DC, RHE(DW10CTED4), QXWA, QXWB.

DIESEL SETTING LOCKING AND INJECTION PUMP KIT FOR FORD / JAGUAR DURATORQ

53296 60,00€

GASOIL/DIESEL

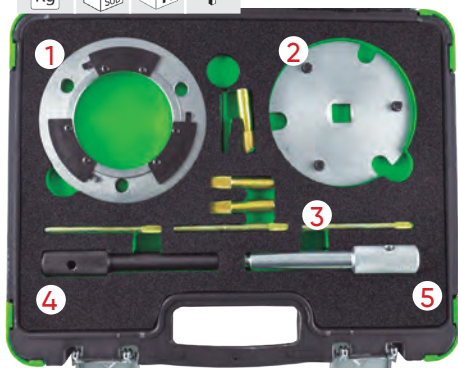

APPLICATIONS

FORD: Mondeo (00-07), Transit (00-14).
 CITROËN: Relay, Jumper III (06-13).
 FIAT: Ducato (06-11).
 JAGUAR: X-Type (03-10).
 PEUGEOT: Boxer III (06-12).
 LAND ROVER: Defender Td4 (06-11).
 LDV: Convoy (02-06).

OEM TOOLS

303-1151 (1), 303-679A/21-238 (2), 303-732 (3), 303-675/21-234 (4), 303-698/21-251 (5)

ENGINE CODES

12.0D Di/TDci/TDCi: ABFA, D3FA, F3FA, D5BA, D6BA, F1FA, FMBA, FMBA, HJBA, HJBB, HJBC, HJBE, N7BA, N7BB.
 2.2D TDCi/ECONetic: BG, CYFA, CYFB, CYFC, DRFA, DRFB, DRFC, P8FA, P8FB, PGFA, PGFB, QJBA, QJBA (BG), QJBB, QJBC, QJBD, QVFA, QWFA, SRFA, SRFB, SRFC, SRFD, SRFE, UHFA.
 2.2D HDi/JTD: P22DTE (4HM), P22DTE (4HU), P22DTE (4HV).
 2.4D Di/TDCi: DOFA, D2FA, D2FB, D4FA, F4FA, FXFA, H9FA, H9FB, H9FD, JXFA, JXFC, PHFA, PHFC.
 2.4D TD/Tdi: ZSD 424.
 2.4D Td4: 244DT.

ENGINE TOOL SET JAGUAR / LAND ROVER

53297 45,00€

GASOIL/DIESEL

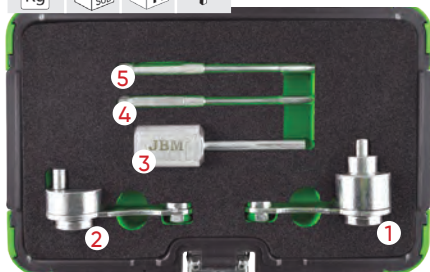
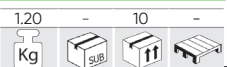

APPLICATIONS

JAGUAR: MS TypeTDVi.
 LAND ROVER: Discovery 2.7 TDV6.
 RANGE ROVER: Sport 2.7 TDV6.

OEM TOOLS

303-1117 (1), 303-1116 (2), 303-1132 (3), 303-1126 (4) (5)

ENGINE CODES

276DT, 306DT.

VAT not included

ENGINE TIMING TOOL SET FOR LAND ROVER

53298 91,00€

2.60 - 5 160
Kg SUB

GASOIL/DIESEL

APPLICATIONS DIESEL ENGINES: 200 TDI. 300 TDI. 2.5

- New EDC Manual Transmission Timing Pin.
- 200 TDI. 300 TDI. 2.5 Diesel Engines.
- Crankshaft Damper Puller.
- Injection Pump Gear Locking Tool.
- Injection Pump Timing Pin 200 / 300 TDI.
- Flywheel Timing Tool 200 / 300 TDI.
- DPS Pump Timing Tool 2.5.
- Flywheel Timing Tool 2.5.
- EDC Timing Pin-30Q manual gearbox.



ENGINE TIMING TOOL SET OPEL / FORD / FIAT / ALFA ROMEO / LANCIA / SUZUKI

53452 26,50€

0.80 5 10 240
Kg SUB

GASOIL/DIESEL

APPLICATIONS VAUXHALL/OPEL 1.3 CDTi: Agila, Corsa, Combo (03-08), Astra-H(05-08), Meriva, Tigra-B(04-08)
SUZUKI 1.3 DDiS: Ignis, Wagon R(03-08), Swift(04-08)
FORD: 1.3 TDCi
FIAT/ALFA ROMEO/LANCIA: 1.3 JTD Multijet

OEM TOOLS 104-A EN 46781 (1) , EN 46785 (2)

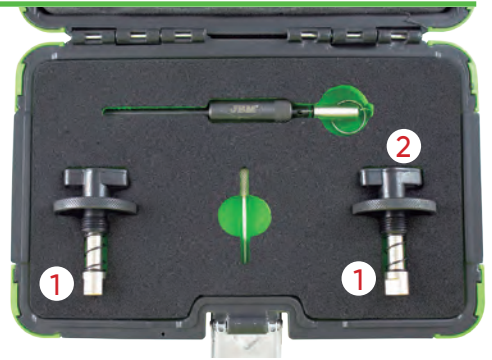

ENGINE TOOL TIMING SET FOR OPEL / VAUXHALL / CHEVROLET 2.0CDI

53300 41,00€

1.25 - 10 270
Kg SUB

GASOIL/DIESEL

APPLICATIONS OPEL
VAUXHALL
CHEVROLET

OEM TOOLS EN-48245 (1), EN-48246 (2),
205083060 (3) (4) (5) (6)

ENGINE CODES OPEL / VAUXHALL: Z20DM, Z20DMH
CHEVROLET: LLWZ20DMH, RA 420 , Z20Si, Z 20S3, Z 20S4, Z 20S5

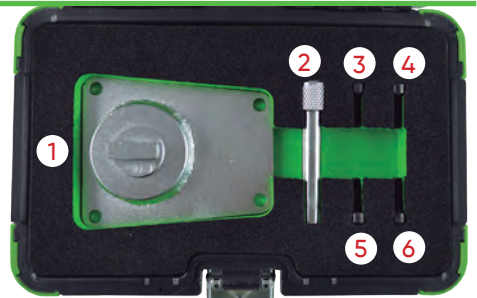

TIMING TOOL KIT FOR OPEL / VAUXHALL (GM)

53299 291,00€

6.70 - 2 42
Kg SUB

GASOIL/DIESEL

APPLICATIONS OPEL / VAUXHALL

OEM TOOLS EN-46788 (1), KM927 (2), EN-46789 (3), KM929 (4), EN-46785 (5), EN-46788 (6), 1 860 985 000 (7), KM932 (8), KM933 (9), EN-49978 (10), KM933 (11)

ENGINE CODES 1.3 CDTi 16V, 1.9 CDTi, 2.0 DTi, 2.2 DTi.

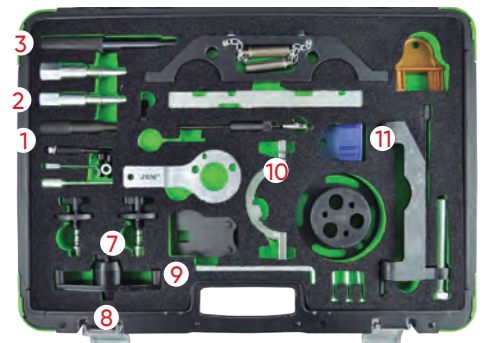

ENGINE TIMING TOOL SET FOR FIAT, OPEL, ALFA 1.9, 2.4L 16V

54216 49,00€

1.75 - 5 135
Kg SUB

GASOIL/DIESEL

APPLICATIONS Opel 1.9, Alfa-Romeo 1.9-2.4 L diesel, Fiat 1.9- 2.4 L diesel

OEM TOOLS Opel EN-46788 / Fiat 1.860.905.000 / 1.860.905.010 (1)
Fiat 1.860.898.000 (2)
Opel EN-46789 / Fiat 1.870.896.900 (3)
Opel KM 6130 / KM 6349 (4)

ENGINE CODES Opel 1.9 CDTi Z19DT, Z19DTH, Z19DTJ
Alfa-Romeo 1.9 y 2.4 L : 323.02, 371.01, 342.02, 325.01, 362.02, 182B9.000, 937A2.000, 937A3.000, 192A5.000, 192B1.000, 937A4.000, 937A5.000, 939A2.000, 939A1.000, 939A7.000, 939A8.000, 839A6.000, 841C.000
Fiat 1.9 y 2.4 L : 182B4.000, 182B9.000, 185A6.000, 186A6.000, 186A8.000, 186A9.000, 188A2.000, 188A7.000, 188B2.000, 192A1.000, 192A3.000, 192A5.000, 192A8.000, 192A9.000, 192B4.000, 192B5.000 198A2.000, 198A3.000, 198A6.000, 199A5.000 223A7.000, 937A5.000, 939A1.000, 939A2.000 939A3.000, 939A7.000



PEL / VAUXHALL 1.0 1.2 1.4 TURBO ENGINE TIMING TOOL SET

53651

91,00€

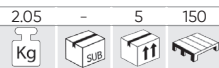

GASOLINA/PETROL



APPLICATIONS	PEL: Adam, Ampera, Astra-J, Aveo, Corsa-D, Insignia, Meriva-B, Mokka, Zafira-C Tourer
OEM TOOLS	EN 49977-100 (1), EN 49977-200 (2), EN 49978 (3), KM 952 (4), KM 953-A (5), KM 955-1 (6), KM 955-2 (7).
ENGINE CODES	1.0: A10XEP (LDB) 1.2: A12XEL (LWD), A12XER (LDC) 1.4: A14XEL (L2Z), A14XER (LDD), LDU A14NEL (LUH), A14NET (LUJ), Twinport / ecoFLEX engines A14XFL (LUU), A14NEL (LDD), A14NEL (LUJ), A12XEL (L2Q)

ENGINE TIMING TOOL SET FOR OPEL 1.0 / 1.2 / 1.4

53301

44,00€

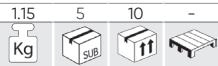

GASOLINA/PETROL

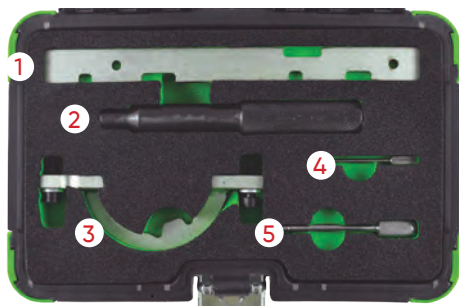

APPLICATIONS	SUZUKI: Wagon R (05-08). VAUXHALL / OPEL: Agila (00-08), Astra-G (98-06), Astra G Classic II (03-10), Astra-H (04-11), Combo (04-12), Corsa-B (97-00), Corsa-C (00-07), Corsa-D (06-12), Meriva-A (04-10), Tigra-B (04-10).
OEM TOOLS	KM-953/09919-58310 (1), KM-952/09912-38310 (2), KM-954/09919-08310 (3), KM-6130 (4), KM-955/09919-58320 (5)
ENGINE CODES	1.0 12v: X10XE, Z10XE, Z10XEP. 1.2 16v: X12XE, Z12XE, Z12XEP. 1.4 16v/ecoFLEX: Z14XEL, Z14XEP.

ENGINE TIMING TOOL SET FOR VAUXHALL, OPEL 1.3 CDTI

54221

111,00€

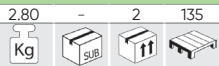

GASOIL/DIESEL



APPLICATIONS	Vauxhall/ Opel 1.3 CDTI Corsa E Diesel Engine From 2015
OEM TOOLS	KM-662-C(1), EN-50515(2), EN-51500(3), EN-46775(4), KM-955-1(5), EN-46785.(6)
ENGINE CODES	LKU B13DTE, LKU B13DTR

ENGINE TIMING TOOL SET FOR VAUXHALL, OPEL, SAAB 2.0, 2.2 DTI

54217

104,00€



GASOIL/DIESEL

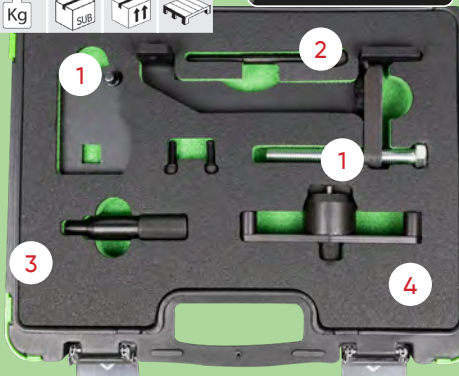

APPLICATIONS	Vauxhall/Opel: Astra-G (98-06), Frontera-B (98-04), Omega-B, (98-03), Signum (03-05), Sintra (98-99), Vectra-B (97-02), Vectra-C (02-05), Zafira-A (99-05), Saab: 9-3 (98-04), 9-5 (02-06)
OEM TOOLS	Saab: 83 95 394(1), 83 95 337 (2), 83 95 352(3), 83 95 386(4)Vauxhall/Opel/ Saab: KM-927(2), KM-929(3), KM-932 (4), KM-933(1)
ENGINE CODES	Opel: X20DTH, X20DTL, Y20DTH, Y20DTL, X22DYH, Y22DTH, Y22DTR Saab: D223L

ENGINE TIMING TOOL SET FIAT / OPEL

53303 89,00€

GASOIL/DIESEL

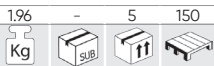

APPLICATIONS

FIAT: 1.9D / JTD (Motor Peugeot), 2.4D.
ALFA ROMEO: 145, 146, 156 JTD.
GM: GM 1.3, 1.6, 1.9, 2.0, 2.4 CDTI (2004 -).

OEM TOOLS

EN-46789 (1), EN-46789-100 (2),
EN-46785 (3), EN-46788 (4), EN-46781
(5), EN-46789 (6)

ENGINE CODES

GM: K1.3 CDTI | Z13DT Common Rail engine.
1.9 CDTi / 04-12 - Z19DT | Z19DTH | Z19DTJ | Z19DTL
2.0 CDTi / 08-12 - A20DT | LBS / LBX / LBY / LCDV
SAAB: 1.9 TiD.



ENGINE TIMING TOOL SET OPEL / VAUXHALL ASTRA, VECTRA, ZAFIRA 1.9CDTI

53302 44,00€

GASOIL/DIESEL

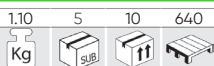

APPLICATIONS

SAAB: 9-3 (04-08), 9-5 (05-08).
VAUXHALL / OPEL: Astra-H, Vectra-C, Signum (04-07), Zafira-B (05-07).

OEM TOOLS

EN46789/32 025 008 (1) (3),
EN46788/32 025 009 (2), KM6349 (4)

ENGINE CODES

Z19DT, Z19DTH, Z19DTL.



ENGINE TIMING TOOL SET SAAB / OPEL / VAUXHALL

53305 136,00€

GASOLINA/PETROL



APPLICATIONS

VAUXHALL / OPEL: Antara (06-10), Calibra (93-98), Cavalier/Vectra-A (93-95), Omega-B (94-03), Signum (03-05), Sintra (96-99), Vectra-B (95-02), Vectra-C (02-05).
SAAB: 900 (93-98), 9000 (95-97), 9-5 (98-03)

OEM TOOLS

KM-800-1 (1), KM-800-2 (2), KM-800-20 (3), KM-800-10 (4), 83 95 006 (5), KM-800-30 (6), MKM-6038, 83 95 006 (7)

ENGINE CODES

2.5 V6: Saab; B2581, Vauxhall/ Opel; C25XE, X25XE.
2.6 V6: Vauxhall/ Opel; Y26SE.
3.0 V6: Saab; B308E, B308i, Vauxhall / Opel; X30XE.
3.2 V6: Vauxhall/ Opel; Y32SE.

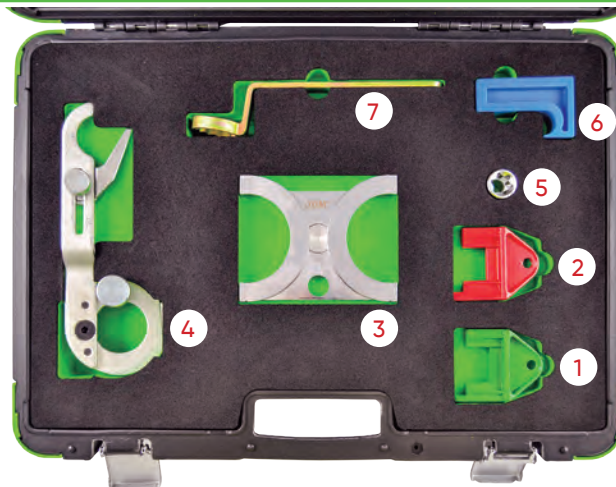

ENGINE TIMING TOOL SET FIAT

53304 279,00€

GASOLINA/PETROL



GASOIL/DIESEL

APPLICATIONS

FIAT

OEM TOOLS

1 860 874 000 (1), 1 860 895 000 (2), 1 860 898 000 (3), 1 860 905 000 (4), 1 860 845 000 (5)

ENGINE CODES

PETROL ENGINES: Fiat Brava , Bravo, Barchetta, Cargo, Coupe, Marela, Palio, Weekend, Punto, Multila, Stilo, Idea, Doblo Twin Cam Engines - 1.2, 1.4, 1.6, 1.8, 16V
DIESEL ENGINES: Fiat Brava, Bravo, Marela, Weekend, Palio, Punto, Multila, Doblo, Ulysse, Ducato, Stilo JTD Diesel Engines - 1.9D/TD . 1.9JTD . 2.4TD/JTD.

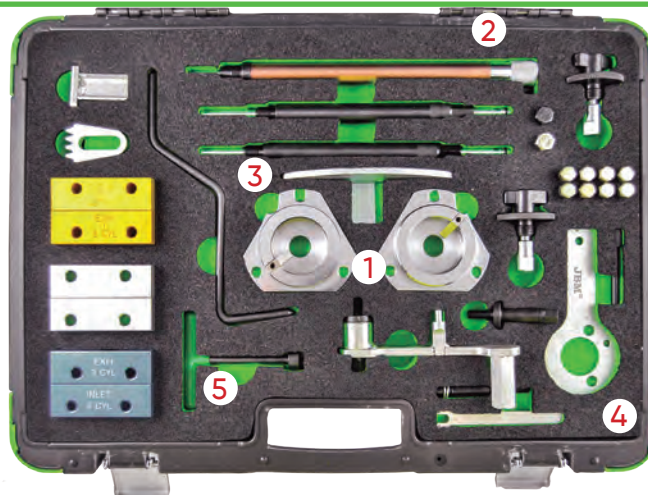

ENGINE TIMING TOOL SET ALFA / OPEL / VAUXHALL 1.6 / 1.8 16V

53307 38,50€

GASOLINA/PETROL

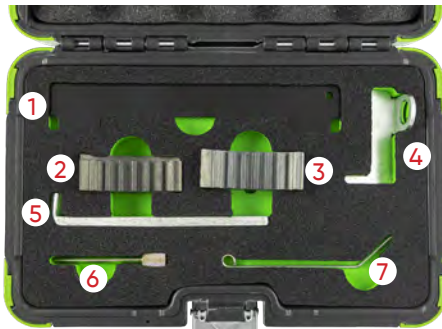
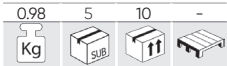

APPLICATIONS

OPEL / VAUXHALL: Corsa-D, Agila, Astra-G-H, Meriva, Zafira-B, Vectra-C, Signum, Insignia	1.6, 1.8
CHEVROLET: Aveo, Cruze, Orlando	1.4, 1.6, 1.8
ALFA ROMEO: 159 FIAT: Croma	1.8

OEM TOOLS

E10290 (1), 23056-06 (2) (3), E10230 (4), 23164-04 (5), 23174-01 (6), 23056-05 (7)

ENGINE CODES

OPEL / VAUXHALL: Z16LEL, Z16LER, Z16LET, Z16XE1, Z16XEP, Z16XER, A16XER, 18XER, A18XER, 2HO/A18XEL.
Chevrolet: G14D, LDD, LXV (F16D4), 2HO(Z18XER).
Alfa / Fiat: 939A4.000.

ENGINE TIMING TOOL SET FIAT / OPEL / VAUXHALL 2.2 16V CHAIN DRIVE

53316 34,00€

GASOLINA/PETROL

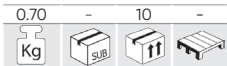

APPLICATIONS

OPEL: Astra-G (2000-2006), Astra-H (2006-2011), Signum (2003-2008), Vectra-B (2000-2002), Vectra-C (2002-2008), Zafira-A (2000-2005), Zafira-B (2005-2012), Speedster (2000-2006).
VAUXHALL: VX220 (2000-2006).
FIAT: Croma (2005-2009).

OEM TOOLS

VAUXHALL / OPEL: Z22SE, Z22YH
FIAT: 194A1.000.

ENGINE TIMING TOOL SET VAUXHALL/ OPEL 1.6 CDTI

54205 49,00€

GASOIL/DIESEL

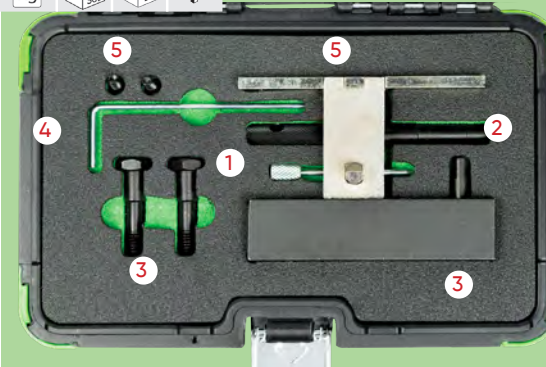

APPLICATIONS

Vauxhall/Opel: Astra J (13-18), Astra K, (15-19), GTC (15-18), Insignia A (15-17), Insignia- B (17-20), Meriva B (13-17), Mokka (14-16), Mokka X (16-20), Zafira C Tourer (13-19).

OEM TOOLS

EN-6349, EN-6130 (1), EN-51143 (2), EN-51140 (3), EN-50513 (4), EN-51188 (5)

ENGINE CODES

B16DTC, B16DTE, B16DTH, B16DTJ, B16DTL, B16DTN, B16DTR and B16DTU. D16DTH, D16DTI, D16DTJ, D16DTN, D16DTR, D16DTU

ENGINE TIMING TOOL SET 1.6D, 1.7D & ISUZU

54214 96,00€

GASOIL/DIESEL

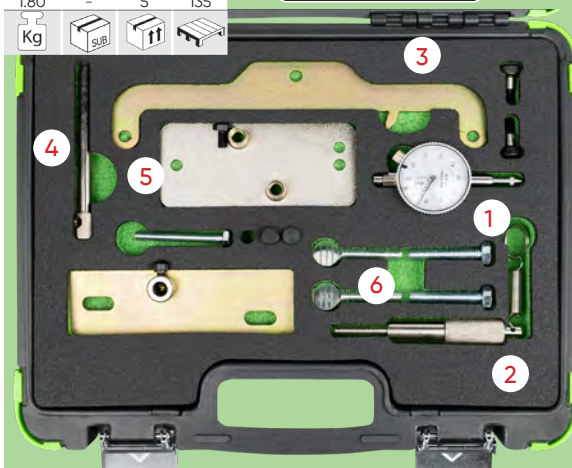

APPLICATIONS

ASTRA, CAVALIES, VECTRA-A(87-00), ISUZU, NOVA, CORSA / COMBO, STRA, CAVALIER, VECTRA, FRONTERA, MONTEREY, MIDI, BRAVA (88-04)

OEM TOOLS

VAS 6079 (1), KM 951 (2), KM 851 (3), 23-029 (4), KM 661-2 (5), KM 661 (6)

ENGINE CODES

OPEL : 16DA, 17D, 17DR, X17DTL
ISUZU : 4EC1, 4EE1, 4JB1, 4XJ1, 4JA1, 4JG1, 4FC1, 4FD1, 4FG1, Z17DT, Y17DT/DTL

ENGINE TIMING TOOL SET CITROËN / PEUGEOT

53313 139,00€

GASOLINA/PETROL

4,55	-	2	40
Kg	Sub	Box	Tray

GASOIL/DIESEL

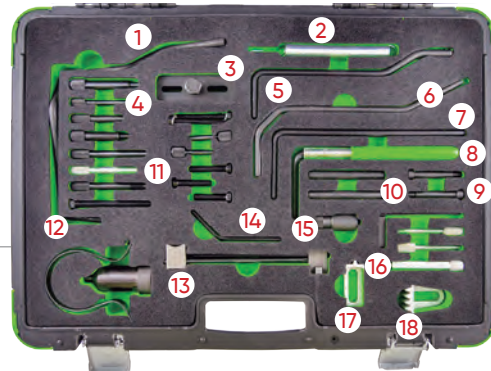

APPLICATIONS

CITROËN: AX, BX, Boxer, Berlingo, C25, Dispatch, Evasion, J5, Jumpy, Jumper, Relay, Saxo, Synergie, Visa, XM, Xsara, Xantia, XZ, ZX.
PEUGEOT: 106, 205, 206, 305, 306, 307, 309, 405, 406, 605, 607, 806, Expert, Partner, Solara, Talbot.

OEM TOOLS

7099TM (1), 0188X (2), 0188P (3), 0189AZ (4), 0188H (5), 0132AJ1 (6), 0189A (7), 0188PM (8), 21-260 (9), 4527-TS1 (10), M8X70 (11), 0188K (12), 0188J (13), 0132Q (14), 4507-TL (15), 4507-TJ (16), 9044-T (17), 4507-TJ (18), 5711-TA (19), 7014-TJ (20), 7017-TR (21), 0188X (22), 7017-TW (23), 7014-TM (24), 0189L (25)

ENGINE TIMING TOOL SET CITROËN / PEUGEOT 1.8 / 2.0

53314 98,00€

GASOLINA/PETROL

1,85	-	2	-
Kg	Sub	Box	Tray

APPLICATIONS

CITROËN: C4 Picasso/Grand Picasso (06-10), C5 II (04-08), C8 (05-10), Dispatch/Jumpy (07-11), Xsara 2.0 16v, C5 1.8/2.0/HPI, Xsara Picasso 1.8/2.0 16v (02-05)
PEUGEOT: 406 1.8 16v (00-04), 407 (06-10), 807 2.0 16v (02-05).

OEM TOOLS

0189S2 (1), 0188J (2), 0188J2 (2), 0189S1 (3), 21-260 (4), 0189B (5), 0188M (6), 0188AH (7), 0189R (8)

ENGINE CODES

1.8 16v: EW7A(6FY).
2.0 16v: EW10A(RFJ), EW10ABE4(RFH), EW10J4S (RFK).

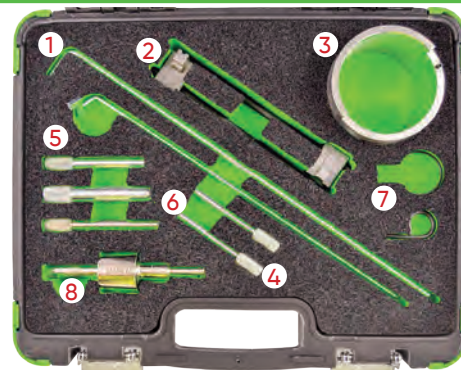

ENGINE TIMING TOOL SET RENAULT / NISSAN / OPEL / VAUXHALL 2.0 / 2.3 DCI / CDTI M9R / M9T

53311 97,00€

GASOIL/DIESEL

2,55	-	5	135
Kg	Sub	Box	Tray

APPLICATIONS

NISSAN: Primastar X83 (06-15), Qashqai/Qashqai+2 J10 (07-14), X-Trail T31 (07-14).
VAUXHALL/OPEL: Movano-B (10-17), Vivaro (06-15).
RENAULT: Espace/Grand Espace IV (06-10), Koleos (08-15), Laguna II (05-07), Laguna III (07-14), Master III (10-15), Megane II (06-10), Scenic/Grand Scenic II (06-09), Scenic/Grand Scenic III (09-15), Trafic II (06-14), Vel Satis (05-10)

OEM TOOLS

Mot1769 (1), EN-48334 (2), Mot1766 (3), EN-48330 (3), KM-6130 (4), EN-48332 (5), Mot1773 (6), EN-48831 (6)

ENGINE CODES

2.0D dCi M9R: 630, 780, 782, 784, 786, 788, 830, 832, 833, 834, 835, 836, 838, 855, 856.
2.0D CDTI M9R: 630, 780, 782, 784, 786.
2.3 Bi-CDTI: LP6/M9T706, LW7/M9T706.
2.3D dCi M9T: 670, 672, 676, 678, 680, 686, 690, 692, 694, 698.



CITROEN/PEUGEOT 1.0/1.2 VTI TIMING TOOL SET

53876 64,00€

GASOLINA/PETROL

1,80	-	5	120
Kg	Sub	Box	Tray

APPLICATIONS

CITROËN: C3 (III)
PEUGEOT: 208, 308, 2008 SUV (2012-2014)

OEM TOOLS

0109-2A (1),
0109-2B (2)

ENGINE CODES

1.0/1.2 VTI
EBO, (ZMZ), EB2, (HMZ)

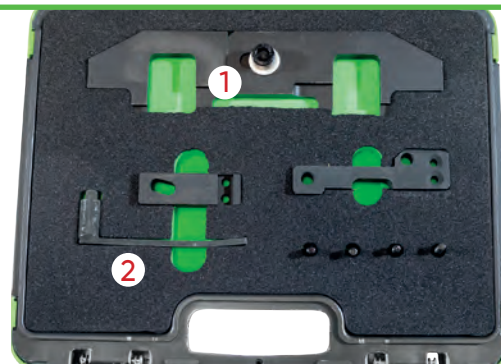

ENGINE TIMING TOOL SET FOR ROVER, PEUGEOT, FORD, VOLVO 2.0/ 2.2L D

54213 19,80€

GASOIL/DIESEL

0,40	6	24	240
Kg	Sub	Box	Tray

APPLICATIONS

Peugeot: 807 (05-11), 407 (05-11), 607 (05-09). Citroën: C4 (04-10), C5 II (04-10). Land Rover: Freelander (06-10). Volvo: S40 (03-10), V50 (06-10), C70 (06-10), S80 (07-10), C30 (06-10), V70 (07-10). Ford: S Max 2.2 (08-10), Galaxy 2.2 (08-10), Mondeo 2.2, 2.0 (07-10).

OEM TOOLS

PSA 0188.M, Ford 303-735, 303-1277, Volvo 999-7122 (1)
PSA 0188.X, Ford 303-1059, 303-1270, Volvo 999-7121 (2)
PSA 0188.F, Ford 303-393A, 303-393-01, 303-1272, Volvo 999-7119/7120 (3)

ENGINE CODES

PEUGEOT: DW10UTED4 (RHK), DW10BTED4 (RHR), DW12BTED4 (4HS), (4HP), (4HT), (4HR).
Citroën: DW10BTED4 (RHR). LAND ROVER: DW12BTED4, 224DT. Volvo: D420T 2.0D. FORD: QXBA(2.2), QXWA(2.0), QXBB(2.0), Q4BA(2.2), QXWA(2.0), QXWB(2.0), AZBA(2.0), AZBC(2.0), AZWA(2.0)



ENGINE TIMING TOOL SET **FIAT / ALFA / LANCIA**



APPLICATIONS	ALFA FIAT LANCIA	Alla, Barchetta, Bravo, Brava, Coupe, Delta, Dedra, Punto, Spider, GT
OEM TOOLS	1860845000 (1), 1822154000 (2), 1860905000 (3), 1860992000 (4), 1860895000 (5), 1860874000 (6), 1860985000 (7), KM571A (8), 1 860 896 000 (9), 0153A (10)	
ENGINE CODES	1.2 / 16V, 1.4 / 12V, 1.6 / 16V, 1.6 eco, 1.8, 2.0 / 16V, 2.0 / 20V, 2.4 / 20V, 3.0 / V6.	

ENGINE TIMING TOOL SET **FIAT/ALFA/LANCIA 1.2 16V, 1.4 16V, T-JET**



APPLICATIONS	Alfa Romeo: Giulietta (10-14), MiTo (08-17), Fiat: 500 (07-19), 500L (12-19), 500C (07-19), 500 Abarth (08-17), Bravo (07-14), Brava/Bravo (98-02), Doblo/Doblo Cargo (10-19), Egea (15-20), Grande Punto (07-10), Grande Punto Abarth (07-10), Idea (04-12), Linea (07-10), Marea/Weekend (98-00), Palio Weekend (01-06), Panda (07-11), Punto (97-08), Stilo (01-08), Tipo (15-20), Lancia: Delta (08-12), Musa (04-13), Ypsilon (96-11).	
OEM TOOLS	2.000.004.500 (1), 1.860.985.000 (2), 1.860.992.000 (3), 1.860.987.000 (4), 2.000.015.800 (5)	
ENGINE CODES	1.2 16v:176B9.000, 182B2.000, 188A5.000. 1.4 16v / T-Jet: 169A3.000, 192B2.000, 198A1.000, 198A4.000, 199A6.000, 198A8.000, 312A1.000, 312A3.000, 843A1.000, 955A1.000.	

ENGINE TIMING TOOL SET **FIAT / ALFA / FORD**



APPLICATIONS	FIAT: New 500 (07-09), Idea (04-09), Linea (07-09), Grande Punto (07-09), Doblo 1 Cargo (05-09), Panda EV02 (05) FORD: KA 1.2 Duratec (09) ALFA ROMEO	
OEM TOOLS	1 860 987 000 (1), 2 000 004 400 (2), 2 000 015 800 (3), 2 000 004 300 (4), 2 000 004 500 (5)	
ENGINE CODES	1.2: 169A4.000 / 199A4.000. 1.4: 350A 1.000 / 188A4.000-EV02.	

ENGINE TIMING TOOL SET FOR **ALFA ROMEO, LANCIA 1.75 TBI**



APPLICATIONS	Alfa Romeo: 159(09-12), Brera(09-11), Giulietta(10-19), Spider(09-11), 4C(13-19). Lancia: Delta(09-14).	
OEM TOOLS	2 000033500 (1), 2000 003000 (2), 1860898 000 (3).	
ENGINE CODES	Alfa Romeo 1,75 Tbi: 939B1.000, 940A1.000, 940B2.000, 960A1.000 Lancia 1,75 DI Turbo Jet: 939B1.000	

ENGINE TIMING TOOL SET FIAT 1.2 16V

53306 53,00€

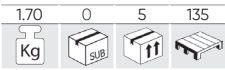

GASOLINA/PETROL

APPLICATIONS	FIAT: Fiat 1.2L 16V, Fiat Punto / Brava / Bravo / Stilo
OEM TOOLS	1860992000 (1) (2), 1871000900 (3), 1860987000 (4), 1869850000 (5)
ENGINE CODES	176 B9.000, 182 B2.000, 188 A5.000



ENGINE TIMING TOOL SET FIAT / IVECO 2.3 / 3.0 JTD

53319 18,00€

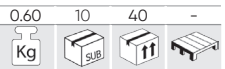

GASOIL/DIESEL

APPLICATIONS	FIAT: 2.3 / 3.0 JTD. IVECO: Daily.
OEM TOOLS	99360614, 1 860 617 000, 99360615, 2 000 018 200.
ENGINE CODES	F1AE0481C, F1AE0481D, F1AE0481N, F1CE0481A/D.

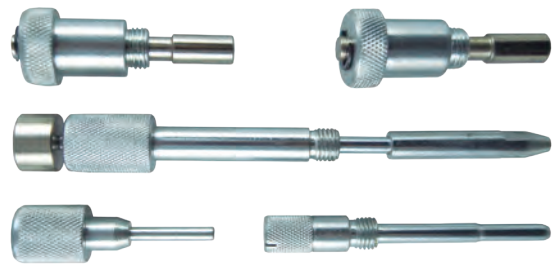

ENGINE TIMING TOOL SET ALFA / FIAT / LANCIA 1.4 / 1.6 / 1.8 / 2.0 16V

53309 285,00€

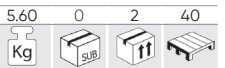

GASOLINA/PETROL

APPLICATIONS	ALFA ROMEO: 145,146,147,155,156, 1.4 1.6 1.8 2.0 TS, 1.4/1.6 16V; 145/146/147/155/156 (96-01), 1.8 16V; 145/146 (96-01), 155/156 (96-06), Spider/GTV (98-05), 2.0 16V; 145/146 (96-01), 147 (01-10), 155/156 (95-02), 166 (98-07), Spider/GTV (96-05), Purpur: 1.4, 1.6 // Blau: 1.8, 2.0 FIAT: Barchetta (96-00), Brava (95-00), Bravo (95-00), Coupe (96-01), Marea (96-00), Marea Weekend (96-00), Punto/Punto Classic (99-06), Stilo (01-08) LANCIA: Dedra (95-99), Delta (96-99), Kappa (98-02), Lybra (99-06).
OEM TOOLS	1.4 16v: 335.03 1.6 16v: 321.02, 321.03, 321.04, 372.03, 676.01 1.8 16v: 322.01, 322.05, 671.06, 182A2.000, 183A1.000, 183A6.000, 188A6.000, 192A4.000 2.0 16v: 162.01, 323.01, 323.1, 341.03, 363.01, 672.04 2.0 20v: 175A3.000, 182A1.000, 182B7.000, 185A8.000.



ENGINE TIMING TOOL SET FOR FIAT, LANCIA 1,4 12V

54212 39,40€

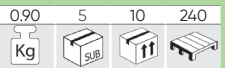

GASOLINA/PETROL

APPLICATIONS	Marea/Marea Weekend(96-20), Brava(95-98), Bravo(95-98), Lancia, Ypsilon(96-20)
OEM TOOLS	1860899000 (1), 1860901000 (2)
ENGINE CODES	1.4 12v : 182A3.000, 182A5.000.

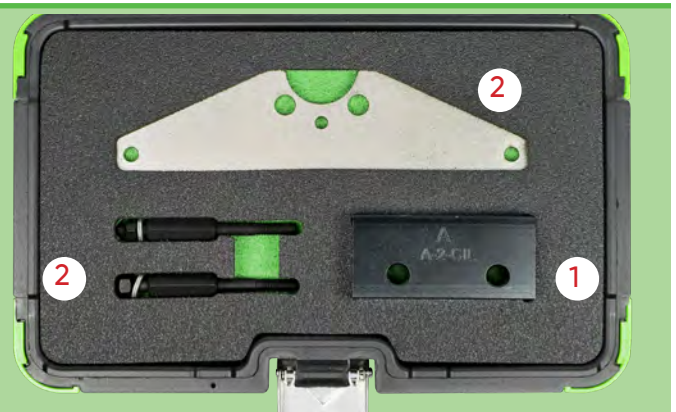

ENGINE TIMING TOOL SET ALFA ROMEO

53308

55,00€

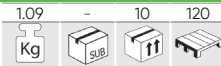

GASOLINA/PETROL

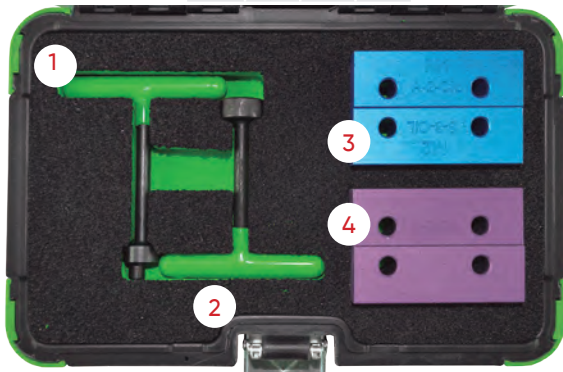

APPLICATIONS

ALFA ROMEO: 145,146,147,155,156, 1.4 1.6 1.8 2.0 TS, 1.4/1.6 16V; 145/146/147/155/156 (96-10), 1.8 16V; 145/146, (96-01), 155/156 (96-06), Spider/GTV (98-05), 2.0 16V; 145/146 (96-01), 147 (01-10), 155/156 (95-02), 166 (98-07), Spider/GTV (96-05), Pùrpura / Purple: 1.4, 1.6 // Azul / Blue: 1.8, 2.0

OEM TOOLS

1822149000 (1), 1822154000 (2), 1825041000 (3), 1825042000 (4)

ENGINE CODES

Z1.4/1.6-321.02, 321.03, 321.04, 335.03, 676.01
1.8/2.0-323.01, 672.04, 162.01, 323.10, 671.06, 322.01, 671.02, 322.05, 341.03, 363.01.

ENGINE TIMING TOOL SET ALFA ROMEO FIAT 1.4 MULTI AIR

54215

57,00€

GASOLINA/PETROL

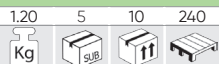

APPLICATIONS

Alfa Romeo Giulietta, Mito / Fiat Punto, Punto Evo 1.4 (Turbo) MultiAir (105/135/163/170PS)

OEM TOOLS

Alfa Romeo / Fiat: 1860987000 (1), 2000034400 (2), 2000004500 (3)

ENGINE CODES

940A2.000 / 940A2.000 / 955A8.000 / 955A8.000 / 940A2.000 / 955A8.000 / 955A2.000 / 955A7.000 / 955A6.000 / 955A8.000

FIAT / ALFA / LANCIA / OPEL / SUZUKI / FORD TIMING TOOL SET

53773

298,00€

GASOLINA/PETROL

GASOIL/DIESEL

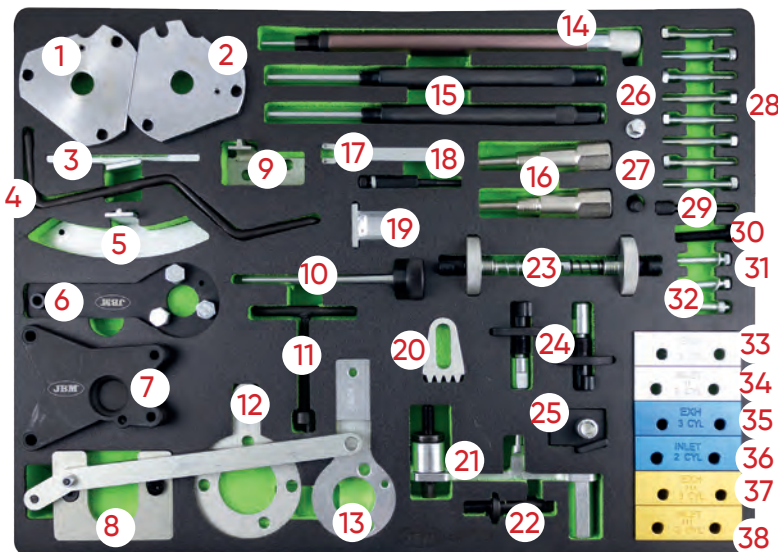

APPLICATIONS

ALFA: Romeo 145, 146, 147, 155, 156, 159, 166, Spider, GTV, TS, GT, Crosswagon Q4
FIAT: Punto, Grande Punto, Brava, Bravo, Marea, Weekend, Stilo, Doblo, Cargo, Idea, Panda, Multipla, Palio, Stilo, 500
LANCIA: Lybra, Ypsilon, Thesis, Musa
OPEL: Corsa, Agila, Meriva, Combo, Vectra, Zafira, Astra, Insignia, Signum 1.9 CDTI
SUZUKI: Ignis, Swift, Wagon R+
FORD: Ka

OEM TOOLS

1860874000 (1), 1860874000 (2), 20000004400 / 2190754400 (3), 1860863000 (4), 1860898000 (5), 2190754500 (6), 2000004300 (7), 1870900400 (8), 1860703000 (9), 1860933000 (10), 1860845000 (11), 1870900300 (12), 1860905000 / EN-46788 (13), 1895443000 (14), 1860992000 (15), 1870896900 (16), 1860987000 (17), 1860905000 (18), 1860771000 (19), 1860161000 (20), 1860876000 (21), 1860876000 (22), 1871000900 (23), 1860985000 (24), 20000004200 / 2190754200 (25), 1860965000 (29)

ENGINE CODES

176B9.000, 182B2.000, 188A5.000, 843A1.000, 323.02, 371.01, 182B4.000, 182B9.000, 186A6.000, 188A2.000, 188A7.000, 188B2.000, 192A1.000, 192A3.000, 937A2.000, 939A1.000, 192A5.000, 192B1.000, 198A5.000, 937A5.000, 939A2.000, 325.01, 342.02, 362.02, 185A6.000, 841C.000, 841G.000, 939A3.000, 940A3.000, 940A4.000, 940A5.000, Z19DT/DTH/DTR/DTJ/DTL, 169A1.000, 955A4.000, 350A3.000, 192B4.000, 198A2.000, 350A2.000, 955A3.000, 192A8.000, 198A6.000, 198A3.000, 199B1.000, 199B2.000, 199A2.000, 199A3.000, 199A9.000, 188A3.000, 188A8.000, 188A9.000, 192A9.000, 186A8.000, 186A9.000, 199A5.000, 223A7.000, 223A9.000, 841H.000, 841P.000, 185A2.000, Z13DT, Z13DTJ, Z13DTH, 182A4.000, 182A6.000, 182B6.000, 178B3.000, 186A3.000, 186A4.000, 350A1.000, 169A4.000, 188A4.000, 199A4.000, 199A7.000

FORD / SEAT / VOLKSWAGEN / MAZDA / VOLVO TIMING TOOL SET

53770 198,00€



GASOLINA / PETROL

GASOIL / DIESEL

APPLICATIONS

FORD: Fiesta, Fusion, Courier, Escort, Focus, Focus C Max, Puma, Mondeo, Sierra, Cougar, Galaxy, C-Max, Orion, Tourneo Connect, Transit, Transit Connect.
VW: Sharan.
SEAT: Alhambra.
MAZDA: 121.
VOLVO: S40, V50.

OEM TOOLS

303-1061 (1), 303-1054 (2), 23-059 / 310-085 (3), 21-105 (4), 323-029 (6), 0194-B / 21-263 / 303-735 / 49 JE 02 021 (7), 0132-AB / 0178-D / 21-151 (9), 0194-C, 21-262, 303-734, 49 JE 02 020 (10), 21-238 / 303-679A / 303-1151 (11), 21-238 / 303-679A / 303-1151 (12), 303-1054 (13), 303-1151 (14), 21-238 / 303-679A (15), 303-393 / 303-393-02 (16), 303-1097 (17), 21-168 / 303-393 (18), 303-0985 (20), 2064 / 23-047 / 310-055 / U20003 (21), 303-652 (22), 21-229, 303-651 (23), 303-748 (24), 21-210 (25), 21-260, 303-732 (26), 21-163, 303-620 (27), 21-234 / 21-251 (28), 303-675 / 303-698 (29), 21-104 / 303-193 (30) / 21-162B / 303-367 / 303-376 (31), 21-162B / 303-376 / 303-376B (32), 23-019 (33), 23-058 / 310-084 (34), 0153-M / 0178-C / 0178-D (35), 0178-B / 5711-TB (36), 21-123 (37), 23-020 (38), 21-234 / 21-251 (39), 303-1059 (40), 23-019 (41), 303-1060 (42), 303-393 / 303-393-01 (43)

ENGINE CODES

FUJA, FUJB, FXJA, FXJB, FXJBA, FYJA, FYJB, F8JA, F8JB, M7JA, M7JB, DHA, DHB, DHC, DHD, DHE, DHF, DHG, FHA, FHE, LIT, LIV, LIE, LIG, LIH, LIK, RDA, RDB, RKC, RQB, RQC, FXDA/C, FXDB/D, FYDA/C, FYDB/D, FYDH, HWDAIZ, AHU, AVG, AFN, D24, D24T, D24TIC, RFN, RTJ, RTK, RVA, RFK, RKD, B4164S3, DV4TD (8HV/8HX/8HZ), DV4TED4(8HV/8HY), DV6ATED4 (9HX/9HY/9HZ) F6JA, F6JB, F6JC, G8DA, G8DB, KKDA, SNJA, SNJB, STJA, STJB, ASDA, ASDB, FXJC, SPJA, SPJC, FYJC, HWDA, HWDB, SHDA, SHDB, SHDC, JQDA, LQDB, JTDA, JTDB, HXDA, HXJA, HXJB, IQDA/B, IQDB, PNBA, PNDA, RHBA, SIDA, F6JD, TZJA, TZJB, HHDA, HHDB, HHJA, HHJC, HHJD, HHJE, HHJF, RTA, RTB, RTC, RTD, RTG, RTE, RTF, RTH, RTJ, RTK, RFN, BHPA, HCPA, HCPB, KKDA, P7PA, P9PA, P9PB, R2PA, R3PA, RWPA, RWPC, F9DA/B, FFBA, FFWA, KHBA, QYBA, QYWA, KKDB, C9DC, RVA, IZ, AFN, AHU, ANU, AUY, G6DA, G6DB, G6DC, G6DD, G6DE, G6DF, G6DG, UFDB, TXDB, TYDA, UKDB, QXBA, AZBA, KLBA, QXBB, LPBA, AZBC, TYBA, UKBA, UFBA, TXBA, IXDA, QXWA, QXWB, AZWA, KLWA, AZWC, TYWA, UKWA, TXWA, UFWA, UFDA, TXDA, UKDA, Q4BA, KNBA, 4BA, 4BB, 4BC, 4CC, 4FA, 4CA, 4CB, 4DA, 4EA, 4FA, 4FB, 4FC, 4FD, 4GA, 4HB, 4HC, 4EB, 4EC, 4ED 4GA, 4GB, 4GC, 4GD, 4GE, 4GF, 4HA, 4HD, FMBA/B, D5BA, ABFA, D3FA, D6BA, HJBA/B, F3FA, D2FA, D4FA, F4FA, F5FA, DOFA, QJBA, QJBB, QJBC, QJBD, FXFA, H9FA, H9FB, N7BA, N7BB, MZ-CD 1.6, V6

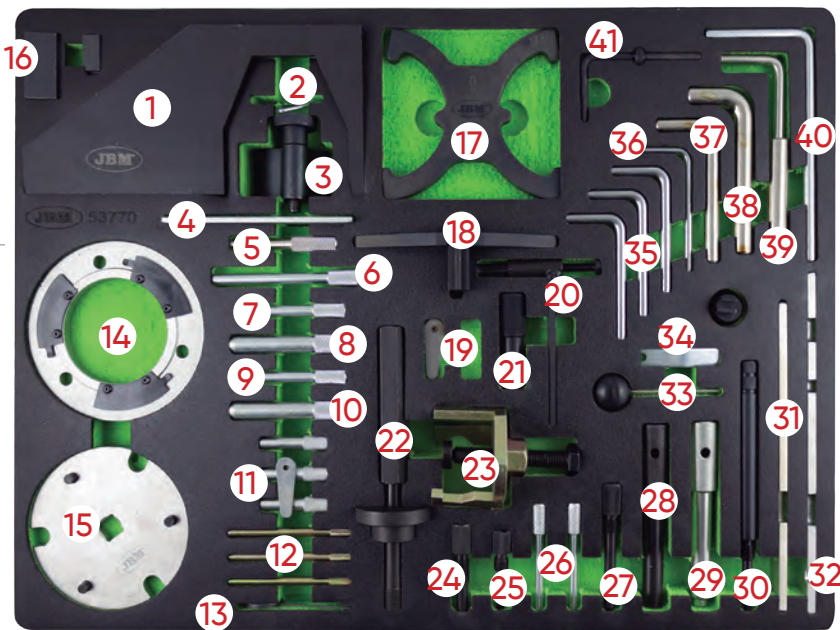

OPEL / CHEVROLET / SAAB / FIAT / LANCIA / SUZUKI / FORD TIMING TOOL SET

53774 190,00€

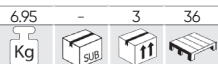

GASOLINA / PETROL

GASOIL / DIESEL

APPLICATIONS

ALFA: 145, 146, 147, 156, 159, 166, GT, Crosswagon Q4
FIAT: Punto, Grande Punto, Bravo, Brava, Marea Weekend, Stilo, Doblo, Cargo, Multipla Idea, Panda
LANCIA: Ypsilon, Musa, Lybra, Thesis
OPEL: Corsa B/C, Combo, Tigra, Agila, Tigra B, Meriva, Astra F/G/H, Astravan, Speedster VX220, Zafira A/B, Vectra B/C, Signum, Omega B, Sintra, Frontera A/B, Astravan, Kadett, Ascona, Omega, Monterey, Antara, Cromax, Speedster VX220
SUZUKI: Ignis, Swift, Wagon R+
FORD: Ka
CHEVROLET & DAEWOO: Epica, Captiva, Nubira, Lacetti, Evanda
SAAB: 9-3, 9-5 (98-04)

OEM TOOLS

1860905000 / 1860905010 / EN-46788 (1), KM-6148 (2), KM-6148 (3), 1870900400 / 1871000200 (4), KM-954 (5), KM-J-43651 (6), 1860905000 / 1860905010 / EN-46788 (7), KM-852 (8), KM-853 (9), 1870900300 / 303-1468 (10), EN-46785 / KM-951 (11), KM-932 (12), 1860703000 (13), KM-955 (14), KM-6130 / KM-6349 / KM-6349 (15), KM-927 (16), EN-48245 (17), KM-933 (18), EN-46785 (19), 1860985000 / 1871000900 / EN-46781 (20), 1860985000 / 1871000900 / EN-46781 (21), EN-48246 (22), KM-929 (23), 1870896900 / EN-46789 (24), KM-952 (25), 21-162B / 303-376 / 303-376B (26), KM-933 (27)

ENGINE CODES

X14XE, Z14XE, X16SEJ, X16XE, X16XEL, Y16XE, Z16XE, Z16YNG, C18XEL, X18XE, X18XE1, Z18XE, Z18XEL, C20SEL, C20XE, X20XEV, Z20LEH, Z20LEL, Z20LER, Z20LET, X22SE, X22XE, Y22SE, Y22XE, Z22XE, D223L, X10XE, Z10XE, Z10XEP, X12XE, Z12XE, Z14XEP, X20DTL, X20DTH, X22DTH, Y20DTL, Y20DTH, Y22DTH, Y22DTR, 169A1.000, 955A4.000, 350A3.000, 192B4.000, 198A2.000, 350A2.000, 955A3.000, 192A8.000, 198A6.000, 198A3.000, 199B1.000, 199B2.000, 199A2.000, 199A3.000, 199A9.000, 940A3.000, 188A3.000, 939A2.000, 188B2.000, 188A8.000, 188A9.000, 323.02, 371.01, 937A2.000, 182B4.000, 182B9.000, 188A2.000, 188A7.000, 192A9.000, 186A6.000, 186A8.000, 192A1.000, 192A3.000, 192B1.000, 192A5.000, 186A9.000, 939A1.000, 199A5.000, 223A7.000, 223A9.000, 342.02, 362.02, 841G.000, 841H.000, 841P.000, 939A3.000, 185A2.000, 185A6.000, Z13DT, Z13DTJ, Z13DTH, Z19DT, Z19DTH, Z19DTJ, Z19DTL, X10XE, Z10XE, Z10XEP, Z12XE, Z14XEP, X16SZR, Z16SE, 4EC1/T, 4EC1, 4EE1/T, 4EE1, X17DT, Y17DT, Y17DTI, Y17DTL, 16DA, 17D, 17DR/X, 7DTL, X17DTL, 4JX1/4, JG2T, 4FC1/T, 4FD1, X20DTL, Y20DTL, D223L Z20DMH, Z20DM, RA420, Z20S1, 194A1.000, Z22SE, Z22YH

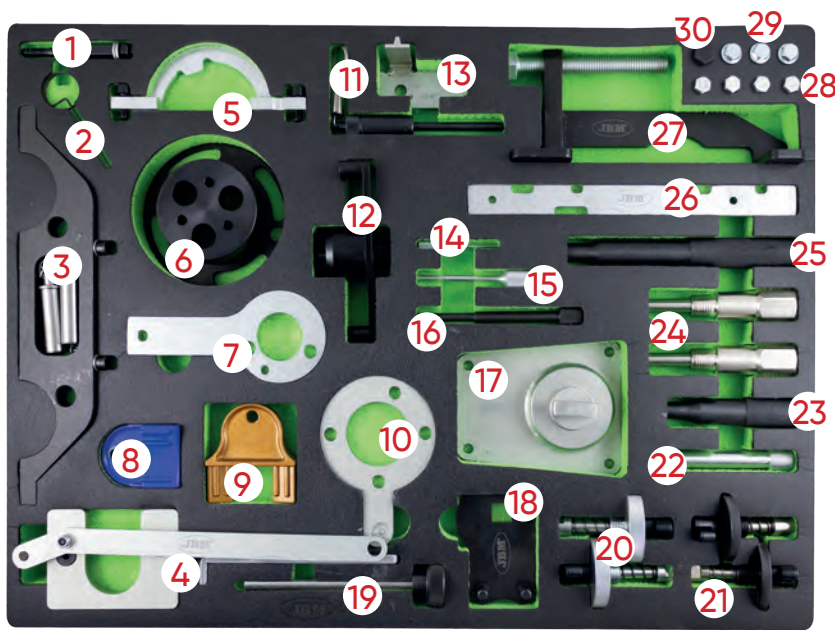

VARIOUS

FIAT / FORD / CITROËN / PEUGEOT TIMING TOOL SET

53771 158,00€

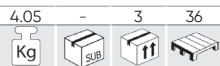

GASOLINA/PETROL

GASOIL/DIESEL

APPLICATIONS	<p>FIAT: Ulysse, Scudo, Ducato LANCIA: Zeta, Phedra FORD: Fiesta, Fusion, Focus, Focus C-Max CITROËN: C15, C1, C2, C3 Pluriel, C4, C4 Picasso, C5, C6, C8, DS3, DS4, DS5, Xantia, Xsara, Xsara Picasso, Evasion, Berlingo, Jumpy, Jumper, Saxo, ZX, XM, Evasion, AX PEUGEOT: 107, 107, 206 cc, 207, 208, 306, 307 cc, 308, 406, 407, 508, 607, 806, 807, Partner, Expert, Boxer, 206, 106, 605, 205, 405</p>
OEM TOOLS	<p>4200-TH (1), 0117-AR (2), 0188-X (3), 0606-A1A2 (4), 0188-Q2 (5), 0189-S1 (6), 7017-TR (7), 0132-P / 4507-TL (8), 0189-C (9), 0188-J1 (10), 0188-J2 (11), 0178-E (12), 0189-R (13), 0132-AK / 0188-AK / 0189-K / 0153-AK / 4533-TAD / MOT 1436 (14), 0188-AH (15), 0189-S2 (16), 0153-AB / 9041-TZ (17), 0153-M / 0178-C / 0178-D / 7014-TM / 9767-94 (18), 0189-A (19), 4527-TS1 (20), 0153-AB / 9041-TZ (21), 0189-B / 21-163 (22), 0132-AJ1 / 0153-G / 0188-M / 0189-J / 4533-TAC1 / 5711-TA (24), 0189-L (25), 0188-D / 7017-TM (26), 0132-X / 0188-Q1 / 4507-TJ / 9767-89 (27), 0194-B (28), 0132-AB / 0194-A (29), 0194-C / 21-262 / 303-734 (30), 4527-TS2 (31), 0188-E (32), 0153-A / 6012-T / 9765-54 (33), 0134-AF / 0134-Q / 0188-F / 9004-T (34), 0188-P2 / 0188-P / 174 / 7015-T (35), 0153-U 7019-T (36), 0153-N / 0188-Y / 7014-TJ / 7099-TM / 9797-34 (37)</p>

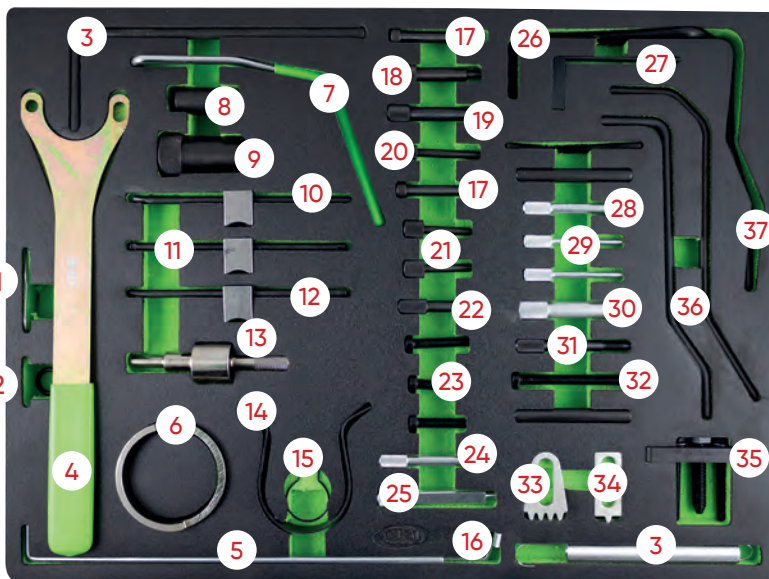

ENGINE CODES	<p>F6JA, F6JB, F6JC, G8DA, G8DB, HHDA, HHDB, HHJA, HHJB Citroen_Peugeot: 1.0 / 1.1 / 1.4 / 1.6 / 1.6 16V, 1.4 / 1.6HDI / 1.8 / 1.8 16V / 2.0 / 2.0 Turbo, 1.9D / 2.0HDI / 2.2HDI / 1.8 16V / 2.0 16V TU9 (CDY/CDZ), TU1 (HDY/HDZ/HFX/HFY/HFZ), TU3 (KDX/KDY/KDZ/KFX/KFZ), TU5JP4 (NFU/NFX), TU5 (BDY/BFZ/NFT/NFV/NFW/NFY/NFZ), XU7 (LFW/LFX/LFZ), EW7J4 (RLZ), XU7JP4 (LGY), XU10 (RFL/RFU/RFV/RFX/RGX/RGY), XU10JP4(RGX/RGY), EW10A (RFJ), EW10J4S (RFK), EW10D (RLZ), EW12J4 (3FZ), ET3JE (KFU), TU3A/JP (KFW/KFV), DV4TD (8HW/8HX/8HZ), DV4TED4 (8HV/8HY), DV6ATED4 (9HX/9HY/9HZ), EW10-CV1 (RLZ), EW12 (3FZ), DW8 (WJZ/WJY), DW10 (RHY/RHV/RHZ/RHS/RHM/RHW/RHT/RHR/RHX), DW12 (4HX/4HZ/4HW/4HY), EW7J4 (6FZ), EW10J4 (RFR), EW10J4D (RLZ), DW12TED4 (4HW), DW10ATED (RHT/RHV/RHW/RHX/RHZ) Ford 1.4 / 1.6 Duratorq TDCI</p>
---------------------	---

FORD / VAG / MAZDA / VOLVO TIMING TOOL SET

53772 229,00€

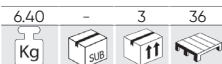

GASOLINA/PETROL

GASOIL/DIESEL

APPLICATIONS	<p>ALDI: 80, A1, A2, A3, S3, A4, A5, A6, TT, Q5 SEAT: Arosa, Ibiza, Cordoba, Leon, Toledo, Alhambra, Altea, Inca (99-04) SKODA: Fabia, Octavia, Superb VW: Lupo, Polo, Fox, Golf, Bora, Jetta, Golf Plus, Passat, Beetle, Touran, Sharan, Caddy, Caddy Maxi, Transporter, Golf VI Cabrio, Tiguan FORD: Galaxy</p>
OEM TOOLS	<p>T10252 (1), VAS6079 (2), T10121 (3), MPI-1312 / T10098 / T20038 / T20038 (4), T10123 (5), 23-058 / 310-084 / T10008 (6), 2065A / T10008 / U40021 (7), 3418 (8), T10171 (9), 23-059 / 23-059 / 310-085 / T10050 / T10050 (10), 3458 / T30094 (11), T10016 / T10074 / T10074 (12), T10100 (14), T10414 (15), 3366 / T20018 / T20044 (16), 3411 (17), 3369 / T30092 (18), T10341 (19), 3242 / T40069 / T30052 (20), T 40026 (21), 3359 / MPI-301 / T20102 (22), 2064 / U20003 (23), T10120 (24), MPI-1312 / T10098 / T20038 (25), T10170 (26), T00115 / T10264 / T40098 (27), T10092 (28), T00115 / T10264 / T40098 (29), 303-1054 / T10115 (30), T10060 / T10060A (31), 3359 / MPI-301 / T20102 (32), T10340 (33), 2587 (34), 3387 / U30009A (35), 3387 / T10020 (36)</p>

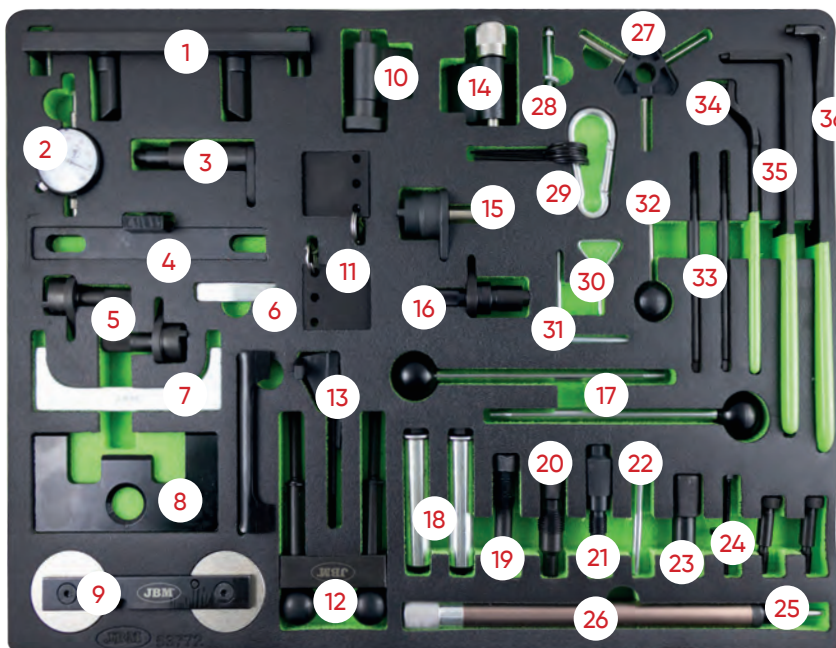

ENGINE CODES	<p>ARC, ATN, AUS, AVY, AZD, AFH, BCA, AJV, AKQ, AUA, AUB, AXP, AFH, AFN, AFK, AHW, AHU, APE, AQQ, AUS, AXP, AZD, BBY, BBZ, BCB, ANY, AYZ, AMF, ATL, BAY, BHC, BMS, BNM, BNV, BWB, AJM, AMG, ANU, ARL, ASZ, ATD, ATJ, AUY, AVB, AVF, AVQ, AWW, AXB, AXC, AXR, BEW, BJB, BKC, BKE, BLS, BLT, BMT, BPX, BRB, BRM, BRR, BRS, BRU, BSU, BSW, BTB, BUK, BVK, BXE, BFX, AZV, BDJ, BDK, BGW, BHW, BKD, BKP, BLB, BMA, BMM, BMN, BMP, BMR, BNA, BPW, BRC, BRE, BRF, BRT, BUZ, BE, BVF, BVH, BVK, BVS, BMY, BLF, BWV, AZV, BGD, AWY, AZQ (55 - 64 PF), AXU, BAG, BKG, BLF, BLN, BLP, BFV, BKF, BNU, BVP, BVR, IZ, CBZA, CBZC, CBZB, CAXA, CAGA, CAGB, CAGC, CAHA, CAYA, CAYB, CAYC, CBAA, CBAB, CBAC, CBBA, CBBB, CBDA, CBDB, CBDC, CBEA, CEGA, CKUB, AZV, BDJ, BHP, BKD, BLB, BMA, BMM, BMN, BMP, BMR, BNA, BPW, BRC, BRE, BRF, BRT, BSS, BUY, BUZ, BVA, BVE, BVF, BVG, BVH, BWV, ACV, ACV, AFB, AGX, AHD, AHY, AHY, AJT, AKE, ANJ, APA, AUF, AXG, AXG, AXL, AYC, AYM, AYY, BAW, BBE, BBF, BCZ, BDG, BDH, BFC, BJJ, BJK, BJL, BJM</p>
---------------------	--

ENGINE TIMING TOOL SET VOLVO 3.0 / 3.2T6 FREELANDER2 3.2I

53315 285,00€

GASOLINA/PETROL

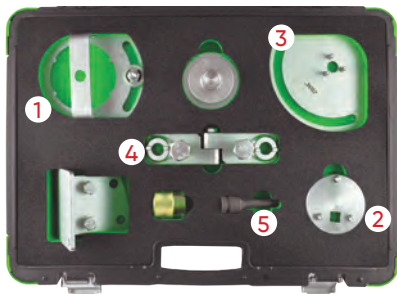
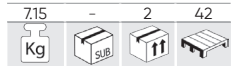

APPLICATIONS	VOLVO: S60 (10-16), S80 (07-15), XC60 (08-15), XC70 (06-15), XC90 (10-14), V60 (10-15), V70 (10-15). LAND ROVER: Freelander II (11-14).
OEM TOOLS	VOLVO: 999-7263 (3), 999-7264 (1), 999-7272 (5), 999-7257 (2), 999-7261 (4). LAND ROVER: 303-1225 (3), 303-1226 (1), 303-1219 (2), 303-1223 (4).
ENGINE CODES	3.0 Turbo: B6304T2, B6304T4. 3.2: B6324S, B6324S5. 3.2i6: B6324S.

PULLER SET FOR HIGH PRESSURE PUMP SPROCKET OR PULLEY FOR HYUNDAI AND KIA

54226 71,00€

GASOIL/DIESEL

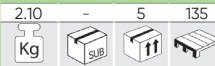

APPLICATIONS	HYUNDAI: Accent (11-15), Elantra (07-10), i20 (09-18), iX20 (10-18), i20 Coupe (15-17), i30 (07-19), iX35 (10-16), i40 (11-18). KIA: Carens (13-18), Ceed (07-18), Optima (11-15), Pro-Ceed (08-19), Rio (09-17), Cerato (05-07), Soul (09-14), Sportage (10-18), Venga (09-18).
OEM TOOLS	09331-2A000/2A010 (1), 09331-2A010 (1)
ENGINE CODES	1.1D CRDi: D3FF 1.4D CRDi: D4FC(U1), D4FC(U2) 1.6D CRDi: D4FB(U1), D4FB(U2), D4FB-H(U1), D4FB-H(U2), D4FB-L(U1) 1.7D CRDi: D4FD(U2), D4FD-H(U2), D4FD-L, D4FD-L(U2)

ENGINE TIMING TOOL SET FOR PORSCHE

54200 56,00€

GASOLINA/PETROL

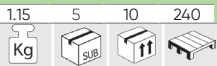

APPLICATIONS	911 (2001 - 2008), Boxster (2002 - 2011), Cayman (2006 - 2009)
OEM TOOLS	9685 (1), 9686 (2), 9595 (3), 9595/1 (4)
ENGINE CODES	M96/03, M96/05, M96/23, M96/25, M97/20, M96/24, M96/26, M97/01, M97/21, M97/22.



SET OF 6 TIMING TOOLS

53775 1.109,00€

GASOLINA/PETROL

GASOIL/DIESEL

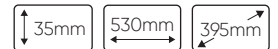
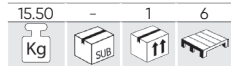

53769 RENAULT / NISSAN / OPEL / VOLVO



53770 FORD / SEAT / VOLKSWAGEN / MAZDA / VOLVO



53771 FIAT / FORD / CITROËN / PEUGEOT



53772 FORD / VAG / MAZDA / VOLVO



53773 FIAT / ALFA / LANCIA / OPEL / SUZUKI / FORD



53774 OPEL / CHEVROLET / SAAB / FIAT / LANCIA / SUZUKI / FORD



7 DRAWER CABINET WITH TIMING TOOLS SET

53951 1.794,00€

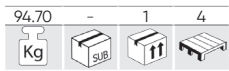

53952 1.794,00€

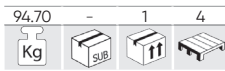

53775 1.109,00€

GASOLINA / PETROL

GASOIL / DIESEL

SET OF 6 TIMING TOOLS

53772



53773



53774



53769



53770



53771



UNIVERSAL PULLEY & FAN CLUTCH HOLDER SET

51340 39,30€

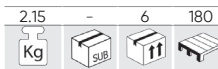

- Contents:

1 Spanner: Opening range: 40mm min - 235mm max. + Length 540mm.
4 sets of 2 adapter screws with 4 measurements.
1 set of 2 threads with 1 cm diameter.



CAMSHAFT SPROCKET PULLER FOR FORD

53318 24,00€

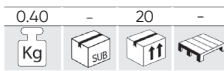

APPLICATIONS FORD

APPLICABLE TO F8M, F8Q, S8U, S9U.

ENGINE TIMING TOOL SET FOR RENAULT, NISSAN, DACIA, SUZUKI

51488 16,00€

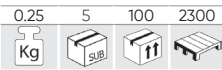

- Camshaft and crankshaft unit safety catches for Renault diesel and gasoline engines.
- Convenient for locking engine during change or maintenance of camshaft assembly.

APPLICATIONS

RENAULT: Captur, Clio II,III,IV, Espace/Grand Espace III,IV, Fluence, Kadjar, Kangoo, Laguna I,II,III, Logan/Logan MCV, Megane I,II,III,IV, Modus/Grand Modus, Scenic/Grand Scenic I,II,III,IV, Twing II, Trafic II, Master II 1.5dCi & 1.9 dCi.
DACIA: Dokker, Duster, Lodgy, Logan, Sandero 1.5dCi
NISSAN: Almera, Cube, Juke, Kubistar, Micra, Note, NV200/Evalia, Primera, Tiida, Interstar, Primastar 1.5dCi & 1.9 dCi
SUZUKI: Grand Vitara, Jimny 1.5DDiS & 1.9DDiS

OEM TOOLS

MOT1489, MOT1430, MOT1054.

ENGINE CODES

K9K, F8Q, F9Q - Petrol, Clio, R19, Laguna 1.8/2.0 F3R F3P



TIMING TOOLS VAG

52271 18,00€



APPLICATIONS

AUDI: A2 1.4TDI (02-06), A3 1.9 2.0TDI (02-08), A4 1.6TDI (02-05), A4 1.9 2.0TDI (04-08), A6 1.9TDI (02-05).
SEAT: Altea 1.9SDI/TDI (05-08), Leon 1.9 2.0TDI (05-08), Toledo 1.9SDI/TDI (05-08).
SKODA: Fabia 1.4TDI (03-06), Octavia II 2.0TDI (03-06)
VW: Beetle 1.9TDI (02-08), Bora 1.9TDI (02-08), Fox 1.4TDI (02-08), Golf 1.9 2.0TDI (02-08), Lupo 1.4TDI (02-08), Polo 1.4, 1.9TDI (02-08), Sharan 1.9TDI (02-08).

ENGINE CODES

AUDI: AMF, ASZ, ATD, AVB, AVF, AWX, AXR, AZV, BHC, BKC, BKD, BKE, BLB, BMN, BNA, BPW, BRB, BR, BRD, BRE, BRF, BUY, BVA, BVF, BVG.
SEAT: BJB, BKC, BLS, BMM, BXE
SKODA: AMF, AZV, BKD
VW: AJM, AMF, ANU, ARL, ASZ, ATD, AUJ, AVB, AVF, AWX, AXR, BAY, BMS, BNM, BNV, BWB

PETROL ENGINE CAMSHAFT SETTING TOOL

51489 12,00€



GASOLINA / PETROL

- Easy to use to lock camshaft pulleys when maintenance is performed.

APPLICATIONS

VW: Lupo 99, Polo 95, Caddy 96, Polo Classic, Variant 96, Beetle 1.4L 99, Golf 1.4L, 1.6L 98 y 1.4L, Bora, 1.6L 99.
AUDI: A2.

OEM TOOLS

T10016.

ENGINE CODES

1.4 / 1.6 16V



LOCKING TOOL SET FOR VAG

53320 12,00€

GASOIL / DIESEL

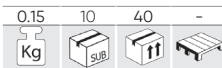

APPLICATIONS

SEAT: Alhambra, Altea, Arosa, Cordoba, Ibiza, Leon, Toledo 1.4/1.9/2.0 TDI.
VW: Passat 1.9.
AUDI: A4/A6 1.9.

OEM TOOLS

T10008, T20102, T10100.



VAT not included

JBM / www.jbmcamp.com

245

VARIOUS

CRANKSHAFT REAR SEAL INSTALLATION TOOL (VAG GROUP)

53875 134,00€

1.85	-	4	168



APPLICATIONS

VW: Golf, Touran
AUDI: A3, A4

OEM TOOLS

OEM T10134.

ENGINE CODES

1.4i turbo
1.4 & 1.6 Petrol Direct Injection
1.9/2.0 SDI
2.0 Common Rail Diesel engines

AUXILIARY STRETCH BELT REMOVAL/INSTALLATION TOOL

51927 25,00€

0.65	-	5	640



- To assemble-disassemble and remove new POLY-V belts easily.
- Suitable for PSA and Ford Fiesta 1.4/1.6, Citroën C4, Peugeot 307, Fiat Doblo, Dacia Logan engine.
- Essential tool for professional use.
- Without a precise gripping point, the belts appropriate for this equipment can not be disassembled and removed.

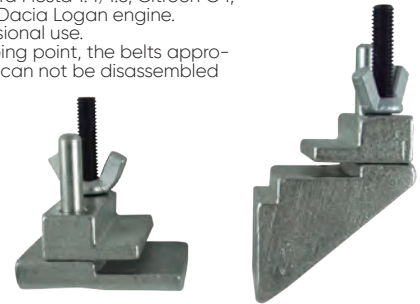

CAMBELT TENSIONER GAUGE

52616 44,00€

0.35	10	40	800

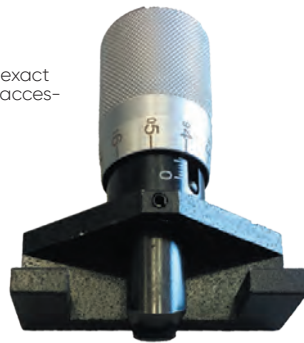

- Cam belt tension gauge provides an exact tension measurement on any timing or accessory belt, on any vehicle.

TENSIONER PULLEY WRENCH FOR VW AUDI 2.5 TDI 35MM

53325 7,50€

0.10	20	100	-

GASOLINA/PETROL



APPLICATIONS

AUDI: 100 ('91-), A6 (2.5 TDI) 2.3, 2.4, 2.5, 2.8, 2.9D TDI (1991-2003)
VW: LT, Transporter

OEM TOOLS

3355

ENGINE CODES

AAB, AAT, ACU, ACV, AEL, AET, AGX, AHG, AHY, AJA, AJT, ANJ, APA, APL, AUF, AVT, AXG, AXL, AYC.

TENSIONER WRENCH FOR VAG

53321 10,50€

0.25	10	50	-

GASOLINA/PETROL

APPLICATIONS

AUDI: A4/1.8T, 2.0 1999-2004 A6/1.8T 2002-2004 A4/3.0 (2002 -), A6/3.0 (2002 -), A8/7.0 (2003 -).
VW: Golf Passat 2.0 TDI DIESEL, Golf 88-97, Passat 92-97, VW T4/2.0 1992-2004.

OEM TOOLS

T10020.



WATER PUMP SPROCKET RETAINER HOLDING TOOL FOR OPEL VAUXHALL 2,2

53317 34,00€

0.64	-	12	-

GASOIL/DIESEL



- Used to keep the engine in the timed position during removal / installation of the coolant pump.
- Allows the pump to be replaced without the timing chain being disturbed.

APPLICATIONS

OPEL 2.2 Chain
VAUXHALL 2.2 Chain



1/2" SPINDLE NUT SOCKET FOR MERCEDES

52819 22,00€

0.24	15	60	-

1/2" MERCEDES



58 POINTS





LUBRICANT AND ACCESSORIES

- 248 OIL COLLECTOR SPILL PALLETS
- 250 DIESEL FUEL PUMP
- 251 UREA PUMP
- 252 OIL PUMPS
- 253 OIL DRAINER / OIL FILLER PUMPS
- 256 SUCTION GUNS
- 258 OTHERS

DRUMBANK SPILL PALLET

Removable cover / Fixed pallet for spill / Remove drums before using the forklift / Easy transportation / It can be used with most forklifts and palletizers / Made of polyethylene (PE) 100% recyclable.

SUPPORTS 400 KG

52804 343,00€

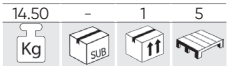

230L



1 VERTICAL DRUM

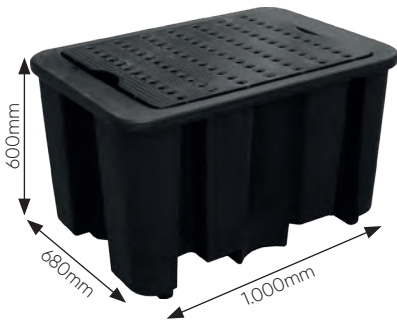

SUPPORTS 650 KG

52805 426,00€

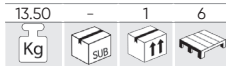

250L



2 VERTICAL DRUMS



NOT SUITABLE FOR PALLETS
SUPPORTS 1250 KG

52806 742,00€

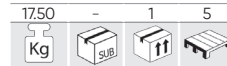

250L



4 VERTICAL DRUMS



DRUM OIL COLLECTOR SPILL PALLET SPECIAL FOR EUROPALLET

53214 285,00€

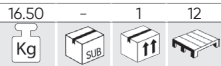

- For 2 drums.
- Fits Euro pallets (1200 mm x 800 mm) and plastic pallets of a similar size.
- Stackable for economic transport/storage.
- Place an Euro pallet directly into the sump to save cost.
- Loaded pallets can be placed onto/lifted from sump or platform by forklift.
- Low sump for ideal working height.
- Capacity meets/exceeds European, UK and US regulations.
- Forkliftable from 4 sides and pallet-truckable from 2 sides, whilst empty.
- Made from PE-100% recyclable.

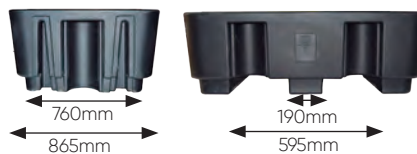

IBC OIL COLLECTOR SPILL PALLET 1.000L

52807 1.714,00€

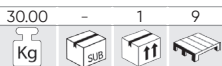

SUPPORTS 2.500 KG

- Stackable, space saving, innovative.
- Low height (700mm) to facilitate its use.
- Wide work surface (2,5 m²).
- Hands grip platform and inspection holes.
- Easy transportation. It can be used with most forklifts and palletizers.
- Made of polyethylene (PE) 100% recyclable.



HOMOLOGATED DIBT

JERRY CAN

54181 25,10€

1.45	-	4	72
Kg	sub	ff	ff

5L

55x26x35cm

54182 34,70€

2.55	-	4	48
Kg	sub	ff	ff

10L

57x35x42.5cm

54184 44,00€

4.10	-	4	24
Kg	sub	ff	ff

20L

76x37x50cm



54183 38,20€

2.75	1	6	48
Kg	sub	ff	ff

54x39x58cm

UN

S

10L

ANTI-OVERTURN



FLEXIBLE FILLING HOSE FOR JERRY CAN
(REF.54181, 54182, 54183, 54184)

15874

6,50€

0.30	50	800
Kg	sub	ff

STEEL DRUM TROLLEY

50924 342,00€

31.00	-	1	6
Kg	sub	ff	ff

- Suitable for 200L steel oil drums.



ROTATING WHEEL

DRUM CLAMP (CAPACITY 500 KG.)

53612 96,00€

4.75	-	1	66
Kg	sub	ff	ff

500Kg

- For easy oil drums handle.
- Max load: 500kg.
- Vertical type of drum grip.
- Special 200L oil drums.



CE

NYLON DRUM WRENCH

52452 8,00€

0.12	6	60	1080
Kg	sub	ff	ff

- Material: Nylon.
- Anti-spark and anti-dust.
- Sizes 3/4" and 2".
- Useful for 200L.



TAP FOR 200L DRUM

53078 18,00€

0.25	5	25	300
Kg	sub	ff	ff

- Allows a fast draining of 200L barrels.
- It can be used for water, all kind of oil, alcohol and ketone, as well as weak acid and weak base liquid.

- Material: PE.
- EPDM gasket.
- Stainless steel spring.



3/4" PLASTIC BARREL TAP

53518 3,50€

0.05	10	500	3000
Kg	sub	ff	ff

- Suits all type of liquid.
- 3/4" male thread.

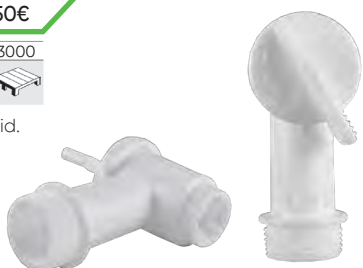

200L

3/4" AUTO-RELEASE LOCKABLE BARREL TAP

52453 21,00€

0.19	5	100	1000
Kg	sub	ff	ff

- Security Brass.
- Sizes 3/4".
- Body alignment.
- Nylon.
- Applications: oil, lubricants, gasoline, diesel, kerosene, etc.
- Valid for Urea AUS32.



200L

DIESEL FUEL PUMP WITH GUN AND COUNTER (200V-240V)

53697 398,00€

17,00	-	1	18
Kg	sub	ft	ft

- Rated Voltage: 220V±10% 50HZ.
- Rated Power: 550W.
- Max. Flow: 20-65l/min.
- Cable length: 2m.
- Suction hose length: 2m.
- Supply hose length: 4m.



200V	550W	50Hz
240V		
2m	4m	20-65l/min



PUMP FOR DIESEL SUPPLY

15981	8.75	-	2
181,00€	Kg	sub	ft



GUN FOR DIESEL SUPPLY

15980	1.20	20
55,00€	Kg	ft



COUNTER DIESEL/ PETROL

15982	1.85	8
73,00€	Kg	ft



HOSE FOR SUPPLY

15984	0.60	-
48,00€	Kg	ft



HOSE FOR EXTRACTION

15983	0.60	10
11,50€	Kg	ft

DIESEL PUMP WITH NOOZLE

- Portable fuel transfer pump.
- Easy to carry: compact size and carry handle integrated.
- Noozles with automatic stop.



DIESEL TRANSFER PUMP WITH DISPENSING NOOZLE (230V)

53610 294,00€

13,00	-	1	24
Kg	sub	ft	ft

WITH AUTOMATIC STOP

- Electric pump.
- Hoses and gun supplied.



230V	10A	2800 RPM	60L/min
550W			
2m	4m	Altura máxima de aspiración	5m
		Maximum suction height	

PUMP

15981	8.75	2
181,00€	Kg	ft

GUN

15980	1.20	20
55,00€	Kg	ft

HOSE FOR EXTRACTION

15983	0.60	10
11,50€	Kg	ft

HOSE FOR SUPPLY

15984	0.60	-
48,00€	Kg	ft

DIESEL TRANSFER PUMP WITH DISPENSING NOOZLE (12V)

53609 190,00€

7,30	-	1	24
Kg	sub	ft	ft

WITH AUTOMATIC STOP

- Inlet hose length: 2m.
- Length of the outlet hose: 4m.



12V	10A	3600 RPM	45L/min
175W			
2m	4m	Altura máxima de aspiración	3m
		Maximum suction height	

PUMP

15553	3.35	1
108,00€	Kg	ft

GUN

15980	1.20	20
55,00€	Kg	ft

HOSE FOR EXTRACTION

15983	0.60	10
11,50€	Kg	ft

HOSE FOR SUPPLY

15984	0.60	-
48,00€	Kg	ft

DIESEL ELECTRIC PUMP

54100 265,00€

4,00	-	4	24
Kg	Sub	11	11

Flow of up to 18.4 liters per minute.
Flow: 18.4LPM (4.86GPM)
Suction tube length: 850-1245mm
Hose length: 2m
Working temperature:
5° - 40°C (41° to 104°F)
DC Voltage: 12V
Alternating current: 100-240V
Cable length: 4m



12V	100V 240V	50-60Hz	18,4 L/min
200L	2m	2 bar	30 PSI



AUTOMATIC GUN FOR UREA AUS32 SUPPLY (REF.53645)

15631 98,00€

1,15	-	10	-
Kg	Sub	11	11

6 bar



UREA AUS32 PUMP (75L)

53644 1.238,00€

18,15	-	1	4
Kg	Sub	11	11

- A free standing and fully mobile 75L with a 12V powered pump (capable of delivering up to 10lit/min), hose and auto shutoff valve.
- Made of polyethylene which is impact, corrosion and UV resistant.
- The large diameter wheels (200mm) allow it to be easily moved over workshop.

1,040mm	440mm	520mm
---------	-------	-------

12V	75L	10 L/min
40 PSI	2,75 bar	4m



75L



ELECTRIC PUMP FOR UREA AUS32

53645 268,00€

3,10	-	4	24
Kg	Sub	11	11

- Electric pump designed for water based media, Urea AUS32 DEF & select chemicals from metal drums of 205L or 1000-1250L IBC'S.
- Compact & lightweight construction.
- Built-in fuse for overload protection and silent motor.
- Stainless Steel filter built into the suction tube inlet preventing contaminants from getting in and causing damage.



ON/OFF SWITCH WITH LED INDICATOR

850-1246mm

TELESCOPIC SUCTION TUBE EXTENDS FROM 33-1/2" (850MM) TO 49" (1245MM)



4M HOSE	15123	10
	32,00€	11

4M HOSE	14473	5
	46,00€	11

IBC TANK INLET ADAPTER

14703	50
13,00€	11

30mm
187mm
187mm
2" BSP



12V	100V 240V	50-60Hz	18,4 L/min
200L	2m	2 bar	30 PSI



VAT not included

JBM / www.jbmcamp.com

AIR-OPERATED OIL PUMP KIT+ HOSE WITH DISPENSING GUN

52601 397,00€

9,10	-	2	34
Kg	Sub	ff	ff

200L

- Ratio Pressure: 5: 1.
- Air inlet: 1/4".
- Air outlet: 1/4".
- Working Pressure: 6-8 bar.
- Max. Pressure: 8 bar.
- Air consumption: 250 L/min.
- Relative capacity at 6 bar: 18 L/min.
- Oil temperature range: -10-50 °C.
- Maximum viscosity: 240 SAE.
- Tube length: 950 mm.



HOSE WITH TAP FOR REF. 52601

12056	1,71	-
57,00€	Kg	ff

AIR-OPERATED OIL PUMP KIT + DIGITAL HOSE END METER

50935 595,00€

10,70	-	1	20
Kg	Sub	ff	ff

200L

- Air consumption: 250 L/min.
- Relative capacity at 6 bar: 18 L/min.
- Air outlet: 1/2".
- Oil temperature range: -10-50 °C.
- Maximum viscosity: 240 SAE.
- Ratio Pressure: 5: 1.
- Air inlet: 1/4".
- Air outlet: 1/2".
- Working pressure: 6-8 bar.
- Max. pressure: 8 bar.
- Hose length: 2 m.
- Tube length: 950 mm.



AIR-OPERATED OIL PUMP

50918 341,00€

7,25	-	2	34
Kg	Sub	ff	ff

200L

- Ratio Pressure: 5: 1.
- Air inlet: 1/4".
- Air outlet: 1/2".
- Working pressure: 6-8 bar.
- Max. pressure: 8 bar.
- Air consumption: 250 L/min.
- Relative capacity at 6 bar: 18 L/min.
- Oil temperature range: -10-50 °C.
- Maximum viscosity: 240 SAE.
- Tube length: 950 mm.

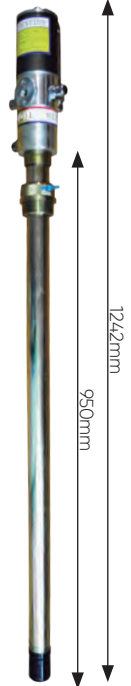

STEEL DRUM NUT FOR REF. 50935 AND 50918

10767	0,28	90
21,00€	Kg	ff

10925	0,67	90
18,00€	Kg	ff

DIGITAL HOSE END OIL METER WITH PIPE

50917 271,00€

2,15	-	10	80
Kg	Sub	ff	ff

REPLACEMENT BATTERIE FOR 50917

10000	2,10	-	10
7,00€	Kg	Sub	ff



- Air inlet 1/2".
- Volume range: 1-35 L/min.
- Working pressure: 6 - 8 bar.
- Oil temperature range: -10~60°C.
- Maximum viscosity: 240 SAE.
- Battery included.
- Weight: 1,4Kg.

LEVER PUMP THREAD ADAPTER

13982 4,00€

0,05	-	100	-
Kg	Sub	ff	ff

- Allows to adjust and compensate the different threads of drums, barrels and pumps.



ROTARY PUMP

52428 43,00€

1,40	-	10	120
Kg	Sub	ff	ff



- Drum 50 and 200L.
- Vol. 400ml.
- Capacity pump: 32L x 60 seconds.
- Adaptor 2" included.
- Suction pipe 101cm with entrance 1 1/4" exit 1".
- Not allowed for: strong acid, bleaches, gasoline.
- Applications: oils, lubricants, diesel, oil-based fluids.
- Recommended for: antifreeze, brake fluid, detergents, glycerine, mild acids, oil-based fluids.
- Not allowed for: strong acid, bleaches, gasoline.

LEVER PUMP

51253 41,00€

2,06	-	10	180
Kg	Sub	ff	ff

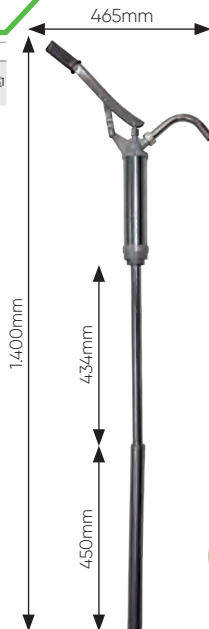

PLASTIC LEVER PUMP

52329 36,40€

0,98	-	10	150
Kg	Sub	ff	ff

- Drum 25, 50, 200L.
- 350ml pump.
- Body and piston of polypropylene.
- Handle plastic ABS.
- Applications: Alcohol, oil, lubricants, gasoline, diesel, kerosene, etc.
- Suction line: Minimum width: 320mm. Maximum length: 900mm.



90L MOBILE WASTE OIL DRAINER WITH INSPECTION CHAMBER

53874 398,00€

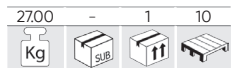

90L **8-10 BAR**

SPARE PARTS AVAILABLE



Designed to collect and drain engine oil and gear oil from vehicles.

- Air working pressure 8 bar
- Vacuum pressure: negative 0 ~ 0.8 bar
- Tank capacity: 70L
- Collection funnel capacity: 10L
- Measuring glass capacity: 10L
- Oil suction flow rate according to dipstick probe diameter: 0.8L/min (Ø5x3.5mm); 1L/min (Ø6x4.5mm); 1.6 L/min (Ø8x6.5mm)
- Dimensions: 43x49x163cm
- Medium: Engine oil and gear oil
- Recommended working oil temperature: 40 ~ 60°C
- Ocular measurement system.
- Big capacity tank.
- Handle to facilitate manipulation.
- Wheels to facilitate the transport.

REF.	CARACTERÍSTICAS	Kg	Sub	U	U	€
15018	Eva tray oil drain plug socket set of 22pcs	1,45	-	10	480	46,00€
14937	Wheel for oil collector 80l	0,30	-	14	-	9,50€
15282	Pressure gauge	0,20	-	20	-	15,00€
15283	Hose	0,40	-	20	-	27,50€
15305	Hose with hook tap	0,65	-	40	-	19,50€
15306	Hose to connect the funnel to the diposit with shut-off valve	0,35	-	20	-	27,50€
15307	Funnel	2,10	-	10	40	39,60€
15310	Tap upper part	0,05	-	20	-	11,50€
15311	Set of fittings	0,20	-	20	-	11,50€
15312	Fitting for connecting the diposit and the hose	0,10	5	40	-	11,50€
15318	Conection tube	0,80	-	20	-	17,00€
15308	Small swiveling wheel	0,35	-	40	-	7,00€
14014	4mm replacement hose	0,02	-	150	1500	6,00€
14015	6mm replacement hose	0,05	-	150	2250	6,00€
14016	8mm replacement hose	0,05	-	100	-	6,00€
15550	Metal suction tube 6mm	0,05	-	100	-	6,00€
15551	Metal suction tube 8mm	0,05	-	100	-	6,00€



EVA TRAY OIL DRAIN PLUG SOCKET SET OF 22PCS

15018 46,00€

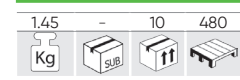

MOBILE OIL DRAINER WITH TANK

53873 285,00€

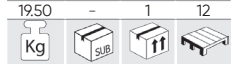

80L **1-3 BAR**

Designed to collect and drain engine oil and gear oil from vehicles.

- Air working pressure 6 bar
- Tank capacity: 70L
- Collection funnel capacity 10L
- Dimensions: 35x48x163cm
- Medium: Engine oil and gear oil
- Big capacity tank.
- Handle to facilitate manipulation.
- Wheels to facilitate the transport.

SPARE PARTS AVAILABLE



REF.	CARACTERÍSTICAS	Kg	Sub	U	U	€
15018	Eva tray oil drain plug socket set of 22pcs	1,45	-	10	480	46,00€
14937	Wheel for oil collector 80l	0,30	-	14	-	9,50€
15305	Hose with hook tap	0,65	-	40	-	19,50€
15307	Funnel	2,10	-	10	40	39,60€
15309	Conection tube	0,75	-	20	-	17,00€
15312	Fitting for connecting the diposit and the hose	0,10	5	40	-	11,50€
15308	Small swiveling wheel	0,35	-	40	-	7,00€



OIL TRANSFER PUMP 12V

53566 32,00€

1,00	5	10	210
Kg	sub	ff	ff

- Oil pump ideal for quick and clean oil-changes.
- It works by connecting the clamps to the 12V car battery.
- The oil is simply drawn out the motor through the oil dipstick bore.
- Useful for motor oil, diesel oil or heating oil.



12V	70 dB(A)	5A
2.5(m/s)	MOTOR-OIL 1L/min	DIESEL-OIL 2L/min

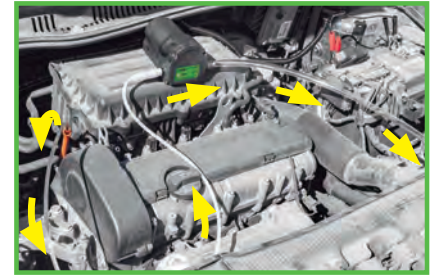

OIL AND FUEL EXTRACTION KIT

53627 22,50€

0,55	-	12	96
Kg	sub	ff	ff

- Designed and manufactured to provide for quick and easy removal of oil, gas, and transmission / differential fluids from the reservoirs of generators, pressure washers, air compressors, lawn and garden tractors, or ATV's.



BATTERY FLUID TESTER - DIAL TYPE

53453 7,00€

0,10	24	96	384
Kg	sub	ff	ff

-43°C ~ 131°C



MAT WITH TANK MAT FOR FOOTWEAR DISINFECTION

53862 6,00€

1,45	-	5	100
Kg	sub	ff	ff

- Size: 85x55x10cm
- Material: TPE
- Max. recommended capacity: 3L
- Max. capacity: 8L

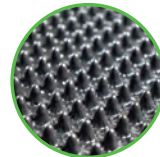

DRYING CARPET

53863 3,00€

0,70	-	5	240
Kg	sub	ff	ff

- Size: 76x48cm
- Material: Polyester

ALCOHOL REFRACTOMETER

50731 68,00€

0,56	-	5	500
Kg	sub	ff	ff

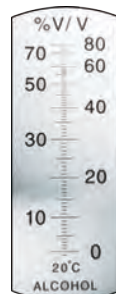

UNIVERSAL REFRACTOMETER

52963 49,00€

0,28	5	20	460
Kg	sub	ff	ff

- Ethylene glycol: -50°C ~ -0°C.
- Propylene glycol: -50°C ~ -0°C.
- Cleaning fluid: -40°C ~ -0°C.
- UREA AUS32: -30% ~ 35%.
- Battery: -1.100 - 1.400 sg/l.

UREA AUS32



AUTOMATIC TRANSMISSION OIL EXCHANGE MACHINE

54050 980,00€

Allow you to automatically change the transmission oil.

25,45	-	1	4

- Power source: 12 V (car battery)
- Pump power: 70 W
- Oil pressure gauge diameter: 70 mm (both oil pressure gauges)
- Oil pressure gauge range: 0-10 bar (0-150 psi) (both oil pressure gauges)
- Fresh oil tank capacity: 30 liters
- Used oil tank capacity: 30 liters

It includes:

- 1 exchange and flushing device
- 1 adapter set with 37 connecting adapters / hose adapters
- 1 red connecting hose with quick coupler, length 250 mm, diameter 12,5 mm (1/2"), max. 20 bar (300 psi)
- 1 black connecting hose with quick coupler, 250 mm long, diameter 12,5 mm (1/2"), max. 20 bar (300 psi)



It includes a case with adaptors for different brands (Volkswagen, BMW, Land Rover, Ford, Mercedes, Buick).



12V BATTERY CLAMPS

SET OF ADAPTORS FOR REF.54050

15539	1.30	5	
104,00€			

FILTER ELEMENT

15542	0.10	20	
45,00€			

O-RING FOR OIL INLET (REF.54050)

15480	0.00	-	
0,99€			

7,5L TRANSMISSION OIL FILLING SYSTEM

52797 198,00€

5,00	-	1	24

- Capacity: 7,5L.
- Hose: 80cc cycle.
- Viscosity range: SAE 140.
- Allows filling and emptying

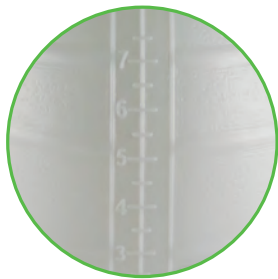

TRANSMISSION OIL FILLING SYSTEM WITHOUT ACCESSORIES FOR REF. 52797

13234	3.75	1	24
224,50€			



ADAPTORS SET FOR TRANSMISSION OIL FILLING SYSTEM

12044 147,00€

1.32	-	20	120

101
FORD 1/8 - 27 (NPT)

102
UNIVERSAL, BMW, HONDA, NISSAN, etc

103
VW/AUDI, SKODA

104
VW/AUDI, PORSCHE

105
VW/AUDI, MINI COOPER M10x1.0

106
VW/AUDI DSG M24x1.5

107
VW/AUDI CVT M22x1.5

108
MERCEDES M12x1.5

109
VW/SKODA M18x1.5

110
AUDI/VW, SKODA, M30x1.5

111
UNIVERSAL FLEXIBLE 300mm, HONDA, HYUNDAI, KIA, etc.

112
VOLVO 5/16 - 24 (UNF)

113
TOYOTA, LEXUS M18x1.0

114
NISSAN, INFINITI M8x1.0

115
ATF - ADAPTER VW PASSAT



15 PCS

DIESEL PUMP PRIMING TOOL

52801 26,00€



0.10	5	50	600
Kg	sub	ft	ft

- During replacement of the injection pump, filters or other parts it prevents retraction of the fuel to the tank.
- After the assembly of parts to replace pump, it allows to pump the fuel to the injection line.



EMERGENCY FUEL TRANSFER PUMP

52789 15,20€

0.15	10	24	192
Kg	sub	ft	ft

- Hose 90cm long for each end.



1/2" OIL HOSE REEL 15M

50797 490,00€

26.60	-	1	14
Kg	sub	ft	ft

Oil hose spool
Hose length: 15+1 m
Max working pressure: 160 bar
Inlet: 1/2" BSPT
Outlet 1/2" BSPT
Material: Steel



15m **160 BAR**



FUEL RETRIEVER

52498 58,00€

0.85	-	10	120
Kg	sub	ft	ft

- Made from polypropylene.
- Transparent body.
- Fit for transmissions and differential.
- Resistant to brake liquid and antifreeze.

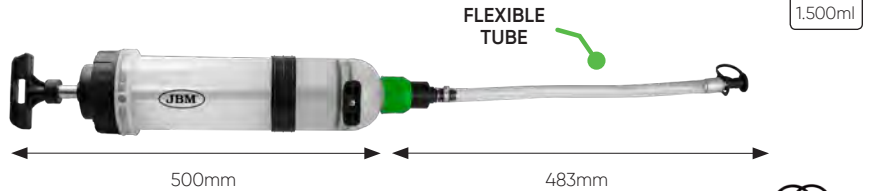

O-RINGS REPLACEMENT (X2) FOR REF. 52498

11867 9,00€ 0.02 Kg 100

52628 26,50€

0.25	5	20	360
Kg	sub	ft	ft

200ml

- Useful for brake liquid.
- Quick connector.

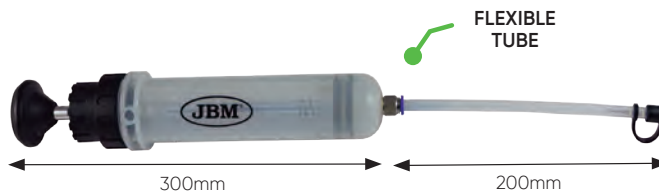

OIL SUCTION GUN

51928 14,00€

0.82	5	20	420
Kg	sub	ft	ft



CHRO-MED 500ml

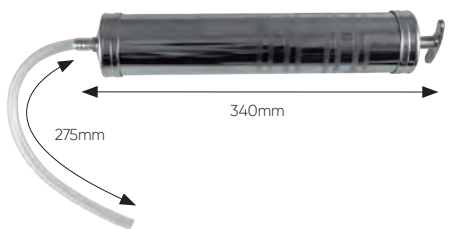

MINI GREASE GUN

53849 16,10€

0.30	-	40	880
Kg	sub	ft	ft

- This handy mini grease gun is perfect for boats, motorbikes, e-bikes, bicycles, or any other machines or equipment that needs lubricating.
- Very comfortable to work with one hand.

- 0.5 mm Nozzle Tip.
- External taper 50 degrees.
- Spring loaded pump.



3-WAY SIDE LEVER GREASE GUN

50852 24,50€

500ml

1.30	5	20	240
Kg	sub	ff	ff



PNEUMATIC GREASE GUN

50751 43,00€

1.50	5	10	150
Kg	sub	ff	ff

- Rigid tube
- Flexible tube
- Pressure: 30 Mpa



QUICK RELEASE GREASE COUPLER

53592 25,00€

Recommended to be used with JBM grease guns ref. 50751 and ref. 50852, although it can be used on most hand, battery powered or air grease guns and bulk grease pumps.

0.15	25	100	-
Kg	sub	ff	ff

- Ergonomic thumb lever design makes coupling and uncoupling effortless and saving time.
- Compatible with all sizes / forms and it fits all SAE and metric grease fittings.
- Integrated Non-Return Valve enables unit to be disconnected easily at pressures up to 15.000PSI (1.034Bar).
- Integrated 1/8" NPT Connection.



- Hardened 3-Jaws withstands high pressures without deformation.



SET OF ACCESSORIES FOR GREASE GUN

54255 68,00€

1.60	-	10	500
Kg	sub	ff	ff

300mm

7 PCS 360°

330mm 90°

- x1
- x1
- x1
- x1
- x1
- x1



PVC PANS

High resistance PVC / Compact.

18L FLUID DRAIN PAN

53215 19,00€

0.95	-	6	60
Kg	sub	ff	ff

18L

- Dimensions: High: 185mm / Diameter: 380mm.



18L OIL DRAIN PAN

53144 18,00€

0.99	-	6	48
Kg	sub	ff	ff

18L

- Dimensions: High: 185mm / Diameter: 380mm.



8L PORTABLE OIL DRAIN COLLECTOR

54051 39,00€

1.95	-	4	32
Kg	sub	ff	ff

110mm

600mm

330mm

8L

PE



STEEL TRAY FOR LIQUIDS

51356 48,00€

3.00 - 5 30
Kg SUB ff

23 L

110mm 400mm 600mm



PUMP OILER 250ml

52243 8,50€

0.14 5 60 720
Kg SUB ff

250ml

130mm

125mm

FILLING CAN

52991 10,50€

0.16 - 20 240
Kg SUB ff

2L

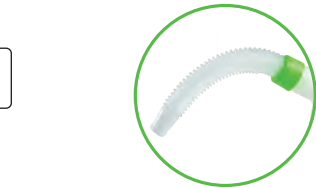

52992 18,00€

0.30 - 8 96
Kg SUB ff

5L

PUMP OILER 500ml

52242 12,00€

0.28 10 60 480
Kg SUB ff

160mm

120mm

200L BARREL FUNNEL WITH LID AND FILTER

53187 39,00€

0.75 - 18 54
Kg SUB ff

4,5L

- Ø Interior: 245mm.
- Ø Exterior: 255mm.

FILTER

SET OF 3 FUNNELS

53188 7,00€

0.15 - 24 288
Kg SUB ff

Ø 90mm
130mm
180mm

FUNNEL WITH FILTER

52391 5,00€

0.09 5 20 240
Kg SUB ff

950ml

140 x 15mm

FUNNEL WITH FLEXIBLE HOSE

53198 9,50€

0.15 - 24 144
Kg SUB ff

Ø 180mm

1,89L

530mm



HYDRAULIC TOOLS

- 260 TROLLEY JACKS
- 262 BOTTLE JACKS
- 263 CAR JACK STANDS
- 265 CAR TIRE DOLLYS
- 266 PRESSES
- 267 CRANES
- 268 ENGINE SUPPORTS
- 269 MOTORCYCLE LIFTER
- 270 MANUAL PALLET JACK

3T HEAVY DUTY TROLLEY JACK - FAST PUMP SYSTEM

53725 248,00€

32,00 - 1 18



↑ 465mm
↓ 133mm



CONFORMS TO: EN 1494:2001

344mm 682mm 155mm

CUP WITH RUBBER PROTECTION



NYLON WHEELS



REFILL PISTON

14709 122,00€ 6.15 5 Kg

3T HYDRAULIC JACK WITH LIFTING PEDAL

53422 368,00€

44.50 - 1 15



↑ 533mm
↓ 100mm



372mm 778mm 165mm

CUP WITH RUBBER PROTECTION

FOAM

LIFTING PEDAL



NYLON WHEELS

SWIVEL CASTER FOR REF.53422

14071 21,50€ 25

FIXED CASTER FOR REF.53422

14072 21,50€ 25

PISTON FOR REF.53422

14073 128,00€ 3

3T TROLLEY JACK WITH PEDAL

53112 298,00€

39.95 - 1 18



↑ 520mm
↓ 140mm



345mm 720mm 185mm



FAST ELEVATION



REFILL PISTON FOR JACK REF. 53112

13853 122,00€

RUBBER PROTECTOR FOR TROLLEY JACK REF. 53112

13836 9,00€

2T HEAVY DUTY TROLLEY JACK - LOW CARS

53421 298,00€

33.50 - 1 18



↑ 505mm
↓ 75mm



DOUBLE PISTON



360mm 740mm 150mm

CUP WITH RUBBER PROTECTION

FOAM



NYLON WHEELS

SWIVEL CASTER FOR REF.53421

14068 13,00€ 50

PISTON FOR REF.53421

14070 116,00€ 4

FIXED CASTER FOR REF.53421

14069 13,00€ 50

2,5T HEAVY DUTY TROLLEY JACK - LOW CARS

54137 288,00€

30.65 - 1 18



↑ 505mm
↓ 78mm



740mm 350mm 150mm



3,5T HEAVY DUTY TROLLEY JACK

50818 198,00€

346mm 685mm 180mm

35,80 - 1 18
Kg SUB if

495mm
133mm
3,5T



CE
EN 1494:2001



RUBBER FOR PLATE FOR REF. 50818

14615 0,05 100
9,50€ Kg if

PISTON FOR REF. 50818

10768 6,35 4
113,00€ Kg if

LATERAL SUBJECTION SCREW FOR REF. 50818

10639 0,34 5
10,90€ Kg if

SUPPORT FOR REF. 50818

10769 0,30 1
21,00€ Kg if

CRICK SPRING FOR REF. 50818

10770 0,05 50
6,00€ Kg if

2T HEAVY DUTY TROLLEY JACK - LOW CARS

50816 88,00€

208mm 508mm 125mm

11,25 - 1 63
Kg SUB if

340mm
90mm
2T



CE



REFILL PISTON FOR REF. 50816

14708 10
59,00€ Kg if

2T HYDRAULIC TROLLEY JACK

53968 49,00€

205mm 490mm 140mm

5,80 - 1 90
Kg SUB if

300mm
130mm
2T



CE EN 1494:2001



2T HANDCART HYDRAULIC JACK

50815 88,00€

205mm 490mm 140mm

10,75 - 1 56
Kg SUB if

355mm
130mm
2T



CE



REFILL PISTON FOR JACK REF. 50815

11939 6,00 5
63,00€ Kg if

2T HEAVY DUTY TROLLEY JACK IN PLASTIC BOX

51895 99,00€

205mm 490mm 140mm

11,68 - 1 42
Kg SUB if

355mm
130mm
2T



CE



PISTON FOR JACK REF. 51895

11939 6,00 5
63,00€ Kg if

VAT not included

JBM / www.jbmcamp.com

261

20T BOTTLE JACK

50823 94,00€

10,18 - 2 - 96
Kg SUB

↑ 452mm
↓ 242mm

20T

CE



20T BOTTLE JACK -LOW CARS

50824 88,00€

8,47 - 2 - 120
Kg SUB

↑ 335mm
↓ 190mm

20T

CE



30T BOTTLE JACK

50825 154,00€

7,62 - 2 - 96
Kg SUB

↑ 465mm
↓ 285mm

30T

CE



BOTTLE JACK 2 - 15T

50819 28,00€

2,42 - 6 - 330
Kg SUB

↑ 345mm
↓ 181mm

2T



50822 59,00€

5,60 - 4 - 160
Kg SUB

460mm
↓ 230mm

10T



50820 34,50€

3,20 - 6 - 300
Kg SUB

↑ 372mm
↓ 194mm

3T



52304 84,00€

7,20 - 2 - 136
Kg SUB

↑ 365mm
↓ 225mm

15T

CE



50821 47,00€

4,10 - 5 - 200
Kg SUB

↑ 413mm
↓ 216mm

5T



BOTTLE JACK PLASTIC BOX

51905 34,50€

2,90 - 6 - 144
Kg SUB

↑ 340mm
↓ 185mm

2T



51906 39,00€

3,53 - 4 - 144
Kg SUB

↑ 385mm
↓ 195mm

3T



51907 48,00€

4,59 - 4 - 128
Kg SUB

↑ 450mm
↓ 215mm

5T



CE



3T HEAVY DUTY FARM JACK

53895 107,00€

9,15 - 1 - 42
Kg SUB

↑ 330mm
↓ 130mm

↑ 510mm
265mm
140mm



53896 127,00€

11,60 - 1 - 28
Kg SUB

↑ 645mm
↓ 130mm

↑ 840mm
265mm
140mm



53897 140,00€

13,85 - 1 - 21
Kg SUB

↑ 1045mm
↓ 130mm

↑ 1220mm
265mm
140mm



53898 148,00€

15,65 - 1 - 21
Kg SUB

↑ 1320mm
↓ 130mm

↑ 1520mm
265mm
140mm



- Material: 45 steel



LIFT MATE

15096 40,00€

2,00 - 10 - 560
Kg SUB

↑ 340mm
87mm
142mm



Designed to lift the vehicle directly from the wheel when higher lifting height capacity is required.

HANDLE LOCK

15095 13,00€

0,10 - 50
Kg SUB

↑ 125mm
62mm
16mm



Designed to lock the jack handle in place during transportation.

WHEEL MOUNT BRACKET

15093 38,00€

3,65 - 1 - 50
Kg SUB

↑ 175mm
175mm
158mm



Designed to keep the farm jack secure on the 4x4 external spare wheel mount for transportation when going off-road. Its adjustable base makes it suitable for most vehicles.

OFF-ROAD BASE

15094 39,50€

1,35 - 5 - 140
Kg SUB

↑ 293mm
293mm
10mm



Designed to stabilize the jack on soft ground by increasing the support area and avoiding sinking.

2 PCS. CAR JACK STANDS

53779 36,00€

5,05	-	1	72
Kg	Sub	Box	Tray

195mm 205mm

430mm
290mm

3T **2 PCS**



53845 64,00€

9,35	-	1	30
Kg	Sub	Box	Tray

230mm 260mm

610mm
370mm

6T **2 PCS**



54143 249,00€

35,50	-	1	12
Kg	Sub	Box	Tray

500mm
700mm

12T **2 PCS**



SCISSOR JACK

53218 26,00€

2,25	-	6	216
Kg	Sub	Box	Tray

1,5T 370mm
90mm



- Suitable for all cars.

ALUMINIUM CAR JACK STAND

53200 69,00€

4,70	-	1	72
Kg	Sub	Box	Tray



385mm
245mm

3T



54144 298,00€

28,00	-	1	18
Kg	Sub	Box	Tray

338mm
500mm

22T

2 PCS



54145 377,00€

1,80	-	1	4
Kg	Sub	Box	Tray

482mm
775mm

10T

2 PCS



54146 492,00€

2,00	-	1	4
Kg	Sub	Box	Tray

736mm
1212mm

10T

2 PCS



AXLE STAND 1,8 T

54147 198,00€

0,80	-	1	6
Kg	Sub	Box	Tray

1200mm
2146mm

1,8T

1 PCS



HYDRAULIC TRANSMISSION JACK

54001 285,00€

28.50	-	1	20
Kg	sub	ft	ft

↑1.900mm
↓1.100mm

900mm

500
KG CE

- Lifting range from 116 to 197 cm.
- Allows lifting and moving safely gearboxes, differentials, tanks, etc.
- Double position support.
- Comfortable and fast elevation with pedal.
- Spring valve for controlled decline.

SET OF 4 WHEELS

15526 3,00 25
48,00€ Kg ft

PISTON

15527 15,00 -
276,00€ Kg ft

DOUBLE POSITION SUPPORT

15528 1,95 -
39,00€ Kg ft

2 POSITIONS

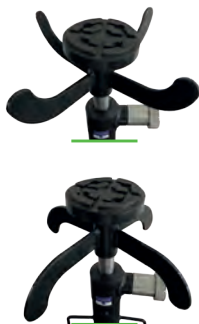

WITH SAFETY VALVE

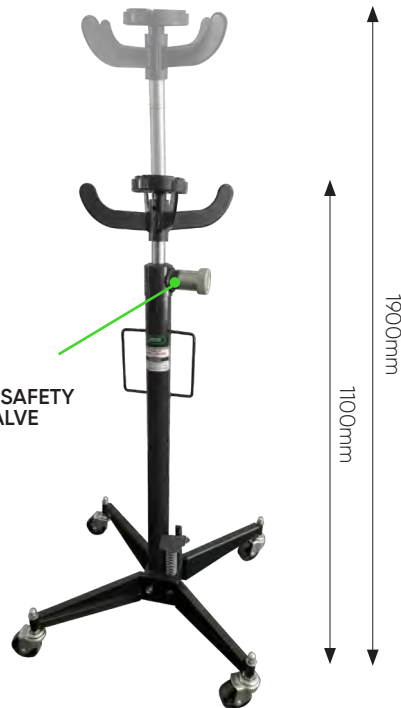

HYDRAULIC TRANSMISSION JACK

50830 560,00€

52.10	-	1	6
Kg	sub	ft	ft

- With handle.
- Double piston.

500
KG

↑1.740mm
↓850mm

CE



DOUBLE POSITION SUPPORT FOR 50830

14929 1,95 10
35,00€ Kg ft

Useful for jacks purchased previously that do not have it incorporated.

REPLACEMENT PISTON FOR REF. 50830

12046 28.50 -
385,00€ Kg ft

SADDLE FOR REF.50830

10962 10.60 -
85,00€ Kg ft

HYDRAULIC HAND PUMP

54257 318,00€

11.40	-	1	32
Kg	sub	ft	ft

Working pressure:
Stage 1: 0-20 kg/cm³
Stage 2: 20-700 kg/cm³

Flow:
Stage 1: 13cc
Stage 2: 2.3cc



3/8" NPT

1,8m

1000 PSI

CE

1T CAR TYRE DOLLY

51901 999,00€

75,00	-	1	10

- Length: 1040mm.
- Width: 1090mm.
- Height: 890mm.
- Max. wheel diameter: 1.320mm.
- Working range: 50-100mm.



1T	890mm	1040mm	1090mm	CE
-----------	-------	--------	--------	-----------



1,5T HEAVY DUTY WHEEL DOLLY FOR TRACTOR TYRES

52241 1.690,00€

139,00	-	1	5

- Capacity: 1.5T
- Lifting range: 0-770mm
- Total length: 1270mm
- Total width: 990mm
- Total height: 1340mm
- Maximum wheel diameter: 2200mm (86")
- Minimum wheel diameter: 1000mm (39")
- Maximum wheel width: 800mm

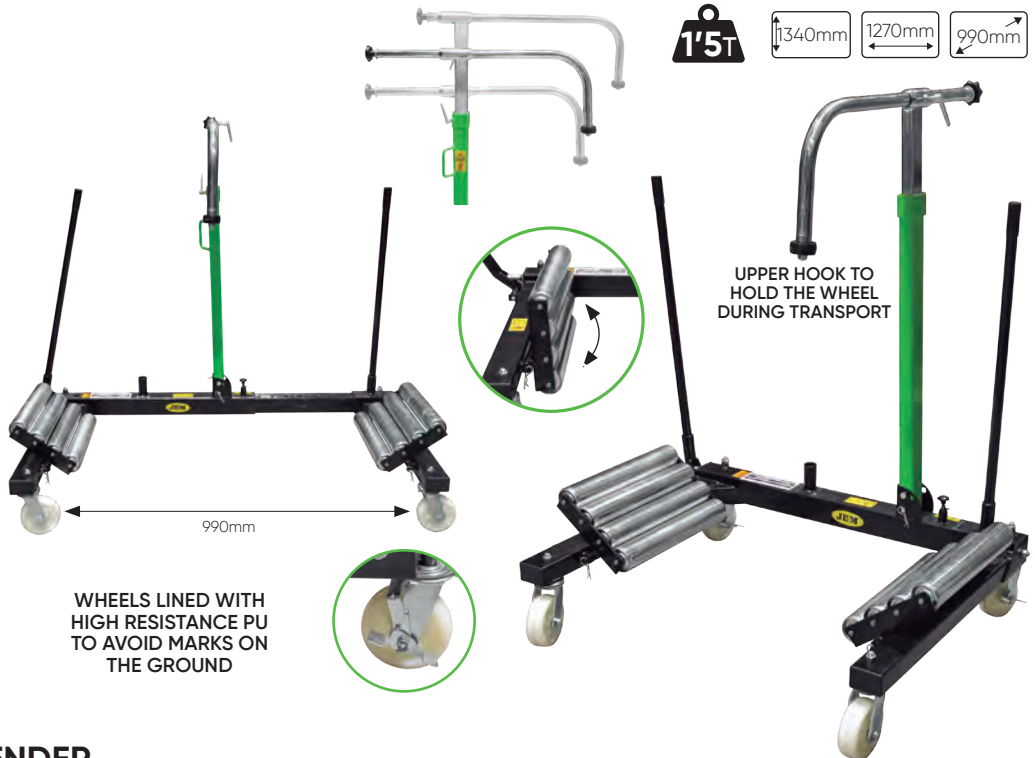

1.5T	1340mm	1270mm	990mm	CE
-------------	--------	--------	-------	-----------

UPPER HOOK TO HOLD THE WHEEL DURING TRANSPORT



WHEELS LINED WITH HIGH RESISTANCE PU TO AVOID MARKS ON THE GROUND

990mm

HYDRAULIC PIPE BENDER

50835 290,00€

35,50	-	1	14

DESIGNED FOR VERTICAL AND HORIZONTAL USE

- Bend pipes up to 2" (50mm).
- Designed to use horizontal / vertical.
- Adjustable bars.
- Cap. Max.: 12T
- Pressure air: 0,75 - 0,85mpa
- Measure: 68x58,5x18,5cm
- Bending die sizes: 1/2", 3/4", 1", 1-1/4", 1-1/2", 2".



12T	680mm	585mm	185mm	CE
------------	-------	-------	-------	-----------



PUMP	13870	6.70	1
	82,00€		

BENDING DIES 6PCS SET	15255	8.75	1
	114,00€		

30 TON PRESS

53684 1.880,00€

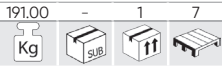

- Side Stroke (mm): 200.
- Stroke (mm): 160.
- Working range (mm) for pedal.
- Base width (mm): 540.

30T CE

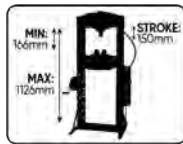

20 TON PRESS

53590 1.190,00€

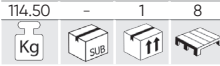

- Capacity (T): 20.
- Stroke (mm): 145.
- Working range (mm): 58-1018.
- Base width (mm): 540.
- Inner width (mm): 536.
- Side Stroke (mm): 180.

20T CE

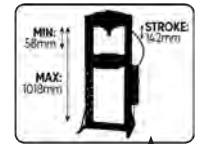

HAND LEVER AND FOOT PEDAL



HORIZONTAL DISPLACEMENT



HAND WINCH TO ADJUST THE HEIGHT OF THE PRESS TABLE



2 SPEED

GRID GUARD

14616 96,00€

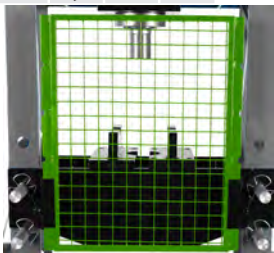
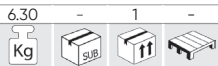

PISTON

15044
259,00€

GRID GUARD

14616
96,00€

GAUGE

15047
47,00€

LEVER

15048
5,00€

GAUGE

15046
47,00€

PISTON

15043
195,00€

LEVER

15048
5,00€

PUMP

14639
195,00€

HYDRAULIC PRESS SUPPORT BLOCK

52999 168,00€



BIG BLOCK



SMALL BLOCK



30T CE

2T COLLAPSIBLE CRANE

50831 460,00€

79.50 Kg 1 SUB 1 20

↑ 1.460mm | 1.060mm | 1.750mm

2T CE

↑ 2.620mm | ↓ 60mm

Lifting range:
180m (2T) - 2,19m (½T)
- Dimensions extended:
800 x 680 x 1.600mm.
- Elevation capacity:
Position 1: 2T - 80mm.
Position 2: 1½T - 255mm.
Position 3: 1T - 425mm.
Position 4: ½T - 610mm.



80cm | 68cm | 940mm

1T COLLAPSIBLE CRANE

52985 598,00€

74.00 Kg 1 SUB 1 9

1T CE

146cm | 46cm | 60cm

(Min./Max.): 82/105cm

95cm | 133cm



ROTARY WHEELS FOR REF. 50831

12032 7,50€

5.20 Kg 6

PISTON FOR REF. 50831

14090 103,00€

10.30 Kg 1

SCREW SET FOR REF. 50831

11323 16,00€

2.04 Kg 1

SPARE PISTON FOR 52985

13672 220,00€

10.82 Kg 1

O-RING FOR PISTON - 52985

14589 2,50€

0.10 Kg 100

ENGINE LEVELER 750KG

50631 68,00€

6.30 Kg 1 SUB 1 100

CRANE NOT INCLUDED.

750 KG CE



MANUAL SPRING COMPRESSOR

50827 387,00€

32.90 Kg 1 SUB 1 15

1T CE

190mm | 350mm | 830mm

200-500mm

- Capacity: 1T (2200 lbs)
- Compressed spring diameter: 200mm
- Compression length: 200-500mm



STEEL PLATFORM CART

	54262 88,00€	54263 130,00€	54264 240,00€
Lifting height	2,8M	2,8M	2,8M
Chain falls	1	2	2
Chain measurements	Load chain: 6x30mm	Load chain: 6x30mm	Load chain: 6x30mm
	Hand chain: 4,5x25mm	Hand chain: 4,5x25mm	Hand chain: 4,5x25mm
Length	Load chain: 3m	Load chain: 3m	Load chain: 3m
	Hand chain: 2,5m	Hand chain: 2,5m	Hand chain: 2,5m
Effort for maximum load	304N	310N	361N
Material	Load chain: Steel 20Mn2	Load chain: Steel 20Mn2	Load chain: Steel 20Mn2
	Hand chain: Steel Q235	Hand chain: Steel Q235	Hand chain: Steel Q235

1T | **2T** | **5T**

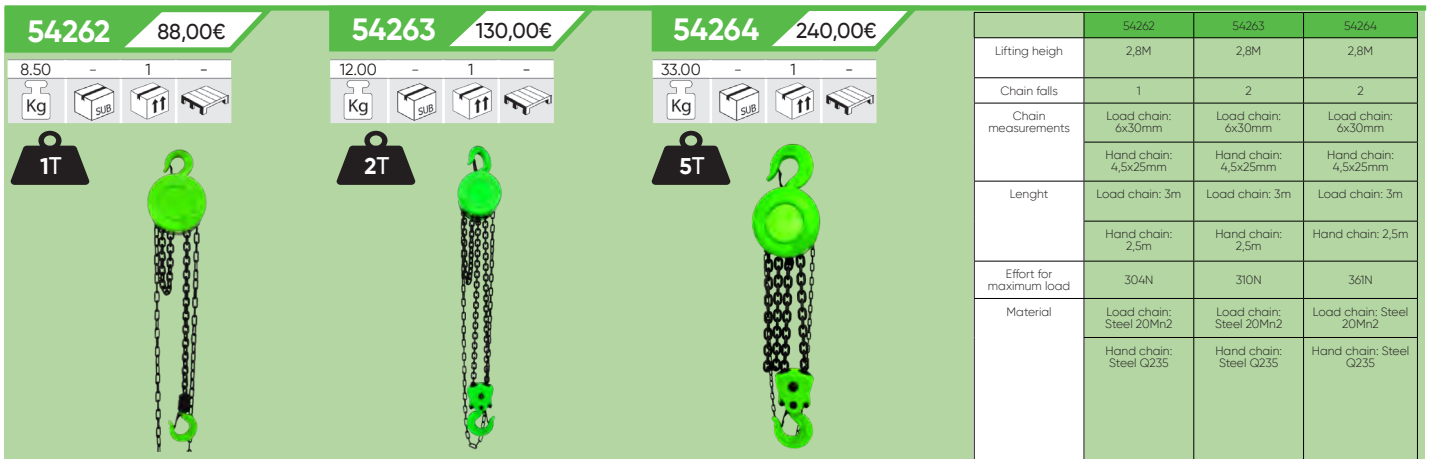

ENGINE GEARBOX SUPPORT

50840 138,00€

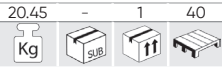

1750mm



HOOK AND HANDLE
FOR REF. 50840

51452
69,00€

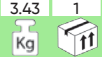

53682 98,00€

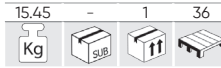

1480mm



UNIVERSAL ENGINE SUPPORT

52055 129,00€

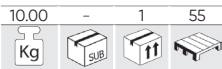

- Adaptable to any kind of automobiles and vans.
- Ideal for changing the timing belt and auxiliary belt.
- Simple use.
- Fast positioning; only one worker is needed.
- Perpendicular piece with turn angle. It's adjustable to any length of the longitudinal bar.
- Adjustable hook height, 360° hook rotation.
- Plastic tray to prevent the footing bar shift.



UNIVERSAL ENGINE STAND

50836 148,00€

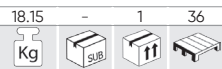

850mm

900mm

800mm



50838 299,00€



900mm

1,100mm

900mm



- Folded dimensions:
100 x 50 x 44cm.

MOTORCYCLE STAND LIFT

53969 96,00€



328mm

293mm

400mm
300mm

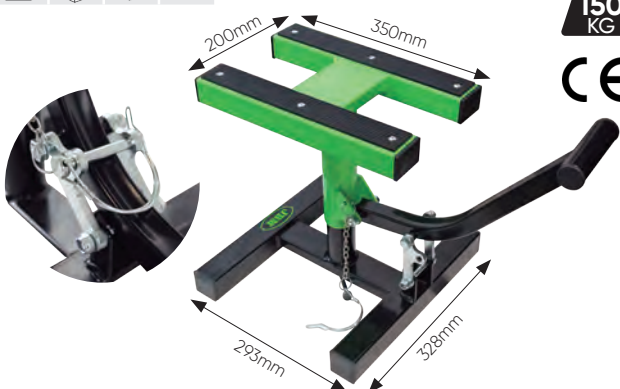

MOTORCYCLE STAND LIFT JACK

52692 129,00€

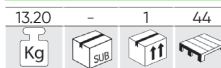

400mm
95mm



- Operated with 21mm socket.



HYDRAULIC LIFT TABLE 360KG

53246 1.144,00€

104.00 - 1 4
Kg SUB

↑ 1.350mm
↓ 370mm **360 KG**



HYDRAULIC LIFT TABLE 400KG

50630 590,00€

63.00 - 1 4
Kg SUB

480mm 840mm ↑ 780mm ↓ 290mm **400 KG**



REFILL PISTON FOR REF. 50630

10993 8.80 1
117,00€ Kg

REPLACEMENT PISTON FOR HYDRAULIC TABLE REF. 50630

11950 0.03
18,00€ Kg

HYDRAULIC LIFT TABLE FOR MOTORCYCLES

50911 788,00€

135.00 - 1 5
Kg SUB

↑ 780mm ↓ 205mm **365 KG**



SET OF 2 WHEELS WITH BRAKE FOR 50911

14706 0.00 -
8,90€ Kg

REFILL PISTON FOR REF. 50911

14727 7.10 1
108,00€ Kg

HYDRAULIC MOTORCYCLE SCISSOR LIFT

51750 299,00€

31.00 - 1 12
Kg SUB

500mm 450mm 340mm ↑ 890mm ↓ 340mm **135 KG**



ATV JACK

53423 199,00€

29.40 - 1 24
Kg SUB

790mm 370mm 330mm **680 KG**



NYLON ↑ 368mm ↓ 118mm



REFILL PISTON FOR REF. 53423

14291 4.60 3
87,00€ Kg

NYLON WHEELS

SET OF 2 CAR RAMPS 1T

52845 170,00€



20,00	-	1	8
Kg	sub	ft	tr

- Useful for the presentation of vehicles in exhibition, as well as maintenance work at the bottom of the vehicle.

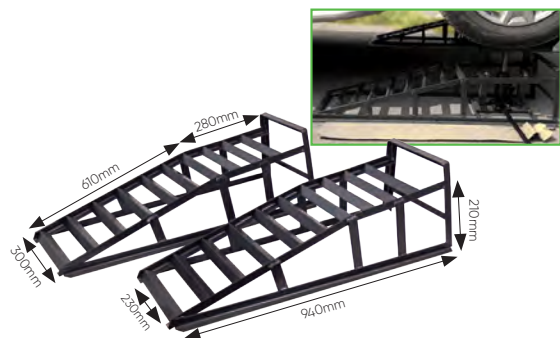

MOTORCYCLE PADDOCK STAND

FRONT

52514 84,00€



4,00	-	1	26
Kg	sub	ft	tr



MOTORCYCLE LIFT

FLATS (x2)

10671	0,63	2	255mm
15,20€	Kg	ft	

BACK

51751 99,00€



5,00	-	4	12
Kg	sub	ft	tr



ROUNDS (x2)

11892	0,15	50	20mm
12,50€	Kg	ft	

HYDRAULIC WHEEL MOVER 680Kg

50839 180,00€



19,20	-	1	10
Kg	sub	ft	tr

- Black plastic legs length: 300mm.
- Length with wheels: 600mm.



PISTON FOR REF. 50839

15085	5,30	1
156,00€	Kg	ft

WHEELS FOR REF. 50839

12889	0,65	30
12,00€	Kg	ft

SPECIAL PLATE TRANSPORT CART

50923 454,00€



36,40	-	1	18
Kg	sub	ft	tr

- Separation: 0 to 110cm.

WHEELS FOR REF. 50923

12022	33,70€
-------	--------

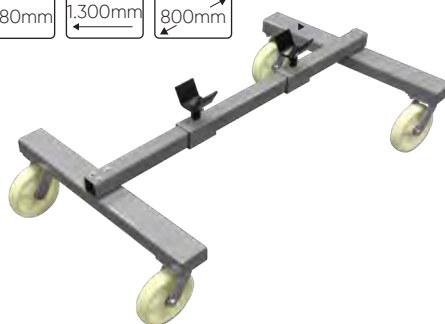

SET OF 4 TESLA LIFTING PADS

54175 34,00€

NR TESLA 3/X/S/Y

0,80	5	20	280
Kg	sub	ft	tr



MANUAL PALLET JACK QUICK LIFT

53880 598,00€



84,50	-	1	6
Kg	sub	ft	tr

- Capacity: 2500kg
- Push rod length: 1150mm
- Handle: Square handle with Rubber
- Steered wheel: PU (200x50mm)
- Loading wheel: Tandem Pu (80x70mm)
- Min Fork Height: 85mm
- Max Fork Height: 200mm
- Pump Strokes: 8



QUICK LIFT PUMP (CAST STEEL)

PU 80x70mm

FORK ROLLER

14938	1,00	10
42,00€	Kg	ft

STEERING WHEEL

14939	2,60	4
57,00€	Kg	ft

PUMP

14940	9,35	1
248,00€	Kg	ft

SET OF 2 PIN FOR HANDLE AXLE

14785	0,5	-
3,50€	Kg	ft



270

ELECTRIC PALLET TRUCK

53777 4.352,00€

133,50	-	2	2
Kg	sub	ft	tr



INNOVATIVE DESIGN
- Sealed hydraulic unit
- Easy maintenance
- Low noise level
x2 keys
PU / PV WHEELS





ELECTRIC TOOLS

- 272 JUMP STARTER
- 273 BATTERY CHARGERS / TESTERS
- 274 MULTIMETERS
- 275 THERMOMETERS
- 276 ENDOSCOPES
- 277 WELDERS
- 278 BENCH GRINDERS
- 279 PARTS WASHER
- 280 VACUUM CLEANERS
- 281 HEATERS / LAWN MOWERS
- 282 HIGH PRESSURE CLEANERS
- 283 ELECTRIC CABLE REEL
- 284 FANS

STARTER CABLES

BRASS SOLID CLAMPS

REF.	Ø CABLE + COVER	LONG	A	SECTION	Kg			€
51238	17mm	5m	700	70mm ²	4.95	2	84	138,00€
51239	15mm	7m	700	70mm ²	5.90	2	72	159,00€



BRASS CLAMPS

REF.	Ø CABLE + COVER	LONG	A	SECTION	Kg			€
52069	11mm	2,5m	250	25mm ²	1.55	10	240	29,50€
52070	12mm	3m	350	35mm ²	1.95	5	160	40,00€
52071	13mm	3m	500	50mm ²	2.35	5	90	47,00€



BRASS SOLID CLAMPS WITH OVERLOAD PROTECTOR

REF.	Ø CABLE + COVER	LONG	A	SECTION	Kg			€
51363	12mm	3m	350	35mm ²	2.63	5	120	114,00€
51365	12mm	3m	600	50mm ²	3.10	5	90	118,00€



STARTER CABLE COPPER CLIPS

14145	0.20	30
8,50€	Kg	



SOLID BRASS BOOSTER CLAMPS

14147	0.35	15
25,00€	Kg	



STARTER CABLE COPPER CLIPS

14146	0.20	30
8,00€	Kg	

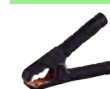

SOLID BRASS BOOSTER CLAMPS

14148	0.35	15
25,00€	Kg	



ELECTRICAL CLIP ASSORTMENT

53357	0.01	6	24
7,00€	Kg		



2 PCS 30 AMP

JUMP STARTER

53687 298,00€

11.35	-	1	14
Kg			

12V 9,5kg

- Voltage: 12V.
- Battery: 222Ah Lead-acid battery (1PCS).
- Starting current: 750A.
- Peak current: 1500A.

53688 495,00€

18.05	-	1	14
Kg			

12V 24V 16,3kg

- Voltage: 12V/24V.
- Battery: 22Ah Lead-acid battery AGM (2PCS).
- Starting/Peak current 12V: 1500A/3000A.
- 24V: 750A/1500A.
- Battery charging time: Battery completely empty: 8 hours Battery level at 10-20%: 4 hours



Clamps



12V DC 15A 230V 50Hz 12V 1A 6-40H

370mm 392mm 209mm



Internal battery voltage status



Internal battery voltage test button



On/Off switch



Charging socket



BUILT-IN LED LIGHT: increases the working area visibility



SPARE PARTS

REF.	DESCRIPTION	Kg		€
14755	22Ah battery for ref. 53687/53688	6,50	2	134,00€
14756	Printed circuit board assembly for ref. 53687	0,05	10	15,20€
14757	Printed circuit board assembly for ref. 53688	0,05	10	15,20€
14758	Red booster cable with clamp for ref. 53687	0,40	10	18,00€
14759	Black booster cable with clamp for ref. 53688	0,40	10	18,00€
15782	Black booster cable with clamp for ref. 53687	0,30	10	16,00€
15781	Red booster cable with clamp for ref. 53688	0,30	10	19,84€

Black booster cable with clamp for ref. 53687

53688



14757

15781



14759



53687



14756

14758



15782



14755



53688 53687

MEMORY SAVER FOR CHANGE BATTERY BATTERY CHARGER

52884 73,00€

0,25	5	20	360
Kg	Sub	ff	ff

12V

235mm ± 20mm

2.070mm ± 20mm

- Useful to keep current in the electrical system of the vehicle during battery change.
- OBDII connection by cable or cigarette lighter.

6/12V **53927** 66,00€

0,65	5	20	240
Kg	Sub	ff	ff

6V | 12V
7,2V | 14,4V

100V
240V

60W

50-60Hz

6V | 12V
7,4V | 14,7V

7,2VDC
0,9-3,6A

0°C
40°C

12/24V **53929** 95,00€

0,90	5	20	240
Kg	Sub	ff	ff

12V | 24V
14,4V | 28,8V

100V
240V

150W

50-60Hz

12V | 24V
14,7V | 29,4V

14,7VDC
3,6-7,2A

-20°C
40°C

COMPATIBLE WITH ALL ACID BATTERIES:
WET, GEL, MF AND AGM

INSULATION TESTER

54114 248,00€

1,48	-	10	100
Kg	Sub	ff	ff

CAT III

750V

1000V

2000MΩ

750V ~ 1000V

COM

TEST

CE

This instrument helps you measure the electrical insulation at a determined voltage (250V, 500V or 1000V). Is an indispensable tool to evaluate the integrity of an electric circuit, specially needed to check that components and installation in the electric cars are completely isolated from the bodywork. In industrial installations, is the tool that allows you to perform periodically inspections of the insulation resistance. Measurements that are required for the DIN VDE 0105-100 (VDE 0105-100):2009-10 norm. Specially indicated for use in electric and hybrid cars.

DIGITAL BATTERY TESTER

51816 49,00€

0,30	6	48	576
Kg	Sub	ff	ff

18mm

120mm

70mm

JBM

8888

CE

- 150Ah.
- For use with 12V batteries.
- Measurement in SAE (CCA), EN, IEC, DIN, CA.
- Range: 200-1200 CAA (SAE).
- Volt measurement: 7V-15 V.
- Display 4 + 3 LEDs (green, red, yellow).

BATTERY TESTER

51235 49,00€

1,25	-	10	150
Kg	Sub	ff	ff

CE

- For 6V and 12V batteries.
- Charge up to 100 Ah.
- Charge status test.
- Startup consumption test.
- Charge voltage test.
- Battery condition test.

DIGITAL BATTERY TESTER WITH PRINTER

52233 328,00€

2,32	-	6	72
Kg	Sub	ff	ff

WITH PRINTER

AGM, GEL, VRLA, SLI

CE

- For use with 6V and 12V batteries.
- Charging and opening systems of 12V and 24V.
- Operational range: 40 - 2000 CCA (SAE).

- Volt measurement: 1.5V - 30V.

- 180 cm cable set.

- Includes:
6 x 1.5 AA batteries.
1 thermal paper roll.

THERMAL PAPER
57mmx60m

51842 6,90€

0,10	6	72
Kg	Sub	ff

BATTERY HYDROMETER

53209 8,50€

0,14	24	96	768
Kg	Sub	ff	ff

CE

1.100
1.205

1.205
1.260

1.260
1.300

BATTERY TESTER WITH PRINTER

54040 240,00€

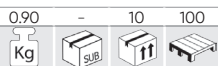

- Applicable to 12V, AGM, GEL, VRLA, SLI batteries.
- Operating Range: 100 - 2000 CCA (SAE)
- Available system languages: ES, EN, FR, DE, IT, PT, RO.
- Applicable to 12/24V starting systems.
- Applicable to 12V, AGM, GEL, VRLA, SLI batteries.
- Starter and alternator tester.

*One CR2032 battery included



WITH
PRINTER



Aplicable a sistemas de arranque de 12V 24V



100 - 2000 CCA (SAE)

DIGITAL CLAMP AMMETER

52382 19,50€

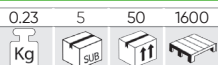

- FUNCTIONS: Live wire test.

- Voltage AC, DC, Current AC test, electric current resistance, diode test, etc.
- Operating: 0°C a 40°C, a <80%RH.

52952 74,00€



- FUNCTIONS: Live wire test. Diode test. continuity test. ADP Function. Phase detection function. ZERO Switch.

- Storage: -10°C a 40°C, a <85%RH.
- 2 batteries sizes AAA.
- Indicator battery low.
- Screen 3,5" with 4 digit.
- DC function.
- Medidor AC/DC.

	52382	52952
DCB	600V	20V, 600V
ACB	600V	600V
DCA		200A
ACA	20A, 200A, 600A	200A
OHM	2KΩ, 200KΩ, 2MΩ	2000Ω



52382

52952

DIGITAL MULTIMETER

50942 28,00€

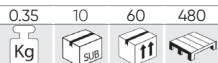

- Digits: 3 1/2.
- Measurement: 2000.
- Instantaneous data.
- Automatic shut-off.

- Battery indicator.
- 9 V batteries.
- Temperature gauge.
- Temperature -40 °C to 1000 °C.



GRIFFIN
PROTECTOR



V — AC	200mV, 2V, 20V, 200V, 1000V	A — AC	20mA, 200mA, 20A
V — DC	200mV, 2V, 20V, 200V, 750V	A — DC	20mA, 200mA, 20A
Ω	200Ω, 2KΩ, 20KΩ, 200KΩ, 2MΩ, 20MΩ, 2000MΩ		
F	2nF, 20nF, 200nF, 2μF, 20μF, 200μF		

CE

MEASURING LINE/MULTIMETER TEST FOR REF. 50942

52439 227,00€



- 2 variable resistance meter.
- 2 test light led.
- 2 SRS substitution and prove dispositives.
- 2 Alligator pliers.
- 2 Latching sockets.
- 4 probe.
- 24 round connectors.
- 48 flat connectors.



CE

MULTIMETER ACCESSORIES SET

52231 49,00€

0.41	5	20	240
Kg	Sub	ff	ff

- Suitable for most of the multimeters.

- Includes:
2 probes.
2 little clamps.
2 large clamps.
extension cables.



ANTI-ZAP PROTECTOR 12/24V

54256 48,00€

0.45	-	20	800
Kg	Sub	ff	ff

12V
24V

35V

800 AMP

1500W



AUTOMOTIVE CIRCUIT TESTER

53028 5,80€

0.70	10	120	1440
Kg	Sub	ff	ff

6-12-24V

1,8 x 190mm



- Suitable for polarity testing.

53029 6,80€

0.08	12	240	2400
Kg	Sub	ff	ff

6-12-24V

2 x 115mm



53030 12,00€

0.17	6	60	720
Kg	Sub	ff	ff

6-12-24V

LED

3 x 142mm



LASER THERMOMETER

52162 38,00€ **-50° A 550°C**

0.17	6	72	576
Kg	Sub	ff	ff

- Measurement range: from -50°C to 550°C (58°F to 1022°F).
- Precision: +/- 2°C.
- Retrolighting option.
- Pointer for a precise measurement.
- Measurement in °C/F.
- Emissivity: Adjustable (0.1-1.0).
- Response time: ≤0.8s
- Measurement block available.
- Battery 9V DC.
- Low battery indicator.



LASER

9V

-50°C-550°C
-58°F-1022°F
±2°C/±2%



52450 105,00€ **-50° TO 1.000°C**

0.72	5	20	200
Kg	Sub	ff	ff

- Measure -50°C ~1000°C / -58°F ~ 1.832°F.
- Tolerance +/-1,5°C.
- Functions:
Indication mark laser.
Temperature measurements max. or min.
Measure °C / °F.
Memory results.
Indicator low battery.
- 9v battery included.

MAX: 1000°C
MIN: -50°C

LASER

9V

-50°C-1.000°C
-58°F-1.832°F
±1,5°C

9V GP22 included



CONTACT DIGITAL THERMOMETER

53503 12,00€

0.05	20	100	2400
Kg	Sub	ff	ff

1.5V x1

-50°C-330°C
-58°F-572°F
±1°C (0,2°F)
(-20°C-80°C)



BRAKE FLUID TESTER

51839 24,00€

0.05	25	100	2400
Kg	Sub	ff	ff

- Operates with 1 x AAA batteries LR03.
- With 4 levels of measurable quality from 0-4%.



WIFI ENDOSCOPE CAMERA

53724 46,00€

0.15	-	50	800
Kg	sub	ft	ft

720p
20FPS HD



- Endoscope with Wi-Fi enabled compatible with all kind of smartphones. Able to connect with tablets and computers.

- The equipment includes:
Endoscope.
Wi-Fi connection port.
Hook tip.
Magnetic tip.
Mirror tip for side view.



2560x1920
1280x720
640x480

5MP

- Resolution: 2560x1920 / 1280x720 (720p 16:9) / 640x480 (480p 4:3).
- 20fps.
- 5 megapixels.
- Viewing angle: 70 degrees.
- Diameter: 5,5mm.
- Focal length: 4-6cm.
- IP67 water resistance (up to 1 meter).
- 2.600mAh lithium battery.

1M SEMI-RIGID CABLE

Ø 5,5MM



WORKS WITH JBM APP:



App Store

Google Play



WATCH THE TUTORIAL VIDEO IN
YouTube



INDUSTRIAL ENDOSCOPE WITH TFT SCREEN

52436 680,00€

2.41	-	5	40
Kg	sub	ft	ft



- Charge: DC5.
- Monitor 3,5TFT 320x240px.
- Interface: MINI USB 1.1/AV.
- Battery: Rechargeable Li-Polymer 3.7V.
- Adapter: 100-240V.
- AC 5VDC output.
- Video in NTSC&PAL.
- Storage: CARD SD (up to 32Gb).
- Compression: JPG.
- Recording: MPEG4 (640x480).
- Working temperature: -20°C - 60°C.
- Storage temperature: 0°C - 40°C.
- Diam. cable: 5mm.
- Functions: video output, 6 languages, auto-off, photos, videos, date/time.



COLOURED SCREEN

1M

HEAD REPLACEMENT

11992	0.01	20
65,00€	Kg	ft

CABLE 3m

11219	0.32	1
659,00€	Kg	ft

CABLE 1m

11329	0.22	1
564,00€	Kg	ft

SMOKE LEAK DETECTOR

53484 615,00€

4.70	-	4	32
Kg	sub	ft	ft

12V 6 L/m 15PSI

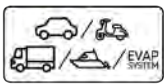

- OIL NOT INCLUDED.

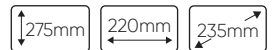

DETECTION LIQUID
500ML FOR REF 53484

14081	0.50	48	960
12,60€	Kg	ft	ft



REPLACEMENT TUBE
FOR 53484

14109	0.01	20
29,00€	Kg	ft



INFLATOR PUMP
FOR 53484

14110	0.20	20
110,00€	Kg	ft



Includes:



HEAT-MELT ADHESIVE GUN

51831 24,00€

0.35	12	36	288
Kg	sub	ft	ft

- Voltage: 100~ 230 V.
- Temperature: 190~230 °C.
- Consumption: 60~150 W.
- Ø nozzle: 2.0~2.3 mm.
- Range: 8 - 16g of product/min.



HEAT-FUSION ADHESIVE

51859	0.12	8	32	1520
3,80€	Kg	sub	ft	ft

- Ø 8mm.
- Rapid adhesion of all types of flexible materials.
- Drying time: 20'.



SOLDERING IRON

53977 17,50€

0,30	12	48	576
Kg	Sub	11	11

- Voltage 220-240V
- 40W
- Frequency: 50Hz
- Large 240MM
- Cable: 1.3m
- Max. working temperature: 450° +/- 10%



40W



CE

53111 19,00€

0,30	5	25	625
Kg	Sub	11	11

- Voltage: 220-240V.
- Temp.: 420°C +/- 10%.
- Large: 250mm.
- Cable: 1,5m.



100W

CE

MMA INVERTER WELDER 100A DC

53981 143,00€

3,35	-	1	90
Kg	Sub	11	11

100A DC

- Suitable for welding in steel and iron.
- Small size, light weight and energy-saving.
- Good arc-starting and arc force, stable arc and little spatter.
- High welding quality, deep penetration.
- Auto protection of over-voltage, over-current and over-heating.
- IGBT technology greatly improves reliability of the machine.
- It can balance automatically when input voltage is fluctuating.



- ✔ IGBT TECHNOLOGY INVERTER
- ✔ MMA DC
- ✔ ANTI STICK
- ✔ ARC FORCE
- ✔ HOT ARC START

- Includes:
- Electrode holder with 2m cable
 - Earth clamp with 1.5m cable
 - Hammer brush
 - Hand-held face shield



SPARE PARTS FOR REF. 51837

REF.	DESCRIPTION	€
15237	Electrode holder with 2m cable	12,00€
15238	Welding chipping hammer brush	5,00€
15239	Hand-held face shield	5,50€
15240	Earth clamp with 1.5m cable	9,50€
15241	Circuit board	65,00€
15242	Quick connector negative/positive	2,50€
15243	Fan	4,00€
15244	Power switch	2,00€

1ph AC 230V	50Hz	3.7 KVA Potencia Absorbida Rated Input Power	16A Intensidad Corriente máx. Max. Input Current	65V Tensión al vacío No-load Voltage
100A 24V	10-100A Intensidad de salida Output Range	0.7 Factor de potencia Power Factor	IP21S Clase protección Protection Class	F Clase aislamiento Insulation Class

53982 219,00€

6,10	-	1	33
Kg	Sub	11	11

160A DC

- Small size, stable and durable quality.
- Easy to start arc, little spatter and good formation.
- IGBT technology greatly improves reliability of the machine.
- High no load voltage and strong arc-force.
- Auto protection of over-voltage, over-current and over-heating.
- Stable welding current in spite of input voltage fluctuation, it can balance automatically when input voltage is fluctuating.



- ✔ IGBT TECHNOLOGY INVERTER
- ✔ MMA DC
- ✔ ANTI STICK
- ✔ ARC FORCE
- ✔ HOT ARC START

- Includes:
- Electrode holder with 2m cable
 - Earth clamp with 1.5m cable
 - Hammer brush
 - Hand-held face shield



SPARE PARTS FOR REF. 51837

REF.	DESCRIPTION	€
15238	Welding chipping hammer brush	5,00€
15239	Hand-held face shield	5,50€
15245	Earth clamp with 1.5m cable	7,50€
15246	Circuit board	108,00€
15247	Quick connector negative	2,50€
15248	Quick connector positive	2,50€
15249	Fan	5,00€
15250	Power switch	4,50€
15251	Electrode holder with 2m cable	15,00€

1ph AC 230V	50Hz	16A Intensidad corriente máx. Max. input current	65V Tensión al vacío No-load voltage	6.5 KVA Potencia Absorbida Rated Input Power
160A 26.4V	IP21S Clase protección Protection Class	10-160A Intensidad de salida Output Range	0.7 Factor de potencia Power Factor	F Clase aislamiento Insulation Class

HOT AIR GUN 2000W

53145 39,20€

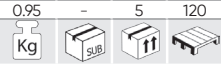

- 220V-240V.
- 50Hz-60Hz.
- 2000W.



- Output temperature: 50-600°C.
- Airflow: 220-480L / min.
- 2 temperature options: 300 and 600°C.

53162 60,00€

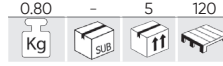

- 220V-240V.
- 50Hz-60Hz.
- 2000W.



- Output temperature: 100-600°C.
- Airflow: 280-480L/min.



DIGI-TAL

TYRE GROOVING MACHINE

52643 596,00€

MAXIMUM POWER 350W

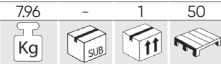

	11974 1,80€		11977 1,80€		11980 1,80€		11983 1,80€
	11975 1,80€		11978 1,80€		11981 1,80€	 DIGITALLY DIMMABLE	
	11976 1,80€		11979 1,80€		11982 1,80€		

SPARE PARTS

REF.	11974	11975	11976	11977	11978
BLADE TYPE	R1	R2	R3	R4	R5
ROUND BLADE	mm	mm	mm	mm	mm
	A	3	5	6	8
	B	7	7	10	12
	C	5	8	15	16
	D	21	21	23	25

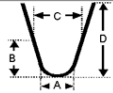

REF.	11979	11980	11981	11982	11983
BLADE TYPE	W1	W2	W3	W4	W5
SQUARE BLADE	mm	mm	mm	mm	mm
	A	3	5	7	9
	B	7	7	10	12
	C	5	6	10	13
	D	21	21	22	24

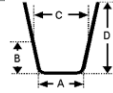

BENCH GRINDERS

450W

53656 198,00€

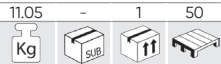

230V 450W 50Hz
2950 RPM

Ø 150mm
Ø 20mm
12,7mm

600W

53657 248,00€

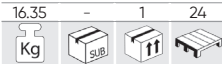

230V 600W 50Hz
2950 RPM

Ø 200mm
Ø 25mm
15,88mm

250W

53658 99,00€

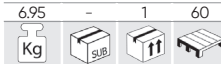

230V 250W 50Hz
2950 RPM

Ø 150mm
Ø 20mm
12,7mm

250W

53659 121,00€

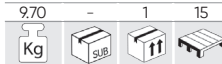

230V 250W 50Hz
2950 RPM

Ø 150mm
Ø 20mm
Ø 40mm
12,7mm
20mm



ADJUSTABLE BENCH GRINDER STAND

53660 146,00€

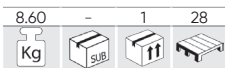

- Height: 790mm.
- Mounting plate size: 250x280mm.
- Weight: 8kg.

BENCH GRINDER 150mm

52195 170,00€

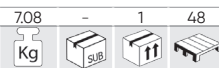

- Power entrance: 250W.
- Voltage: 230V / 50Hz.
- Velocity without charge: 2.950Rpm.
- Ø round: 150 x 20 x 12.7mm.



PARTS WASHER MACHINE

52980 480,00€

150L

- Volume: 25L.
- It works with water soluble motor cleaning solutions.

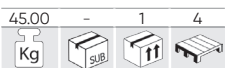

TOTAL MACHINE MEASUREMENTS

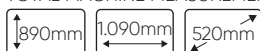

INTERIOR MEASURES DEPOSIT

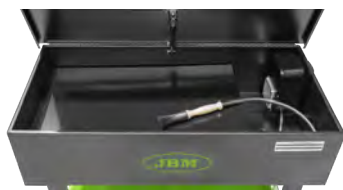
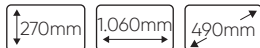

PUMP CLEANING MACHINE

11101 154,00€

CLEANER FILTER

11102 6,60€

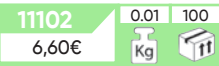

PORTABLE PARTS WASHER

53220 260,00€



- PORTABLE FORMAT.
- Allows watertight closing to avoid losses during transport.
- To be used with aqueous-based solvent.

- Side ignition switch.
- Liquid cleaning filter included.
- Tool hose and hose included.
- Storage compartment.
- Separation of work areas, cleaning area and drying area, allowing work with several pieces at a time.

- Max. Cap. 27,5L.
- Pumping capacity: 1,000 L / h.
- Working capacity: 20L.
- Connection to 220V.
- Hose of 1.10m long.

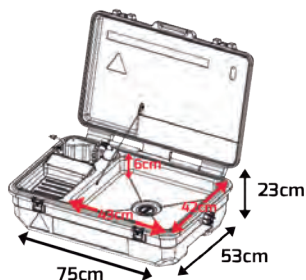

VAT not included

VACUUM CLEANER

51837 195,00€

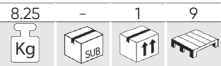

30L

DRY 30L



INCLUDED



SPARE PARTS FOR REF. 51837

REF.	DESCRIPTION	€
10720	Plastic hose 1,5m	24,50€
11095	Plastic hose 3m	31,00€
10721	Lower elbow	19,00€
10761	Filter	16,00€

51838 667,00€

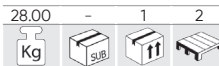

80L CE

DRY + WET 80L



INCLUDED



SPARE PARTS FOR REF. 51838

REF.	DESCRIPTION	€
10722	Plastic hose 1,5m	24,50€
11098	Plastic hose 6m	57,00€
10723	Upper elbow	29,50€
10724	Lower elbow	29,50€
10762	Filter	23,50€

	51837	51838
Capacity (L)	30	80
Suction liters per second (L/s)	26	50
Power	1x1.200W	3x1.000W
Voltage	230V	230V
Frequency	50Hz	50Hz
Suction	> 17Kpa	> 20Kpa
Ø Hose	32mm	48mm
Hose length	1,5m	2m
Cable length	4,5m	4,5m
Sealing	IPx4	IPx4

MANUAL PUSH SWEEPER

54252 199,00€



650X15mm



REF.	DESCRIPTION	€
16165	DISK SWIPE BUCKLE	2,00€
16166	SWEeper DISK BRUSH	23,50€
16167	SET OF 2 50MM WHEELS FOR 54252	7,00€
16168	TRANSMISSION BELT FOR 54252	5,00€
16169	RIGHT PINION FOR 54252	1,50€
16170	LEFT PINION FOR 54252	1,50€
16171	SET OF 2 WHEEL 200MM FOR 54252	20,50€
16172	PUSH BAR FOR 54252	22,50€
16173	QUICK CLAMP FOR PUSH BAR - 54252	3,00€

INDUSTRIAL PULVERIZER

53820 388,00€

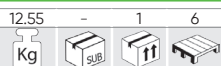

Pesticide box capacity	15L
Spray distance	8-10m
Pesticide liquid size	<50 microns (µm)
Fuel tank capacity	2L
Gasoline consumption	3,2L/h

- HIGH EFFICIENCY:
x7-10 times higher than manual sprayer

- GOOD DIFFUSION:
saves water and pesticide

- DISINFECTS WIDE COVERAGE:
through fine smoke particles

HEATER

54229 48,00€ 1.76 - 4 80 Kg SUB ff 210-160-217mm 2Kw 220V/240V 5000 MOOD 20m ² SPCC PTC 197 m ³ /h	54230 68,00€ 3.10 - 1 56 Kg SUB ff 210-160-217mm 3Kw 220V/240V 5000 MOOD 30m ² SPCC PTC 197 m ³ /h	
54231 138,00€ 4.80 - 1 27 Kg SUB ff 300-235-345mm 5Kw 380v/400v 5000 MOOD 48m ² SPCC 1,4m PTC 588 m ³ /h	54232 248,00€ 790 - 1 12 Kg SUB ff 395-307-455mm 9Kw 380v/400v 5000 MOOD 80m ² SPCC 1,4m PTC 1180 m ³ /h	

ROBOTIC LAWN MOWER

52598 1.080,00€ 1700 - 1 12 Kg SUB ff	CUTTING HEIGHT: 2,5 - 5,5CM CUTTING WIDTH: 18CM BLADE ROTATE SPEED: 3500RPM																																																				
- Autonomous lawn mower robot. - Cordless and easy to store.	APP CONNECTION 	<table border="1"> <thead> <tr> <th>REF.</th> <th>DESCRIPTION</th> <th>€</th> </tr> </thead> <tbody> <tr><td>15424</td><td>Boundary wire 150m</td><td>105,00€</td></tr> <tr><td>15425</td><td>Staples for boundary wire 150pcs</td><td>50,00€</td></tr> <tr><td>15426</td><td>Cutting blade & screws</td><td>10,00€</td></tr> <tr><td>15427</td><td>Nails for docking station</td><td>9,00€</td></tr> <tr><td>15428</td><td>Battery 22.2v, 2600mah</td><td>238,00€</td></tr> <tr><td>15429</td><td>Extension cord 5m</td><td>23,50€</td></tr> <tr><td>15430</td><td>Adapter</td><td>83,00€</td></tr> <tr><td>15431</td><td>Charging station</td><td>241,00€</td></tr> <tr><td>15432</td><td>Boundary wire connector</td><td>18,50€</td></tr> <tr><td>15433</td><td>Garage</td><td>197,00€</td></tr> <tr><td>15434</td><td>Rear wheel motor</td><td>147,00€</td></tr> <tr><td>15435</td><td>Cutting plate and protection plate</td><td>24,50€</td></tr> <tr><td>15436</td><td>Cutting motor</td><td>97,00€</td></tr> <tr><td>15437</td><td>Mother board (wifi function)</td><td>305,50€</td></tr> <tr><td>15438</td><td>Boundary wire sensor</td><td>31,00€</td></tr> <tr><td>15439</td><td>Front wheels</td><td>52,00€</td></tr> </tbody> </table>	REF.	DESCRIPTION	€	15424	Boundary wire 150m	105,00€	15425	Staples for boundary wire 150pcs	50,00€	15426	Cutting blade & screws	10,00€	15427	Nails for docking station	9,00€	15428	Battery 22.2v, 2600mah	238,00€	15429	Extension cord 5m	23,50€	15430	Adapter	83,00€	15431	Charging station	241,00€	15432	Boundary wire connector	18,50€	15433	Garage	197,00€	15434	Rear wheel motor	147,00€	15435	Cutting plate and protection plate	24,50€	15436	Cutting motor	97,00€	15437	Mother board (wifi function)	305,50€	15438	Boundary wire sensor	31,00€	15439	Front wheels	52,00€
REF.	DESCRIPTION	€																																																			
15424	Boundary wire 150m	105,00€																																																			
15425	Staples for boundary wire 150pcs	50,00€																																																			
15426	Cutting blade & screws	10,00€																																																			
15427	Nails for docking station	9,00€																																																			
15428	Battery 22.2v, 2600mah	238,00€																																																			
15429	Extension cord 5m	23,50€																																																			
15430	Adapter	83,00€																																																			
15431	Charging station	241,00€																																																			
15432	Boundary wire connector	18,50€																																																			
15433	Garage	197,00€																																																			
15434	Rear wheel motor	147,00€																																																			
15435	Cutting plate and protection plate	24,50€																																																			
15436	Cutting motor	97,00€																																																			
15437	Mother board (wifi function)	305,50€																																																			
15438	Boundary wire sensor	31,00€																																																			
15439	Front wheels	52,00€																																																			
5200 mAh Capacidad de la batería (Battery capacity) 1400m ² Superficie de corte (Mowing area) 115,44W Consumo de energía (Power consumption) AC 100-240V 50/60Hz Versión de entrada (Input Voltage) DC 15-25,5V Tensión de salida (Output Voltage) 2,5H 2H 70 dB IP X4 7,5kg 22m/min 50-35,5-24 cm																																																					

HIGH PRESSURE WASHER

This high-pressure cleaner with **1400W / 2400W** power is ideal for cleaning bicycles, vehicles and other outdoor equipment, as well as patios, terraces, greenhouses, etc.

53947 145,00€

5,80 - 1 31
Kg SUB IT

230V	1400W	MAX 105 bar	MAX AGUA WATER 50°C	5,0kg
MAX 6,8L/min	3m	5m	50Hz	IP X5

ENGINE

15398 - 10
75,00€ SUB IT

- Rated Pressure: 70 bar
- Rated flow: 5.5 L/min
- Max. water inlet pressure: 4 bar
- Dimensions: 28x25,5x44cm
- Motor type: Carbon brush

- Includes:
- 1 spray gun
- 1 high pressure hose 3m
- 1 power cord 5m



53948 324,00€

12,10 - 1 10
Kg SUB IT

230V	2400W	MAX 180 bar	MAX AGUA WATER 50°C	10,0kg
MAX 8L/min	8m	5m	50Hz	IP X5

ENGINE

15399 - 10
117,00€ SUB IT

- Rated Pressure: 120 bar
- Rated flow: 5.5 L/min
- Max. water inlet pressure: 4 bar
- Dimensions: 44x34,5x50,5cm
- Motor type: carbon brush

- Includes:
- 1 spray gun
- 1 high-pressure hose 8m
- 1 power cord 5m
- 1 turbo nozzle
- 1 transparent water connector
- 1 foam producer 750ml
- 1 patio cleaner
- 1 rim brush
- 1 fix brush



SPRAY GUN

15388 20
33,00€ IT

5M PVC HOSE

15389 20
18,50€ IT

SURFACE CLEANER 8 INCH

15390 15
43,00€ IT

FIX BRUSH

15391 50
13,50€ IT

RIM BRUSH

15392 50
17,50€ IT

TURBO NOZZLE

15393 100
12,50€ IT

FOAM CANON

15394 50
26,00€ IT

HOSE CONNECTOR

15395 50
3,50€ IT

21M RETRACTABLE ELECTRIC CABLE REEL

53585 168,00€

8,35	-	2	34
Kg	Sub	Box	Tray

53586 158,00€

5,15	-	2	30
Kg	Sub	Box	Tray

DIFFERENTIAL OVERLOAD PROTECTION



WITH WALL BRACKET

230V	1000W 3000W	H07RN-F 3G1.5mm ²	IP 44
20 m	+	1 m	



14771	0,35	30
10,50€	Kg	Box

AUTO GUIDE REWIND SYSTEM

12M RETRACTABLE ELECTRIC CABLE REEL

53584 119,00€

5,10	-	4	48
Kg	Sub	Box	Tray

53526 168,00€

8,35	-	2	34
Kg	Sub	Box	Tray



WITH WALL BRACKET

230V	1000W 3000W	H07RN-F 3G1.5mm ²	IP 44
11 m	+	1 m	

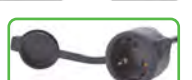

14774	0,40	10
10,50€	Kg	Box



AUTO GUIDE REWIND SYSTEM



DIFFERENTIAL OVERLOAD PROTECTION



CABLE LOCKOUT

ELECTRIC CABLE REEL EXTENSION 25m

51033 98,00€

3,86	-	2	48
Kg	Sub	Box	Tray

- Overload protection.
- Child protection.

25m	H05W-F 3x1.5 mm ² PVC	IP 20
-----	--	----------



EXTENSION CABLE

53166 10,50€

0,45	5	30	600
Kg	Sub	Box	Tray



53167 12,50€

0,65	5	20	600
Kg	Sub	Box	Tray



53168 19,00€

1,20	5	10	300
Kg	Sub	Box	Tray



VAT not included

AUTO FAN - 12V

53543 13,80€

0,75 5 20 160



x2 SPEED



DOUBLE HEADED CAR FAN

53600 13,80€

0,55 5 20 160



x2 SPEED

FANS

STANDING FAN

53189 128,00€

7,10 - 1 12



MIST FAN

54125 152,00€

8,25 - 1 14

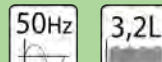
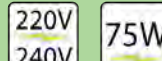

With remote control



HUMIDIFYING MODE



VENTILATION MODE

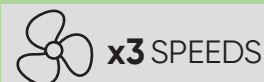

FLOOR FAN

53190 98,00€

6,10 - 1 16

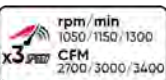
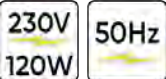

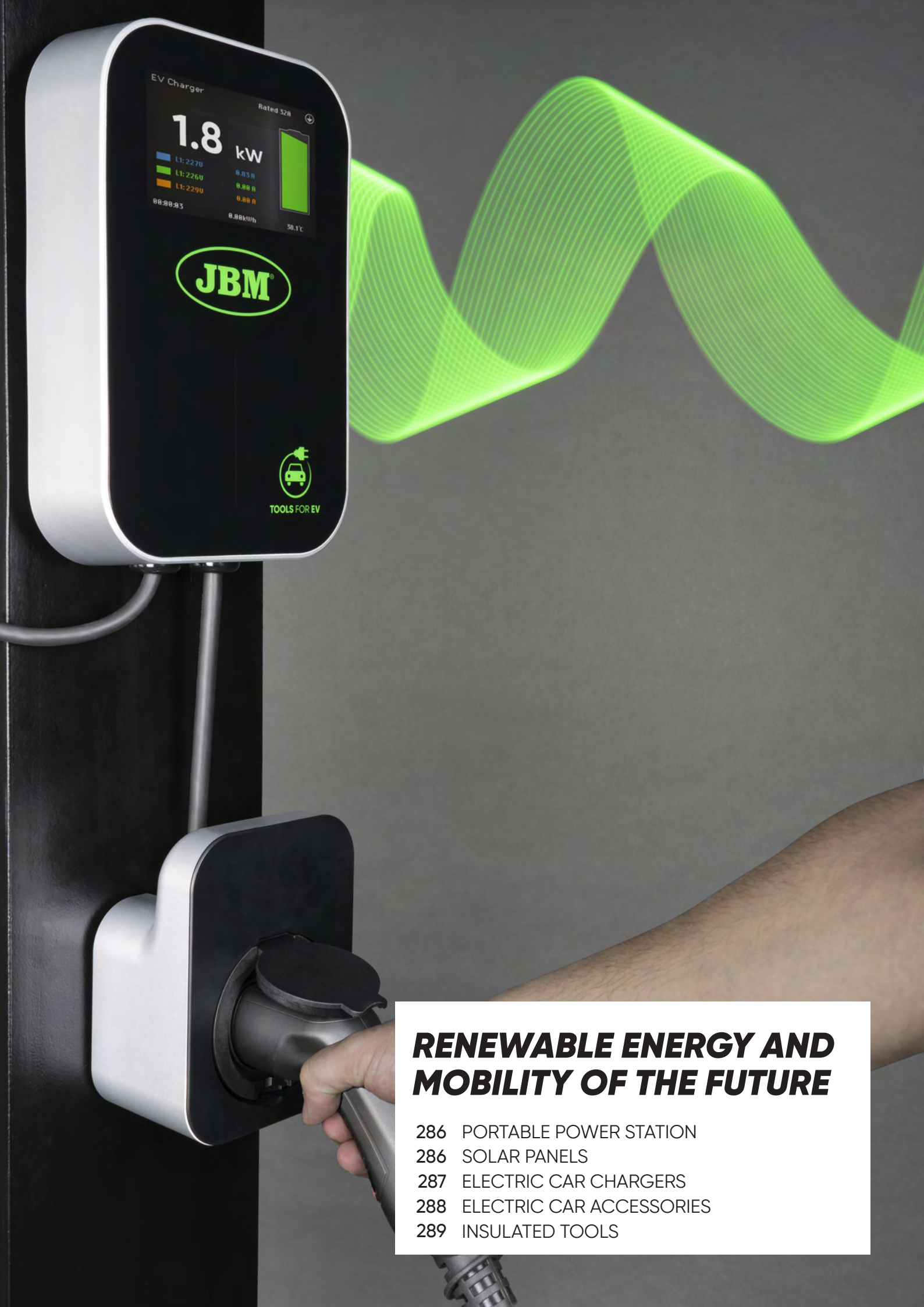

RENEWABLE ENERGY AND MOBILITY OF THE FUTURE

- 286 PORTABLE POWER STATION
- 286 SOLAR PANELS
- 287 ELECTRIC CAR CHARGERS
- 288 ELECTRIC CAR ACCESSORIES
- 289 INSULATED TOOLS

PORTABLE POWER STATION 1920WH/48V 40AH

53970

3.790,00€

The portable power station is a large-capacity portable electric generator that is recharged by solar power. But it can also be recharged from any power outlet, in the absence of sunlight.



INCLUDES:



Battery charger



Charger solar panel



Cable connector

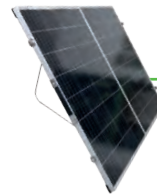

COMPATIBLE WITH 53971

34,70 - 1 13



Solida nominal de CA Rated AC output 3000W	Carga rápida Fast Charging 54V/10A 3-4H	Carga solar Solar Charging 54V/7.5A 4-5H	220VAC ± 10%
Pico de solido de CA Peak AC output 6000W	1920Wh LiFePO4	Temperatura de carga Charging temperature -10°C 60°C	Temperatura de descarga Discharging temperature 0°C 45°C
Ciclo de carga de la batería Battery life cycles >2000	50/60 Hz	2W(x2) LED	
USB-GC 5V/9V/ 12V/3A	DC(x2) 12V/10A	USB-Type-C 5V/3A 9V/ 2A 12V/1.5A	USB 5V 2.4A*2
CC-CA	MPPT	390mm	418mm
		245mm	

PORTABLE ENERGY GENERATOR

ENERGY ANYWHERE

WIDE RANGE OF APPLICATIONS



3000W +0,75h	2000W +1h	1500W +1h	1000W +1,5h	120W +12h
200W +7,5h	70W +22h	30WH +50 times	10WH +150 times	100W +15h
20W +7,5h	2200W +1h	500W +3h	500W +3h	2000W +1h

SOLAR PANEL 200W

53971

468,00€

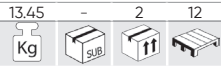

Opened:

884mm 1320mm 54mm

Closed:

884mm 659mm 54mm

200W



HIGH ENERGY



EASY TO TRANSPORT
EASY TO INSTALL

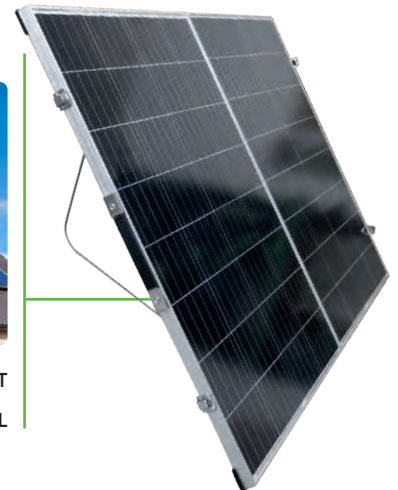

SET OF 2
MC4 1000V 30A
15448
5,50€

SOLAR PANEL

54067

599,00€

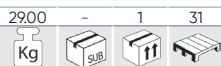

550W

MECHANICAL SPECIFICATIONS
Cell type: Monocrystalline (P-Type), 182x91mm
Number of cells: 144 (6x24)
Number of Bus Bars per photovoltaic: 10 Bus Bars
Glass: 3.2mm high transmission, anti-reflective coating

OPERATING SPECIFICATIONS
Maximum system voltage: 1000V/1500V DC
Operating temperature: -40~+85°C
Maximum series fuse rating: 25A

Output cable (connector included):
Diameter: 4.0mm²
Length: 300/400mm (customizable length).
Junction box: IP68, 3 Bypass diodes
Connector: MC4 compatible

Snow load, front side: 5400Pa
Wind load, rear side: 2400Pa
Nominal switchgear operating temperature: 45°C±2°C
Application level: Class A

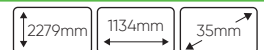
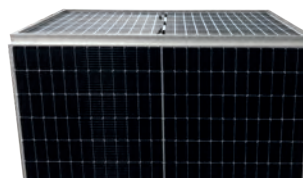
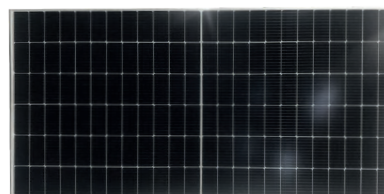

STC ELECTRICAL SPECIFICATIONS

Maximum power: 550W
Open circuit voltage: 50.2V
Maximum power voltage: 42.4V
Short circuit current: 13.78A
Maximum current rating: 12.97A
Module efficiency: 21.28%.

ELECTRICAL SPECIFICATIONS NOCT

Maximum power: 409W
Open circuit voltage: 47.1V
Maximum power voltage: 39.8V
Short circuit current: 11.13A
Maximum current rating: 10.29A

Contact us at solar@jbmcamp.com



for studies, reports, quotations and technical information.

ELECTRIC CAR CHARGERS AND ACCESSORIES



Hybrid and electric

CHARGING CABLE

54053	248,00€	2.15 Kg	1 SUB	1 IT	1
54054	268,00€	2.90 Kg	1 SUB	1 IT	102
54055	220,00€	2.15 Kg	1 SUB	1 IT	102
54056	260,00€	2.85 Kg	5 SUB	1 IT	102
54057	248,00€	2.95 Kg	5 SUB	1 IT	102
54058	348,00€	3.85 Kg	1 SUB	1 IT	102

16A	3.6 kW	Tipo 1 - 2	Monofásico Single-Phase
32A	7.5 kW	Tipo 1 - 2	Monofásico Single-Phase
16A	3.6 kW	Tipo 2 - 2	Monofásico Single-Phase
16A	11 kW	Tipo 2 - 2	Trifásico Three-Phase
32A	7.5 kW	Tipo 2 - 2	Monofásico Single-Phase
32A	22 kW	Tipo 2 - 2	Trifásico Three-Phase



IP 66	5m	-25° +55°	Tipo 1 - 2	IP 66	5m	-25° +55°	Tipo 2 - 2
-------	----	--------------	------------	-------	----	--------------	------------

PORTABLE CHARGING STATION

54059	428,00€	2.55 Kg	5 SUB	1 IT	102
16A	3.68 kW	Tipo 2			
IP 66	6m	-25° +55°			



RFID CARD

15460	5,00€	0.01 Kg	250
--------------	-------	---------	-----

16198	5,00€	0.01 Kg	1
--------------	-------	---------	---



WALL CHARGER

52600	884,00€	4.65 Kg	4 SUB	80
52902	970,00€	4.90 Kg	4 SUB	40
52903	1.100,00€	5.25 Kg	1 SUB	40
54052	1.100,00€	5.60 Kg	1 SUB	80

16A	3.6 kW	Tipo 2	Monofásico Single-Phase
32A	7.5 kW	Tipo 2	Monofásico Single-Phase
16A	11 kW	Tipo 2	Trifásico Three-Phase
32A	22 kW	Tipo 2	Trifásico Three-Phase



WALL CHARGER 22 KW, 32 A, FOR ELECTRIC CAR (THREE-PHASE)

54265	1.290,00€	5.35 Kg	1 SUB	120
32A	22 kW	Tipo 2		
			Trifásico Three-Phase	



METER FOR CHARGER 54265

16130	290,00€	0.40 Kg	15
--------------	---------	---------	----

With this gadget the 54265 charger is able to regulate its charging power by calculating the total power consumed by the rest of the home appliances in the domestic installation; preventing overloads and outages in the domestic network.



YELLOW/BLACK PLASTIC POST HIGH VOLTAGE

53940 13,20€

- Material: PVC.

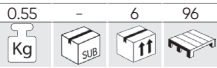

CHAIN NOT INCLUDED

For a simple, fast and mobile fencing of interior and exteriors areas.

Its contrasting colors make the chain highly visible to restrict high voltage areas.



850mm



PLASTIC S-HOOK

53942 0,50€

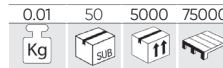

PLASTIC CHAIN

53941 6,05€

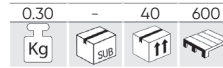

- Length: 5m
- Link: 6mm
- Color: Red / White



MARKING TAPE 200M

53987 9,50€

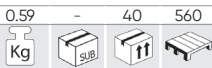

200M X 10cm



DIGITAL CLAMP METER

52382 19,50€

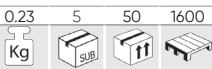

52952 74,00€

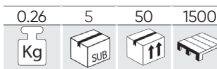

55mm

167mm

22mm

DIGITAL MULTIMETER

50942 28,00€

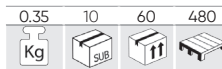

- Battery indicator.
- 9 V batteries.
- Temperature gauge.
- Temperature -40 °C to 1000 °C.

V AC
200mV, 2V, 20V, 200V, 1000V

A AC
20mA, 200mA, 20A

V DC
200mV, 2V, 20V, 200V, 750V

A DC
20mA, 200mA, 20A

Ω
200Ω, 2KΩ, 20KΩ, 200KΩ, 2MΩ, 20MΩ, 2000MΩ

F
2nF, 20nF, 200nF, 2μF, 20μF, 200μF



	52382	52952
DCB	600V	20V, 600V
ACB	600V	600V
DCA		200A
ACA	20A, 200A, 600A	200A
OHM	2KΩ, 200KΩ, 2MΩ	2000Ω

20 PIECES INSULATED TOOL SET

53154 462,00€

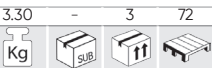

CrV 3/8" 20 PCS



420mm

80mm

33mm



20 PIECES INSULATED TOOL SET

54091 441,00€



CrV 3/8" 26 PCS



8x45mm, 10x45mm, 12x45mm, 13x45mm, 14x45mm, 16x45mm, 17x45mm, 19x45mm, 22x45mm	x1				
PHILIPS VDE 1x80mm, 2x100mm	x4				
DIAGONAL CUTTING PLIERS	x1				
200mm	x1				
72	x1				3/8"
UNIVERSAL PLIER	x1				
7x8 6mm, 8x9 9mm, 10x10 9mm, 12x12 7mm, 14x14 6mm, 17x15 6mm	x6				
200mm	x1				

50 PIECES INSULATED SCREWDRIVER SET

52521 125,00€

1.43 - 6 216

Kg SUB IT

CrV 50 PCS

D'E GS A AC 1000V IEC 60900:2004

x9	T6x100	x7	0.4x2.0x100	x5	H2.5x100
	T8x100		0.4x2.5x100		H3.0x100
x4	T9x100	x4	0.5x3.0x100	x3	H4.0x100
	T10x100		0.6x3.5x100		H5.0x100
	T15x100		0.8x4.0x100		H6.0x100
	T20x100		1.0x5.5x100		PH0x100
	T25x100		1.2x6.5x100		PH1x100
	T27x100				PH2x100
x4	4x100	x4	TRI 1x100	x3	PZ0x100
	6x100		TRI 2x100		PZ1x100
	8x100		TRI 3x100		PZ2x100
	10x100		TRI 4x100		
x2	6.3x89	x2	TORO 4x100	x3	M4x4.0x100
	8.1x89		TORO 6x100		M5x5x100
			TORO 8x100		M6x5.0x100
			TORO 10x100		
			R1x100		
			R2x100		
					89

Voltage Tester: 3.0x70 + Torx: 31x105



INSULATED SCREWDRIVER UP TO 1000V SET

52009 36,00€

0.34 10 50 1200

Kg SUB IT

D'E GS A AC 1000V IEC 60900:2004

x2	PH1x100, PH2x100
	0.4x2.5x100, 0.8x4.0x100, 1.0x5.5x100, 1.2x6.5x100



7 PIECES INSULATED SCREWDRIVERS UP TO 1.000V SET

52519 25,50€

0.14 5 10 840

Kg SUB IT

D'E GS A AC 1000V IEC 60900:2004

CrV

x2	PH00x50, PH0x50mm
	SL1.5x0.23x50, SL1.8x0.30x50, SL2.0x0.40x50, SL2.5x0.40x50, SL3.0x0.50x50mm

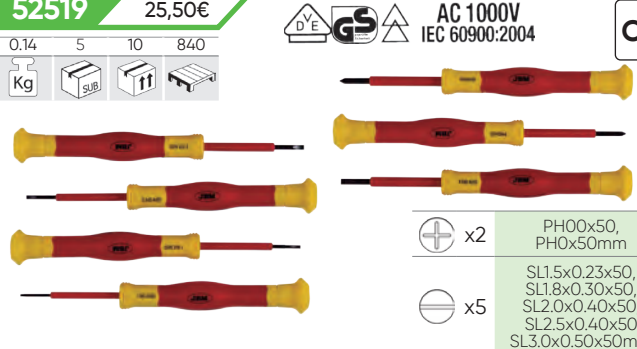

8 PIECES INSULATED SCREWDRIVER SET EVA TRAY - CARBON FINISH

15162 30,20€

0.65 - 10 240

Kg SUB IT

D'E GS A 1000V^C IEC 60900

8 PCS

VDE

x2	PH 0x75mm, PH 1x80mm, PH 2x100mm
	SL 3x75mm, SL 4x100mm, SL 5.5x125mm, SL 6.5x150mm
x5	140mm, SL 0.5 x 3.0 mm, 1000V

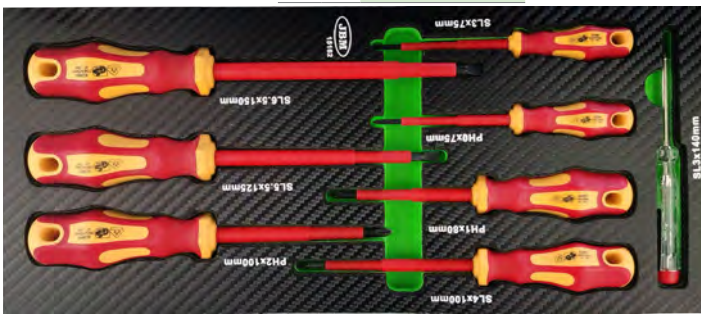

INSULATED KNIFE

53164 16,50€

0.10 6 36 1152

Kg SUB IT

D'E GS A 1000V^C IEC 60900

Certificate EN60900

180mm

50mm

CrV

53165 19,60€

0.10 6 36 1152

Kg SUB IT

D'E GS A 1000V^C IEC 60900

CrV

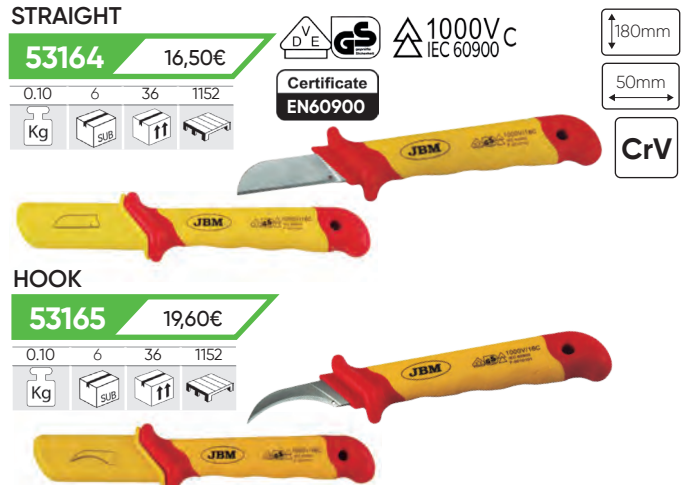

INSULATION TESTER

54114 248,00€

1.48 - 10 100

Kg SUB IT

This instrument helps you measure the electrical insulation at a determined voltage (250V, 500V or 1000V). Is an indispensable tool to evaluate the integrity of an electric circuit, specially needed to check that components and installation in the electric cars are completely isolated from the bodywork. In industrial installations, is the tool that allows you to perform periodically inspections of the insulation resistance. Measurements that are required for the DIN VDE 0105-100 (VDE 0105-100):2009-10 norm. Specially indicated for use in electric and hybrid cars.

Installation category:	2	Sampling rate:	2.5 times per second
Measurement category:	CAT III	Zero adjustment:	Automatic adjustment
Altitude:	Up to 2000 meters	Operating temperature:	0° - 40°C (32°F - 104°F), relative humidity below 80%
Display:	LCD with dual display	Storage temperature:	-10°C - 60°C (14°F - 140°F), relative humidity below 70%
Voltage:	AC: 0 - 750V	Power source:	DC9V (6x1.5V Size "AA" batteries)
Voltage DC:	0 - 1000V	Dimensions (length x width x high):	200 x 92 x 50mm
Resistance:	0 - 200Ω / 200 - 2000 Ω		
Insulation resistance:	: 0 - 200MΩ / 200 - 2000 MΩ		

TOOL TROLLEY WITH 7 DRAWERS - SPECIAL VDE

54233

1.856,00€

54234

1.856,00€

54235

1.856,00€

54236

1.856,00€

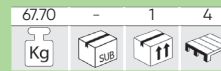
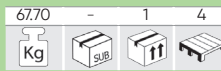
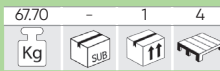
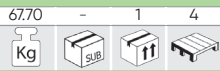

Trolley specifically designed to cover all basic needs derived from maintenance and service of hybrid and fully electric vehicles, as well as for high-tension jobs

LASER THERMOMETER -50°C TO 550°C

52162 38,00€



PVC CHAIN POST-YELLOW / BLACK

53940 13,20€



x4

PVC CHAIN - 5M YELLOW/BLACK

53941 6,05€



x4

PLASTIC CARABINER - BLACK

53942 0,50€



x8

INSULATING GLOVES FOR VOLTAGE WORK T.9

54130 58,00€



INSULATED RESCUE STICK - 45KV

54241 120,00€



EVA INSULATED TOOL MODULE VDE 26 PCS

54093 441,00€



INSULATION TESTER

54114 248,00€



INSULATING MAT CLASS 0

54129 110,00€

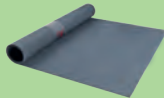

INSULATING GLOVES FOR VOLTAGE WORK

54130

58,00€

T.9

54131

58,00€

T.10

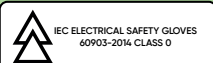
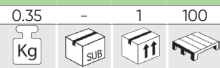

1000V AC - 1500V DC

AZC 360mm

LATEX



CLASS 0 / CLASS 0 cat.3

INSULATED RESCUE HOOK - 45KV

54241

120,00€

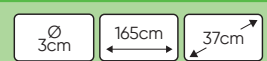

INSULATING MAT CLASS 0

54129

110,00€

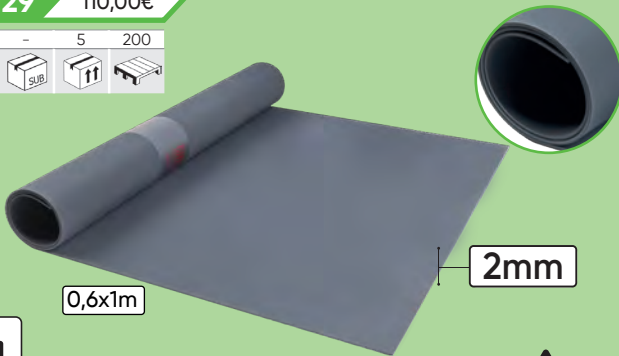
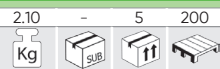

0,6x1m

2mm

1,8KG



1000V AC - 1500V DC



CLASS 0 / CLASS 0



ELECTRICAL INSULATING FACE SHIELD FOR VOLTAGE WORK

54132

190,00€

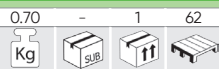

EN 166 : 2001
EN 170 : 2002
ANSI Z87.1

Anti-vaño
Anti-fog

Anti-ralladuras
Scratching Proof

Class 1

1



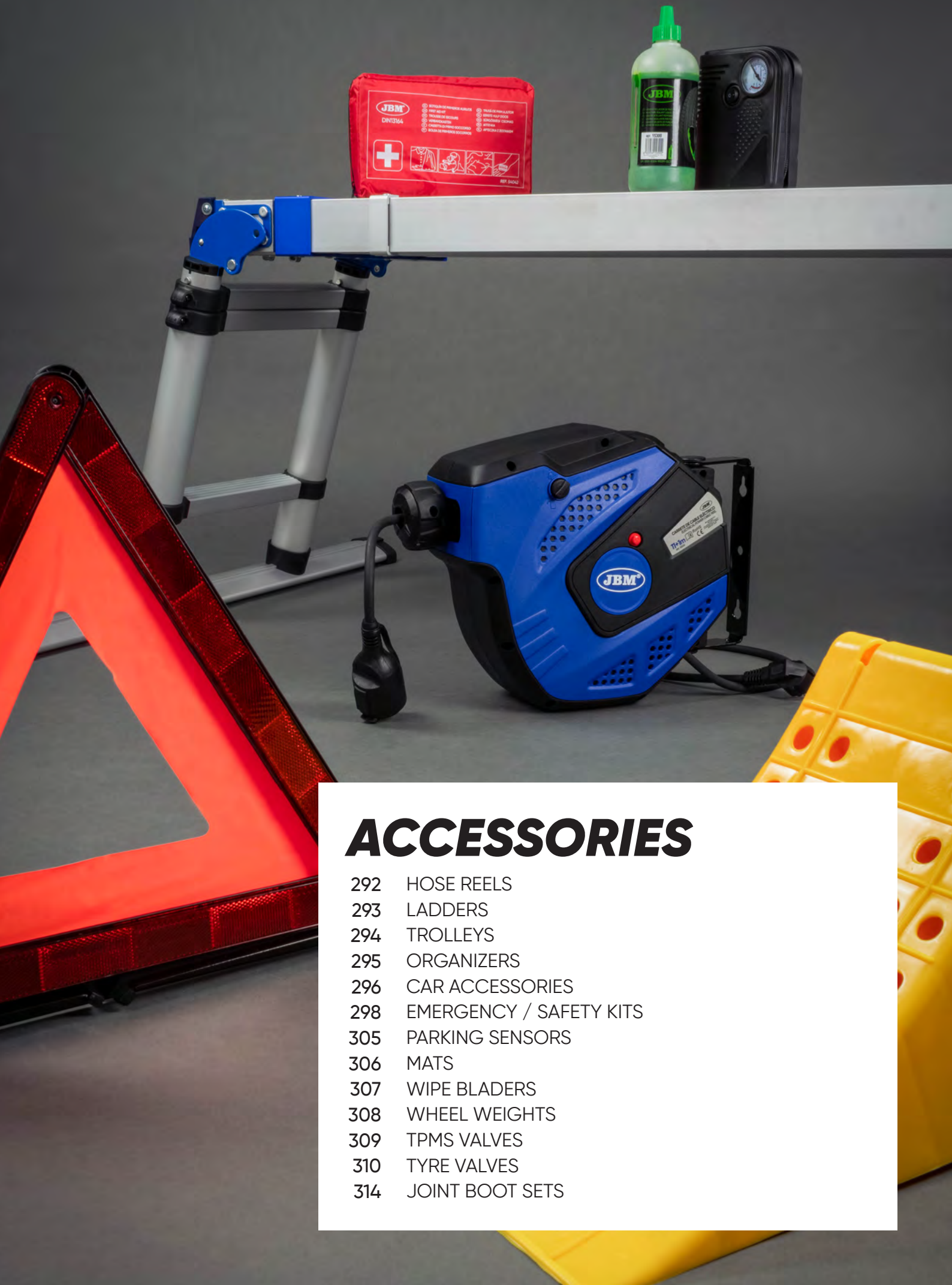

ACCESSORIES

- 292 HOSE REELS
- 293 LADDERS
- 294 TROLLEYS
- 295 ORGANIZERS
- 296 CAR ACCESSORIES
- 298 EMERGENCY / SAFETY KITS
- 305 PARKING SENSORS
- 306 MATS
- 307 WIPE BLADERS
- 308 WHEEL WEIGHTS
- 309 TPMS VALVES
- 310 TYRE VALVES
- 314 JOINT BOOT SETS

WATER HOSE REEL

53872 118,00€

7,50	-	1	21
Kg	Sub	ft	ft

- Length: 15+1,5m
- 3/4" connection
- Hose diameter: 1/2"
- Internal diameter: 11,5mm
- External diameter: 15,8mm
- Working pressure 120psi / 8bar
- Automatic hose retractable
- Hose material: PVC

15m + 1,5m    120PSI 8BAR  3/4"  PVC



1/2" WATER HOSE CONNECTOR

15153	2,50€
0,05	- 50 -
Kg	Sub ft ft

NOZZLE

15154	7,50€
0,05	- 50 -
Kg	Sub ft ft

RETRACTABLE AIR HOSE REEL

IN PAGE 146

 300 PSI 20 BAR  3/8"

53582 179,00€

10,85	-	1	14
Kg	Sub	ft	ft

22M



53583 170,00€

10,75	-	1	14
Kg	Sub	ft	ft

53532 119,00€

6,80	-	2	30
Kg	Sub	ft	ft

13M



53581 115,00€

6,70	-	2	30
Kg	Sub	ft	ft

53881 79,00€

4,50	-	4	48
Kg	Sub	ft	ft

11 M



53882 79,00€

4,50	-	4	48
Kg	Sub	ft	ft

11 M

RETRACTABLE CABLE REEL

230V  1000W 3000W  H07RN-F 3G1.5mm²  IP 44

53585 168,00€

8,35	-	2	34
Kg	Sub	ft	ft

21M



53586 158,00€

8,35	-	2	30
Kg	Sub	ft	ft

53526 168,00€

5,15	-	4	48
Kg	Sub	ft	ft

12M



53584 119,00€

5,10	-	4	48
Kg	Sub	ft	ft

RETRACTABLE OIL HOSE REEL 15M

50797 490,00€

26,60	-	1	14
Kg	Sub	ft	ft

160 BAR

Oil hose spool
Hose length: 15+1 m
Max working pressure: 2450 PSI
Inlet: 1/2" BSPT
Outlet 1/2" BSPT
Material: Steel



VAT not included

MULTI-PURPOSE LADDER

54176 188,00€



150Kg

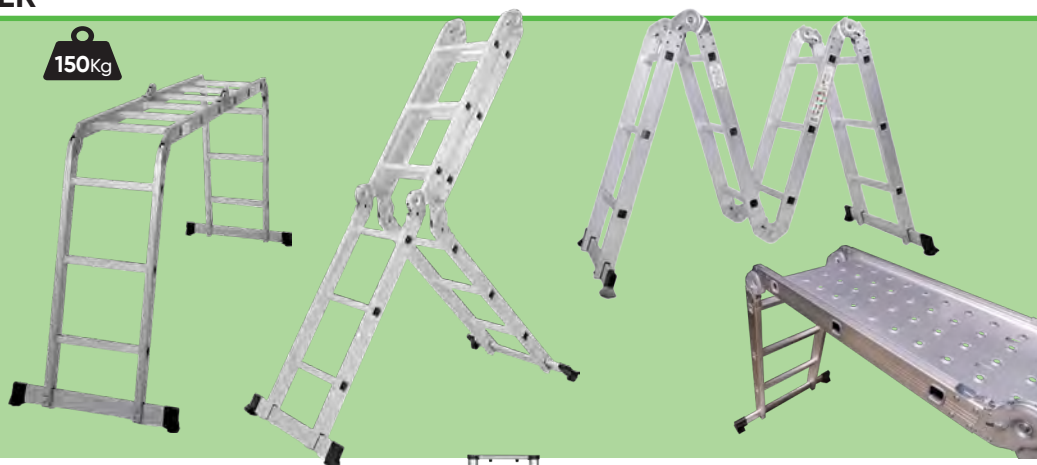

CONTAINS

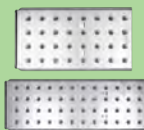

SET OF 2 PLATAFORMS

15866 32,00€



TELESCOPIC LADDER

51982 120,00€



51984 190,00€



CERTIFICATION: EN 131

51983 180,00€



51982



51983



51984

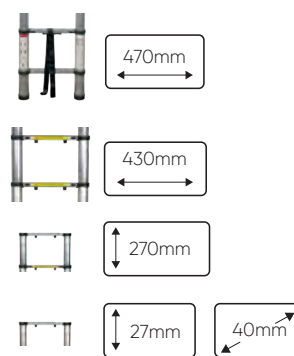

MULTI-FUNCTIONAL TELESCOPIC LADDER

52149 230,00€



- Multi-functional and light ladder.
- Block system.
- Made of aluminium and plastic.

- Height retracted: 835 mm.
- Height extended: 3800mm.
- Total height: 1900mm.

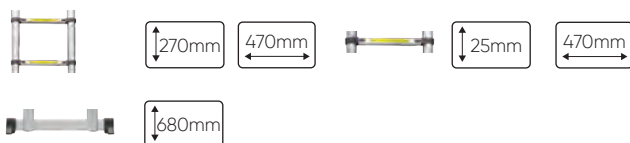

CERTIFICATION: EN 131



ALUMINIUM LADDER

50517 129,00€



- 4 STEP
- Total height: 1.30 m.
- Max. working height: 0.79 m.



50518 169,00€



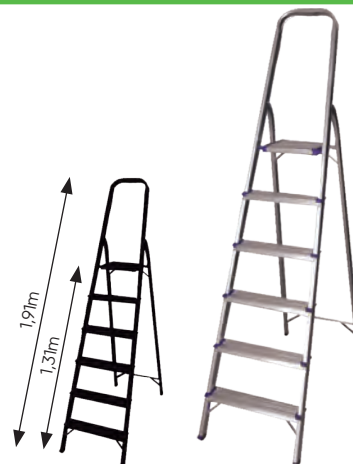

- 6 STEP
- Total height: 1.91 m.
- Max. working height: 1.31 m.



VAT not included

PRECISION SCALE

54246 104,00€ 2.27 - 10 400 Kg SUB 0°C 40°C 220V G/LB CT/OZ 5,0kg PRECISION 0.1g CONVERSION DE UNIDADES UNIT CONVERSION BATERIA ULTRA DURACION BATERIA ULTRA DURACION	Inox 304 	54247 99,00€ 2.40 - 8 400 Kg SUB 0°C 40°C 220V G/LB CT/OZ 2,0kg PRECISION 0.01g PRECISION PROTECTOR PROTECTOR CONVERSION DE UNIDADES UNIT CONVERSION BATERIA ULTRA DURACION BATERIA ULTRA DURACION	
---	--	--	---

FOLDING ALUMINIUM TROLLEY

52201 66,00€ 6.18 - 4 36 Kg SUB FOLDED 700mm 400mm 200mm	EXTENDED 1.060mm 380mm 400mm	90kg
---	---------------------------------------	-------------

COLLAPSIBLE AND EXTENSIBLE



STEEL HAND TROLLEY

52202 88,00€ 9.35 - 1 12 Kg SUB 110mm 450mm 500mm	200kg
---	--------------



PLASTIC WHEEL 3.00-4 (260x85) FOR REF. 52202 - 52661

12055 20,00€ 1.11 10 160 Kg SUB
--



STEEL PLATFORM TROLLEY

52200 88,00€ 7.80 - 1 32 Kg SUB EXTENDED 840mm 725mm 475mm	150kg
---	--------------

FOLDABLE



FOLDED 230mm 725mm 475mm



2 LOCKABLE SWIVE

WORKSHOP ACCESSORIES

24 + 2 COMPARTMENT BOX

50957 22,00€

1.13 - 12 48

Kg SUB

↑280mm ←540mm ↘80mm

- 24 compartments (8 x 5.5 cm).
- 2 compartments (15 x 7.5 cm).
- Collapsible from 26 to 5 separations.



18 + 1 COMPARTMENT BOX

50959 12,00€

0.70 - 16 128

Kg SUB

↑280mm ←360mm ↘65mm

- 18 compartments (6 x 7 cm).
- 1 compartments (35 x 7 cm).
- Collapsible from 19 to 4 separations.



5 COMPARTMENT ORGANIZER

51051 34,80€

1.61 - 12 48

Kg SUB

↑130mm ←600mm ↘165mm

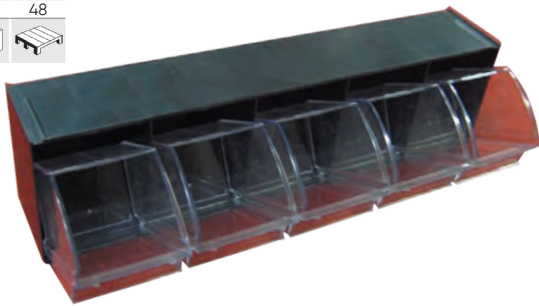

INSEPARABLE
DRAWERS

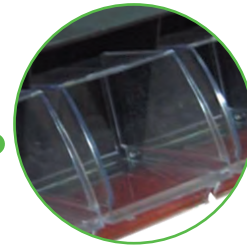

SET OF 8 STACKABLE STORAGE BINS WITH GUIDE

50960 18,30€

0.71 - 10 120

Kg SUB

↑80mm ←100mm ↘160mm

BOXES

↑80mm ←300mm ↘30mm

GUIDE



VERTICAL BIN RACK STORAGE WITH 47 COMPARTMENTS

51050 285,00€

21.95 - 1 8

Kg SUB

↑1150mm ←940mm ↘280mm

LARGE COMPARTMENTS
Total: 15
Measurements: 24 x 14.5 x 13 cm
Shelf measurements: 84 x 14 x 24 cm
Total shelves: 3

SMALL COMPARTMENTS
Total: 32
Measurements: 16 x 10 x 7.5 cm
Shelf measurements: 84 x 16 x 8 cm
Total shelves: 4



HARDSHELL ROOFTOP TENT

54180 2.400,00€

100.00	-	1	-
Kg	SUB	11	11

- Housing material: White fiberglass. Keeps the inside of the tent away from the outside temperature.
- Fabric: 600D Ripstop polyester, water, mildew and UV resistant.
- High density foam mattress with washable cover; 60mm thick.
- Telescopic aluminum ladder
- Mini light inside
- Includes installation accessories
- Interior size: 120x208cm

REF.	DESCRIPTION	Kg	SUB	11	€
15905	Set of screws and bolts	0,15	10	100	16,50€
15906	Set of installation plates	0,1	10	100	28,50€
15907	Tent interior light	0,3	10	100	12,00€
15908	Window and door brackets	0,95	10	100	14,50€
15909	Support bar				21,50€
15910	Entrance curtain				16,50€



CAR SIDE AWNING

54185 390,00€

20.00	-	1	-
Kg	SUB	11	11



An awning for vehicles is a car accessory that helps shade the vehicle from the sun as well as protecting your car or truck from the meteorological phenomena

- Car awning (1)
- Peg (4)
- Rope (2)
- 8 x 20mm stainless steel bolt (4)
- "L" bracket (2)
- 8 x 20mm square Screw (2)
- Wrench(1)



REF.	DESCRIPTION	Kg	SUB	11	€
15911	Brackets for car awning (2 pcs)	0,15	10	100	30,50€
15912	Set of screws and bolts for car awning	0,1	10	100	35,50€
15913	Pegs for car awning (2 pcs)	0,3	10	100	7,50€
15914	Bag and 2 ropes for car awning	0,95	10	100	7,50€

BABY CAR SEAT

54196

133,00€

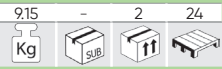

E24

ECE R44/04

GROUP 0+ / 1 / 2

Group 0+ (0-13kg) rear-facing with harness system in the most reclined position.
Group 1 (9-18kg) forward facing with harness system, and equipped with 3-point seat belt.

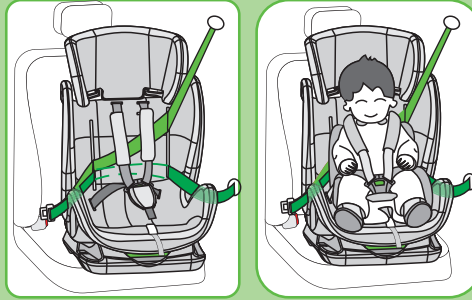

Group 2 (15-25kg) forward-facing without harness system, equipped with 3-point seat belt -6 headrest positions
-3 shoulder strap positions
-4 reclining positions



-Removable and washable fabric covers

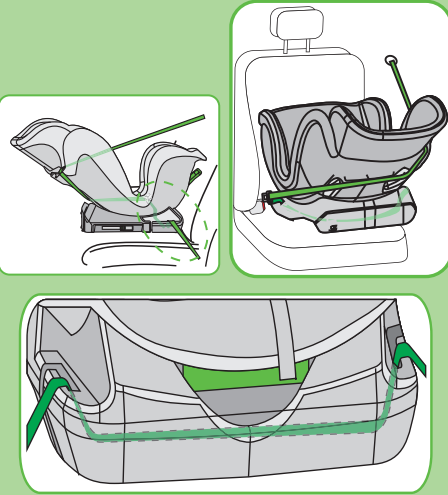

54197

118,00€

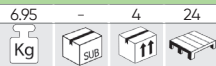

E24

ECE R44/04

GROUP 1 / 2 / 3

Group 1 (9-18 kg) forward facing with harness system and equipped with 3-point seat belt

Group 2/3 (15-36 kg) forward-facing without harness, but equipped with 3-point seat belt

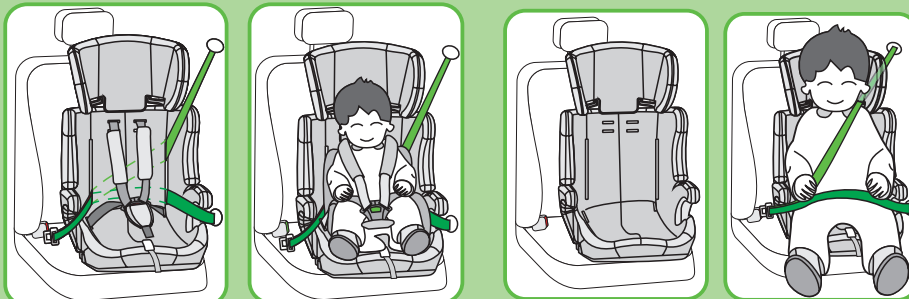

-Removable and washable fabric covers

ANTI-ABANDONMENT BABY SEAT PAD

54102

60,00€



Anti-abandonment system with integrated sensors that, placed in the car seat, allow the presence of the child on board to be detected. Pressure sensors connected to an application installed on the smartphone detect the presence of the child in the car seat and send an alarm signal if the parents leave the child in the car.

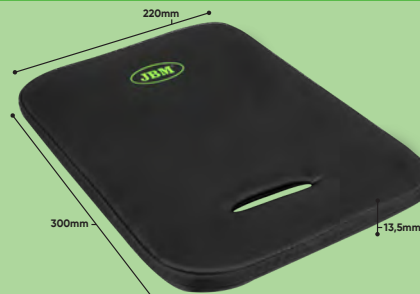

BABY CAR SEAT ALERT KEYCHAIN

15671

20,50€



TECHNICAL SPECIFICATIONS	
Dimensions:	220*300*13.5mm
Weight:	100g
Frequency band:	24-2485GHz
Transmission power:	2.51mw
Power:	Cr 3032 battery (replaceable)
Operating temperature:	-10 °C to +60 °C
Fabric:	Neoprene, Spandex, SBR
Compatible with:	iOS and Android



EMERGENCY AND SAFETY KIT

CONSULT PRICE BY AMOUNTS
PHOTOLITH AND SERIGRAPHY NOT INCLUDED



EMERGENCY KIT IN PLASTIC BOX

53540 23,00€
2,10 Kg - 9 SUB - 144



2 EMERGENCY TRIANGLES



Customizable from **50 units**.

* Double warning triangle, mandatory only in Spain.

EMERGENCY KIT BAG WITH BORDER

550 x 90 x 130mm

51692 3,25€ **51694** 3,55€ **51693** 3,55€ **51696** 3,55€

0,11 Kg - 100 SUB - 1200



EMERGENCY KIT BAG 550 x 150mm

53624 2,50€ **53621** 2,50€ **53623** 2,50€ **53622** 2,50€

0,05 Kg - 100 SUB - 3200

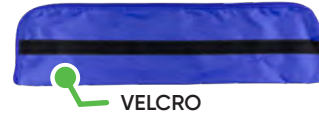

EMERGENCY KIT BAG RED WITH 1 COMPARTMENT 565 x 100 x 130mm

51681 4,50€

0,17 Kg - 100 SUB - 700



- Net material with velcro closing.

EMERGENCY KIT - PVC BAG BLACK

570 x 110 x 65mm

51691 2,40€

0,18 Kg - 100 SUB - 1600



VELCRO



BLACK EMERGENCY KIT BAG

11328 4,00€

0,12 Kg - 100 SUB - 1200



SPECIAL GREEN NYLON BAG

470 x 65 x 140mm

10945 2,30€

0,12 Kg - 100 SUB - 1600



VELCRO



EMERGENCY KIT BAG WITH 6 COMPARTMENTS 570 x 100 x 130mm

51680 2,40€

0,28 Kg - 100 SUB - 800



VELCRO



- Net material with velcro closing.
- Central division with 6 compartments.

EMERGENCY KIT BAG WITH BORDER

PUT YOUR LOGO

x1	53177	11,90€	x2	53181	11,90€
	53178	12,20€		53182	12,20€
	53179	12,20€		53183	12,70€
	53180	12,20€		53184	12,20€

* Double warning triangle, mandatory only in Spain.

EMERGENCY KIT PVC BAG

PUT YOUR LOGO

x1	53185	13,20€	x2	53186	13,20€
----	-------	--------	----	-------	--------

* Double warning triangle, mandatory only in Spain.

EMERGENCY KIT BAG WITH BORDER

PUT YOUR LOGO

	53087	11,20€		53089	11,50€
	53088	11,50€		53090	11,50€

EMERGENCY KIT BAG

PUT YOUR LOGO

	53091	10,20€		53093	10,30€
	53092	10,30€		53094	10,20€

EMERGENCY KIT

H1 (12V) H4 (12V) H7 (12V)

* Double warning triangle, mandatory only in Spain.

MK H1		MK H4	
52768	13,80€	52769	14,50€
52772	13,90€	52773	14,60€
52776	13,80€	52777	15,50€
52780	13,90€	52781	14,60€
MK H7		MK H7+H1	
52770	23,00€	52771	23,40€
52774	14,80€	52775	15,20€
52778	14,60€	52779	17,10€
52782	14,80€	52783	15,20€

WARNING TRIANGLE APPROVED

53778 4,50€

0,35	-	40	1440
Kg	Sub	ff	ff

x1 



CONFORMS TO: E4 27R-032736

52795 5,80€

0,60	1	20	980
Kg	Sub	ff	ff

x1 



CONFORMS TO: E4 27R-032738

HIGH VISIBILITY REFLECTIVE APPROVED VEST

51817 4,50€

0,13	-	100	2600
Kg	Sub	ff	ff

Marked band



CONFORMS TO: EN ISO20471:2013
+A1:2016

50654 4,00€

0,13	-	100	2600
Kg	Sub	ff	ff

Marked band



CONFORMS TO: EN ISO20471:2013
+A1:2016

50966 4,00€

0,12	-	100	2600
Kg	Sub	ff	ff

Marked band



CONFORMS TO: EN ISO20471:2013
+A1:2016

WATERPROOF PONCHO

50525 1,00€

0,05	-	250	6250
Kg	Sub	ff	ff



SPRAY CAN GUN

52493 4,50€

0,06	-	180	2160
Kg	Sub	ff	ff

- Universal useful accessory.



TIRE REPAIR SPRAY

51814 8,00€

0,30	-	12	1260
Kg	Sub	ff	ff

- To fix the tire in less than a minute without changing the wheel or disassemble.



300ml

ICE SCRAPER

51697 0,80€

0,03	-	300	6000
Kg	Sub	ff	ff



FOLDING UMBRELLA

50526 4,80€

0,20	-	100	2000
Kg	Sub	ff	ff



MINI SCISSOR 9 cm

51925 1,00€

0,01	100	1000	40000
Kg	Sub	ff	ff



EMERGENCY HAMMER WITH SUPPORT AND BELT-CUT

52259 3,75€

0,15	50	100	2400
Kg	Sub	ff	ff

135mm
20mm
75mm
Ø 160mm



CAR HOLDER FOR CELL PHONE

53443 7,55€

0,05	-	100	5000
Kg	Sub	ff	ff



COUPLING

EMERGENCY THERMAL BLANKET FOR FIRST AID KITS

15396 2,04€

0,01	-	200	-
Kg	Sub	ff	ff

CE



SAFETY BELTS

2 POINT BELT

CONFORMS TO:
E4-16R-0436213

50644 11,60€

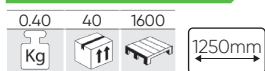

2 POINT ROLLABLE BELT

CONFORMS TO:
E4-16R-0436232

50717 21,90€

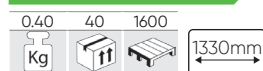

3 POINT ROLLABLE BELT

CONFORMS TO: E4-16R-0436232

51266 28,00€



PVC ZIPPER BAG

14918 0,23€



25 x 30cm



14919 0,45€



60 x 18 cm



MULTIFUNCTIONAL FOLDABLE STORAGE BOX SET

52618 29,00€



Set composed of 4 pieces:
- 37L flexible safe with lid (300mm x 490mm).
- Circular drum with lid Ø 180mm (230mm height).
- Object holder hanger without cover (90mm height x 260mm length).
- Rigid tray (175mm height x 300mm wide).



SET 3PCS MICROFIBER CLOTH

53221 4,75€

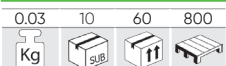

- Set of 3 microfiber chamois cloth, 100% high quality polyester material.
- Ideal for general cleaning (dusting, degreasing, polishing...)
- Great liquid absorption capacity.
- Without leaving residual threads.



IDEAL FOR GENERAL CLEANING OF ANY VEHICLE



MULTIPLE APPLICATIONS

GREAT LIQUID ABSORPTION CAPACITY



GLOVES: NITRILE, VINYL, LEATHER, COTTON...

IN PAGE 306



VAT not included

JBM

www.jbmcamp.com

301

TRUCK REFLECTIVE TAPE

51935 135,00€

1.04	-	10	280
Kg	Sub	Box	Roll

51936 135,00€

1.04	-	10	140
Kg	Sub	Box	Roll

50mm 50mm

51937 135,00€

1.02	-	10	280
Kg	Sub	Box	Roll



- Application as of 10 July 2011 according to modification of General Vehicle Regulation approved by Royal Decree 2822/1998 of 23 December 2010.
- Indivisible 50m spools.



APPROVAL:
UNECE 104R REGULATION

2 LED DYNAMO FLASHLIGHT

51573 2,50€

0.07	12	96	3456
Kg	Sub	Box	Roll



PRESENTATION
IN INDIVIDUAL BOX

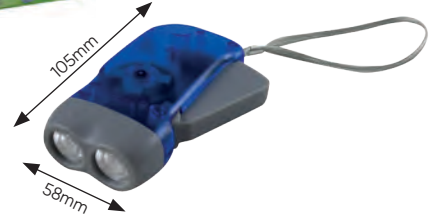

V-20 PLATE "OVERSIZED CARGO"

- Plate for loads protruding from the rear of any vehicle: truck / van / tourism / ...
- With V20 approval.

- Mandatory signaling throughout Europe for safe transport.
- Measurement: 500x500mm.

53636 22,00€

0.45	5	25	750
Kg	Sub	Box	Roll

MADE OF POLYPROPYLENE
FOR GREATER FLEXIBILITY

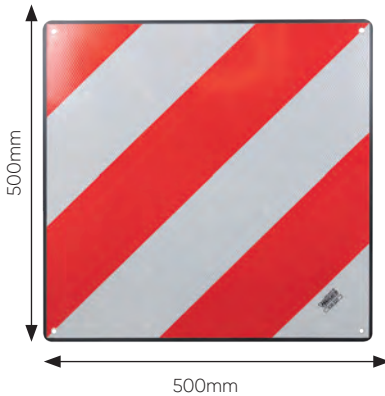

53507 24,00€

0.75	5	25	800
Kg	Sub	Box	Roll

FRONT PART MADE OF
POLYMETHYLMETHACRYLATE (PMMA) AND
BACK PART MADE OF ALUMINUM

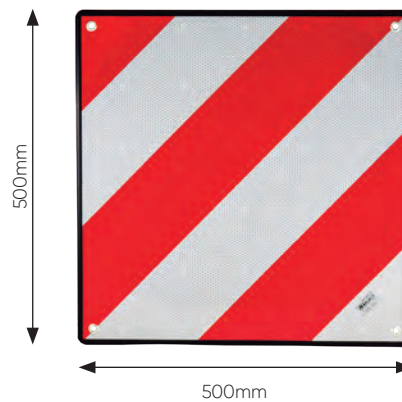

WHEEL CHOCK

53561 28,00€

1.65	-	4	72
Kg	Sub	Box	Roll



- Bright yellow wheel chock easy to see when in use.

- **Light weight:** Easy to use handle makes it easy to carry and pull out of tire.

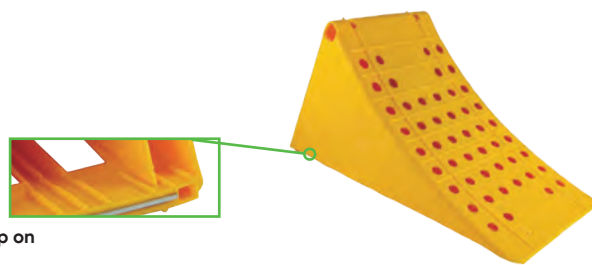
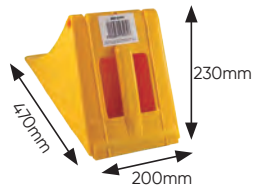

Has 1 steel strip to grip on ice and sand.



WHEEL CHOCK HOLDER

14118 26,00€

1.25	4	80
Kg	Box	Roll

WHEEL CHOCKS

53508 14,00€

0.35	4	24	288
Kg	Sub	Box	Roll

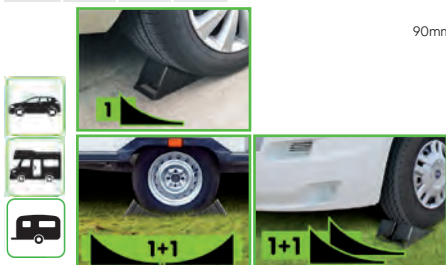

FIRST AID KIT – DIN13164: 2022

54042 13,00€

Small and easy to use first-aid kit, ideal for car and easy to transport, presented in a bag with zip and velcro closure on the back.

0,40	-	10	600
Kg	SUB	ff	

Contains:

- Adhesive tape DIN13019-A 5x2.5
- 1 Set of 14 units that contains:
 - 4 Adhesive bandages DIN 13019-E 10x6
 - 2 Finger plaster-elastic 4cmx7cm
 - 2 Finger plaster-elastic 12cmx2cm
 - 2 Plaster strips water resistant 1.9x7.2cm
 - 4 Plaster strips water resistant 2.5x7.2cm
- 1 Sterile bandage DIN 13151-K 6x8cm
- 2 Sterile bandages DIN 13151-M 8x10cm
- 1 Sterile bandage DIN 13151-G 10x12cm
- 1 First aid dressings bandage DIN 13152-BR 60x40cm
- 1 First aid dressings bandage DIN 13152-A 60x80cm
- 2 Sterile bandages DIN 61634FB6 6cmx400cm
- 3 Sterile bandages DIN 61634FB8 8cmx400cm
- 1 First aid blanket 160x210cm
- 6 Sterile wound compress 10x10cm
- 2 Triangular bandages DIN 13168-D
- 1 Scissor DIN 58279-A145 145cm
- 4 Disposable gloves DIN EN 455-1
- 2 Wet wipe for cleaning skin
- 1 Content list
- 1 First aid manual



FIRST AID KIT DIN13157: 2021

54072 38,50€

This wall-mounted first aid kit includes the necessary anchors for hanging on the wall.

1,55	-	10	120
Kg	SUB	ff	

Contains:

- 1x Adhesive plaster tape 5x25 – DIN13019-A
- 1x Set of adhesive tape bandages 10x6cm (8 pieces) – DIN13019-E
- 6x Finger plaster 4cmx6.5cm
- 6x Finger plaster 120x20mm
- 6x Finger plaster 7.2cmx1.9cm
- 12x Finger plaster 25x7.2 mm
- 1x First aid dressings bandages, Sterile Compress 6x8cm – DIN13151-K
- 3x First aid dressings bandages, Sterile Compress 8x10cm – DIN13151-M
- 1x First aid dressings bandages, Sterile Compress 10x12cm – DIN13151-G
- 1x Sterile Compress (burn dressings) 60x80cm – DIN13152-A
- 3x Sterile wound dressings (compress) 100mm x100mm 2pcs/bag – DIN58953-2
- 2x Eye pad – 55mmx75mm 1.5g
- 1x Instant Cold compress min.200cm²
- 1x First aid blanket 160cmx210cm 12 microns
- 2x Elastic bandages in compliance with the standard (gauze) 6cmx400cm – DIN61634 FB6
- 2x Elastic bandages in compliance with the standard (gauze) 8cmx400cm – DIN61634 FB8
- 2x Triangular bandages 96x96x136cm DIN13168-D
- 1x Metal Scissor 190mm – DIN58279-B190
- 2x Plastic garbage bag 300x400mm 45 microns
- 5x Non-woven Fleece 20cmX30cm min.15g/m²
- 1x Disposable gloves PVC L-AQL1.5 (set of 4 pcs) – DIN EN 455-1
- 1x Information brochure
- 2x Face masks, minimum type I, according to DIN EN 14683
- 4x Cleansing wipes for uninjured skin



FIRST AID KIT

51246 6,40€

0,20	-	50	800
Kg	SUB	ff	

Contains:

- 1 First aid pamphlet.
- 1 Scissors.
- 1 Pair of latex gloves.
- 2 Alcohol towels.
- 2 Strips.
- 25gr. of cotton.
- 1 Envelope with 5 gauzes 20x20cm.
- 1 Bandage.
- 1 Plaster roll.
- Bag size: 180x130x55mm.



LICENSE CAR PLATE HOLDER

51412 2,10€

0,09	-	100	3000
Kg	SUB	ff	

- Measurements : 53,20cm x 13,70cm.
- Marking area: 52cm x 1,60cm.

FOTOLIT AND SERIGRAPHY NOT INCLUDED



PUBLICIDAD – ADVERTISING – PUBBLICITÀ – PUBLICITATE – PUBLICIDADE – PUBLICITATE

VAT not included

JBM / www.jbmcamp.com

303

FOLDING SHOVEL

51858 15,00€

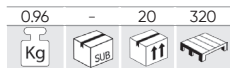

- Made with durable metal.
- Retracted: 240mm.
- Extended: 600mm.



ALUMINIUM TELESCOPIC SHOVEL

53033 21,50€

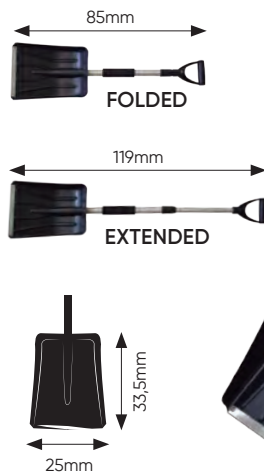
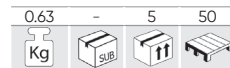

WOODEN HANDLE SHOVEL

52187 21,80€



WOODEN HANDLE SHOVEL

52251 21,80€

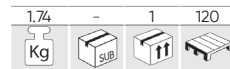

ACOUSTIC PARKING SENSOR WITH DISPLAY

51863 54,00€



- Voltage: 12V DC.
- Power: 3.6 W.
- Work temperature: - 20-70°.
- 4 nearness meters.
- Detection distance: 0.3-2.0 m.
- Detection angle: H>60°, V>60°.
- It includes nearness indicator in 2 colours.
- Black sensors: It cannot be repainted.



30M MULTI-PURPOSE ROPE

53964 9,65€



53965 25,80€



ACOUSTIC PARKING SENSOR

51973 45,00€



- Voltage: DC 12V.
- Power: 3.6 W.
- Work temperature: - 20-70°.
- 4 nearness meters.
- Detection distance: 0.3-2.0 m.
- Detection angle: H>60°, V>60°.
- Radio frequency: 315 MHz/433MHz.
- Without visual indicator.
- It includes 4 cm diameter buzzer.
- Black sensors: It cannot be repainted.



ACOUSTIC PARKING SENSOR 8 PINS

52742 64,00€



x8



- Voice alarm available.
- 4 rear sensors.
- Heavy rain-proof, all weather design.
- All spare parts are compatible.
- Paintable pins.



UNIVERSAL REVERSIBLE RUBBER MAT

50585 14,70€

2,86 - 8 208



- High quality rubber.
- Highly resistant.
- Adaptable to most vehicles.

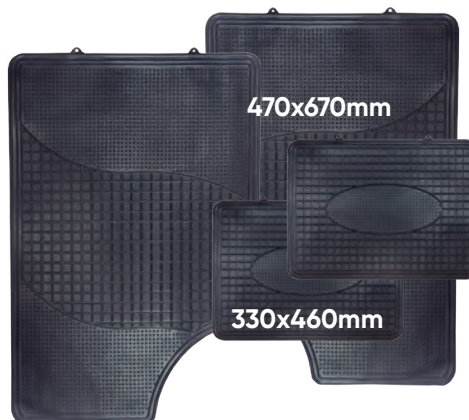

REVERSIBLE!

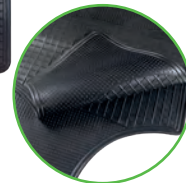

HANGING RAIL

METEXP

62,00€

6,00 - 1



UNIVERSAL RUBBER MAT

53241 9,00€

1,65 - 12 288



- High Quality Rubber.
- Very resistant.
- Adaptable to most vehicles.

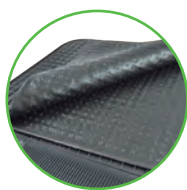

3 PCS



HANGING RAIL

METEXP

62,00€

6,00 - 1



SET UNIVERSAL CAR MAT

52530 14,00€

2,00 - 8 160



- 2 Front (390mm).
- 2 Back (365x480mm).
- Comfortable.
- Reversible with rubber.



HANGING RAIL

METEXP

62,00€

6,00 - 1



REVERSE

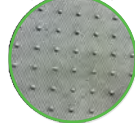

UNIVERSAL CAR MAT

COVER ALUMINIUM COLOR

52534 15,00€

1,55 - 8 160



- 2 Front (425x660mm).
- 2 Back (295x425mm).
- Comfortable.
- Reversible with rubber.



52534

52535



HANGING RAIL

METEXP

62,00€

6,00 1 25



ALL MAT

52535 16,50€

1,55 - 8 160



UNIVERSAL WIPER BLADE



EASY INSTALLATION

99%
Easy installation adapter for over 99% of vehicle applications.

100%
100% natural rubber resistant to all extreme climatic conditions.

HIGH-SPEED CLEANING POWER

38dB
The ergonomics and parts weight elimination can reduce noise to 38db.

160km/h
Aerodynamic design that allows a use up to 160km/h.

30%

Uniform pressure along the wiper blade by the steel spring for an improved visibility compared to original blades and a performance 30% higher.

45°

45° angle and precision-cut wiping edge to edge removes the smallest droplets.

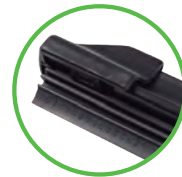

11 DIFFERENT ADAPTERS: FOR MULTIPLE APPLICATIONS



REF.	DESCRIPTION	Kg	Box	Tray	Tray	€
53745	11" 280mm	0,20	10	50	800	6,40€
53746	12" 310mm	0,20	10	50	800	6,40€
53747	13" 330mm	0,20	10	50	600	6,40€
53748	14" 350mm	0,20	10	50	800	6,60€
53749	15" 380mm	0,20	10	50	800	6,70€
53750	16" 410mm	0,20	10	50	800	6,70€
53751	17" 430mm	0,20	10	50	550	6,80€
53752	18" 460mm	0,25	10	50	800	6,95€
53753	19" 480mm	0,25	10	50	600	7,10€
53754	20" 510mm	0,25	10	50	600	7,40€
53755	21" 530mm	0,25	10	50	600	7,50€
53756	22" 560mm	0,25	10	50	700	7,90€
53757	24" 610mm	0,25	10	50	550	7,90€
53758	26" 650mm	0,30	10	50	550	8,20€
53759	28" 700mm	0,30	10	50	550	8,50€
53760	30" 750mm	0,30	10	50	500	9,60€



12 PCS

DISPLAY

JBMWBEXP 24,50€

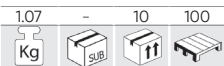

WIPER BLADES

SELF-ADHESIVE WHEEL WEIGHTS IN 45g BAR (5g - 10g - 5g - 10g - 5g - 10g)

50600 0,60€

0.05 100 400 36000

Kg SUB

ZINC



50601 0,29€

0.05 100 400 48000

Kg SUB

STEEL



SELF-ADHESIVE WHEEL WEIGHTS IN 60g BAR

52665 0,37€

0.06 100 400 37600

Kg SUB

5gr x 12 u.



- Steel.
- Long life adhesive.

52666 0,36€

0.06 100 400 37600

Kg SUB

5gr x 4 u. 10gr x 4 u.

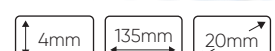

ZINC CLIP-ON WHEEL WEIGHTS UNIVERSAL RIM

REF.	g.	Kg	Sub	Box	Tray	€
50760	5g.	0.01	100	1600	80000	0,10€
50761	10g.	0.01	100	1600	102400	0,19€
50762	15g.	0.02	100	800	76800	0,29€
50763	20g.	0.02	100	800	64000	0,38€
50764	25g.	0.03	100	800	48000	0,49€
50765	30g.	0.03	100	600	50400	0,58€
50766	35g.	0.04	100	400	32000	0,68€
50767	40g.	0.04	100	400	25600	0,78€
50768	45g.	0.05	100	400	32000	0,88€
51055	50g.	0.05	100	400	2000	0,98€



ZINC CLIP-ON WHEEL WEIGHTS FRENCH RIM

REF.	g.	Kg	Sub	Box	Tray	€
50771	15g.	0.03	100	600	6600	0,29€
50774	30g.	0.03	100	1200	3300	0,57€
50776	40g.	0.04	100	400	2500	0,76€
51056	50g.	0.05	100	400	2000	0,75€

ZINC CLIP-ON WHEEL WEIGHTS ALLOY RIM

REF.	g.	Kg	Sub	Box	Tray	€
50778	5g.	0.01	100	1600	80000	0,10€
50779	10g.	0.01	100	800	76800	0,19€
50780	15g.	0.02	100	1200	60000	0,29€
50781	20g.	0.02	100	800	80000	0,38€
50782	25g.	0.03	100	800	48000	0,49€
50783	30g.	0.03	100	600	30000	0,58€
50784	35g.	0.04	100	400	32000	0,68€
50785	40g.	0.04	100	400	32000	0,78€
50786	45g.	0.05	100	400	32000	0,88€
51604	50g.	0.05	100	400	2000	0,98€



UNIVERSAL CLIP-ON WHEEL WEIGHTS FOR TRUCKS

SEGMENTATION DE 50GR

52667 0,76€

0.05 50 400 25600

Kg SUB



SEGMENTATION DE 100GR

52668 1,49€

0.10 25 200 12800

Kg SUB



SEGMENTATION DE 150GR

52669 2,22€

0.15 20 160 10240

Kg SUB



SEGMENTATION DE 200GR

52670 2,95€

0.20 10 80 5120

Kg SUB



SEGMENTATION DE 250GR

52671 3,70€

0.25 10 80 5120

Kg SUB



SEGMENTATION DE 300GR

52672 4,45€

0.30 10 80 5120

Kg SUB



WHEEL WEIGHT DISPENSER SELF-ADHESIVE - 5g STEEL BAR.

- 1000 x 5g bars of self-adhesive iron. / Wheel weights with 4 mm thickness. / Dispenser measurements: 29.5 cm x 29.5 cm.

51908 44,00€

5,60 - 4 240

Kg SUB



53256 34,00€

5,30 - 4 240

Kg SUB



With surplus retention magnet.

ASSORTED WHEEL WEIGHT CASE SELECTION BOX

53864 138,00€

10,50 - 1 71

Kg SUB

SELF-ADHESIVE WHEEL WEIGHTS
60gr: 4x10gr 4x5gr - 70u. (ref. 52666)



WHEEL WEIGHT ZINC WITH CLAMP	
UNIVERSAL TYRE SPECIAL	ALLOY TYRE SPECIAL
5g - 20 uds (ref. 50760)	5g - 20 uds (ref. 50778)
10g - 20 uds (ref. 50761)	10g - 20 uds (ref. 50779)
15g - 20 uds (ref. 50762)	15g - 20 uds (ref. 50780)
20g - 20 uds (ref. 50763)	20g - 20 uds (ref. 50781)
25g - 20 uds (ref. 50764)	25g - 20 uds (ref. 50782)
30g - 10 uds (ref. 50765)	30g - 10 uds (ref. 50783)
35g - 10 uds (ref. 50766)	35g - 10 uds (ref. 50784)
40g - 10 uds (ref. 50767)	40g - 10 uds (ref. 50785)

TIRE REPAIR KIT

54013 35,00€

1,15 5 20 200

Kg SUB

- Seals punctures up to 6mm.
- Material is non-corrosive to metal and rubber.
- Non-flammable and anti-freeze, long lasting.

PUNCTURE SEALANT LIQUID - 500ML

15300 5,00€

0,50 12 936

Kg SUB



VALVE CORE PULLERS

11960 1,50€

0,01 10 500

Kg SUB



BAG FOR KIT

15317 4,50€

0,10 500

Kg SUB

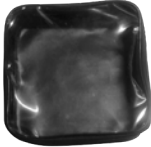

AIR COMPRESSOR PORTABLE

53150 24,00€

0,55 10 40 640

Kg SUB



AIR COMPRESSOR PORTABLE

53150 24,00€

120mm 165mm 55mm

0,55 10 40 640

Kg SUB

- Apply to cars: Family car, SUV, etc.



- DC 12V
- 100W
- 150 PSI 10 BAR
- 10A
- 16L/min
- 30mm

TPMS VALVES

12902 4,50€

0,01 4 100 1500

Kg SUB

4,25 Nm
OE 72-20-223

12920 7,80€

0,02 4 100 1500

Kg SUB

4 Nm (screw)
4 Nm (nut)

12910 4,40€

0,01 4 100 -

Kg SUB

7,5 Nm
OE 72-20-206, TPK65655

12924 4,10€

0,01 4 100 1500

Kg SUB

1,4 Nm (screw)
4,0 Nm (nut)
OE 72-20-116

53723 68,00€

0,05 - 50 6000

Kg SUB

EU-PRO HYBRID 3.5

12908 4,50€

0,01 4 100 -

Kg SUB

4,25 Nm
OE 72-20-205, TPK65654

12923 9,50€

0,01 4 100 1500

Kg SUB

8 Nm
OE TPK43211

12915 12,40€

0,04 4 100 1000

Kg SUB

8 Nm (nut)
1,4 Nm (screw)
OE 72-20-116

12925 10,70€

0,02 4 100 -

Kg SUB

TYRE REPAIR KIT

52662

36,50€

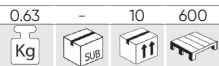

- 1 x Perforation tool
- 1 x Wicks insertion tool
- 1 x Tool to inflate tires
- 4 x Compressed air bottles 16gr
- 1 x Cutter
- 10 x Wicks
- 1 x Tire valve core

52663

30,00€

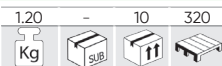

- 1 x Wicks insertion tool
- 1 x Tip for wicks insertion tool
- 1 x Perforation tool
- 1 x Cutter
- 20 x Wicks
- 1 x Lubricant

WICK REPLACEMENT FOR REF. 52662/52663

12973

1,00€

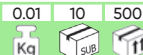

x5



PERFORATION tool FOR REF. 52663

13806

10,50€

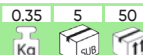

WICK INSERTION tool FOR REF. 52663

13805

10,50€



DOUBLE HEAD VALVE CORE REMOVER

52653

3,00€



- To install and remove valves core.

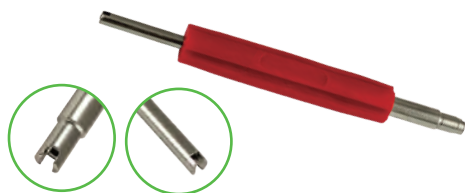

4 WAY VALVE TOOL

52652

2,80€

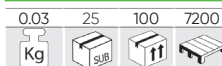

WHEEL WEIGHT PLIERS

51355

19,00€



- Extracts easily and replaces the counterweight.
- Cuts and folds easily.
- Made of heat reinforced steel.
- Includes ergonomic handle.



VALVE CAPS AND VALVE CORE SET

52673

18,00€



ALSO AVAILABLE:



11900

3,50€

Aluminium caps for valve tire. 4 units / blister.



11901

2,50€

Green plastic caps for valve tire. 4 units / blister.



11902

3,50€

Black plastic caps for valve tire. 4 units / blister.

CONTENTS:

11903

5,00€

16 units aluminium caps for valve tire.

11905

1,50€

50 units black plastic caps for valve tire.

11907

11,00€

50 units valve core set high pressure.

11904

2,00€

50 units green plastic caps for valve tire.

11906

8,50€

50 units valve core set.

11960

1,50€

Core pullers.

TPMS VALVES REPAIRING TOOL BOX

52818

148,00€



- Set of multiple tools specially designed for an easy assembly and disassembly of the TPMS sensors.

- 2-14 NM
- 0,5-3,5 NM
- 2x Ø 11, 12mm
- 3x T10, T15, T20
- 150mm
- 2mm
- 0,25 Nm
- 0,45 Nm



TYRE VALVES

TR413

51741 0,50€

0.01	100	1000	48000
Kg	sub	ff	ff



TR414

51742 0,50€

0.01	100	1000	48000
Kg	sub	ff	ff



TR418

51743 0,55€

0.02	100	1000	48000
Kg	sub	ff	ff



x100

VALVE INSERTION TOOL

- To mount valves in vehicle tires.

METAL

52649 5,00€

3.20	10	50	2250
Kg	sub	ff	ff



PLASTIC

52650 5,00€

0.15	10	100	2400
Kg	sub	ff	ff



TYRE PATCH ROLLER

52842 11,00€

0.15	10	100	1500
Kg	sub	ff	ff

38mm



3 PCS WHEEL RIM PROTECTION SET

53419 9,70€

0.10	10	100	600
Kg	sub	ff	ff

3 PCS



WAY WHEEL NUT WRENCH

51661 12,00€

1.17	5	20	480
Kg	sub	ff	ff

355mm 17, 19, 21mm

1/2"



52881 17,00€

1.40	-	10	420
Kg	sub	ff	ff

400mm 17, 19, 21, 22mm

1/2"

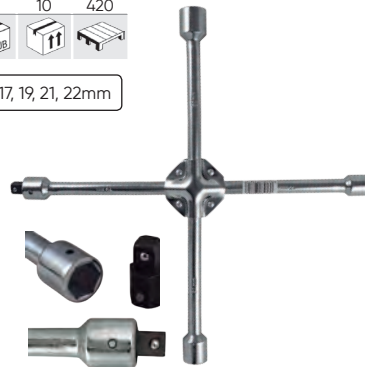

52880 42,00€

3.75	-	5	100
Kg	sub	ff	ff

700mm 24, 27, 32mm

3/4"



TELESCOPIC WHEEL WRENCH WITH REVERSIBLE SOCKETS

51416 12,00€

1.05	10	20	600
Kg	sub	ff	ff

330-490mm

1/2"



CHROME

21mm / 23mm

17mm / 19mm



PLASTIC DUCK HEAD FOR TIRE CHANGERS

52657 37,50€

0.18	5	20	800
Kg	Sub	ff	ff



52658 39,70€

0.17	-	20	800
Kg	Sub	ff	ff



52659 39,70€

0.26	-	20	1920
Kg	Sub	ff	ff



TYRE BEAD BREAK PLASTIC CLAMP

52655 39,70€

0.39	-	25	1500
Kg	Sub	ff	ff

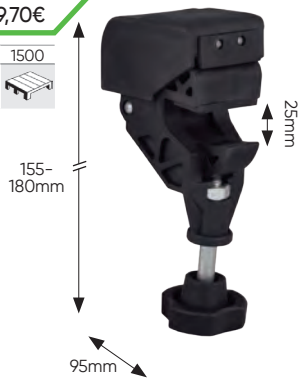

TYRE LEVER

51362 3,00€

0.15	5	60	500
Kg	Sub	ff	ff

51358 7,50€

0.47	6	24	1008
Kg	Sub	ff	ff

51359 9,00€

0.90	6	30	1440
Kg	Sub	ff	ff



52656 39,50€

0.40	5	20	1920
Kg	Sub	ff	ff



TRUCK TYRE LEVER

52664 168,00€

12.30	-	1	15
Kg	Sub	ff	ff



MANUAL TYRE CHANGER

53605 141,00€

16.00	-	1	21
Kg	Sub	ff	ff

950mm

- Tyre capacity: All tyres from 8 IN. to light truck tyres (7- 1/2 IN. x 16 IN.)
- Flotation tyres: Up to 12.5L 16
- Includes: 1 Bead breaker handle 37 IN. Long Mount / Demount Tool



TYRE DOLLY WITH CASTERS

54198 59,00€

4.25	-	1	35
Kg	Sub	ff	ff



66x66x11cm

- Four 3" swivel casters (one lockable).
- Color: black
- Side handle for easy transport
- Load capacity: 136 kg
- Dimensions: 66x66x11 cm
- Weight: 3.4 kg
- Wheel material: steel + TPR
- Body material: plastic

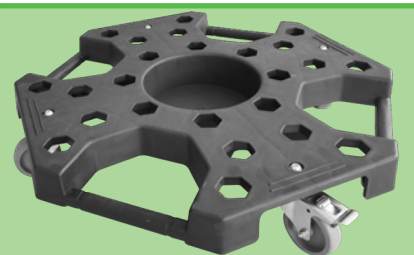

MANUAL TYRE CHANGER

54136 107,00€

5.25	-	2	144
Kg	Sub	ff	ff

257mm 162mm 110mm

FOR / PARA



TYRE CARTS

52660	126,00€	52661	290,00€
7,88	-	1	18
Kg	sub	ff	sub

HIGH CAPACITY

AIR TYRE BEAD SEATER BLASTER TOOL

52552	128,00€		
12,00	-	1	15
Kg	sub	ff	sub

18L

-20°C
40°C

6-8 BAR
87-116 PSI

MAX.
10 BAR
145 PSI

REPLACEMENT NOZZLE FOR REF. 52552

13741	21,00€		
0,35	-	32	-
Kg	sub	ff	sub

CV BOOT EAR CLAMP

11891	0,50€	11890	0,55€
0,01	100	5000	90000
Kg	sub	ff	sub

x100

15-45mm

50-125mm

x100

2 PIECE CV BOOT EAR CLAMP SET

52633	1,00€		
0,02	100	800	14400
Kg	sub	ff	sub

50-125mm

15-45mm

USE WITH PLIERS REF. 52619.

CENTERING RINGS

REF.	Kg	sub	ff	sub	€
52645	0,02	50	1.000	38.000	0,55€
52646	0,01	50	1.000	80.000	0,50€
53037	0,01	50	1.000	-	0,50€
53038	0,01	50	1.000	35.000	0,50€
53039	0,02	50	1.000	35.000	0,50€
53040	0,01	50	1.000	35.000	0,50€

52645

22mm

Ø25mm

2,5mm

52646

12mm

Ø25mm

2mm

53037

12mm

Ø23mm

2,5mm

53038

12mm

Ø21mm

2,5mm

53039

19mm

Ø25mm

2,5mm

53040

9mm

Ø25mm

2,5mm

FLEX COUPLERS INNERBRAID LINER



REF.	DESCRIPTION	Kg	sub	ff	sub	€
51706	Ø 25mmL x 300mmL	0,35	25	1.500		22,80€
51707	Ø 45mmL x 100mmL	0,27	25	1.200		9,05€
51708	Ø 45mmL x 150mmL	0,38	25	-		14,20€
51709	Ø 45mmL x 200mmL	0,50	25	-		14,70€
51710	Ø 45mmL x 250mmL	0,65	25	600		17,80€
51711	Ø 45mmL x 300mmL	0,71	25	-		21,20€
51712	Ø 50mmL x 100mmL	0,30	25	-		8,65€
51713	Ø 50mmL x 150mmL	0,45	25	-		13,10€
51714	Ø 50mmL x 200mmL	0,56	25	-		15,80€
51715	Ø 50mmL x 250mmL	0,70	25	-		20,30€
51716	Ø 50mmL x 300mmL	0,83	25	450		23,60€
51717	Ø 55mmL x 100mmL	0,35	25	-		11,20€
51718	Ø 55mmL x 150mmL	0,50	25	-		14,80€
51719	Ø 55mmL x 200mmL	0,65	25	-		22,00€
51720	Ø 55mmL x 250mmL	0,85	25	350		23,50€
51721	Ø 55mmL x 300mmL	1,00	25	375		25,00€
51722	Ø 60mmL x 100mmL	0,36	25	-		13,10€
51723	Ø 60mmL x 150mmL	0,50	25	-		18,70€
51724	Ø 60mmL x 200mmL	0,66	25	-		24,40€
51725	Ø 60mmL x 250mmL	0,83	25	-		28,30€
51726	Ø 60mmL x 300mmL	0,96	25	250		31,40€
51727	Ø 60mmL x 400mmL	1,62	25	200		49,00€

CV JOINT BOOT SET

CAR

51705

8,45€

0.23	-	20	400
Kg	sub	ff	ff



VAN

51703

10,50€

0.28	-	20	320
Kg	sub	ff	ff



REPLACEMENT FOR REF. 51703

13739

5,50€

0.15	100	1600
Kg	ff	ff



REPLACEMENT FOR REF. 51705

13738

3,50€

0.08	150	2400
Kg	ff	ff



UNIVERSAL STEERING JOINT BOOT SET

52644

8,80€

0.19	-	20	400
Kg	sub	ff	ff

NEOPRENE



UNIVERSAL STEERING JOINT BOOT GREASE

13880

1,50€

0.01	600	21000
Kg	ff	ff



REPLACEMENT FOR REF. 52644

13740

5,50€

0.10	72	-
Kg	ff	ff



CV BOOT TOOL

52829

19,00€

0.45	-	10	200
Kg	sub	ff	ff

EXTERIOR

INSIDE

Ø 10cm

Ø 9,5cm

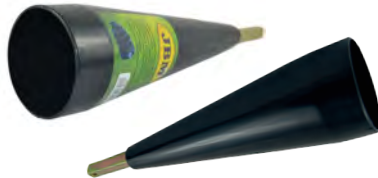

PNEUMATIC CV JOINT EXPANDER

51861

199,00€

4.00	-	2	32
Kg	sub	ff	ff

- Material: Aluminum.
- Aperture 20 to 100mm.

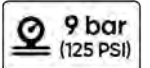

UNIVERSAL CV BOOT SET

SERIE124

710,00€

22.15	-	-	20
Kg	sub	ff	ff

CV JOINT GREASE

13879

1,38€

0.09	-	150	5250
Kg	sub	ff	ff



51861 x1

52633 x100

13738 x100

13879 x100

UNIVERSAL STRETCH BOOT SET

53693

521,00€

19.80	-	1	20
Kg	sub	ff	ff



x100

13738



x100

52633



x100

13879

UNIVERSAL STRETCH BOOT SET FOR VAN

53698

717,00€

19.80	-	1	24
Kg	sub	ff	ff



x100

13739



x100

52633



x100

13880

UNIVERSAL STEERING RACK BOOT SET

53695

504,00€

11.25	-	1	24
Kg	sub	ff	ff



x80

13740



x80

52633



x80

13880

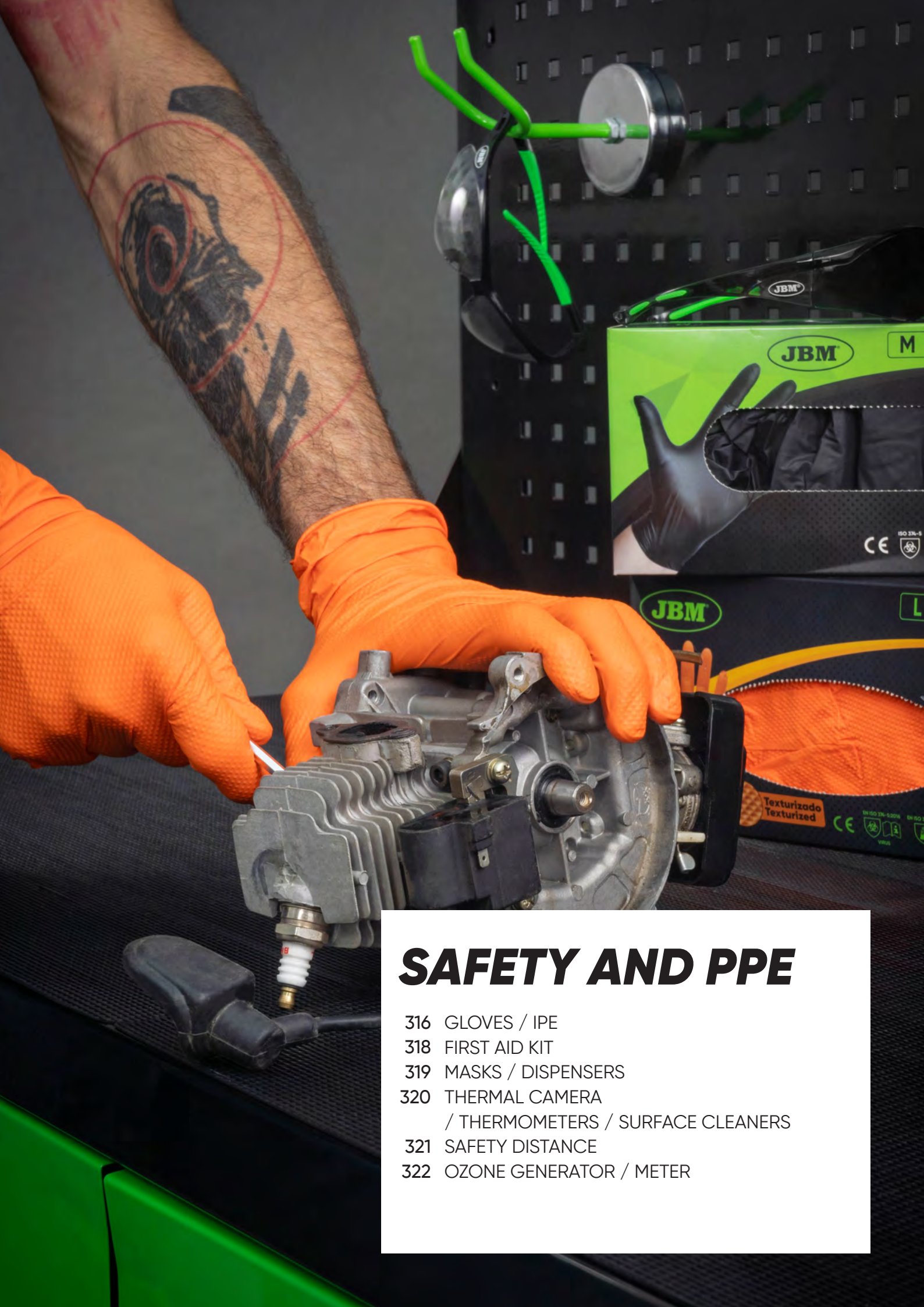

SAFETY AND PPE

- 316 GLOVES / IPE
- 318 FIRST AID KIT
- 319 MASKS / DISPENSERS
- 320 THERMAL CAMERA
/ THERMOMETERS / SURFACE CLEANERS
- 321 SAFETY DISTANCE
- 322 OZONE GENERATOR / METER

PALM POLYURETHANE COATED GLOVES

REF. 1,54€

0,05	12	144	3456
Kg	Sub	ff	ff

51640N T.8

51642N T.9

51636N T.10

51638N T.11



EN 388
3131

CE
CAT - II

PALM NITRILE COATED GLOVES

REF. 1,74€

0,04	12	144	3456
Kg	Sub	ff	ff

51633 T.8

51634 T.9

51632N T.10

51398N T.11



EN 388
3121X

CE
CAT - II

COTTON GLOVES WITH PVC DOTS

51785 0,75€

0,04	12	300	3600
Kg	Sub	ff	ff

REFORCED PALM



CE

COTTON GLOVES

51745 0,70€

0,05	12	144	4320
Kg	Sub	ff	ff



CE

LEATHER AND TEXTILE GLOVES

52310 3,65€

0,20	12	120	1920
Kg	Sub	ff	ff



CE

LEATHER GLOVES

52738 5,00€

0,10	12	144	2304
Kg	Sub	ff	ff

T. 9



CE
EN388: 16
2121X

52739 5,00€

0,12	12	144	2304
Kg	Sub	ff	ff

T. 10



CE

WORK GLOVES

REF. 19,00€

0,15	12	60	2040
Kg	Sub	ff	ff

54188 T.8

54189 T.9

54190 T.10

54191 T.11



EN 388
3131

CE

THERMAL WORK GLOVES

REF. 8,90€

0,15	12	144	3456
Kg	Sub	ff	ff

54192 T.8

54193 T.9

54194 T.10

54195 T.11



EN 511
EN 388
3131

CE

Automocion
Industria
Tecnico
Anti-choque
Anti-corte

CUT RESISTANT GLOVES TACTILE FEATURE

52570 2,60€

0,03	12	144	3456
Kg	Sub	ff	ff

T. 8

EN 388
3131X

52571 2,60€

0,03	12	144	2592
Kg	Sub	ff	ff

T. 9

EN 388
3131X

52572 2,60€

0,03	12	144	2592
Kg	Sub	ff	ff

T. 10

EN 388
4131

52573 2,60€

0,04	12	144	2592
Kg	Sub	ff	ff

T. 11

EN 388
4131

FOR TOUCH SCREEN





CE

Info icon

Touch icon

NITRILE GLOVES

JBM	REF.	DÉSCRIPT ION	Kg	11	11	€	
	3.5 MIL						
	54294	S	0,40	100	10	500	8,80€
53984	M	0,50	100	10	400	8,80€	
53985	L	0,50	100	10	400	8,80€	
53986	XL	0,55	100	10	400	8,80€	



JBM	REF.	DESCRIPTION	Kg	11	11	€	
	3.5 MIL						
	54155	M	0,50	100	10	570	8,80€
54156	L	0,50	100	10	570	8,80€	
54157	XL	0,50	100	10	570	8,80€	



EN 420:
2003 + AT: 2009



EN ISO
374-5: 2016

JBM	REF.	DESCRIPTION	Kg	11	11	€	
	5.0 MIL						
	54151	M	0,62	100	10	510	10,90€
54152	L	0,62	100	10	510	10,90€	
54153	XL	0,67	100	10	510	10,90€	

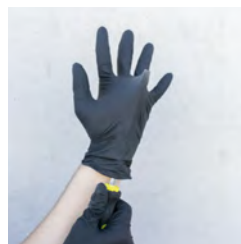

DISPOSABLE NITRILE DIAMOND GRIP GLOVES

JBM	REF.	DESCRIPTION	Kg	11	11	€	
	7.0 MIL						
	53551	M	0,90	100	10	300	18,95€
53552	L	1	100	10	300	18,95€	
53553	XL	1	90	10	300	18,95€	



**100
PZ**



EN ISO
374-5: 2016

EN 420:
2003 + AT: 2009

JBM	REF.	DESCRIPTION	Kg	11	11	€	
	7.0 MIL						
	54177	M	0,90	100	10	300	18,95€
54178	L	0,90	100	10	300	18,95€	
54179	XL	0,90	90	10	300	18,95€	



CE

EN ISO
374-1:2016/Type B

JKPT

HIGH VISIBILIY REFLECTIVE VEST

51817 4,50€

0,13 - 100 2600

Kg SUB 11 11

50966 4,00€

0,12 - 100 2600

Kg SUB 11 11

50654 4,00€

0,13 - 100 2600

Kg SUB 11 11

Marked band

COMPLIES WITH:
EN ISO20471:2013



VAT not included

ANTIFOG SPORT PROTECTIVE GOOGLES

53598 3,95€

CONFORMS TO:
EN166:2002-04 / EN166:2003-01

53596 3,65€

53597 3,70€



IN 12 UNITS
DISPLAY
CASE

0,01	12	144	2016
Kg	Sub	ft	ft



53596, 53597,
53598



53597

ANTIFOG SAFETY GOGGLES

53785 4,80€

CONFORMS TO: EN166:2002-04

0,05	14	112	896
Kg	Sub	ft	ft

- Protection against liquids and bacterias.
- Adjustable elastic band.
- Anti-fog treatment on lens.



Built-in valves for
better ventilation.



EAR MUFFS

52430 10,90€

0,34	6	24	96
Kg	Sub	ft	ft



PVC



ABS

CONFORMS TO: EN352 - 1:2003

FIRST AID KIT - DIN13164

54042 13,00€

Small and easy to use first-aid kit, ideal for car and easy to transport, presented in a bag with zip and velcro closure on the back.

0,40	-	10	320
Kg	Sub	ft	ft

Contains:

- Adhesive tape DIN13019-A 5x2.5
- 1 Set of 14 units that contains:
 - 4 Adhesive bandages DIN 13019-E 10x6
 - 2 Finger plaster-elastic 4cmx7cm
 - 2 Finger plaster-elastic 12cmx2cm
 - 2 Plaster strips water resistant 1.9x7.2cm
 - 4 Plaster strips water resistant 2.5x7.2cm
 - 1 Sterile bandage DIN 13151-K

- 6x8cm
- 2 Sterile bandages DIN 13151-M 8x10cm
- 1 Sterile bandage DIN 13151-G 10x12cm
- 1 First aid dressings bandage DIN 13152-BR 60x40cm
- 1 First aid dressings bandage DIN 13152-A 60x80cm
- 2 Sterile bandages DIN 61634FB6 6cmx400cm
- 3 Sterile bandages DIN 61634FB8

- 8cmx400cm
- 1 First aid blanket 160x210cm
- 6 Sterile wound compress 10x10cm
- 2 Triangular bandages DIN 13168-D
- 1 Scissor DIN 58279-A145 145cm
- 4 Disposable gloves DIN EN 455-1
- 2 Wet wipe for cleaning skin
- 1 Content list
- 1 First aid manual



FIRST AID KIT DIN13157: 2021

54072 38,50€

This wall-mounted first aid kit includes the necessary anchors for hanging on the wall.

1,55	-	10	120
Kg	Sub	ft	ft

Contains:

- 1x Adhesive plaster tape 5x25 - DIN13019-A
- 1x Set of adhesive tape bandages 10x6cm (8 pieces) - DIN13019-E
- 6x Finger plaster 4cmx6,5cm
- 6x Finger plaster 120x20mm
- 6x Finger plaster 7.2cmx1.9cm
- 12x Finger plaster 25x72 mm
- 1x First aid dressings bandages, Sterile Compress 6x8cm - DIN13151-K
- 3x First aid dressings bandages, Sterile Compress 8x10cm - DIN13151-M
- 1x First aid dressings bandages, Sterile Compress 10x12cm - DIN13151-G
- 1x Sterile Compress (burn dressings) 60x80cm - DIN13152-A
- 3x Sterile wound dressings (compress) 100mm x100mm 2pcs/bag - DIN58953-2
- 2x Eye pad - 55mmx75mm 1.5g

- 1x Instant Cold compress min.200cm²
- 1x First aid blanket 160cmx210cm 12 microns
- 2x Elastic bandages in compliance with the standard (gauze) 6cmx400cm - DIN61634 FB6
- 2x Elastic bandages in compliance with the standard (gauze) 8cmx400cm - DIN61634 FB8
- 2x Triangular bandages 96x96x136cm DIN13168-D
- 1x Metal Scissor 190mm - DIN58279-B190
- 2x Plastic garbage bag 300x400mm 45 microns
- 5x Non-woven Fleece 20cmx30cm min.15g/m²
- 1x Disposable gloves PVC L-AQL1.5 (set of 4 pcs) - DIN EN 455-1
- 1x Information brochure
- 2x Face masks, minimum type I, according to DIN EN 14683
- 4x Cleansing wipes for uninjured skin



FIRST AID KIT

51246 6,40€

0,20	-	50	800
Kg	Sub	ft	ft

- Contains:
- 1 First aid pamphlet.
- 1 Scissors.
- 1 Pair of latex gloves.
- 2 Alcohol towels.
- 2 Strips.

- 25gr. of cotton.
- 1 Envelope with 5 gauzes 20x20cm.
- 1 Bandage.
- 1 Plaster roll.
- Bag size: 180x130x55mm.



FILTERING PROTECTIVE FACE MASK

FFP2

- With a nose clip to shape the half mask at the nose.
- Arched design for smoother breathing.
- Bands made of rubber for an easier attach.

53787 0,98€

0,01	10	800	6400
Kg	Sub	Box	Tray



Penetration of the filter materia

≤ 6%

Total leakage:

≤ 11%

Respiratory resistance max.

30l/min (inhalation): ≤ 0.70 mbar
95l/min (inhalation): ≤ 2.4 mbar
160l/min (exhalation): ≤ 3 mbar

Approved according to EU regulation 2016/42
Complies with EN149:2001+A1:2009 regulations

MASK WITH VALVE

53844 2,80€

0,02	3	360	1440
Kg	Sub	Box	Tray



Served in boxes of 3 units

Approved according to EU regulation 2016/42
Complies with EN 149:2001 standard

FFP2

53946 0,83€

53961 0,98€

53960 0,98€

537870 0,98€

53959 0,98€



Approved according to EU regulation 2016/42
Complies with EN149:2001+A1:2009 regulations

Penetration of the filter materia

≤ 6%

Total leakage:

≤ 11%

Respiratory resistance max.

30l/min (inhalation): ≤ 0.70 mbar
95l/min (inhalation): ≤ 2.4 mbar
160l/min (exhalation): ≤ 3 mbar

FFP3

53916 3,80€

0,03	10	200	1600
Kg	Sub	Box	Tray



- Filtering material of 3 layers: polypropylene.
- Nosepiece to fit the mask nose area to the shape of the face.
- Exhalation valve.

- Elastic headbands made of natural rubber strap without latex.
- Headbands plastic clips.
- Internal lining to improve the half-mask sealing and comfortability.

EXHALATION VALVE

Approved according to EU regulation 2016/42

Penetration into the filter material

≤ 1%

Maximum time of use

8 hours

DISPOSABLE

HYGIENIC

53797 0,10€

0,00	50	2000	24000
Kg	Sub	Box	Tray

53957 0,26€

0,01	50	2000	24000
Kg	Sub	Box	Tray

EBF: Efficacy to Bacterial Filtration

>98%

Respiratory resistance

35-50 Pa

Approved according to UNE 0064-1:2020



NON-MEDICAL USE
Presentation in box with 5 bags with 10 units each.

SHOE DISINFECTANT MAT

MAT WITH TANK

FOR DISINFECTANT LIQUID

53862 6,00€

1,45	-	5	100
Kg	Sub	Box	Tray

- Size: 85x55x10cm
- Material: TPE
- Max. recommended capacity: 3L
- Max. capacity: 8L



DRYING MAT

53863 3,00€

0,70	-	5	240
Kg	Sub	Box	Tray

- Size: 76x48cm
- Material: Polyester

LIQUID FOR MAT 53862

53893 5,00€

4,30	-	4	128
Kg	Sub	Box	Tray



AUTOMATIC SHOE COVER DISPENSER

53781 18,00€

2,20	-	8	32
Kg	Sub	Box	Tray

- Allows to cover the feet with plastic covers only by placing them inside the dispenser.
- Includes 8 suction cups in the bottom for a better grip, and 100pcs of shoe cover.



Material: ABS plastic
100PCS SHOE COVER

14781 990€

0,25	-	84	336
Kg	Sub	Box	Tray



AUTOMATIC GEL DISPENSER 1200ml

53902 25,00€

1,15	-	18	144
Kg	Sub	Box	Tray

- Liquid supply: Adjustable from 0.7ml - 1.4ml.
- Compatible with liquid soap, alcohol, gel and hand sanitizer.
- Voltage: 6V 1.5A
- Size: 160x120x295mm.
- Material: ABS.

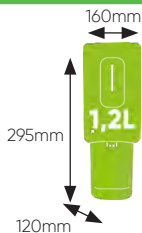

ACTIVATION DISTANCE SENSOR: 50-150MM



AC/DC ADAPTOR 6V 1.5A

15059 10,00€

0,10	-	200	-
Kg	Sub	Box	Tray

R14 C1.5V CELL

15062 1,00€

0,05	24	480	-
Kg	Sub	Box	Tray

Includes bracket and screws to fix on the wall.

AUTOMATIC GEL DISPENSER 400ML

53826 16,00€

0,35	-	40	400
Kg	Sub	Box	Tray

- Compatible with liquid soap, alcohol, gel and hand sanitizer.
- Infrared motion sensor blue LED indicator light.
- Dosage: 1ml.
- Voltage: 6V (4 batteries 1.5V).
- Batteries not included.



DOSING PUMP FOR CANISTER

14793 12,00€

0,05	-	100	1200
Kg	Sub	Box	Tray



EXTENDABLE FLOOR STANDING HAND SOAP DISPENSER

53827 14,00€

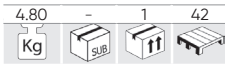

EXTENSIBLE
1.25m - 1.58m

FOR

53902 25,00€

- Adjustable length: 1.25m - 1.58m
- Weight: 4.3kg
- Material: Steel
- Color: Black
- Shelf dimensions: 417x67mm
- Dispenser support dimensions: 480x133mm
- Base diameter: 395mm

INFRARED THERMOMETER

53794 28,00€

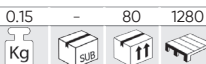
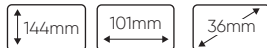

- WITH SOUND ALARM
- MEMORY UP TO 32 READINGS
- LCD SCREEN



measuring distance:
15 - 50mm

- Measure body temperature in **1 second** and **without contact**.
- Automatic shutdown after 1 minute.

Range 32.0°C - 42.2°C (89.6°F - 108°F)
Precision ±0.2°C (35°C - 42°C)

CE 0123
2 A batteries

PVC ZIPPER BAG

14918 0,23€

25 x 30cm

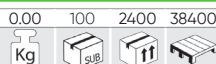

14919 0,45€

60 x 18 cm

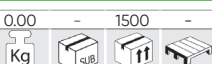

SURFACE CLEANER LIQUID

LIQUID FORMAT



SPRAY FORMAT

Cleans all types of surfaces:
home - car - office - Air Conditioning

- Ideal for clean all types of surfaces.
- Physical aspect: Transparent liquid.
- Contains: Isopropanol / Ethanol.



Universal useful accessory.

GUN FOR SPRAY CANS

53829 14,00€



53828 6,00€



53824 2,85€



53804 0,80€

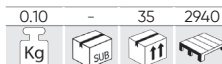

52493 4,50€

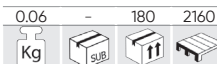

CARE AND HYGIENE OF HANDS: SANITIZERS AND HYDROALCOHOLIC FORMULAS



- Contains: propan-2-ol, alcohol isopropilico Etanol / propan-1-ol, n-propanol

How to use: Apply a sufficient amount of the product to healthy, dry skin and rub for at least 30 seconds. It does not need rinsing.

GEL FORMAT



53832 1,81€

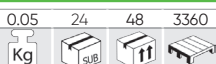

53791 4,80€

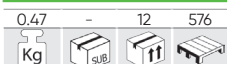

LOTION FORMAT

valid for surfaces

- Hydroalcoholic solution with **glycerin** and **aloe vera** for hygiene and hand care.



53822 2,50€

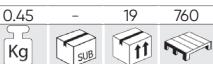

FOAM FORMAT

53803 0,90€



ANTIFOG FACE SHIELDS

53798 1,95€

Complies with EN166



Direct protection against fluids/ liquids and bacteria.

- Covered with foam on the inside to improve the comfort of use.
- Screen anti-fog treatment.
- Adjustable



THERMAL CAMERA FOR TEMPERATURE MEASUREMENT SYSTEM

53830 1.300,00€



Power: 12VDC

Relay: +:NO -:COM

Internet: RJ45



Audio Relay Internet Power

Works by IP connection

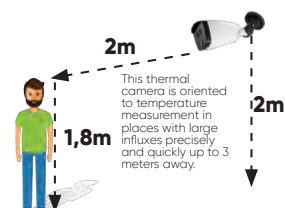
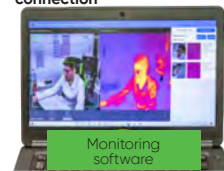

2m
1.8m
2m
This thermal camera is oriented to temperature measurement in places with large influxes precisely and quickly up to 3 meters away.

METHACRYLATE SCREEN PROTECTOR

53835 16,00€

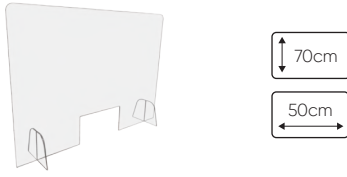
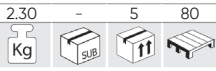

53836 16,00€

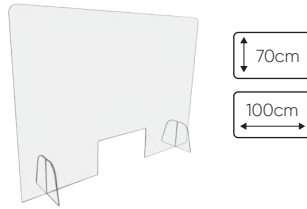
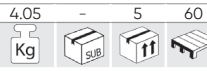

Thickness: 5mm
Hole: 300x160mm
Base: 150x200mm

BARRIER TAPE 200M

53811 8,90€

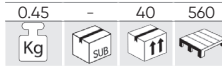

53987 0.59
9,50€
Kg

PLASTIC CHAIN POST HIGH VOLTAGE

53940 13,20€

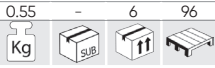

- Material: PVC.

CHAIN NOT INCLUDED

For a simple, fast and mobile fencing of interior and exterior areas.

Its contrasting colors make the chain highly visible to restrict access.



REFILLABLE BASE

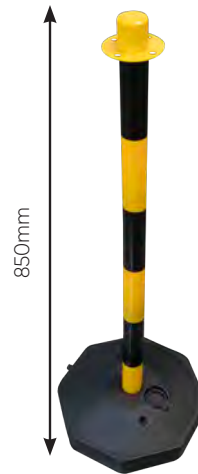

PLASTIC S-HOOK

53942 0,50€

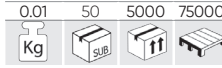

PLASTIC CHAIN

53941 6,05€

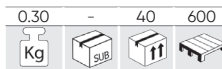

- Length: 5m
- Link: 6mm
- Color: Red / White



PLASTIC CHAIN POST

53808 16,50€

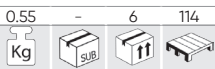

- Material: PVC.

CHAIN NOT INCLUDED



REFILLABLE BASE



PLASTIC S-HOOK

53839 0,25€

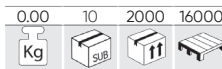

PLASTIC CHAIN

53809 8,00€



- Length: 5m
- Link: 6mm
- Color: Red / White



SEPARATION POLE WITH RETRACTABLE TAPE

53914 75,00€

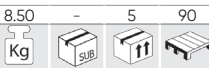

- Material: Steel
- Tube diameter: 63mm
- Base diameter: 320mm
- Height: 910mm

- 4-way tape output
- Tape length: 3m
- Tape width: 48mm

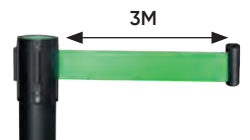

4-WAY TAPE OUTPUT

ADHESIVE WARNING TAPE SAFETY DISTANCE

53840ES 6,00€

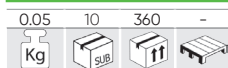

1.000x1.000 mm

AVAILABLE IN ANY LANGUAGE

- Text:
" PLEASE! KEEP THE SAFETY DISTANCE"

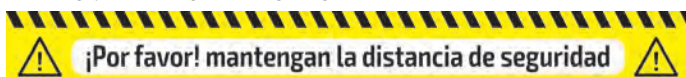

PLASTIC FLOOR STAND - SOCIAL DISTANCING

53812 23,50€



PORTABLE OZONE AIR PURIFIER

Valid for disinfection of the environments and surfaces. Eliminates viruses, bacterias and all kind of odors.

OLOR ODOR
VIRUS VIRUSES
BACTERIAS BACTERIA
HCHO
+
HYGIENE
ANTIBACTERIA
PURIFIES

5.000mg/h

53786 98,00€

2.20 - 8 32
Kg SUB

158mm 172mm 187mm

67W 2 Amp 5x20mm 80 CFM

5000mg/h

PLATE FOR REF. 53786

14775
30,50€



600mg/h

53796 76,00€

0.90 - 8 128
Kg SUB



80mm 130mm 180mm

15W 600 mg/h

12V 220V 15m³/h

- LIGHT, FAST AND POWERFUL
- LOW NOISE LEVEL
- PORTABLE SIZE



IDEAL FOR VEHICLES



Connection to electricity and connection to cigarette lighter socket.

Recommended operating time for different room volume:

50m ³	100m ³	150m ³	200m ³	300m ³	20min	40min	60min	80min	100min
------------------	-------------------	-------------------	-------------------	-------------------	-------	-------	-------	-------	--------

10.000mg/h

53805 220,00€

2.80 - 4 40
Kg SUB

275mm 190mm 235mm



95W 1000mg/h 220V 240V 20000h

PLATE FOR REF. 53805

14802
44,00€



Room volume	Work time required
50m ³	8 min
100m ³	16 min
150m ³	24 min
200m ³	32 min
300m ³	48 min

- Light, fast and powerful.
- Low noise level.
- 3 types of disinfection: ozone, ion, ozone + ion.
- Timer and hold mode.
- Portable size with handle.

10.000mg/h - 20.000mg/h

53806 250,00€

3.90 - 4 32
Kg SUB

242mm 233mm 300mm



UV

INCORPORATES UV LIGHT FOR STERILIZE

PLATE FOR REF. 53806

14803
43,00€



190W 120 CFM 220V 240V 20000h 50 dB

2 OPTIONAL STAGES

LOW 10.000mg/h		HIGH 20.000mg/h	
Room volume	Work time required	Room volume	Work time required
50m ³	8 min	500m ³	30 min
100m ³	16 min	600m ³	40 min
150m ³	24 min	700m ³	50 min
200m ³	32 min	800m ³	60 min
300m ³	48 min	900m ³	70 min
500m ³	65 min	1.000m ³	80 min

OZONE TREATMENT BOX

53838 38,00€

1.10 - 8 96
Kg SUB



DISINFECTATION TIME

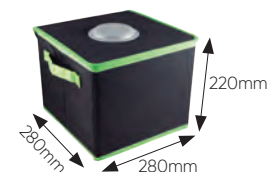
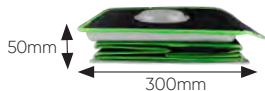

WITH POCKET



DETACHABLE

The box is very easy to assemble and disassemble, making it convenient to transport.



- UV Wavelength: UV: 254nm.
- Power supply: Micro-USB connector.



5V 2W Amp 0.38-0.42 UV 1550 uW/cm² 12V 1.5-2.0 mg/h

- HYGIENE
- POWERFUL
- SAFE AND EFFECTIVE

- ODOR REMOVAL
- FAST
- FOLDABLE: EASY TO CARRY AROUND

OZONE METER

53802 120,00€

0.65 - 20 240
Kg SUB



- Accuracy: $\leq \pm 5\%$ F.S.
- Measuring range: 0-50ppm (0-98mg/m³)
- Low alarm: 5ppm (98mg/m³)
- High alarm: 10ppm (196 mg/m³)
- Response time: <30 seconds
- Operating temperature: -10°C - 55°C
- IP65 protection.



109x60x30mm

TWO CONFIGURABLE ALARM LEVELS FOR DIFFERENT CONCENTRATION LEVELS

WORKING TIME: >8H

CHARGING TIME: 4H-6H

complies with: EN61326-1, EN61000-4-2, EN61000-4-3



CONSUMABLES

- 324 GROMMETS / ROLL PINS
- 325 COTTER PINS / SCREWS
- 327 NUT RIVETS
- 328 WASHERS
- 331 VALVE CORES
- 332 O-RINGS
/ HEAT SHRINK SOLDER SLEEVES
- 333 GREASE NIPPLE FITTINGS
- 334 HOSE CLAMPS / SPRINGS / FUSES
- 335 WIRE CONNECTORS
- 336 PLASTIC CLIPS

E-CIRCLIP ASSORTMENT

53348 14,00€

0,30 6 24 672
Kg SUB ff



150
PCS



M1.5	M3	M5	M6	M9	M12	M15	M19	M22
15 PCS	15 PCS	20 PCS	25 PCS	25 PCS	20 PCS	10 PCS	10 PCS	10 PCS

RUBBER GROMMET ASSORTMENT

53349 14,00€

0,25 6 24 672
Kg SUB ff



125
PCS



19,5x23 2 PCS	16x24 3 PCS	13x15 3 PCS	11,5x19 4 PCS	10x20 3 PCS	10x12 5 PCS	25 2 PCS	22 3 PCS	19 4 PCS	15 5 PCS
9,8x11,5 6 PCS	8x14 3 PCS	7,5x13 7 PCS	6x7,5 10 PCS	3,5x6 15 PCS	12 10 PCS	9 20 PCS	7 20 PCS		

WHITE GROMMETS ASSORTMENT

53370 26,00€

0,30 6 12 -
Kg SUB ff

190
PCS



M2	M3	M4	M5	M6	M8	M10
25 PCS	25 PCS	30 PCS	30 PCS	30 PCS	20 PCS	20 PCS

ROLL PIN ASSORTMENT

53350 14,00€

0,40 6 24 -
Kg SUB ff

120
PCS



1/16x3/16 4u.	3/32x1-1/4 4u.	3/16x1 5u.	1/4x1-3/4 4u.
1/16x5/16 4u.	1/8x5/8 5u.	3/16x1-1/4 5u.	5/16x3/4 4u.
1/16x3/4 4u.	1/8x1 5u.	7/32x5/8 4u.	5/16x1-1/2 4u.
5/64x1/4 4u.	1/8x1-1/4 5u.	7/32x1-1/4 4u.	5/16x2 4u.
5/64x1/2 4u.	5/32x5/8 4u.	7/32x1-3/4 4u.	3/8x3/4 2u.
5/64x1 4u.	5/32x1 4u.	1/4x5/8 4u.	3/8x1-1/2 2u.
3/32x5/8 4u.	5/32x1-1/2 4u.	1/4x1-1/4 4u.	3/8x2 2u.
3/32x1 4u.	3/16x5/8 5u.		

COTTER PIN ASSORTMENT

52027 14,00€

0,90 6 12 432
Kg SUB ff

365
PCS



1,2x25mm 50 PCS	1,6x32mm 50 PCS	2x40mm 50 PCS	2,5x40mm 50 PCS	3,2x40mm 50 PCS
3,2x50mm 50 PCS	4x50mm 40 PCS	5x63mm 10 PCS	6,3x63mm 15 PCS	

INOX COTTER PIN ASSORTMENT

53372 26,00€

1,30 6 12 -
Kg SUB ff

144
PCS



3x50mm 50 PCS	4x60mm 30 PCS	5x75mm 20 PCS	6x50mm 20 PCS	6x75mm 16 PCS	8x60mm 8 PCS
------------------	------------------	------------------	------------------	------------------	-----------------

LYNCH PIN ASSORTMENT

53371 29,00€

1,45	6	12	288
Kg	Sub	11	11

50
PCS



	5x36	6x45	8x45	11x45
	16 PCS	18 PCS	6 PCS	10 PCS

CLEVIS PIN AND R-CLIP ASSORTMENT

53363 34,00€

1,15	6	24	-
Kg	Sub	11	11

71
PCS



	8x50	9,5x50	11x63	12,5x50
	5 PCS	18 PCS	5 PCS	3 PCS

	3,5x44	2,5x42	2,5x58	2x3
	6 PCS	20 PCS	7 PCS	7 PCS

R-CLIP ASSORTMENT 150 PIECES

52044 19,00€

0,55	6	12	384
Kg	Sub	11	11

150
PCS



MACHINE KEY ASSORTMENT

53364 16,00€

0,80	6	24	-
Kg	Sub	11	11

60
PCS



	3x3x25	3x3x20	5x5x30	5x5x25	5x5x20	6x6x40	6x6x30
	4 PCS	4 PCS	5 PCS	5 PCS	5 PCS	5 PCS	5 PCS
	6x6x20	8x8x40	8x8x30	10x10x40	10x10x30	12x12x40	12x12x40
	5 PCS	5 PCS	5 PCS	5 PCS	5 PCS	2 PCS	2 PCS

SPARE PARTS AVAILABLE IN BAGS



REF.	SIZE	UNI.	€/u.
10882	2,00x32mm	42	0,25€
10883	1,60x36mm	30	0,25€
10884	1,60x42mm	25	0,25€
10793	2,30x43mm	25	0,25€
10794	3,20x52mm	20	0,40€
10795	3,80x75mm	8	0,60€

EYE BOLT ASSORTMENT

53352 12,00€

0,60	6	24	672
Kg	Sub	11	11

151
PCS



	2,4x25	4x45	4x50
	60 PCS	12 PCS	12 PCS

	2,4x41	4x64	4,2x85
	50 PCS	12 PCS	5 PCS

METRIC HEAD SCREW ASSORTMENT

53351 12,50€

0,90	6	12	-
Kg	Sub	11	11

240
PCS



	4x12	4x20	5x16	5x25
	10 PCS	10 PCS	10 PCS	10 PCS
	6x20	6x30	8x25	8x40
	10 PCS	10 PCS	5 PCS	5 PCS
	10x16	10x40		
	5 PCS	5 PCS		

	4	5	6	8	10
	20 PCS	20 PCS	20 PCS	10 PCS	10 PCS
	4	5	6	8	10
	20 PCS	20 PCS	20 PCS	10 PCS	10 PCS

SELF TAPPING SCREW ASSORTMENT

53354 14,00€

0,55	6	24	-
Kg	Sub	ff	ff

200 PCS



#8x12.5	#8x16	#8x19	#8x25	#10x12.5	#10x16	#10x19	#10x25
30 PCS	30 PCS	30 PCS	30 PCS	20 PCS	20 PCS	20 PCS	20 PCS

ALLEN CAP BOLTS ASSORTMENT

53362 14,00€

0,65	6	24	672
Kg	Sub	ff	ff

106 PCS

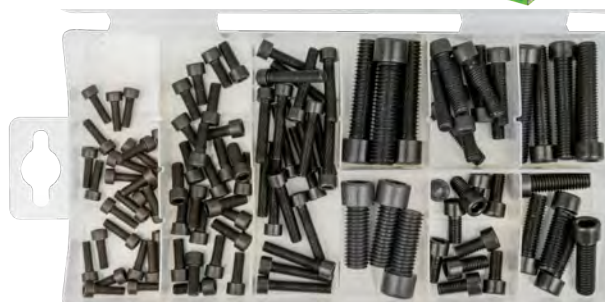

4x12	5x12	5x25	10x40	6x25	8x40	10x25	6x12	8x25
25 PCS	25 PCS	20 PCS	3 PCS	10 PCS	5 PCS	3 PCS	10 PCS	5 PCS

U-CLIP AND SCREWS ASSORTMENT

53366 14,00€

0,30	6	24	672
Kg	Sub	ff	ff

170 PCS



M3 5X8	M4 2X16	M4.2	M3.5	M3.5
40 PCS	20 PCS	20 PCS	20 PCS	20 PCS
M6.35X19	M5X12	M5	M5	M6.35
15 PCS	10 PCS	15 PCS	15 PCS	10 PCS

SCREWS ASSORTMENT

53369 14,00€

0,65	6	24	672
Kg	Sub	ff	ff

550 PCS



2.8X13mm	3.5x13mm	3.5x19mm	4.2x16mm	4.2x31mm	4.8x25mm	2.8x16mm
65 PCS	65 PCS	45 PCS	40 PCS	20 PCS	20 PCS	55 PCS
3.5x10mm	3.5x16mm	4.2x13mm	4.2x25mm	4.8x19mm	4.8x32mm	
60 PCS	60 PCS	50 PCS	30 PCS	25 PCS	15 PCS	

SELF-LOCKING NUT ASSORTMENT

52029 14,00€

1,01	6	12	360
Kg	Sub	ff	ff

228 PCS



M3	M4	M5	M6	M8
50 PCS	50 PCS	40 PCS	30 PCS	20 PCS
M10	M12	M14	M16	
15 PCS	10 PCS	8 PCS	5 PCS	

NUT ASSORTMENT

52028 15,20€

1,05	6	12	360
Kg	Sub	ff	ff

243 PCS



SPARE PARTS AVAILABLE IN BAGS

REF.	SIZE	UNI.	€/u.	REF.	SIZE	UNI.	€/u.
10805	M3	50	0,10€	10812	M14	8	0,30€
10779	M4	50	0,05€	10813	M16	5	0,30€
10780	M5	50	0,05€				
10781	M6	50	0,05€				
10784	M8	50	0,05€				
10785	M10	20	0,10€				
10786	M12	40	0,15€				



METRIC WING NUT ASSORTMENT

53365 14,00€

0,75	6	24	-
Kg	Sub	Tray	Tray



150
PCS



	M4	M5	M6	M8	M10
	40 PCS	40 PCS	25 PCS	25 PCS	20 PCS

ALUMINIUM RIVET NUT ASSORTMENT

53361 24,00€

0,20	6	24	672
Kg	Sub	Tray	Tray



150
PCS



3x9	4x11	5x13	6x15	8x18	10x21
40 PCS	35 PCS	25 PCS	25 PCS	15 PCS	10 PCS

NUT RIVET ASSORTMENT

52703 22,00€

0,79	6	24	480
Kg	Sub	Tray	Tray

235
PCS



M3	M4	M5	M6	M8	M10	M12
50 PCS	50 PCS	50 PCS	40 PCS	20 PCS	15 PCS	10 PCS

ZINC RIVET NUT ASSORTMENT

53360 18,00€

0,45	6	24	672
Kg	Sub	Tray	Tray



150
PCS



3x9	4x11	5x13	6x15	8x18	10x21
40 PCS	35 PCS	25 PCS	25 PCS	15 PCS	10 PCS

SPARE PARTS AVAILABLE IN BAGS

REF.	SIZE	UNI.	€/u.
13235	M3	200	0,15€
13236	M4	200	0,15€
13237	M5	200	0,15€
13238	M6	100	0,20€
13239	M8	50	0,20€
13240	M10	40	0,40€
13241	M12	20	0,55€



RIVET ASSORTMENT

52043 16,50€

0,80	6	12	384
Kg	Sub	Tray	Tray

300
PCS



4,8x16,9mm	4,8x24,8mm	
50 PCS	40 PCS	
3,2x9,7mm	4,8x12,7mm	4,8x20mm
90 PCS	70 PCS	50 PCS

PLASTIC RIVET ASSORTMENT

52711 27,50€

0,44	6	24	384
Kg	Sub	Tray	Tray



150
PCS

RIVETER AVAILABLE AT PAGE 48 AND 127 (REF. 52575)



SPARE PARTS AVAILABLE IN BAGS



REF.	SIZE	UNI.	€/u.
13674	6x19,3mm	25	0,50€
13675	6x17,8mm	25	0,50€
13676	6x25,5mm	25	0,50€
13677	6x24,5mm	25	0,50€
13678	6x24mm	25	0,50€



6x19,3mm	6x17,8mm	6x25,5mm
25 PCS	25 PCS	25 PCS
6x24,5mm	6x24mm	6x24mm
25 PCS	25 PCS	25 PCS



SPARE PARTS AVAILABLE IN BAGS

REF.	SIZE	Kg	Sub	Tray	Tray	€/u.
10877	4,8x16,90mm	0,04	5	500	2.000	0,25€
10878	4,8x24,80mm	0,01	10	500	1.800	0,30€
10879	3,2x9,70mm	0,02	10	500	4.000	0,20€
10880	4,8x12,70mm	0,03	10	500	2.000	0,20€
10881	4,8x20,00mm	0,04	10	500	1.480	0,25€



ASSORTMENT SCREWS, NUTS, WASHERS

51804 58,00€

5,68	-	5	120
Kg	Sub	Box	Tray

828
PCS

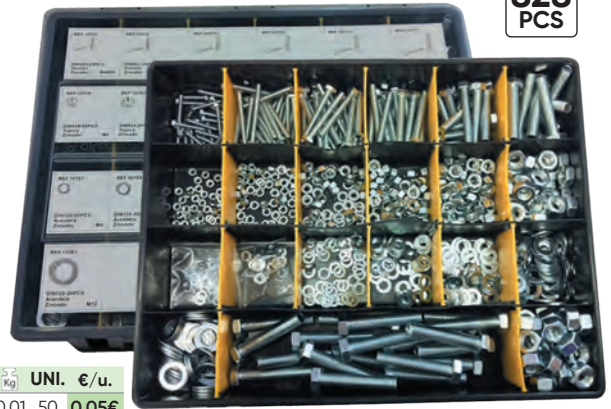

SPARE PARTS AVAILABLE IN BAGS

REF.	SIZE	5g Kg	UNI.	€/u.
10772	Zinc-plated screw DIN 933 8.8 M4x25	0,01	25	0,05€
10773	Zinc-plated screw DIN 933 8.8 M5x25	0,01	25	0,10€
10774	Zinc-plated screw DIN 933 8.8 M6x25	0,01	25	0,10€
10775	Zinc-plated screw DIN 933 8.8 M7x50	0,01	15	0,15€
10776	Zinc-plated screw DIN 933 8.8 M8x50	0,01	15	0,20€
10777	Zinc-plated screw DIN 933 8.8 M10x50	0,04	12	0,20€
10778	Zinc-plated screw DIN 933 8.8 M12x60	0,05	20	0,35€
10779	Zinc-plated nut DIN 934 M4	0,02	50	0,05€
10780	Zinc-plated nut DIN 934 M5	0,01	50	0,05€
10781	Zinc-plated nut DIN 934 M6	0,01	50	0,05€
10782	Zinc-plated nut DIN 934 M7	0,01	50	0,05€
10784	Zinc-plated nut DIN 934 M8	0,01	50	0,05€
10785	Zinc-plated nut DIN 934 M10	0,01	50	0,10€
10786	Zinc-plated nut DIN 934 M12	0,01	40	0,15€
10787	Zinc-plated washer DIN 125 M4	0,01	50	0,05€



REF.	SIZE	5g Kg	UNI.	€/u.
10788	Zinc-plated washer DIN 125 M5	0,01	50	0,05€
10789	Zinc-plated washer DIN 125 M6	0,01	50	0,05€
10790	Zinc-plated washer DIN 125 M7	0,01	50	0,05€
10791	Zinc-plated washer DIN 125 M8	0,01	50	0,05€
10792	Zinc-plated washer DIN 125 M10	0,01	50	0,05€
10783	Zinc-plated washer DIN 125 M12	0,01	50	0,05€
50959	Box 19 compartments	0,7	1	12,00€

GALVANIZED IRON FLAT WASHER ASSORTMENT

52158 38,50€

3,45	-	5	90
Kg	Sub	Box	Tray

5x20x1,5mm 50 PCS	6x20x1,5mm 50 PCS	7x20x1,5mm 50 PCS
8x20x1,5mm 50 PCS	8x20x1,75mm 50 PCS	10x30x2,5mm 25 PCS
6x30x2mm 25 PCS	7x30x2mm 25 PCS	8x30x2mm 25 PCS
4x11x0,98mm 50 PCS	12x40x3mm 25 PCS	4x20x1,5mm 50 PCS



475
PCS

FLAT WASHER ASSORTMENT

53377 20,00€

1,60	6	12	-
Kg	Sub	Box	Tray



20x6x1.5 20 PCS	20x8x1.5 20 PCS	20x10x1.5 20 PCS	25x6x1.5 20 PCS
32x2x1.5 20 PCS	32x4x1.5 20 PCS	32x6x1.5 20 PCS	32x8x1.5 20 PCS
25x10x1.5 20 PCS	32x10x1.5 20 PCS	32x10x1.5 20 PCS	25x8x1.5 20 PCS



240
PCS

ALUMINIUM 18 FLAT WASHERS CASE

52031 44,00€

0,56	6	18	288
Kg	Sub	Box	Tray

3x7x1,5mm 50 PCS	4x8x1,5mm 50 PCS	5x6x1,5mm 50 PCS	16x22x1,5mm 50 PCS	14x22x1,5mm 50 PCS	14x20x1,5mm 50 PCS
6x10x1,5mm 50 PCS	6x11x1,5mm 50 PCS	7x11x1,5mm 50 PCS	7x12x1,5mm 50 PCS	8x12x1,5mm 50 PCS	8x14x1,5mm 50 PCS
9x12x1,5mm 50 PCS	10x14x1,5mm 50 PCS	11x16x1,5mm 50 PCS	11x17x1,5mm 50 PCS	12x16x1,5mm 50 PCS	12x16x1,5mm 50 PCS



900
PCS

CASE OF BLACK GROWER WASHERS

52032 28,00€

1.735
PCS

1,68 - 5 870



	3mm 600 PCS	4mm 400 PCS	5mm 220 PCS	6mm 220 PCS	8mm 110 PCS
	10mm 65 PCS	12mm 50 PCS	14mm 40 PCS	16mm 30 PCS	

INJECTOR COPPER WASHERS ASSORTMENT

53229 38,70€

150
PCS

0,40 5 20 720



13.8x7.3x1.4mm 10 PCS	15.0x7.0x2.0mm 10 PCS	15.0x7.5x2.5mm 10 PCS	16.0x7.5x1.7mm 10 PCS	16.0x7.5x2.0mm 10 PCS	16.4x7.5x2.0mm 10 PCS
14.6x7.5x1.3mm 10 PCS	15.0x7.5x1.0mm 10 PCS	15.0x7.5x2.0mm 10 PCS	15.0x7.5x3.0mm 10 PCS	16.0x7.5x1.5mm 10 PCS	20.0x9.4x0.9mm 10 PCS
14.6x7.5x3.0mm 10 PCS	15.0x7.5x1.5mm 10 PCS	15.5x7.5x2.0mm 10 PCS			

53340 86,00€

375
PCS

0,90 - 10 1050

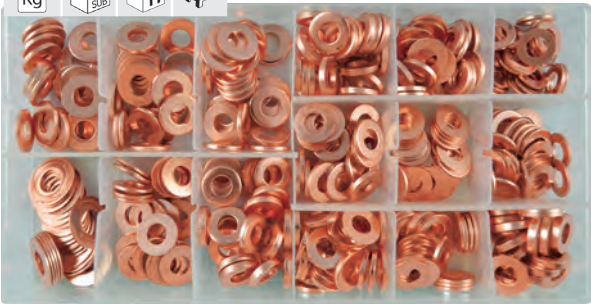

13.8x7.3x1.4mm 25 PCS	15.0x7.0x2.0mm 25 PCS	15.0x7.5x2.0mm 25 PCS	15.5x7.5x2.0mm 25 PCS	16.0x7.5x2.0mm 25 PCS
14.6x7.5x1.3mm 25 PCS	15.0x7.5x1.0mm 25 PCS	15.0x7.5x2.5mm 25 PCS	16.0x7.5x1.5mm 25 PCS	16.4x7.5x2.0mm 25 PCS
14.6x7.5x3.0mm 25 PCS	15.0x7.5x1.5mm 25 PCS	15.0x7.5x3.0mm 25 PCS	16.0x7.5x1.7mm 25 PCS	20.0x9.4x0.9mm 25 PCS

X
SPARE PARTS
AVAILABLE
IN BAGS

13819 50 6,50€ 13.8 x 7.3 x 1.4 mm	13822 50 11,00€ 15.0 x 7.0 x 2.0 mm	13825 50 11,50€ 15.0 x 7.5 x 2.0 mm	13828 50 11,50€ 15.5 x 7.5 x 2.0 mm	13831 50 12,60€ 16.0 x 7.5 x 2.0 mm
13820 50 7,00€ 14.6 x 7.5 x 1.3 mm	13823 50 6,00€ 15.0 x 7.5 x 1.0 mm	13826 50 13,00€ 15.0 x 7.5 x 2.5 mm	13829 50 10,50€ 16.0 x 7.5 x 1.5 mm	13832 50 13,00€ 16.4 x 7.5 x 2.0 mm
13821 50 14,00€ 14.6 x 7.5 x 3.0 mm	13824 50 8,00€ 15.0 x 7.5 x 1.5 mm	13827 50 15,00€ 15.0 x 7.5 x 3.0 mm	13830 50 10,50€ 16.0 x 7.5 x 1.7 mm	13833 50 9,00€ 20.0 x 9.4 x 0.9 mm

COPPER WASHERS ASSORTMENT

52030 98,00€

900
PCS

1,21 3 18 288



50 SPARE PARTS AVAILABLE

REF.	SIZE	Kg	€ / u.	REF.	SIZE	Kg	€ / u.
10823	3x7x1,5mm	0,01 50	0,20€	10836	10x14x1,5mm	0,01 50	0,30€
10824	4x8x1,5mm	0,01 50	0,20€	10837	11x16x1,5mm	0,01 50	0,30€
10825	5x6x1,5mm	0,01 50	0,20€	10838	11x17x1,5mm	0,01 50	0,30€
10826	16x22x1,5mm	0,01 50	0,40€	10839	12x16x1,5mm	0,01 50	0,40€
10827	14x22x1,5mm	0,01 50	0,60€	10840	12x18x1,5mm	0,01 50	0,35€
10828	14x20x1,5mm	0,01 50	0,45€				
10829	6x10x1,5mm	0,01 50	0,20€				
10830	6x11x1,5mm	0,01 50	0,20€				
10831	7x11x1,5mm	0,01 50	0,20€				
10832	7x12x1,5mm	0,01 50	0,20€				
10833	8x12x1,5mm	0,01 50	0,20€				
10834	8x14x1,5mm	0,01 50	0,25€				
10835	9x12x1,5mm	0,01 50	0,25€				



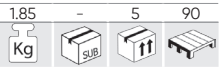

INJECTOR COPPER RING ASSORTMENT 551 PCS

53464 153,00€







30 SPARE PARTS AVAILABLE

 UNIVERSAL Ø15.0X8.0X1.5 13945 7,40€	 MERCEDES Ø15.0X7.0X1.5 13946 6,70€	 RENAULT Ø13.0X7.5X2.5 13947 5,85€
 IVECO, FORD, BMW, MAN Ø15.0X7.5X1.5 13948 5,00€	 UNIVERSAL Ø15.0X7.5X2.0MM 13949 6,50€	 UNIVERSAL Ø15.45X8.0X2.0 13950 7,80€
 MAZDA Ø13.5X10X2.0 13951 5,15€	 FORD Ø15.5X7.5X2.5 13952 10,90€	 LAND ROVER Ø15.5X7.5X1.5 13953 8,00€
 RENAULT Ø15.0X7.5X3.0 13954 12,70€	 DEUTZ Ø13.0X7.0X1.5 13955 4,95€	 FORD Ø13.5X7.5X1.5 13956 4,30€
 FIAT Ø15.0X7.5X1.5 13957 9,70€	 MAN ROVER Ø15.5X7.5X1 13958 5,45€	 MERCEDES Ø16.5X7.5X2 13959 10,10€
 KIA Ø13.7X7.3X3 13960 9,65€	 KIA Ø13.7X7.3X2 13961 9,25€	 STEEL Ø10X6.0X1.0 13962 1,76€
 BRASS Ø15.8X7.5X3.0 13963 12,40€	 PLASTIC NOZZLE T-TYPE 13964 15,00€	 ALUMINIUM Ø8X5.8X1 13965 1,50€
 PLASTIC NOZZLE L-TYPE 13966 12,90€	 SPRING 13967 4,65€	

Ø15.0X8.0X1.5 30 PCS	Ø15.0X7.0X1.5 12 PCS	Ø13.0X7.5X2.5 30 PCS	Ø15.0X7.5X1.5 30 PCS	Ø15.45X8.0X2.0 30 PCS
Ø15.45X8.0X2.0 30 PCS	Ø13.5X10X2.0 12 PCS	Ø15.5X7.5X2.5 30 PCS	Ø15.5X7.5X1.5 12 PCS	Ø15.0X7.5X3.0 30 PCS
Ø13.0X7.0X1.5 12 PCS	Ø13.5X7.5X1.5 30 PCS	Ø15.0X7.5X1.5 12 PCS	Ø15.5X7.5X1 12 PCS	Ø16.5X7.5X2 30 PCS
Ø13.7X7.3X3 12 PCS	Ø13.7X7.3X2 12 PCS	Ø10X6.0X1.0 50 PCS	Ø15.8X7.5X3.0 30 PCS	Ø8X5.8X1 30 PCS
"T" 20 PCS	"L" 30 PCS	spring 25 PCS		

OIL DRAIN PLUG GASKETS

 Ø 10MM / 0,02KG 52719 0,19€ 0.04 Kg 100 sub 5000 150000	 RUBBER (Ford) Ø 13MM / 0,01KG 51554 0,28€ 0.01 Kg 100 sub 5000 180000	 Ø 16MM / 0,01KG 51799 0,20€ 0.01 Kg 50 sub 2500 120000
 Ø 12MM / 0,03KG 51843 0,19€ 0.01 Kg 100 sub 5000 200000	 Ø 14MM / 0,01KG 51546 0,19€ 0.01 Kg 100 sub 5000 150000	

OIL DRAIN PLUG COOPER WASHERS ASSORTMENT

52163 95,00€

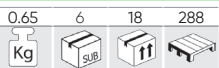

Ø10MM 100 PCS	Ø12MM 100 PCS	Ø14MM 100 PCS
Ø16MM 100 PCS	Ø18MM 100 PCS	Ø20MM 25 PCS



COMPRESSIBLE



COPPER WASHER ASSORTMENT

53353 18,00€

0,20	6	24	720
Kg	Sub	ft	ft

110 PCS



	M6	M8	M10	M12	M14	M16
	30 PCS	25 PCS	20 PCS	15 PCS	10 PCS	10 PCS

STARLOCK WASHERS ASSORTMENT

53373 14,50€

0,25	6	24	672
Kg	Sub	ft	ft

260 PCS



	M3x10	M4x12	M5x14	M6x14	M8x18	M10x20	M12x25
	30 PCS	30 PCS	40 PCS	50 PCS	50 PCS	40 PCS	20 PCS

EXTERNAL SNAP RING ASSORTMENT

53383 11,50€

0,20	6	24	672
Kg	Sub	ft	ft

300 PCS



	M4	M6	M8	M10	M12
	50 PCS	40 PCS	45 PCS	30 PCS	30 PCS
	M14	M16	M18	M20	M22
	25 PCS	25 PCS	25 PCS	15 PCS	15 PCS

INTERNAL SNAP RING

53382 11,00€

0,15	6	24	672
Kg	Sub	ft	ft

300 PCS

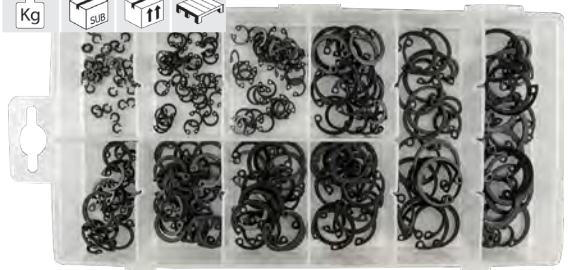

	M4	M6	M8	M10	M12
	50 PCS	40 PCS	45 PCS	30 PCS	30 PCS
	M14	M16	M18	M20	M22
	25 PCS	25 PCS	25 PCS	15 PCS	15 PCS

FIBRE WASHER ASSORTMENT

53381 14,50€

0,19	6	12	384
Kg	Sub	ft	ft

600 PCS



	10x5.5x1	16x10x1	19x12x1	22x16x1	22.5x14x1	32x22x1
	160 PCS	80 PCS	40 PCS	30 PCS	20 PCS	20 PCS
	12x6.5x1	16x8x1	20x12.5x1	27x20x1	25.4x17.5x1	32x24x1
	100 PCS	60 PCS	40 PCS	20 PCS	15 PCS	15 PCS

CAR AIR CONDITIONER VALVE CORE SET

53599 30,30€

0,16	10	100	-
Kg	Sub	ft	ft



134 PCS



	R12	R134A
	5mm L: 19mm	6mm L: 19mm
	6mm L: 19mm	7mm L: 20mm
	R12	
	5mm L: 19mm	6mm L: 22mm
	6mm L: 22mm	8mm L: 22mm
	5mm L: 19mm	6mm L: 26.5mm
	6mm L: 26.5mm	9mm L: 22mm

SPARE PARTS AVAILABLE

REF.	SIZE	5 Kg	10 Kg	€ / u.
14594	5x19mm R12 (GREEN)	0,01	10	2,00€
14595	5x19mm	0,01	10	1,50€
14596	5x19mm R12	0,01	10	2,00€
14597	6x19mm	0,01	10	7,60€
14598	6x26mm	0,01	10	17,80€
14599	7x20mm R134A	0,01	10	4,50€
14600	6x22mm	0,01	10	9,50€
14601	8x22mm	0,01	10	11,00€
14602	9x22mm	0,01	10	11,00€

O-RING SEALING GASKET WASHER ASSORTMENT

METRIC - 386 UNITS

386
PCS

CASE TOP						
Position in case	006	007	008	009	010	011
Rubber width (mm)	2	2	2	2	2	2
Ø Inner (mm)	3	4	5	6	7	8
Quantity	16	16	16	16	16	16
Position in case	113	112	111	110	012	
Rubber width (mm)	2.5	2.5	2.5	2.5	2	
Ø Inner (mm)	14	12	11	10	10	
Quantity	13	13	13	13	17	
Position in case	114	115	116	210		
Rubber width (mm)	2.5	2.5	2.5	3		
Ø Inner (mm)	16	17	19	19		
Quantity	13	13	13	10		
CASE BASE						
Position in case	222	325	326	327		
Rubber width (mm)	3	4	4	4		
Ø Inner (mm)	38	38	41	44		
Quantity	12	10	9	9		
Position in case	221	220	219	218	217	
Rubber width (mm)	3	3	3	3	3	
Ø Inner (mm)	36	35	33	32	30	
Quantity	12	12	12	12	12	
Position in case	211	212	213	214	215	216
Rubber width (mm)	3	3	3	3	3	3
Ø Inner (mm)	20	22	24	25	27	28
Quantity	12	12	12	12	12	12

50651 16,50€

0.55 5 20 360



INCHES - 386 UNITS

CASE TOP						
Position in case	006	007	008	009	010	011
Rubber width	1/16	1/16	1/16	1/16	1/16	1/16
Ø Inner	1/8	5/32	3/16	7/32	1/4	5/16
Quantity	20	20	20	20	20	20
Position in case	113	112	111	110	012	
Rubber width	3/32	3/32	3/32	3/32	1/16	
Ø Inner	9/16	1/2	7/16	3/8	3/8	
Quantity	13	13	13	13	13	
Position in case	114	115	116	210		
Rubber width	3/32	3/32	3/32	1/8		
Ø Inner	5/8	11/16	3/4	3/4		
Quantity	13	13	13	10		
CASE BASE						
Position in case	222	325	326	327		
Rubber width	1/8	3/16	3/16	3/16		
Ø Inner	11/2	11/2	15/8	13/4		
Quantity	10	7	7	7		
Position in case	221	220	219	218	217	
Rubber width	1/8	1/8	1/8	1/8	1/8	
Ø Inner	17/16	13/8	15/16	11/4	13/16	
Quantity	10	10	10	10	10	
Position in case	211	212	213	214	215	216
Rubber width	1/8	1/8	1/8	1/8	1/8	1/8
Ø Inner	13/16	7/8	15/16	1	11/16	11/8
Quantity	10	10	10	10	10	10

50652 16,50€

0.66 5 20 360



AIR CONDITIONING RUBBER O-RING ASSORTMENT 270PCS

50807 38,00€

0.16 6 24 672



5.29X1.78MM	6.07x1.78mm	6.8x1.9mm			
20 PCS	20 PCS	20 PCS			
7.65x1.78mm	7.80x1.90mm	8.0X2.0MM	8.80X1.90MM	10.82X1.78MM	
20 PCS	20 PCS	20 PCS	20 PCS	15 PCS	
10.77X2.62MM	11.0X2.0MM	12.0X2.0MM	13.9x1.80mm	13.95x2.62mm	
15 PCS	15 PCS	15 PCS	10 PCS	10 PCS	
14.0X2.0MM	15.0X2.0MM	17.0X2.00MM	17.17x1.78mm	17.04x3.53mm	
10 PCS	10 PCS	10 PCS	10 PCS	10 PCS	

270
PCS



HEAT SHRINKS TUBE ASSORTMENT

53374 10,00€

0.15 6 24 672



53376 10,50€

0.15 6 24 672



GAS TORCH

51920 18,00€

0.14 10 100 400



53374

53376



127
PCS

M2x40	M2.5x40	M3.5x40	M5x40	M7x80	M10x80	M13x85
30 PCS	25 PCS	20 PCS	20 PCS	16 PCS	8 PCS	8 PCS

PAGE 206

332

HEAT SHRINK SOLDER SLEEVE SET 100PCS

53992 18,00€

- Allows an easy and quick connection of cables, soldering and sealing.
- Solder ring material: tin
- Material: PE

100
PCS

0.10 6 84 1512
Kg SUB



 Ø1.7mm 0.25-0.34mm ² 26-24 AWG 25 PCS	 Ø2.7mm 0.5-1.0mm ² 22-18 AWG 35 PCS	 Ø4.7mm 1.5-2.5mm ² 16-14 AWG 30 PCS	 Ø6.0mm 4.0-6.0mm ² 12-10 AWG 10 PCS
---	---	---	---

VACUUM CONNECTORS ASSORTMENT KIT

53910 19,00€

0.25 6 24 480
Kg SUB



STRAIGHT			REDUCER	
 4.8x4.8 10 PCS	 6.3x6.3 8 PCS	 3.17x3.17 30 PCS	 9.5x6.3 6 PCS	 6.3x4.8 10 PCS
 7.9x7.9 6 PCS	 9.5x9.5 6 PCS			
TEE				
 3.9x3.9x3.9 8 PCS	 4.8x4.8x4.8 8 PCS	 3.17x3.17x3.17 12 PCS		
 6.3x6.3x6.3 6 PCS	 9.5x9.5x9.5 3 PCS			

113
PCS



53434 18,00€

0.15 6 24 672
Kg SUB



 4x28.7 10 PCS	 3.9x30.8 5 PCS	 10.4x44.4 10 PCS	 5.6x47.1 5 PCS
 7.9x38 10 PCS	 4.7x38.9 5 PCS	 5.2x33.9 10 PCS	 7x30 10 PCS

65
PCS



GREASE NIPPLE FITTING ASSORMENT 135 PIECES

52033 43,00€

0.89 6 24 576
Kg SUB

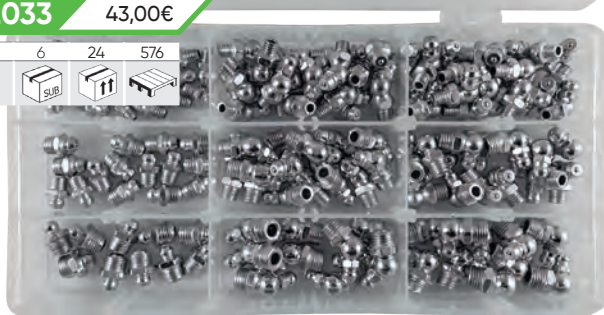

SPARE PARTS AVAILABLE

135
PCS



90° ANGLE

REF.	SIZE	Kg	u.	€/u.
10874	6x1	0,01	20	0,30€
10875	8x1	0,01	15	0,40€
10876	10x1	0,01	10	0,45€



RIGHT ANGLE

REF.	SIZE	Kg	u.	€/u.
10868	6x1	0,01	20	0,30€
10869	8x1	0,01	20	0,30€
10870	10x1	0,01	10	0,45€



45° ANGLE

REF.	SIZE	Kg	u.	€/u.
10871	6x1	0,01	20	0,30€
10872	8x1	0,01	15	0,40€
10873	10x1	0,01	10	0,45€

GREASE NIPPLE FITTING ASSORMENT

53359 16,00€

0.49 6 24 672
Kg SUB



 90° ANGLE 5 PCS	 RIGHT ANGLE 60 PCS	 45° ANGLE 5 PCS
 8x1.25 5 PCS	 8x1.25 10 PCS	 8x1.25 5 PCS
 10x1.5 5 PCS	 10x1.5 10 PCS	 10x1.5 5 PCS

110
PCS



HOSE CLAMP ASSORTMENT

53378 13,00€

0,45 6 24 672
Kg SUB fff

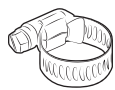
	1" 4 PCS	1-1/4" 2 PCS	1-3/4" 2 PCS	2" 4 PCS
	2-1/2" 2 PCS	3" 2 PCS	3-1/2" 2 PCS	4" 2 PCS







20
PCS



SPRING ASSORTMENT

53358 11,50€

0,35 6 24 672
Kg SUB fff

	5/16x1-3/4 12 PCS	9/32x1/2 10 PCS	1/4x13/32 10 PCS	7/32x11/16 10 PCS	7/32x1-1/2 10 PCS
	3/8x5/8 8 PCS	3/8x3/4 12 PCS	23/64x1-3/8 8 PCS	9/32x3/4 10 PCS	
	13/64x13/16 10 PCS	7/32x1 10 PCS	1/4x7/8 10 PCS	5/16x1-1/8 8 PCS	5/16x1-1/4 10 PCS
	3/16x1-3/4 8 PCS	9/32x1-1/2 10 PCS	11/32x1-7/16 10 PCS	11/32x1-27/32 12 PCS	9/32x2 12 PCS
					5/32x3-1/8 12 PCS



200
PCS



ELECTRICAL CLIP SET

53357 7,00€

0,01 6 24 1080
Kg SUB fff



2
PCS
30
AMP



MINI FUSE ASSORTMENT

53355 11,50€

0,15 6 24 672
Kg SUB fff



120
PCS



	5A 20 PCS	10A 20 PCS	15A 20 PCS	20A 20 PCS	25A 20 PCS	30A 20 PCS
---	-----------	------------	------------	------------	------------	------------

AUTO FUSE ASSORTMENT

53356 11,50€

0,25 6 24 672
Kg SUB fff

SPARE PARTS AVAILABLE

REF.	SIZE	Kg	u.	€/u.
10915	5A	0,01	20	0,25€
10917	10A	0,01	20	0,30€
10918	15A	0,01	20	0,30€
10919	20A	0,01	20	0,30€
10920	25A	0,01	20	0,25€
10921	30A	0,01	20	0,30€

	15A 20 PCS
---	------------

	5A 20 PCS	10A 20 PCS
---	-----------	------------

	20A 20 PCS	25A 20 PCS	30A 20 PCS
---	------------	------------	------------



120
PCS



AUTO FUSE ASSORTMENT

53367 9,50€

0,10 6 24 1560
Kg SUB fff



48
PCS

	5A 8 PCS	10A 8 PCS	15A 8 PCS		20A 8 PCS	25A 8 PCS	30A 8 PCS
---	----------	-----------	-----------	---	-----------	-----------	-----------

MINI FUSE ASSORTMENT

53368 9,00€

0,10 6 24 1368
Kg SUB fff

Mini fuse.



50
PCS



	5A 8 PCS	10A 8 PCS	15A 8 PCS	20A 8 PCS	25A 8 PCS	30A 10 PCS
--	----------	-----------	-----------	-----------	-----------	------------

MINI FUSE ASSORTMENT

53380 11,50€

0,15 6 24 672

Kg SUB 11 11



	5A 20 PCS	10A 20 PCS	15A 20 PCS
	20A 20 PCS	25A 20 PCS	30A 20 PCS



FUSES ASSORTMENT

52054 17,00€

0,30 6 24 672

Kg SUB 11 11



SPARE PARTS AVAILABLE



MINI XXA

REF.	COLOR	POWER	Kg	Sub	11	€/u.
10905	Blue	3A	0,01	20	-	0,25€
10906	Red	4A	0,01	20	-	0,25€
10907	Brown	5A	0,01	20	-	0,25€



STANDARD XXA

REF.	COLOR	POWER	Kg	Sub	11	€/u.
10914	Pink	4A	0,01	20	-	0,25€
10915	Yellow	5A	0,01	20	-	0,25€
12954	Purple	3A	0,01	20	-	0,25€

3A	4A	5A	7,5A	10A	15A	20A	25A	30A
20 PCS	20 PCS	20 PCS	20 PCS	20 PCS	20 PCS	20 PCS	20 PCS	20 PCS
3A	4A	5A	7,5A	10A	15A	20A	25A	30A
8 PCS	8 PCS	8 PCS	8 PCS	8 PCS	8 PCS	8 PCS	8 PCS	8 PCS



MINI XXA

REF.	COLOR	POWER	Kg	Sub	11	€/u.
10908	Yellow	7,5A	0,01	20	-	0,30€
10909	Pink	10A	0,01	20	1000	0,30€
10910	Blue	15A	0,01	20	-	0,30€



STANDARD XXA

REF.	COLOR	POWER	Kg	Sub	11	€/u.
10916	Brown	7,5A	0,01	20	-	0,30€
10917	Red	10A	0,01	20	4000	0,30€
10918	Blue	15A	0,01	20	3500	0,30€



MINI XXA

REF.	COLOR	POWER	Kg	Sub	11	€/u.
10911	Yellow	20A	0,01	20	1000	0,30€
10912	Grey	25A	0,01	20	-	0,25€
10913	Green	30A	0,01	20	-	0,30€



STANDARD XXA

REF.	COLOR	POWER	Kg	Sub	11	€/u.
10919	Yellow	20A	0,01	20	2000	0,30€
10920	Grey	25A	0,01	20	2000	0,25€
10921	Green	30A	0,01	20	2000	0,30€

635 PIECE INSULATED ELECTRICAL WIRE CONNECTOR ASSORTMENT

52053 45,00€

0,55 6 24 576

Kg SUB 11 11

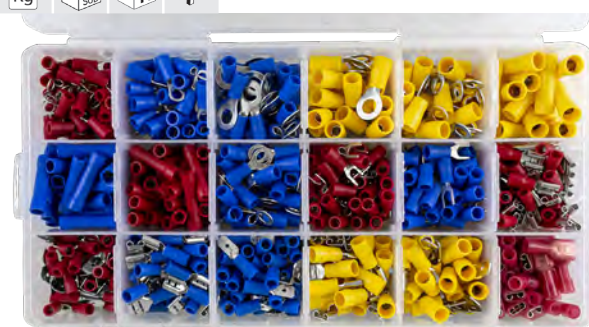

SPARE PARTS AVAILABLE



635 PCS



REF.	COLOR	POWER	Kg	Sub	11	€/u.
10885	Red	RV1.25-4S	0,01	20	-	0,20€
10886	Blue	RV2-4S	0,01	20	-	0,20€
10887	Blue	RV2-6S	0,01	20	-	0,25€
10888	Yellow	RV5.5-6S	0,01	20	-	0,30€
10889	Yellow	RV5.5-5S	0,01	20	-	0,30€
10893	Blue	RV2-5S	0,01	20	-	0,25€



REF.	COLOR	POWER	Kg	Sub	11	€/u.
10894	Red	SV1-4S	0,01	20	-	0,20€
10895	Blue	SV2-4S	0,01	20	-	0,20€



REF.	COLOR	POWER	Kg	Sub	11	€/u.
10890	Yellow	BV5.5	0,01	20	-	0,35€
10891	Blue	BV2	0,01	20	-	0,25€
10892	Red	BV1.25	0,01	20	-	0,30€



REF.	COLOR	POWER	Kg	Sub	11	€/u.
10896	Red	FDD1.25-250	0,01	20	2000	0,30€
10898	Blue	FDD2-250	0,01	20	1500	0,30€
10900	Yellow	FDD5.5-250	0,01	20	2000	0,30€



REF.	COLOR	POWER	Kg	Sub	11	€/u.
10902	Purple	FDNF 1.25-250	0,01	20	2000	0,30€



REF.	COLOR	POWER	Kg	Sub	11	€/u.
10897	Red	MDD1.25-250	0,01	20	-	0,30€
10899	Blue	MDD2-250	0,01	20	3000	0,30€
10901	Yellow	MDD5.5-250	0,01	20	-	0,25€

RV1.25-4S	RV2-4S	RV2-6S	RV5.5-6S	RV5.5-5S	BV5.5
50 PCS	50 PCS	30 PCS	20 PCS	20 PCS	15 PCS
BV2	BV1.25	RV2-5S	SV1-4S	SV2-4S	FDD1.25-250
25 PCS	30 PCS	40 PCS	50 PCS	40 PCS	45 PCS
MDD1.25-250	FDD2-250	MDD2-250	FDD5.5-250	MDD5.5-250	FDNF1.25-250
50 PCS	40 PCS	50 PCS	25 PCS	30 PCS	25 PCS

CRIMPING TOOL

IN PAGE 59



PLASTIC CLIP SETS

UNITS IN THE CASE | UNITS PER SPARE PARTS BAG



BAGS PER SUBBOX / BOX

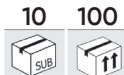

SPARE PARTS AVAILABLE

FOR MAZDA

52896 26,00€

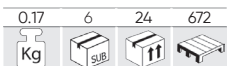

190 PCS

 13110 15 15 1,85€ OE 6508197AA	 13111 10 10 1,20€ OE B1016825200	 13112 6 6 1,65€ OE B09251833	 13113 20 20 2,20€ OE 992640543A	 13114 20 20 2,20€ OE B45556741	 13115 30 30 2,50€ OE G03158762
 13104 8 8 1,90€ OE 2042301	 13105 15 15 2,50€ OE 999100402	 13106 8 8 2,00€ OE B0016830200	 13107 8 8 2,15€ OE N30413356A	 13108 20 20 1,90€ OE 992640543A	 13109 30 30 2,90€ OE 99249051B



FOR TOYOTA / LEXUS

52886 18,00€

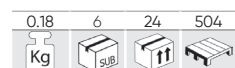

89 PCS

 13002 8 8 1,45€ OE 9018906001	 13003 5 4 1,70€ OE 9046707138	 13004 10 10 1,85€ OE 9046707117	 13005 10 10 1,25€ OE 9046709138	 13006 5 5 1,40€ OE 9046709101	 13007 10 10 1,30€ OE 75521611000
 13008 8 8 2,25€ OE 7503933060	 13009 4 4 1,65€ OE 9017905060	 13010 8 8 1,75€ OE 677711250	 13011 5 5 1,15€ OE 9046708124	 13012 8 8 1,80€ OE 7539533030	 13013 8 8 1,75€ OE 9046711063



FOR HONDA

52887 22,00€

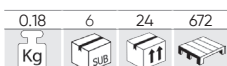

150 PCS

 13014 12 12 1,45€ OE 75103SJ4003	 13015 5 5 1,20€ OE 90675SB003	 13016 6 6 1,15€ OE 91566SP0003	 13017 25 25 2,60€ OE 91513SE003	 13018 25 25 1,45€ OE 91530ST5003	 13019 15 15 1,75€ OE 90687SA50030
 13020 8 8 1,70€ OE 91620SR2003	 13021 8 8 1,30€ OE 38529689A6300	 13022 10 10 2,10€ OE 90683SA5003	 13023 10 10 1,50€ OE 90672671003	 13024 18 18 2,45€ OE 91534SE0000	 13025 8 8 1,50€ OE 34355SD2003



FOR PEUGEOT / CITROËN

52899 34,00€

0,50	6	24	336
Kg			

345 PCS



- | | | | | | |
|---|---|---------------------------------------|---------------------------------------|---------------------------------------|---------------------------------------|
|
13128 50 50
1,85€
OE 947098 |
13129 20 20
2,00€
OE 856535 |
13130 20 20
3,75€
OE 6991W4 |
13131 20 20
3,45€
OE 6991W4 |
13132 25 25
2,65€
OE 694143 |
13133 35 35
3,45€
OE 743707 |
|
13134 30 30
3,95€
OE 7703074022 |
13135 35 35
3,45€
OE 7703077059 |
13136 15 15
2,60€
OE 698317 |
13137 25 25
2,25€
OE 699502 |
13138 30 30
2,85€
OE 6995X3 |
13139 40 40
3,85€
OE 69945 |

FOR FIAT

52900 34,00€

0,50	6	24	336
Kg			

308 PCS



- | | | | | | |
|---|---|---|---|---|--|
|
13140 30 30
2,65€
OE 14591784 |
13141 20 10
1,80€
OE 1459487 |
13142 25 25
3,10€
OE 1300433650 |
13143 8 8
1,95€
OE 71717421 |
13144 25 25
2,20€
OE 82456515 |
13145 25 25
3,85€
OE 5751139 |
|
13146 20 8
4,50€
OE 46306526 |
13147 25 25
3,10€
OE 14591687 |
13148 25 25
3,30€
OE 14591687 |
13149 25 25
3,10€
OE 14592387 |
13150 30 30
2,25€
OE 83468473 |
13151 50 50
5,35€
OE 7677865 |

FOR VOLVO

52901 34,00€

0,48	6	24	216
Kg			

350 PCS



- | | | | | | |
|---|--|---|---|--|--|
|
13152 25 25
3,05€
OE 8099905N07 |
13153 30 30
3,10€
OE 4292906 |
13154 20 20
3,20€
OE 12681763 |
13155 40 40
5,60€
OE 51131804205 |
13156 40 40
3,30€
OE 947098 |
13157 40 40
3,85€
OE 591740 |
|
13158 25 25
3,75€
OE 6384801G00 |
13159 20 20
3,20€
OE 9133417 |
13160 40 40
5,00€
OE 9133073 |
13161 30 30
3,55€
OE 3272075327462B |
13162 20 20
2,60€
OE 327462A |
13163 20 20
2,80€
OE 3923712 |

PLASTIC CLIP SETS

FOR VOLKSWAGEN

52889 19,00€

0,18 6 24 504
Kg SUB

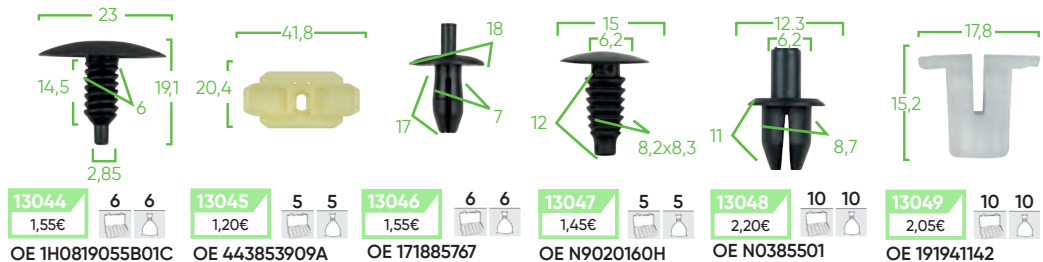
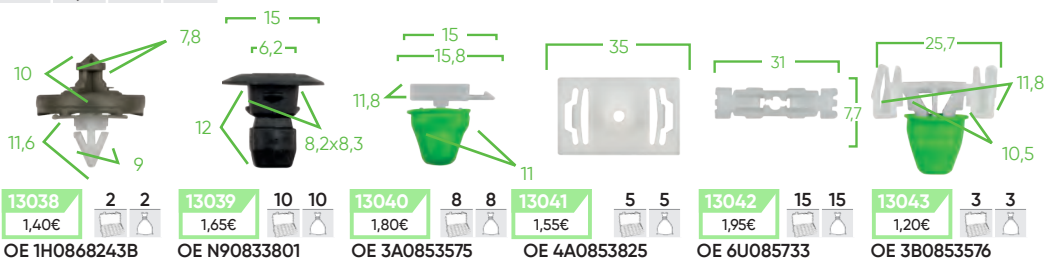

85
PCS



FOR BMW

52892 22,00€

0,17 6 24 672
Kg SUB

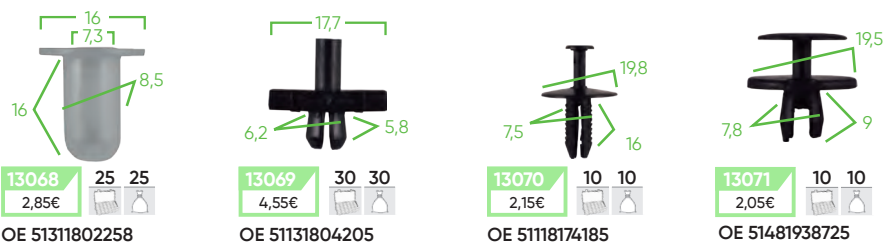

95
PCS



FOR NISSAN

52894 22,00€

0,15 6 24 672
Kg SUB

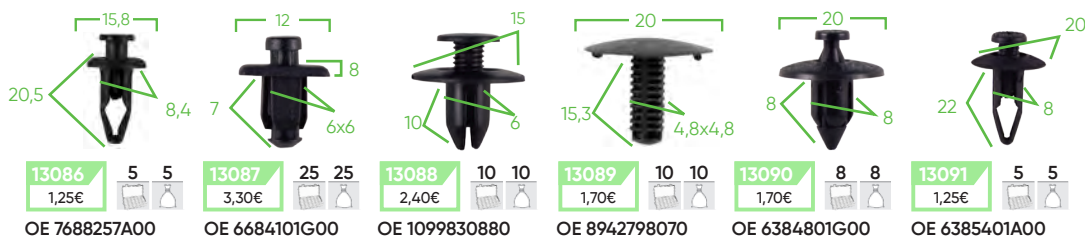
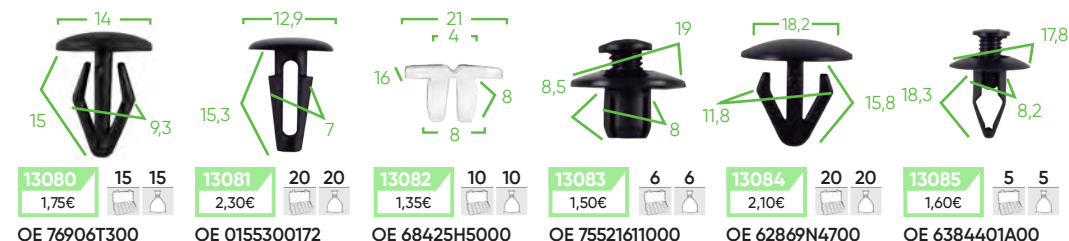

139
PCS



PLASTIC CLIP SETS

UNITS IN THE CASE UNITS PER SPARE PARTS BAG



BAGS PER SUBBOX / BOX



SPARE PARTS AVAILABLE

FOR AUDI

52890 22,00€

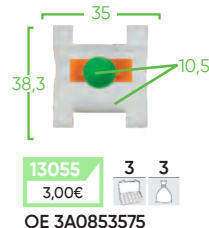
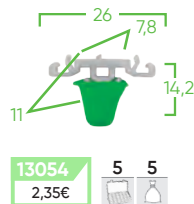
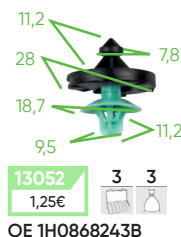

31
PCS

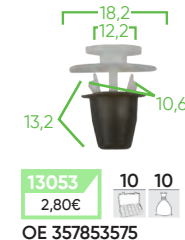
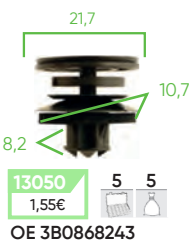

FOR FORD

52891 28,00€

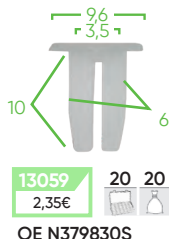
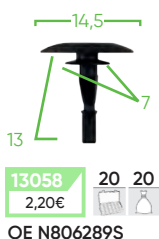
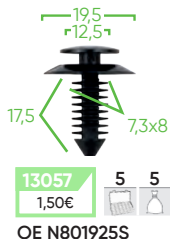
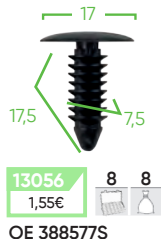

169
PCS

FOR BENZ

52893 26,00€

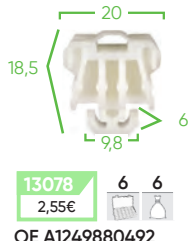
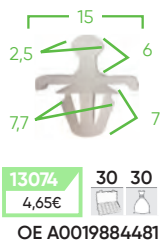

95
PCS

PLASTIC CLIP SETS

FOR RENAULT

52897 38,00€

0.43	6	24	336
Kg	SUB	11	



13116 50 50
5,45€

OE 7703077421



13117 50 50
3,65€

OE 7703074022



13118 60 60
15,90€

OE 7703081184

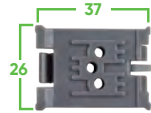

13119 15 15
5,60€

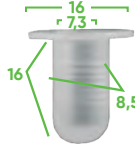

13120 60 60
5,50€

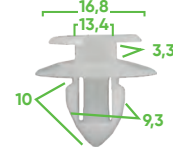

13121 65 65
8,75€

OE 7703077059

300
PCS



FOR MITSUBISHI

52895 22,00€

0.19	6	24	1500
Kg	SUB	11	



13092 15 15
1,65€

OE 8942180270

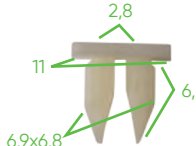

13093 30 30
2,95€

OE 9018905013

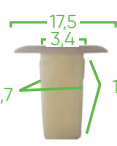

13094 10 10
1,50€

OE MU480033



13095 8 6
1,20€

OE 128100231



13096 8 8
1,70€

OE MU480034

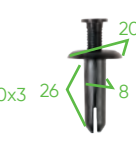

13097 3 3
1,20€

OE MR138807



13098 4 4
1,65€

OE MB253964

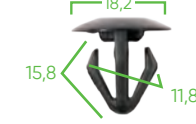

13099 30 30
2,75€

OE HB121467



13100 3 3
1,20€

OE MB271999



13101 8 8
1,50€

OE MB696120



13102 5 5
1,60€

OE MR200300

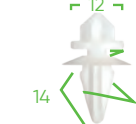

13103 10 10
1,80€

OE MB846992

132
PCS



FOR VAUXHALL / OPEL

52898 36,00€

0.45	6	24	360
Kg	SUB	11	



13122 20 20
1,95€

OE 90218614

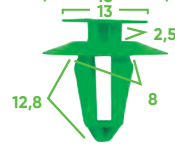

13123 40 40
5,35€

OE 174864



13124 100 100
8,20€

OE N0385501

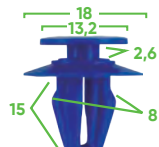

13125 50 50
5,95€

OE 2345959



13126 50 50
1,55€

OE 2240582



13127 40 40
5,60€

OE 180942

300
PCS



PLASTIC CLIP SETS







UNIVERSAL

52888 24,00€

0,17 6 24 672
Kg SUB 11 1

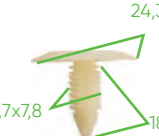
128 PCS

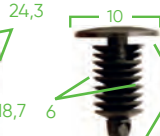
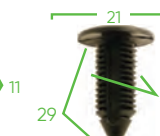
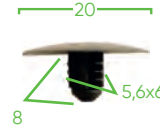
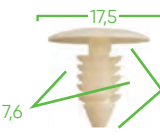
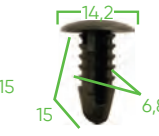
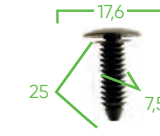

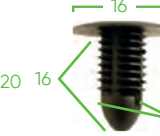
 17,5 17 7,5 13026 1,55€ 8 8 OE 388577S	 17,5 15 7,6 13027 1,85€ 10 10 GENERAL USE	 24,3 7,7x7,8 18,7 13028 1,45€ 6 6 OE 6003423	 24,3 7,7x7,8 18,7 13029 1,65€ 6 6 VW: N989022 CHRYSLER: 6003349 FORD: 385661	 10 11 6 13030 2,80€ 25 25 GM: 20699808 CHRYSLER: 6502328	 21 18 11,5 29 13031 1,85€ 4 4 FORD: N804379S
 20 8 5,6x6 13032 2,00€ 15 15 MAZDA: 6508197AA FORD: F22Z16774A	 17,5 7,6 15 13033 1,60€ 10 10 GM: 16674629 FORD: N8061135	 14,2 15 6,8 13034 2,65€ 20 20 NISSAN: 0153301781	 17,6 25 7,5 13035 1,65€ 6 6 GM: 10124502 BMW: 52201964201 LAND ROVER: DZM100080	 20 4 20 9,2 13036 1,40€ 6 6 VW: N9020160H FORD: 6998849 BMW: 51471904317 OPEL: 2207713	 16 7x7 13037 2,10€ 12 12 GENERAL USE









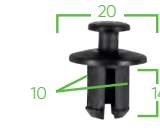

FOR BMW MINI FOR UPHOLSTERY

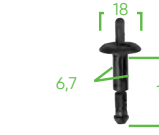
53720 19,00€

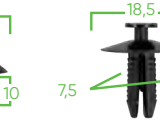
0,20 6 24 672
Kg SUB 11 1

112 PCS

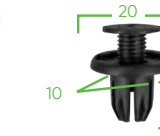
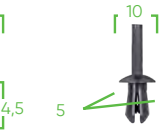

 20 10 14 14447 1,45€ 7 6 OE 51471911992	 15 7,3 15 14449 2,20€ 13 10 OE A0009905492	 18 6,7 17,8 14471 1,90€ 5 5 OE 51717002953	 22 10 10 14472 1,35€ 5 5 OE 51489119216	 18,5 7,5 16 14474 1,50€ 8 8 OE 51118174185	 24 5 10 14475 1,65€ 6 6 OE 2019900050
 12 11,5 20 7,2 14476 2,05€ 9 9 OE 51481915964	 9,9x9,6 14 6,6x7,2 14477 2,45€ 15 15 OE 0009881625	 7x6,7 14 14478 4,05€ 15 15 OE 7146976114	 20 10 14,5 14479 1,65€ 6 6 OE 91503SP0003	 10 5 11,6 14480 2,05€ 15 15 OE 51161943122	 15 8,8 8 14481 1,70€ 8 8 OE 51161943122



FOR BMW MINI FOR DOOR PANEL/MOLDING

53719 19,00€

0,15 6 24 672
Kg SUB 11 1

92 PCS

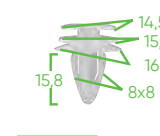
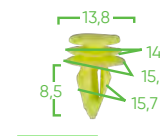

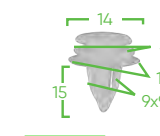
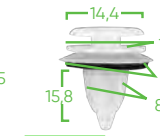
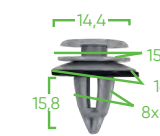
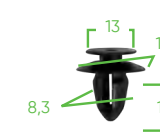
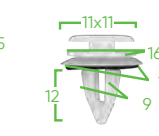
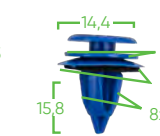
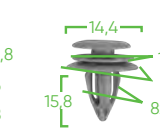
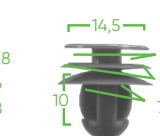
 14,5 15,8 16 15,8 8x8 14359 1,05€ 8 4 OE 51418224768	 13,8 14,4 15,5 8,5 15,7 14458 1,70€ 8 8 OE 51418224768	 12,8 15,3 17,4 14 9 14459 1,45€ 6 6 OE 51418224768	 30 15 22 14 14 14460 1,15€ 2 2 OE 7147122912	 14 15 17,5 15 9x9 14461 1,35€ 8 8 OE 51411973500	 14,4 15,8 16 8x8 14462 1,65€ 8 8 OE 51411973500
 14,4 15,8 16 15,8 8x8 14463 1,65€ 8 8 OE 51411973500	 13 17,5 8,3 13 14464 1,50€ 10 10 OE 611769	 11x11 16,5 17 12 9 14465 2,00€ 10 10 OE 7147145753	 14,4 15,8 16 15,8 8x8 14466 1,65€ 8 8 OE 51411973500	 14,4 15,8 16 15,8 8x8 14468 1,30€ 8 8 OE 51411973500	 14,5 16 17,5 10 7,7 14469 1,45€ 8 8 OE 7147133419

PLASTIC CLIP SETS

UNITS IN THE CASE



UNITS PER SPARE PARTS BAG



BAGS PER SUBBOX / BOX

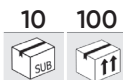

SPARE PARTS AVAILABLE

FOR MERCEDES-BENZ FOR UPHOLSTERY

53718 19,00€

0.20	6	24	672
Kg	Sub	Box	Case

 14422 1,50€ 6 6 OE A0009913940	 14446 2,80€ 20 20 OE 9903492	 14447 1,45€ 6 6 OE 51471911992	 14448 2,05€ 12 12 OE N105835019B9	 14449 2,20€ 10 10 OE A0009905492	 14450 2,15€ 12 12 OE N0385012
 14451 2,15€ 12 12 OE A1239900092	 14452 2,55€ 25 25	 14453 3,05€ 20 20	 14455 2,10€ 12 12	 14456 1,35€ 6 6	 14457 1,70€ 10 10 OE A1249900492

151 PCS



FOR MERCEDES-BENZ FOR DOOR PANEL/MOLDING

53717 19,00€

0.15	6	24	672
Kg	Sub	Box	Case

 14434 1,60€ 8 8 OE A0009910198	 14435 1,45€ 6 6	 14436 1,70€ 8 8 OE A0019912698	 14437 1,45€ 6 6	 14438 1,35€ 8 8 OE A0089880978	 14439 1,75€ 8 8 OE 0069884378
 14440 1,75€ 8 8 OE 0019884981	 14441 1,65€ 10 10	 14442 1,45€ 6 6	 14443 1,45€ 8 8	 14444 1,90€ 10 10 OE 0019886081	 14445 1,45€ 10 10

96 PCS



FOR VAG/SEAT/SKODA FOR DOOR PANEL/MOLDING/ UPHOLSTERY

53716 19,00€

0.15	6	24	672
Kg	Sub	Box	Case

 14422 1,50€ 6 6 OE A0009913940	 14423 3,55€ 15 15 OE 6E0837732	 14424 1,85€ 7 7	 14425 2,05€ 2 2 OE 6Q0868243	 14426 1,90€ 8 8 OE 171201969	 14427 1,20€ 8 4 OE 4D0807300
 14428 1,40€ 12 12 OE 251823717	 14429 1,80€ 6 6	 14430 2,25€ 3 3 OE 8E0821989A	 14431 1,45€ 2 2 OE 3B0868243	 14432 1,45€ 10 10 OE 1H0823717	

79 PCS



PLASTIC CLIP SETS





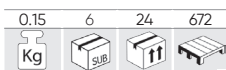



FOR PEUGEOT/CITROËN FOR UPHOLSTERY

53715 19,00€

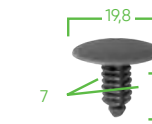

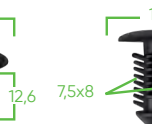
110 PCS

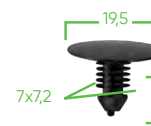

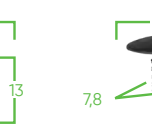
 14410 1,85€ 10 10 OE A1249900492	 14411 1,70€ 10 5	 14412 1,70€ 10 10	 14413 3,25€ 10 10	 14414 1,70€ 10 10 OE 2346824
 14415 1,70€ 10 10 OE A1249900492	 14416 1,25€ 10 5 OE 6992C6	 14419 1,95€ 15 15	 14420 1,50€ 15 15	 14421 2,45€ 10 10 OE 14093311

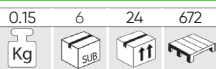

FOR PEUGEOT/CITROËN FOR DOOR PANEL

53713 16,00€



93 PCS

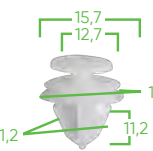
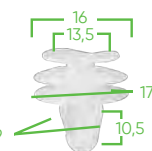

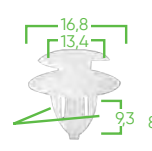
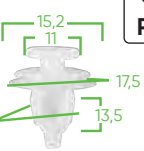
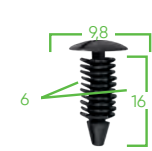
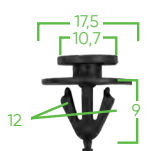
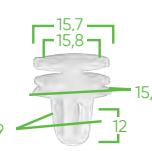
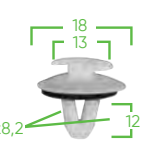
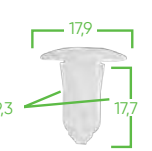
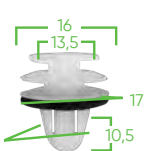
 14350 1,80€ 6 6 OE 6991Y8	 14358 1,70€ 10 10 PEUGEOT: 6991Y8 CITROËN: 6991Y8 FIAT: 9654280780 RENAULT: 7703077469	 14387 1,45€ 8 8	 14388 2,05€ 8 8 OE 7703077250	 14389 1,25€ 6 6 OE 6995A3	 14390 1,35€ 6 6
 14391 2,15€ 15 15	 14392 1,35€ 6 6	 14393 1,50€ 8 8	 14395 1,65€ 8 8	 14396 1,20€ 6 6	 14397 1,45€ 6 6

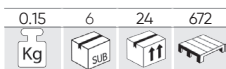

FOR PEUGEOT/CITROËN FOR MOLDING

53714 16,00€



80 PCS

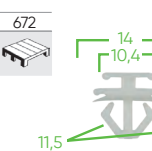
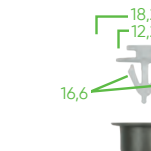
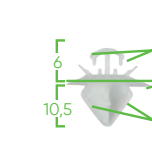
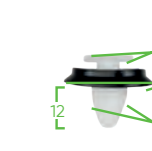
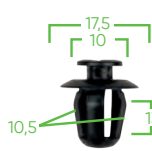
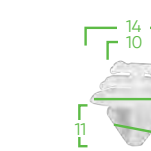

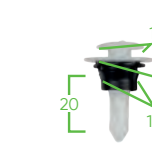
 14398 1,30€ 8 8 OE 6995X3	 14399 1,90€ 6 6 OE 129943	 14402 1,50€ 8 8 OE 856548	 14404 2,10€ 8 8 OE 71728806
 14405 1,45€ 16 8 OE 968865987703	 14406 1,55€ 10 10 OE 856540	 14408 1,45€ 10 10 OE 856534	 14409 1,35€ 8 8 OE 357853586

TRIM CLIP PULLER PLIER

53385 19,30€

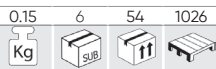

LEVERS SET

52851 9,65€

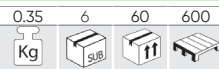

6 LEVER SET

53110 27,30€

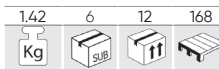

6 PCS

5"x8.5 / 5"x10.3
5"x4.5 / 15"x8.5
15"x10.3 / 15"x4.5mm



FOR RENAULT / DACIA FOR UPHOLSTERY

53712 16,00€

0,15	6	24	672
Kg	Sub	Box	Tray

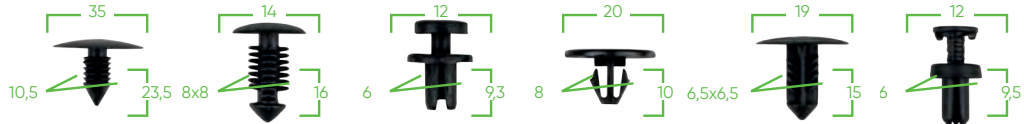

14374 1,70€ OE 7703077435	14375 1,85€ OE 7703072360	14376 2,60€ OE 7L6868307	14377 1,90€	14378 1,90€	14379 1,45€ OE 7703077117
--	--	---------------------------------------	-----------------------	-----------------------	--

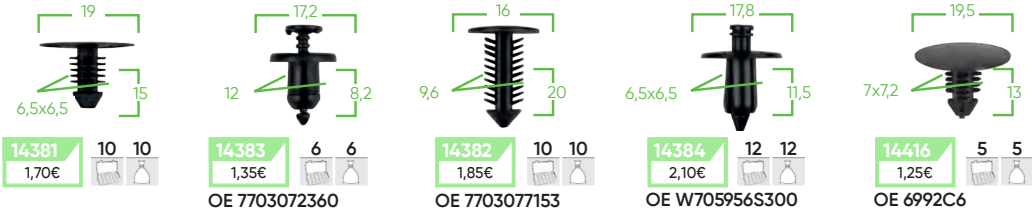

14381 1,70€	14383 1,35€ OE 7703072360	14382 1,85€ OE 7703077153	14384 2,10€ OE W705956S300	14416 1,25€ OE 6992C6
-----------------------	--	--	---	------------------------------------

109
PCS



FOR RENAULT / DACIA FOR MOLDING

53711 16,00€

0,20	6	24	672
Kg	Sub	Box	Tray

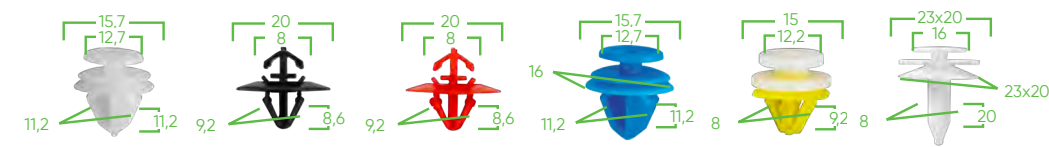

14358 1,70€	14364 1,90€	14365 1,90€	14366 1,45€	14356 1,90€	14367 1,30€
-----------------------	-----------------------	-----------------------	-----------------------	-----------------------	-----------------------

PEUGEOT: 6991Y8
CITROËN: 6991Y8
FIAT: 9654280780
RENAULT: 703077469

OPEL: 7701470779
NISSAN: 7703077421
RENAULT: 7703077421
IVECO: 500326896

OPEL: 7701470779
NISSAN: 7703077421
RENAULT: 7703077421
IVECO: 500326896

RENAULT: 7703077368
OPEL: 4430858

OE 7L5853994

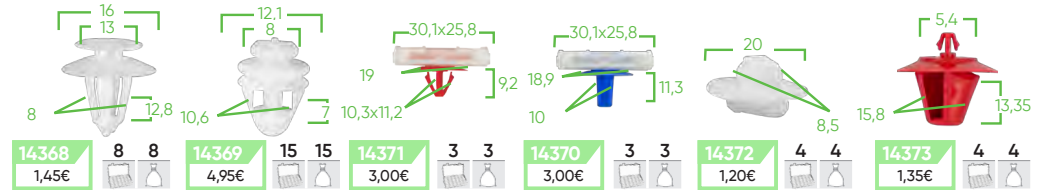

14368 1,45€	14369 4,95€	14371 3,00€	14370 3,00€	14372 1,20€ OE 7701061797	14373 1,35€
-----------------------	-----------------------	-----------------------	-----------------------	--	-----------------------

PEUGEOT: 6991Y8
CITROËN: 6991Y8
FIAT: 9654280780
RENAULT: 703077469

90
PCS



FOR RENAULT / DACIA FOR DOOR PANEL

53710 16,00€

0,20	6	24	672
Kg	Sub	Box	Tray

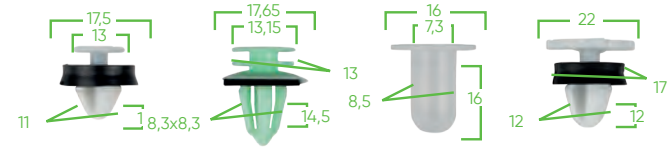

14350 1,80€ OE 6991Y8	14351 1,65€	14352 1,30€ OE 51447780135	14353 2,10€ OE 7703077476
------------------------------------	-----------------------	---	--

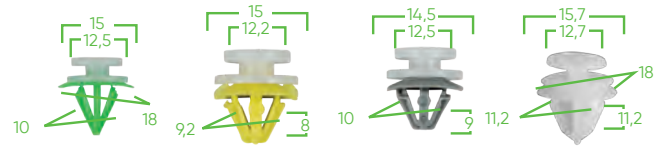

14355 1,70€ OE 7703077354	14356 1,90€ OPEL: 4430858 RENAULT: 7703077368	14357 1,90€ OE 7703077430	14358 1,70€ OE 51418224768
--	---	--	---

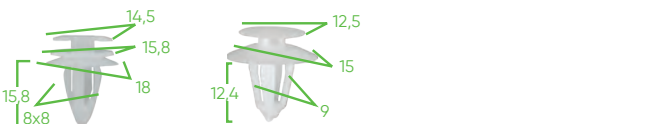

14359 1,05€	14368 1,45€
-----------------------	-----------------------

PEUGEOT: 6991Y8
CITROËN: 6991Y8
FIAT: 9654280780
RENAULT: 7703077469

85
PCS



CLIPS POSTER

15001 3,00€

Set of 2 informative posters of JBM plastic clips. With all the information of each clip (reference, price, measures).



330x1000mm



JBM®

CLOTHING

346 VEST
JACKET

JBM VEST

SIZE L

70002 37,50€

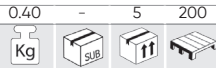

SIZE XL

70013 44,00€

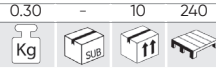

SIZE L

70015 44,00€

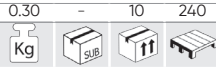

SIZE XL

70003 37,50€

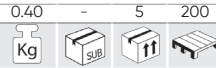

SIZE M

70014 44,00€

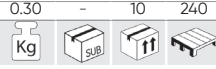

SIZE XL

70016 44,00€

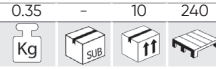

SIZE S

70009 37,50€

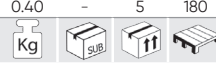

SIZE XXL

70017 44,00€

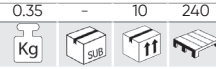

70002, 70003



70007, 70009



70013, 70014, 70015, 70016, 70017



JBM JACKET

SIZE L

70005 42,00€



70011 42,00€



SIZE XL

70012 42,00€

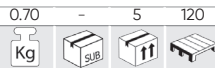

CLOTHES HANGER

13929 3,45€



HANGING RAIL

METEXP 62,00€





PROMOTIONAL

348 ELECTRONIC DEVICES JBM
352 PROMOTIONAL
354 DISPLAYS AND ACCESORIES
PACKAGING

SPORTS CAMERA

53865 48,00€

0.30 - 36 432



- ✓ A **water-resistant housing** that allows you to film up to **30 meters under water**.
- ✓ High-definition **LTPS LCD** screen.
- ✓ Easily replaceable battery.
- ✓ Digital video recording, photo shooting, video display, and audio recording.
- ✓ **120° HD wide-angle lens**.
- ✓ **Web camera**.
- ✓ Support storage cards up to **64GB**.
- ✓ **Multiple video recording formats**.
- ✓ **Motion detection and cyclic recording**.



HIGH-DEFINITION VIDEO RECORDING

DESIGNED FOR:

- Vehicle data recording
- Photo-shooting
- Outdoor sports
- Deep-water recording
- Etc.



ACCESSORIES:



GAMING CHAIR

53956 353,00€

21.50 - 1 4



- ✓ **Material:** Polyurethane
- ✓ **Iron frame thickness:** 1,2cm
- ✓ **Seating oam:** Moulded foam
- ✓ **Back foam:** Primary Foam
- ✓ **Armrest:** 2D
- ✓ **Gas lift:** Class 3
- ✓ **Nylon base:** 350mm



200Kg

BASE FOR REVOLVING CHAIR

15256 1.85
36,00€ Kg

RIGHT ARMREST

15257 1.35
27,50€ Kg

LEFT ARMREST

15258 1.35
27,50€ Kg

SHOCK ABSORBER

15259 0.85
18,00€ Kg

SET OF 5 CASTERS

15260 0.60
22,50€ Kg

JBM GAZEBO 3x3m

53973 284,00€

18.40 - 1 31



SIDE COVER FOR REF. 53973

15152 160,00€

2.25 - 5 -



It consists of two parts:
- Side part that covers 3/4 parts of the tent.
- Front part that covers 1/4 part of the tent. With vertical zipper as a door.



INCLUDES OUTER BAG FOR JBM DISPLAY:

14347 36,50€

0.60 - 5 -

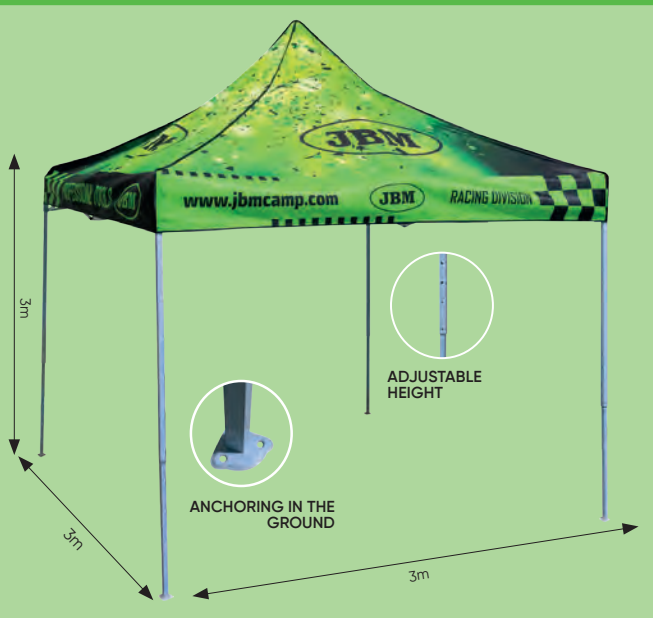

ROBOT VACUUM CLEANER

54020 288,00€

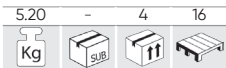

This intelligent robot automatically performs **vacuuming and scrubbing tasks**. Thanks to its intelligent mapping system, it can perform a thorough cleaning of the work area. It is highly configurable as it allows you to choose between different operating modes, adjust suction and humidity levels and schedule tasks for specific times.

4-5H 100-180min 14.8V 2600mAh



3,4kg 68 dB 20cm/s 1200 Pa



LEFT SIDE BRUSH

15340
5,50€



RIGHT SIDE BRUSH

15341
5,50€



MAIN BRUSH

15342
9,00€



HEPA FILTER

15343
9,50€



CLEANING TOOL

15344
6,50€



PACK OF 5 MOP

15345
10,50€



APP CONNECTION



DOCKING STATION

15346
24,00€



CHARGER

15349
8,50€



Máxima superficie cubierta
Maximum covered area
120m²

Capacidad tanque de agua
Water tank capacity
300ml

Capacidad del depósito de polvo
Dust box capacity
300ml

JBM BACKPACK

54043 48,00€

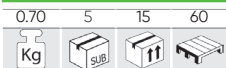

- ✓ **Storage space and pockets:** With a total of two compartments, it can hold laptops under 17.3 inches and tablets, among others.
- ✓ **Material:** Polyurethane, it is a waterproof, solid and durable backpack.
- ✓ **Lightweight and comfortable:** Comfortable and breathable sponge mesh design of the back and straps. Ergonomic



JBM POLO T-SHIRT

REF.	SIZE	Kg	Box	Units	€
13243	M	0,25	100	600	12,50€
13244	L	0,26	100	600	12,50€
13245	XL	0,28	100	600	12,50€



JBM PROMOTIONAL BAG

13968 1,35€

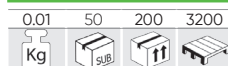

JBM MUG

54076 9,00€



VAT not included

JBM / www.jbmcamp.com

349

JBM PROMOTIONAL 4 COLORS PEN

53533 1,50€

0.01	50	1000	12000
Kg	Sub	Box	Tray



- 4-color pen: blue, red, black, green.

WITH RUBBER REAR POINTER TO WRITE ON TOUCH SCREENS



JBM PROMOTIONAL SCREEN

15789 2.545,00€

40.50	-	1	6
Kg	Sub	Box	Tray

The JBM promotional screen is the future of advertising for your business. It has a 43" LCD panel with LED technology, thanks to its design it will be the center of attention, to impact potential customers. The constantly changing images and videos will guarantee a strong attraction on the public. Unlike conventional advertising on billboards, signs, etc. Advertising on LED screens is very dynamic. Thanks to its characteristics, it will bring great benefits to your store.



AIR FRYER

54171 138,00€

4.90	-	2	18
Kg	Sub	Box	Tray



3,5L	≤65dB	220V 240V	1500W
80°C 200°C	360°	0-60'	



DYNAMIC SPIN BIKE

53930 276,00€

29.00	-	1	5
Kg	Sub	Box	Tray

- Time: 0:00~99:59min
- Distance: 0.00~9999 ml (km)
- Total distance: 0.00~9999 ml (km)
- Speed: 0.0~9999
- Calorie: 0.0~9999 kcal
- Pulse: 40~240 bpm
- Battery: size-AAA *2



COMFORTABLE SEAT



WITH WHEELS TO FACILITATE ITS TRANSPORT



FORCE ADJUSTMENT



GOOD GRIP

- COMPUTER FUNCTIONS:
- TIME
 - SPEED
 - DISTANCE
 - CALORIES
 - ODO
 - PULSE
 - SCAN



SCOOTER

53504 38,00€

3.50 - 6 36
Kg SUB ff

77mm 100mm



ADJUSTABLE

TREADMILL

53934 690,00€

0.25 10 40 1480
Kg SUB ff

1160mm 1450mm 675mm

110 KG

- Input voltage: 220V - 240V
- Input frequency: 50 - 60 Hz
- Rated Power: 550W
- Max power: 1500W (2.0HP)
- Speed: 1.0 - 12 level (Max speed 9.5 km/h)
- Folding size: 970x675x1275 mm
- Effective Running Lane: 400x1100 mm
- Function: Running, Massage, Sit-up
- Screen: 3.5" blue LED

DISPLAY FUNCTIONS:

- TIME
- SPEED
- DISTANCE
- CALORIES
- PULSE



KETTLE BBQ GRILL

53931 104,00€

6.10 - 1 18
Kg SUB ff

ACERO STEEL Cr Zn

- Type: square kettle grill
- Material: iron and wire
- Thickness: 0.4mm
- Finish: black powder coating
- Cooking grill: 43x40cm, chrome plated
- Charcoal grill: 36x36cm, zinc plated
- Cooking height: 59cm
- Legs: 430 stainless steel, 19mm diameter

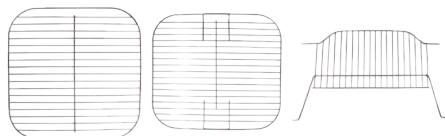

ONE COOKING GRILL, ONE CHARCOAL GRILL AND ONE WARMING GRILL

A VENT ON LID



LID-BLACK POWDER COATING AND BOWL-PORCELAIN IN BLACK

WITH A SIDE SHELF



STAINLESS STEEL LEGS

HAM HOLDER

14975 64,00€

2.95 - 4 80
Kg SUB ff

- Dimensions: 500x330x440mm
- Weight: 2,18kg



3 KNIVES SET

53511 23,00€

0.65 5 20 360
Kg SUB ff



3 PCS

JBM COOLER BAG

53949 4,50€

0.10 - 15 540
Kg SUB ff

350mm
675mm
675mm



24 PCS CUTLERY SET

53512 41,00€

1.90 - 12 144
Kg SUB ff



24 PCS

JBM PROMOTIONAL UMBRELLA

52857 7,50€

0.31 10 60 600
Kg SUB ff

84mm



PEARL NECKLACE

53513 9,00€

0.05 9 495 5940
Kg SUB ff



2 TOWELS SET

53510 24,00€

0.65 - 25 100
Kg SUB ff



2 PCS

VAT not included

JBM / www.jbmcamp.com

351

EMPTY TOOLS DISPLAY

53877 430,50€

42,00	-	1	-
Kg	Sub	Up	Down

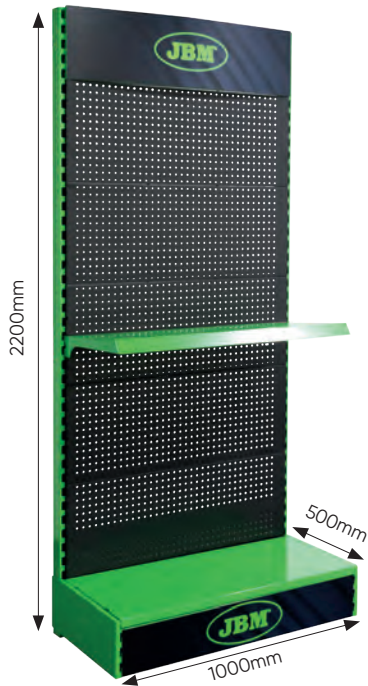

CONTAINS

14945 x1

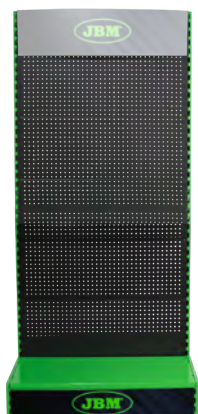

11318 x20



14380 x1

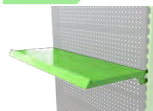

14946 x1



SPARE PARTS FOR TOOLS DISPLAY

14946 58,00€

3,40	-	1	48
Kg	Sub	Up	Down

HEADER FOR TOOLS DISPLAY STAND

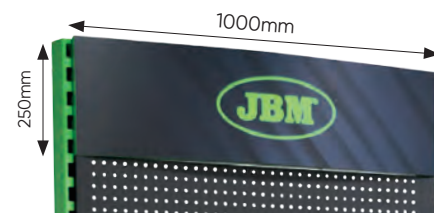

14947 201,50€

8,55	-	1	6
Kg	Sub	Up	Down

LIGHT HEADER FOR TOOLS DISPLAY

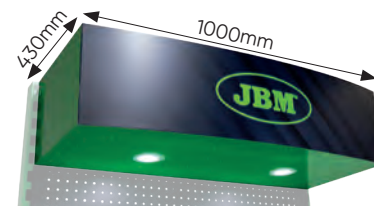

14380 51,00€

5,00	-	1	27
Kg	Sub	Up	Down

TRAY FOR TOOLS DISPLAY 53877

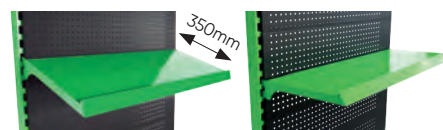

TOOLS DISPLAY + LIGHT HEADER

53878 574,00€

52,15	-	1	-
Kg	Sub	Up	Down



TOOLS DISPLAY + LIGHT HEADER AND DOORS

53879 838,50€

83,25	-	1	-
Kg	Sub	Up	Down



CONTAINS

14945 x1



14380 x1

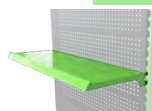

14947 x1



11318 x20



CONTAINS

14945 x1



14948 x1



11318 x20



14996 x1



14947 x1

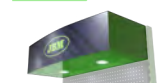

14996 65,00€

5,00	-	1	33
Kg	Sub	Up	Down

TRAY FOR TOOLS DISPLAY WITH DOOR

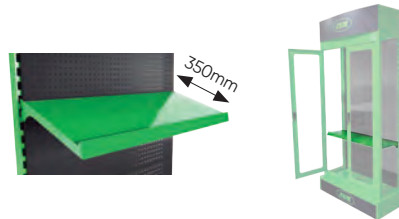

14948 251,50€

31,10	-	1	40
Kg	Sub	Up	Down

SET OF 2 DOORS FOR TOOLS DISPLAY

14945 303,50€

37,80	-	1	14
Kg	Sub	Up	Down

TOOLS DISPLAY



TRAY

14622

17,00€

FOR REF. 60001, 60003, 60004, 60020

0,95	-	10	360
Kg	sub	ft	ft

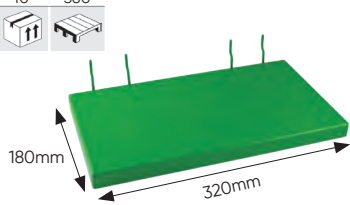

14624

17,00€

FOR REF. 60007, 60010, 60011

0,65	-	10	300
Kg	sub	ft	ft

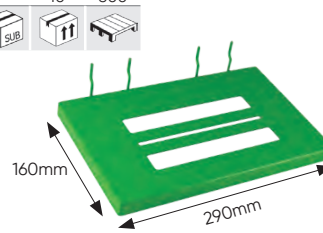

HOOKS

14626

7,00€

FOR REF. 60023

0,10	-	10	-
Kg	sub	ft	ft

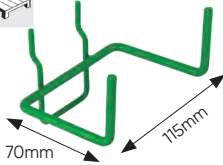

14623

8,00€

FOR REF. 60005, 60006, 60018

0,10	-	10	800
Kg	sub	ft	ft

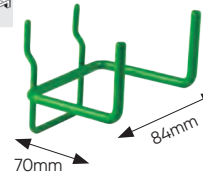

HOOKS

WITH ONE TIP

11318

2,50€

0,04	20	600	-
Kg	sub	ft	ft



WITH CLOSED TIP

51315

2,50€

0,02	20	320	44800
Kg	sub	ft	ft

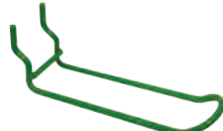

HANGER FOR REF. 60008, 60009

14625

14,00€

0,50	-	10	700
Kg	sub	ft	ft

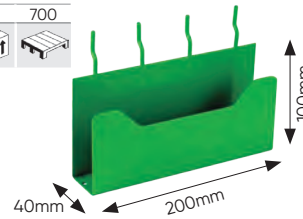

FOR PNEUMATIC TOOLS

14034

9,00€

0,20	20	80	1920
Kg	sub	ft	ft



PNEUMATIC TOOL DISPLAY

53492

380,00€

TOOLS NOT INCLUDED

13,00	-	1	7
Kg	sub	ft	ft



HANGING RAIL

METEXP

62,00€

6,00	-	1	25
Kg	sub	ft	ft



VAT not included

SEPARATION POSTS WITH RETRACTABLE TAPE

53914 75,00€

8.50	-	5	90
Kg	sub	ff	



- Material: Steel
- Tube diameter: 63mm
- Base diameter: 320mm
- Height: 910mm

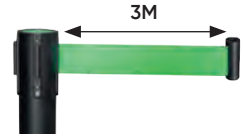

- 4-way tape output
- Tape length: 3m
- Tape width: 48mm

4-WAY TAPE OUTPUT

BOX FOR SPARE HAND-TOOLS

REF.	cm	Kg	ff	€
14922	14,5x9x10	0,10	100	0,84€
14923	17,5x9x7	0,10	100	0,84€
14924	24x11x7	0,10	100	0,84€
14925	31,5x13x4	0,10	100	0,84€
14926	32x8,5x7	0,10	100	1,05€



JBM WARRANTY SEAL

14807 11,00€

0.45	6	24	864
Kg	sub	ff	

- 75mm wide x 125m long
- Made of polypropylene
- Solvent adhesive
- Thickness: 28 micron



PROMOTIONAL CHRISTMAS CARDBOARD BOX

REF.	cm	Kg	ff	€
14976	80x31x61	2,20	1 80	18,84€
15056	40x30x61	1,60	1 70	11,70€
13717	76x14x29	0,90	1 200	7,65€
14083	80x28x49	1,80	1 100	13,20€



14083



13717



14976



15056



CARDBOARD BOX JBM



12950

REF.	cm	Kg	ff	€
11330	19x10x11	0,05	50 4.200	0,57€
12952	40x30x20	0,40	30 360	1,92€
15051	40x32x30	0,40	20 160	1,92€
14974	54x24x40	0,65	20 150	2,28€
13217	57x30x25	0,55	15 150	1,31€
12950	60x40x30	0,80	15 75	3,45€



14189

14507

REF.	CHARACTERISTICS	Kg	ff	€
14189	American pallet box triple channel 120x80x100cm	10	1 40	52,00€
14507	European pallet box 120x98x80cm	8	1 40	50,00€

LEGEND



GENERAL CHARACTERISTICS

Item weight in kilograms	Number of items per subbox	Number of items per exhibitor	Number of items per bag	Number of items per box	Number of bags per box	Number of items per pallet	Presented in blister
Magnetized	Weight that the magnet supports	Noise level (decibels)	Weight	Zoom	Bluetooth connection	USB connection	

MATERIALS

Wood	Steel	PVC	Crom	Brass	Copper	Neodymium	Aluminum
Nylon	Polypropylene	Masonery	Zinc	Chromium Vanadium	CrMo		



TOOLS

Robertson socket	12-point socket	Hexagonal socket	XZN socket tip	Twist socket	Spline socket	Slotted tip	Ribe tip
Phillips tip	Double phillips tip	Torq.	Torx tamper proof tip	Torx tamper proof tip - XZN	Torx tip	Tri-wing	5-point TS bits
12-point tip	H type	Allen	Butterfly bit	Allen bit	Allen	Straight end	Round end



PNEUMATIC PRODUCTS

Revolutions per minute (general)	Revolutions per minute (onwards)	Revolutions per minute (inverse)	Newton-metro(Nm) / Kilograms(Kg)	Pound per square inch	Pressure unit (Bar)	Air entrance	Rear exit
Rear exit de 360°	Front exit	Front exit	Front exit	Measures	Ergonomic handle	Disk orbit	Disk diameter
Size drill	Drill entry measure	Movements in 360°	No. of speeds	Horsepower	Double hammer mechanism	90° angle	

NUMERICAL INDEX

REF.	Pg.	RRP	REF.	Pg.	RRP	REF.	Pg.	RRP	REF.	Pg.	RRP
10054	192	2,90€	10569	38	4,50€	10674	205	9,50€	10831	329	0,20€
10055	192	3,90€	10570	38	4,50€	10675	205	9,50€	10832	329	0,20€
10485	193	8,10€	10571	38	5,00€	10720	280	24,50€	10833	329	0,20€
10486	193	8,00€	10579	38	3,00€	10721	280	19,00€	10834	329	0,25€
10494	193	6,50€	10580	38	3,10€	10722	280	24,50€	10835	329	0,25€
10495	193	3,00€	10581	38	3,40€	10723	280	29,50€	10836	329	0,30€
10496	193	3,00€	10582	38	4,00€	10724	280	29,50€	10837	329	0,30€
10497	193	3,00€	10583	38	4,15€	10731	79	17,60€	10838	329	0,30€
10498	193	3,00€	10584	38	5,05€	10732	79	18,70€	10839	329	0,40€
10499	193	3,00€	10585	38	6,75€	10733	79	17,50€	10840	329	0,35€
10500	193	3,00€	10586	38	7,60€	10735	79	20,30€	10868	333	0,30€
10501	193	8,10€	10587	38	9,80€	10750	124	13,00€	10869	333	0,30€
10502	193	3,50€	10588	38	10,50€	10751	124	15,00€	10870	333	0,45€
10527	36	13,10€	10589	38	2,00€	10761	280	16,00€	10871	333	0,30€
10528	36	15,80€	10590	38	2,40€	10762	280	23,50€	10872	333	0,40€
10529	36	18,00€	10591	40	2,50€	10766	124,130	1,59€	10873	333	0,45€
10530	36	28,70€	10592	40	2,55€	10767	252	21,00€	10874	333	0,30€
10531	37	3,00€	10593	40	3,15€	10768	261	113,00€	10875	333	0,40€
10532	37	2,70€	10594	40	3,20€	10769	261	21,00€	10876	333	0,45€
10533	37	3,00€	10595	40	3,35€	10770	261	6,00€	10877	327	0,25€
10534	37	3,25€	10596	40	4,25€	10772	328	0,05€	10878	327	0,30€
10535	37	3,50€	10597	40	4,50€	10773	328	0,10€	10879	327	0,20€
10536	37	3,65€	10598	40	4,60€	10774	328	0,10€	10880	327	0,20€
10537	37	3,90€	10599	40	6,00€	10775	328	0,15€	10881	327	0,25€
10538	37	4,30€	10600	40	6,25€	10776	328	0,20€	10882	325	0,25€
10539	37	4,75€	10601	40	6,50€	10777	328	0,20€	10883	325	0,25€
10540	37	5,25€	10602	40	7,05€	10778	328	0,35€	10884	325	0,25€
10541	37	5,55€	10603	40	2,10€	10779	326,328	0,05€	10885	335	0,20€
10542	37	5,85€	10604	40	2,25€	10780	326,328	0,05€	10886	335	0,20€
10543	37	7,00€	10617	36	14,10€	10781	326,328	0,05€	10887	335	0,25€
10544	37	8,10€	10618	36	15,10€	10782	328	0,05€	10888	335	0,30€
10545	37	9,75€	10619	36	15,70€	10783	328	0,05€	10889	335	0,30€
10546	37	11,60€	10620	36	16,20€	10784	326	0,05€	10890	335	0,35€
10547	37	13,50€	10621	36	9,50€	10785	326,328	0,10€	10891	335	0,25€
10548	37	1,75€	10622	36	10,00€	10786	326,328	0,15€	10892	335	0,30€
10549	37	2,00€	10623	36	12,60€	10787	328	0,05€	10893	335	0,25€
10550	37	2,15€	10624	36	13,50€	10788	328	0,05€	10894	335	0,20€
10551	37	2,15€	10625	36	15,70€	10789	328	0,05€	10895	335	0,20€
10552	34	7,10€	10626	36	17,80€	10790	328	0,05€	10896	335	0,30€
10553	34	7,35€	10627	39	2,80€	10791	328	0,05€	10897	335	0,30€
10554	34	7,50€	10628	39	3,10€	10792	328	0,05€	10898	335	0,30€
10555	34	7,80€	10629	39	3,65€	10793	325	0,25€	10899	335	0,30€
10556	34	8,10€	10630	39	3,90€	10794	325	0,40€	10900	335	0,30€
10557	34	8,10€	10631	39	4,20€	10795	325	0,60€	10901	335	0,25€
10558	34	9,35€	10632	39	5,30€	10805	326	0,10€	10902	335	0,30€
10559	34	9,50€	10633	39	6,60€	10812	326	0,30€	10905	335	0,25€
10560	34	10,60€	10634	39	7,80€	10813	326	0,30€	10906	335	0,25€
10561	34	11,00€	10635	39	8,15€	10823	329	0,20€	10907	335	0,25€
10562	34	12,30€	10636	39	8,80€	10824	329	0,20€	10908	335	0,30€
10563	34	12,50€	10637	39	12,10€	10825	329	0,20€	10909	335	0,30€
10564	38	2,50€	10638	39	12,70€	10826	329	0,40€	10910	335	0,30€
10565	38	3,50€	10639	261	10,90€	10827	329	0,60€	10911	335	0,30€
10566	38	3,50€	10671	270	15,20€	10828	329	0,45€	10912	335	0,25€
10567	38	3,50€	10672	205	9,50€	10829	329	0,20€	10913	335	0,30€
10568	38	4,00€	10673	205	9,50€	10830	329	0,20€	10914	335	0,25€

REF.	Pg.	RRP	REF.	Pg.	RRP	REF.	Pg.	RRP	REF.	Pg.	RRP
10915	334,335	0,25€	11152	155	57,00€	11318	353,352	2,50€	11891	313	0,50€
10916	335	0,30€	11153	154,155	23,40€	11323	267	16,00€	11892	270	12,50€
10917	334,335	0,30€	11154	155	21,70€	11324	124	17,50€	11893	190	7,00€
10918	334,335	0,30€	11155	154,155	24,40€	11325	124	17,50€	11894	190	7,00€
10919	334,335	0,30€	11156	155	28,90€	11328	298	4,00€	11895	190	8,65€
10920	334,335	0,25€	11157	155	26,60€	11329	276	564,00€	11896	190	8,80€
10921	334,335	0,30€	11158	154,155	28,50€	11330	354	0,57€	11897	172	155,00€
10923	119	1,10€	11159	155	30,30€	11360	28	2,60€	11900	310	3,50€
10925	252	18,00€	11160	155	27,00€	11362	28	5,20€	11901	310	2,50€
10945	298	2,30€	11161	155	32,30€	11363	28	3,90€	11902	310	3,50€
10953	195	12,50€	11162	155	29,10€	11364	28	4,50€	11903	310	5,00€
10955	178	11,00€	11163	155	32,70€	11365	28	9,40€	11904	310	2,00€
10961	120	13,00€	11164	155	30,70€	11374	178	5,50€	11905	310	1,50€
10962	264	85,00€	11165	155	34,60€	11375	178	6,50€	11906	310	8,50€
10964	172	9,00€	11166	155	30,90€	11376	178	5,50€	11907	310	11,00€
10965	172	6,00€	11167	155	38,00€	11377	178	5,50€	11938	152	47,00€
10966	172	13,50€	11168	155	41,00€	11378	178	6,50€	11939	261	63,00€
10993	269	117,00€	11169	155	39,20€	11379	178	6,00€	11945	54	7,00€
11093	120	4,00€	11170	155	40,00€	11380	178	6,50€	11946	54	4,50€
11095	280	31,00€	11171	155	51,00€	11381	178	6,50€	11947	54	19,00€
11098	280	57,00€	11172	155	48,00€	11382	178	6,00€	11950	269	18,00€
11100	279	24,30€	11173	155	47,00€	11383	178	6,00€	11956	137	5,50€
11101	279	154,00€	11174	155	47,00€	11384	178	6,00€	11957	137	5,50€
11102	279	6,60€	11175	155	49,00€	11385	178	5,50€	11959	168	10,50€
11103	124	6,00€	11176	155	56,00€	11386	178	6,00€	11960	309,310	1,50€
11106	180	3,00€	11177	155	55,00€	11387	178	6,00€	11962	150,154	7,50€
11107	120	4,50€	11178	155	53,00€	11388	178	6,00€	11963	154	9,00€
11121	150,155	4,10€	11179	155	65,00€	11389	178	6,00€	11964	154	12,50€
	150,155	5,45€	11180	155	59,00€	11390	178	6,00€	11965	154	16,00€
11123	150,155	6,50€	11181	155	65,00€	11391	178	6,50€	11966	154	18,00€
11124	156	7,65€	11182	155	73,00€	11392	178	6,00€	11967	154	18,00€
11125	156	8,50€	11183	155	70,00€	11393	178	6,00€	11971	85	3,10€
11126	155	11,20€	11184	155	87,00€	11394	178	6,00€	11974	278	1,80€
11127	155	13,80€	11185	155	97,00€	11541	161	11,00€	11975	278	1,80€
11128	155	14,10€	11186	155	91,00€	11542	161	11,00€	11976	278	1,80€
11129	155	14,10€	11187	155	98,00€	11543	161	11,00€	11977	278	1,80€
11130	155	13,10€	11188	155	103,00€	11544	161	7,00€	11978	278	1,80€
11131	155	14,10€	11189	155	121,00€	11545	161	11,00€	11979	278	1,80€
11132	155	13,70€	11190	155	138,00€	11546	161	12,00€	11980	278	1,80€
11133	155	12,00€	11191	155	149,00€	11547	161	12,00€	11981	278	1,80€
11134	155	15,00€	11192	155	152,00€	11613	155	11,00€	11982	278	1,80€
11135	155	17,20€	11193	155	183,00€	11614	155	13,00€	11983	278	1,80€
11136	155	15,30€	11194	155	176,00€	11615	155	14,20€	11989	120	2,00€
11137	155	18,20€	11195	150,155	3,70€	11616	155	18,10€	11990	150,152	15,30€
11138	155	18,00€	11212	46	5,00€	11617	155	18,70€	11992	276	65,00€
11139	155	18,80€	11213	46	10,60€	11618	155	18,80€	11994	79	33,00€
11140	155	20,40€	11214	46	12,50€	11619	155	19,50€	11996	79	48,00€
11141	155	18,60€	11219	276	659,00€	11621	155	359,00€	11997	79	39,00€
11142	155	21,30€	11244	40	8,50€	11622	155	399,00€	11998	79	49,00€
11143	155	26,40€	11245	40	9,15€	11623	155	489,00€	12009	139	11,00€
11144	155	33,30€	11246	40	12,40€	11624	155	189,00€	12022	167,270	33,70€
11145	155	35,30€	11247	40	14,00€	11625	155	282,00€	12029	30,196	5,50€
11146	155	37,30€	11248	40	14,60€	11628	151	9,50€	12030	30,196	6,50€
11147	155	41,00€	11249	40	26,50€	11867	256	9,00€	12031	150,151,155	15,00€
11148	155	47,00€	11313	81	54,00€	11878	211	4,10€	12032	267	7,50€
11149	155	45,00€	11314	151	13,00€	11879	211	5,10€	12044	255	147,00€
11150	155	55,00€	11315	151	8,50€	11880	211	10,50€	12046	264	385,00€
11151	155	57,00€	11316	151	8,50€	11890	313	0,55€	12055	294	20,00€

REF.	Pg.	RRP	REF.	Pg.	RRP	REF.	Pg.	RRP	REF.	Pg.	RRP
12056	252	57,00€	12974	175	21,00€	13049	338	2,05€	13108	336	1,90€
12060	47	2,50€	12975	175	23,00€	13050	339	1,55€	13109	336	2,90€
12061	155	9,50€	12977	208	36,50€	13051	339	1,50€	13110	336	1,85€
12062	150, 151, 155	9,50€	12984	155	379,00€	13053	339	2,80€	13111	336	1,20€
12063	150, 151, 155	9,50€	12987	142	1,50€	13054	339	2,35€	13112	336	1,65€
12064	155,150	9,00€	12988	148	12,00€	13055	339	3,00€	13113	336	2,20€
12065	150, 151, 155	9,00€	12995	54	7,00€	13056	339	1,55€	13114	336	2,20€
12066	150, 151, 155	9,00€	12996	54	7,00€	13057	339	1,50€	13115	336	2,50€
12067	155,150	9,50€	12997	54	7,50€	13058	339	2,20€	13116	340	5,45€
12068	150, 151, 155	9,50€	12998	54	9,00€	13059	339	2,35€	13117	340	3,65€
12069	150, 151, 155	9,50€	12999	54	9,50€	13060	339	1,60€	13118	340	15,90€
12070	150, 151, 155	10,50€	13002	336	1,45€	13061	339	2,65€	13119	340	5,60€
12071	150, 151, 155	11,00€	13003	336	1,70€	13062	339	2,35€	13120	340	5,50€
12072	150, 151, 155	12,00€	13004	336	1,85€	13063	339	1,15€	13121	340	8,75€
12074	150,152	11,50€	13005	336	1,25€	13064	339	2,60€	13122	340	1,95€
12075	150,152	15,50€	13006	336	1,40€	13065	339	2,00€	13123	340	5,35€
12200	208	14,50€	13007	336	1,30€	13066	339	2,25€	13124	340	8,20€
12889	270	12,00€	13008	336	2,25€	13067	339	2,55€	13125	340	5,95€
12901	185	5,20€	13009	336	1,65€	13068	338	2,85€	13126	340	1,55€
12902	309	4,50€	13010	336	1,75€	13069	338	4,55€	13127	340	5,60€
12908	309	4,50€	13011	336	1,15€	13070	338	2,15€	13128	337	1,85€
12910	309	4,40€	13012	336	1,80€	13071	338	2,05€	13129	337	2,00€
12915	309	12,40€	13013	336	1,75€	13072	338	2,75€	13130	337	3,75€
12920	309	7,80€	13014	336	1,45€	13073	338	2,10€	13131	337	3,45€
12923	309	9,50€	13015	336	1,20€	13074	339	4,65€	13132	337	2,65€
12924	309	4,10€	13016	336	1,15€	13075	339	5,35€	13133	337	3,45€
12925	309	10,70€	13017	336	2,60€	13076	339	3,90€	13134	337	3,95€
12926	200	21,50€	13018	336	1,45€	13077	339	2,55€	13135	337	3,45€
12927	200	21,50€	13019	336	1,75€	13078	339	2,55€	13136	337	2,60€
12928	200	22,00€	13020	336	1,70€	13079	339	3,35€	13137	337	2,25€
12929	200	23,00€	13021	336	1,30€	13080	338	1,75€	13138	337	2,85€
12930	200	23,50€	13022	336	2,10€	13081	338	2,30€	13139	337	3,85€
12931	153	7,50€	13023	336	1,50€	13082	338	1,35€	13140	337	2,65€
12932	153	7,50€	13024	336	2,45€	13083	338	1,50€	13141	337	1,80€
12933	153	8,00€	13025	336	1,50€	13084	338	2,10€	13142	337	3,10€
12934	153	7,50€	13026	341	1,55€	13085	338	1,60€	13143	337	1,95€
12935	153	8,00€	13027	341	1,85€	13086	338	1,25€	13144	337	2,20€
12936	153	8,50€	13028	341	1,45€	13087	338	3,30€	13145	337	3,85€
12937	150,152	9,50€	13029	341	1,65€	13088	338	2,40€	13146	337	4,50€
12938	153	10,00€	13030	341	2,80€	13089	338	1,70€	13147	337	3,10€
12939	153	10,00€	13031	341	1,85€	13090	338	1,70€	13148	337	3,30€
12940	153	10,00€	13032	341	2,00€	13091	338	1,25€	13149	337	3,10€
12941	153	10,00€	13033	341	1,60€	13092	340	1,65€	13150	337	2,25€
12942	153	10,00€	13034	341	2,65€	13093	340	2,95€	13151	337	5,35€
12943	153	10,00€	13035	341	1,65€	13094	340	1,50€	13152	337	3,05€
12944	153	10,00€	13036	341	1,40€	13095	340	1,20€	13153	337	3,10€
12945	153	10,50€	13037	341	2,10€	13096	340	1,70€	13154	337	3,20€
12950	354	3,45€	13038	338	1,40€	13097	340	1,20€	13155	337	5,60€
12952	354	1,92€	13039	338	1,65€	13098	340	1,65€	13156	337	3,30€
12954	335	0,25€	13040	338	1,80€	13099	340	2,75€	13157	337	3,85€
12955	160	27,80€	13041	338	1,55€	13100	340	1,20€	13158	337	3,75€
12956	160	45,00€	13042	338	1,95€	13101	340	1,50€	13159	337	3,20€
12957	160	27,80€	13043	338	1,20€	13102	340	1,60€	13160	337	5,00€
12958	160	27,80€	13044	338	1,55€	13103	340	1,80€	13161	337	3,55€
12959	160	27,80€	13045	338	1,20€	13104	336	1,90€	13162	337	2,60€
12960	160	27,80€	13046	338	1,55€	13105	336	2,50€	13163	337	2,80€
12961	160	27,80€	13047	338	1,45€	13106	336	2,00€	13217	354	1,31€
12973	310	1,00€	13048	338	2,20€	13107	336	2,15€	13226	49	4,50€

REF.	Pg.	RRP	REF.	Pg.	RRP	REF.	Pg.	RRP	REF.	Pg.	RRP
13227	49	4,50€	13497	35	7,50€	13817	138	17,00€	13961	330	9,25€
13228	49	4,50€	13498	35	8,50€	13818	138	20,50€	13962	330	1,76€
13229	49	4,50€	13499	139	12,50€	13822	329	11,00€	13963	330	12,40€
13230	49	4,50€	13500	139	12,90€	13823	329	6,00€	13964	330	15,00€
13231	49	4,50€	13667	49,79	17,60€	13824	329	8,00€	13965	330	1,50€
13232	49	4,50€	13668	79	18,70€	13825	329	11,50€	13966	330	12,90€
13234	255	224,50€	13669	57	18,00€	13826	329	13,00€	13967	330	4,65€
13235	327	0,15€	13672	267	220,00€	13827	329	15,00€	13968	349	1,35€
13236	327	0,15€	13674	50,327	0,50€	13828	329	11,50€	13969	181	19,00€
13237	327	0,15€	13675	50,327	0,50€	13829	329	10,50€	13982	252	4,00€
13238	327	0,20€	13676	50,327	0,50€	13830	329	10,50€	14004	153	9,50€
13239	327	0,20€	13677	50,327	0,50€	13831	329	12,60€	14005	153	10,50€
13240	327	0,40€	13678	50,327	0,50€	13832	329	13,00€	14006	153	9,50€
13241	327	0,55€	13680	152	15,50€	13833	329	9,00€	14007	153	9,50€
13243	349	12,50€	13681	152	15,50€	13836	260	9,00€	14008	153	9,50€
13244	349	12,50€	13682	152	15,50€	13839	120	8,50€	14009	153	9,50€
13245	349	12,50€	13683	152	15,50€	13842	160	8,50€	14010	153	11,00€
13447	36	16,50€	13684	152	15,50€	13843	160	7,00€	14011	153	11,00€
13448	36	17,50€	13685	152	15,50€	13844	160	9,00€	14013	138	3,50€
13449	36	20,00€	13686	152	15,50€	13845	160	8,00€	14014	253	6,00€
13450	36	23,00€	13687	152	15,50€	13853	260	122,00€	14015	253	6,00€
13451	36	28,00€	13688	152	15,50€	13856	180	7,80€	14016	253	6,00€
13452	36	29,50€	13689	152	15,50€	13859	154	16,00€	14026	54	5,50€
13453	34	9,00€	13704	204	21,00€	13870	265	82,00€	14027	54	5,60€
13454	34	9,50€	13707	61	14,00€	13874	154	17,50€	14028	54	7,00€
13455	34	10,50€	13708	61	14,00€	13875	154	18,50€	14029	54	8,50€
13456	34	11,50€	13709	61	14,00€	13876	154	18,50€	14030	54	9,50€
13457	34	12,00€	13710	61	14,00€	13877	154	18,50€	14031	115,120	7,90€
13460	34	15,00€	13712	61	14,00€	13879	314	1,38€	14032	120	12,00€
13462	34	17,00€	13717	354	7,65€	13880	314	1,50€	14033	120	4,50€
13463	35	5,30€	13723	155	18,50€	13923	79	7,45€	14034	353	9,00€
13464	35	5,30€	13724	155	19,20€	13929	346	3,45€	14049	63	8,00€
13465	35	5,55€	13725	155	19,20€	13930	148	1,50€	14050	63	10,50€
13466	35	5,55€	13726	155	19,00€	13931	148	2,50€	14051	63	18,00€
13467	35	6,00€	13727	155	18,70€	13932	148	2,50€	14052	63	19,50€
13468	35	6,25€	13728	155	18,50€	13933	148	2,00€	14059	73	62,00€
13469	35	6,25€	13729	155	22,00€	13934	148	2,50€	14060	73	65,00€
13470	35	6,60€	13730	155	22,00€	13935	148	2,50€	14061	73	93,00€
13471	35	6,90€	13731	155	21,60€	13936	148	3,50€	14062	73	100,00€
13472	35	7,25€	13732	155	21,60€	13937	148	4,00€	14063	73	119,00€
13473	35	8,10€	13733	155	24,90€	13938	148	3,50€	14064	73	39,50€
13474	35	8,70€	13734	155	25,70€	13939	148	4,00€	14068	260	13,00€
13475	35	9,10€	13735	155	25,80€	13945	330	7,40€	14069	260	13,00€
13476	35	9,60€	13736	155	25,90€	13946	330	6,70€	14070	260	116,00€
13477	35	9,85€	13738	314	3,50€	13947	330	5,85€	14071	260	21,50€
13478	35	12,20€	13739	314	5,50€	13948	330	5,00€	14072	260	21,50€
13479	35	13,10€	13740	314	5,50€	13949	330	6,50€	14073	260	128,00€
13480	35	15,50€	13741	313	21,00€	13950	330	7,80€	14075	148	2,00€
13481	35	15,80€	13745	155	25,20€	13951	330	5,15€	14076	148	1,50€
13482	35	22,10€	13746	155	25,40€	13952	330	10,90€	14077	148	4,50€
13483	35	25,50€	13747	155	25,40€	13953	330	8,00€	14078	148	4,00€
13484	35	27,20€	13748	155	24,90€	13954	330	12,70€	14081	276	12,60€
13491	35	5,30€	13805	310	10,50€	13955	330	4,95€	14083	354	13,20€
13492	35	5,35€	13806	310	10,50€	13956	330	4,30€	14090	267	103,00€
13493	35	5,50€	13809	148	18,50€	13957	330	9,70€	14103	164	32,40€
13494	35	6,00€	13810	148	20,50€	13958	330	5,45€	14104	164	32,40€
13495	35	6,40€	13813	163	7,00€	13959	330	10,10€	14105	164	32,40€
13496	35	6,60€	13814	163	11,00€	13960	330	9,65€	14106	164	32,40€

REF.	Pg.	RRP	REF.	Pg.	RRP	REF.	Pg.	RRP	REF.	Pg.	RRP
14107	164	32,40€	14192	148	4,00€	14365	344	1,90€	14432	342	1,45€
14108	164	32,40€	14193	148	4,00€	14366	344	1,45€	14434	342	1,60€
14109	276	29,00€	14195	147	4,00€	14367	344	1,30€	14435	342	1,45€
14110	276	110,00€	14196	147	4,00€	14368	344	1,45€	14436	342	1,70€
14114	79	19,30€	14197	147	4,50€	14369	344	4,95€	14437	342	1,45€
14118	302	26,00€	14198	147	4,00€	14370	344	3,00€	14438	342	1,35€
14120	132	22,00€	14199	147	4,00€	14371	344	3,00€	14439	342	1,75€
14121	132	26,00€	14200	147	4,50€	14372	344	1,20€	14440	342	1,75€
14122	133	34,00€	14201	147	4,00€	14373	344	1,35€	14441	342	1,65€
14123	133	33,00€	14202	147	4,00€	14374	344	1,70€	14442	342	1,45€
14124	135	20,50€	14203	147	4,50€	14375	344	1,85€	14443	342	1,45€
14125	135	19,50€	14204	147	1,50€	14376	344	2,60€	14444	342	1,90€
14126	136	54,00€	14205	147	1,50€	14377	344	1,90€	14445	342	1,45€
14127	135	32,50€	14206	147	1,50€	14378	344	1,90€	14446	342	2,80€
14128	136	13,50€	14207	147	1,50€	14379	344	1,45€	14447	341,342	1,45€
14129	135	12,50€	14208	147	1,50€	14380	352	51,00€	14448	342	2,05€
14130	134	21,00€	14209	147	1,50€	14381	344	1,70€	14449	341,342	2,20€
14131	134	24,00€	14211	192	11,00€	14382	344	1,85€	14450	342	2,15€
14132	135	21,50€	14212	192	12,00€	14383	344	1,35€	14451	342	2,15€
14133	136	16,50€	14213	192	12,00€	14384	344	2,10€	14452	342	2,55€
14134	136	17,50€	14214	192	14,00€	14387	343	1,45€	14453	342	3,05€
14135	137	12,50€	14286	139,161	2,99€	14388	343	2,05€	14455	342	2,10€
14136	138	12,00€	14287	139,161	2,99€	14389	343	1,25€	14456	342	1,35€
14137	138	131,00€	14288	139,161	6,00€	14390	343	1,35€	14457	342	1,70€
14141	73	105,00€	14289	139,161	6,10€	14391	343	2,15€	14458	341	1,70€
14142	73,175	109,00€	14291	269	87,00€	14392	343	1,35€	14459	341	1,45€
14143	73	124,00€	14296	66,67,68, 69,73,74,76	118,00€	14393	343	1,50€	14460	341	1,15€
14144	73	304,00€	14297	66,67,68, 69,74,76	87,00€	14395	343	1,65€	14461	341	1,35€
14145	272	8,50€	14298	66,67,68, 69,74,76	51,50€	14396	343	1,20€	14462	341	1,65€
14146	272	8,00€	14299	66,67,68, 69,74,76	87,00€	14397	343	1,45€	14463	341	1,65€
14147	272	25,00€	14300	207	19,00€	14398	343	1,30€	14464	341	1,50€
14148	272	25,00€	14301	207	19,00€	14399	343	1,90€	14465	341	2,00€
14153	134	20,50€	14314	147	5,00€	14402	343	1,50€	14466	341	1,65€
14154	139	42,00€	14315	147	4,50€	14404	343	2,10€	14468	341	1,30€
14157	138,210	8,30€	14330	139	3,50€	14405	343	1,45€	14469	341	1,45€
14158	138,210	9,95€	14336	134	58,00€	14406	343	1,55€	14471	341	1,90€
14159	138,210	12,60€	14340	191	10,50€	14408	343	1,45€	14472	341	1,35€
14160	138,210	12,80€	14341	191	10,50€	14409	343	1,35€	14473	251	46,00€
14161	138,210	13,70€	14342	191	10,50€	14410	343	1,85€	14474	341	1,50€
14162	139	25,50€	14343	191	10,50€	14411	343	1,70€	14475	341	1,65€
14163	139	25,50€	14344	191	11,00€	14412	343	1,70€	14476	341	2,05€
14164	139	25,50€	14345	191	11,00€	14413	343	3,25€	14477	341	2,45€
14165	132	26,50€	14346	191	11,00€	14414	343	1,70€	14478	341	4,05€
14167	62	2,50€	14347	348	36,50€	14415	343	1,70€	14479	341	1,65€
14168	145	7,00€	14348	186	12,50€	14416	343,344	1,25€	14480	341	2,05€
14169	147	3,00€	14349	186	20,50€	14419	343	1,95€	14481	341	1,70€
14172	151	8,50€	14350	343,344	1,80€	14420	343	1,50€	14507	354	50,00€
14173	151	9,50€	14351	344	1,65€	14421	343	2,45€	14534	144	16,50€
14177	151	9,50€	14352	344	1,30€	14422	342	1,50€	14560	144	8,80€
14178	151	9,50€	14353	344	2,10€	14423	342	3,55€	14561	144	8,80€
14179	60	8,50€	14354	80	14,00€	14424	342	1,85€	14563	209	18,00€
14180	60	7,90€	14355	344	1,70€	14425	342	2,05€	14564	161	9,20€
14183	44	31,00€	14356	344	1,90€	14426	342	1,90€	14565	161	26,70€
14187	208	6,00€	14357	344	1,90€	14427	342	1,20€	14566	161	16,70€
14188	141	0,50€	14358	343,344	1,70€	14428	342	1,40€	14567	161	38,00€
14189	354	52,00€	14359	341,344	1,05€	14429	342	1,80€	14568	161	9,20€
14190	148	2,00€	14364	344	1,90€	14430	342	2,25€	14569	161	9,20€
14191	148	2,00€				14431	342	1,45€	14570	161	4,05€

REF.	Pg.	RRP	REF.	Pg.	RRP	REF.	Pg.	RRP	REF.	Pg.	RRP
14571	161	9,20€	14660	94	83,00€	14733	150,155	4,30€	14838	93,109	3,40€
14573	161	4,05€	14661	94	9,00€	14734	150,155	5,40€	14839	93,109	4,70€
14578	80	12,50€	14662	94	2,50€	14735	150	6,50€	14840	93,109	3,35€
14580	80	41,00€	14663	94	2,50€	14736	151,155	5,00€	14841	93,109	2,58€
14583	132	6,00€	14664	95	100,00€	14737	151,155	5,00€	14842	93,109	9,50€
14589	267	2,50€	14665	95	8,80€	14738	155	5,50€	14843	110	0,50€
14594	207,331	2,00€	14666	95	97,00€	14739	155	5,50€	14844	110	0,50€
14595	207,331	1,50€	14667	95	8,80€	14740	155	5,55€	14845	110	0,50€
14596	207,331	2,00€	14668	95	7,70€	14741	155	5,55€	14846	110	0,50€
14597	207,331	7,60€	14670	95	4,50€	14742	155	5,55€	14847	110	0,50€
14598	207,331	17,80€	14671	96	44,00€	14743	155	5,15€	14848	110	0,50€
14599	207,331	4,50€	14672	96	5,00€	14744	155	5,35€	14849	110	1,00€
14600	207,331	9,50€	14674	96	73,00€	14745	155	6,25€	14850	110	1,00€
14601	207,331	11,00€	14675	88,90	17,00€	14746	155	6,40€	14851	110	1,00€
14602	207,331	11,00€	14676	88,90	36,50€	14747	155	7,10€	14852	110	1,00€
14611	197	12,00€	14677	88,90	9,00€	14748	155	8,30€	14853	110	1,00€
14612	197	11,00€	14678	88,90	86,00€	14749	28,154	2,00€	14854	110	1,00€
14613	197	13,50€	14679	88,90	9,50€	14750	28,154	2,00€	14855	110	1,00€
14615	261	9,50€	14680	95	17,00€	14751	28,154	4,00€	14856	110	1,00€
14616	266	96,00€	14681	95	108,00€	14752	28,154	4,00€	14857	110	1,50€
14618	133	19,00€	14682	95	9,00€	14753	129	13,00€	14858	110	1,50€
14622	107,353	17,00€	14683	95	86,00€	14755	272	134,00€	14859	110	1,50€
14623	107,353	8,00€	14684	94	3,00€	14756	272	15,20€	14860	110	2,00€
14624	107,353	17,00€	14685	94	5,00€	14757	272	15,20€	14861	110	2,00€
14625	107,353	14,00€	14686	94	73,00€	14758	272	18,00€	14862	110	2,00€
14626	107,353	7,00€	14687	94	35,00€	14759	272	18,00€	14863	110	2,50€
14628	101	2,50€	14691	97	167,00€	14765	91	97,00€	14864	110	2,50€
14629	101	4,00€	14692	97	5,50€	14766	92	3,15€	14865	110	2,50€
14630	101	22,00€	14693	93	3,50€	14767	92	2,34€	14866	110	3,00€
14631	101	3,50€	14694	93	11,50€	14768	95	28,80€	14867	110	3,00€
14632	101	3,50€	14695	93	4,00€	14769	88,90	37,75€	14868	110	0,55€
14633	132	22,50€	14696	93	18,00€	14770	95	40,00€	14869	110	0,60€
14634	101	36,50€	14697	93	8,00€	14771	146,283	10,50€	14870	110	1,00€
14635	101	10,00€	14698	93	1,00€	14772	146	8,50€	14871	110	1,00€
14636	102	30,00€	14699	93	30,00€	14774	283	10,50€	14872	110	1,00€
14637	91	15,50€	14700	93	2,50€	14775	322	30,50€	14873	110	1,00€
14638	91	7,00€	14701	93	2,50€	14779	135	33,00€	14874	110	1,00€
14639	266	195,00€	14702	93	92,00€	14781	319	9,90€	14875	110	1,50€
14640	91	8,00€	14703	251	13,00€	14783	80	5,50€	14876	110	1,50€
14641	91	18,50€	14706	269	8,90€	14785	270	3,50€	14877	110	1,50€
14642	91	83,00€	14708	261	59,00€	14793	319	12,00€	14878	110	2,00€
14643	92	24,50€	14709	260	122,00€	14802	322	44,00€	14879	110	2,00€
14644	92	8,00€	14710	161	3,50€	14803	322	43,00€	14880	110	2,50€
14645	92	45,00€	14711	161	3,75€	14807	354	11,00€	14881	110	2,50€
14646	92	110,00€	14712	161	4,00€	14808	92	3,05€	14882	110	3,00€
14647	96	3,00€	14713	161	4,25€	14825	109	1,50€	14883	110	3,50€
14648	88,90	106,00€	14714	161	4,50€	14826	109	1,50€	14884	110	3,65€
14649	96	50,00€	14715	161	4,75€	14827	109	2,00€	14885	110	4,00€
14650	96	5,00€	14723	154	18,00€	14828	109	1,50€	14886	110	4,60€
14651	96	86,00€	14724	154	18,50€	14829	109	1,50€	14887	110	5,00€
14652	92	47,00€	14725	154	18,50€	14830	109	1,50€	14888	110	6,00€
14653	92	5,25€	14726	154	17,50€	14831	109	1,50€	14889	110	6,50€
14654	92	104,00€	14727	269	108,00€	14832	109	2,00€	14890	110	7,00€
14655	92	5,95€	14728	150,155	3,80€	14833	109	2,05€	14891	110	7,50€
14656	92	4,50€	14729	150,155	3,80€	14834	109	2,50€	14892	110	8,00€
14657	92	4,50€	14730	150,155	3,80€	14835	109	3,00€	14893	92,112	2,00€
14658	94	45,00€	14731	150,155	3,80€	14836	109	3,50€	14894	112	1,20€
14659	94	5,00€	14732	150,155	3,80€	14837	93,109	3,30€	14895	112	1,90€

REF.	Pg.	RRP	REF.	Pg.	RRP	REF.	Pg.	RRP	REF.	Pg.	RRP
14896	112	2,10€	14962	96	6,50€	15051	354	1,92€	15144	82	30,00€
14897	112	0,88€	14963	96	7,50€	15052	208	3,00€	15145	82	20,45€
14898	112	0,98€	14964	94	8,00€	15053	208	10,50€	15146	82	16,20€
14899	112	0,88€	14965	94	8,50€	15054	208	34,00€	15147	53	5,00€
14900	92,112	0,98€	14966	97	7,50€	15056	354	11,70€	15148	53	5,00€
14901	111	3,60€	14967	93	5,50€	15058	80	7,50€	15149	53	5,00€
14902	111	4,65€	14968	93	6,00€	15059	319	10,00€	15151	101	10,50€
14903	111	5,25€	14970	150	2,50€	15062	319	1,00€	15152	348	160,00€
14904	111	6,85€	14971	150	2,50€	15065	80	6,50€	15153	292	2,50€
14905	111	8,50€	14972	150	3,50€	15068	80	15,20€	15154	292	7,50€
14906	111	10,20€	14973	150	11,50€	15069	80	32,80€	15155	67,77	59,00€
14907	109	0,50€	14974	354	2,28€	15070	75	0,50€	15156	39,77	70,00€
14908	109	0,60€	14975	351	64,00€	15071	74	0,60€	15157	77	42,00€
14909	109	0,80€	14976	354	18,84€	15072	74	0,70€	15158	77	59,00€
14910	109	1,00€	14978	54	7,50€	15073	74	1,00€	15159	77	44,00€
14911	109	1,30€	14979	54	9,00€	15074	74	1,00€	15160	77	42,00€
14912	109	1,55€	14980	54	13,00€	15075	74	1,20€	15161	67,77	62,00€
14913	109	1,90€	14981	54	22,50€	15076	74	3,50€	15162	32,78,289	30,20€
14914	109	2,10€	14982	54	27,50€	15083	75	8,50€	15206	39	15,00€
14915	109	2,65€	14985	96,112	6,00€	15084	75,181	68,00€	15207	39	16,50€
14916	109	2,95€	14986	96,112	4,00€	15085	270	156,00€	15208	39	17,00€
14917	109	3,45€	14987	97,112	8,50€	15093	262	38,00€	15209	39	18,00€
14918	301,320	0,23€	14988	96,112	8,00€	15094	262	39,50€	15227	32	3,50€
14919	301,320	0,45€	14989	96,112	6,00€	15095	262	13,00€	15228	32	4,00€
14920	109	2,50€	14990	97,112	10,50€	15096	262	40,00€	15229	32	5,00€
14922	354	0,84€	14991	95,112	2,00€	15098	104	11,50€	15230	32	5,00€
14923	354	0,84€	14992	178	8,50€	15099	104	5,50€	15231	32	3,50€
14924	354	0,84€	14993	95,112	5,00€	15100	104	70,00€	15232	32	4,00€
14925	354	0,84€	14994	95,112	3,50€	15101	104	11,00€	15233	32	5,00€
14926	354	1,05€	14995	95,112	8,00€	15102	104	40,00€	15234	32	3,00€
14929	264	35,00€	14996	352	65,00€	15103	104	20,50€	15237	277	12,00€
14930	182	9,50€	15001	344	3,00€	15104	104	31,50€	15238	277	5,00€
14931	182	8,00€	15010	214	16,50€	15105	104	30,00€	15239	277	5,50€
14932	182	9,50€	15011	214	18,00€	15106	104	15,00€	15240	277	9,50€
14933	182	9,50€	15012	214	31,50€	15107	105	4,00€	15241	277	65,00€
14934	111	4,25€	15014	92,112	20,00€	15108	105	2,16€	15242	277	2,50€
14935	111	8,45€	15018	75,253	46,00€	15109	105	25,50€	15243	277	4,00€
14936	94	27,50€	15023	80	12,50€	15110	105	6,55€	15244	277	2,00€
14937	253	9,50€	15024	80	15,00€	15111	105	30,40€	15245	277	7,50€
14938	270	42,00€	15025	80	12,50€	15112	105	3,25€	15246	277	108,00€
14939	270	57,00€	15026	80	15,00€	15113	105	11,80€	15247	277	2,50€
14940	270	248,00€	15030	80	8,00€	15114	104	6,00€	15248	277	2,50€
14945	352	303,50€	15033	80	6,00€	15115	104	8,50€	15249	277	5,00€
14946	352	58,00€	15034	80	57,00€	15116	104	29,50€	15250	277	4,50€
14947	352	201,50€	15035	80	8,50€	15117	104	29,50€	15251	277	15,00€
14948	352	251,50€	15036	80	8,50€	15118	104	52,00€	15253	196,202	62,00€
14950	101	6,50€	15037	80	8,00€	15119	104	10,00€	15254	91	12,50€
14951	101	9,50€	15038	80	34,50€	15120	104	6,50€	15255	265	114,00€
14952	101	19,00€	15040	80	12,50€	15121	104	12,00€	15256	348	36,00€
14953	101	8,50€	15041	80	15,00€	15122	35,67,77	74,00€	15257	348	27,50€
14954	92	14,50€	15042	80	7,50€	15123	251	32,00€	15258	348	27,50€
14955	96	7,50€	15043	266	195,00€	15124	102	9,50€	15259	348	18,00€
14956	92	4,40€	15044	266	259,00€	15125	102	23,00€	15260	348	22,50€
14957	92	4,10€	15046	266	47,00€	15126	99	19,50€	15276	98	46,00€
14958	94	22,00€	15047	266	47,00€	15127	99	29,00€	15277	98	9,00€
14959	94	10,00€	15048	266	5,00€	15138	51	10,50€	15278	98	3,50€
14960	95	3,85€	15049	102	37,40€	15139	51	12,00€	15279	98	69,00€
14961	95	3,95€	15050	80	9,50€	15140	51	13,50€	15280	98	91,00€

REF.	Pg.	RRP	REF.	Pg.	RRP	REF.	Pg.	RRP	REF.	Pg.	RRP
15282	253	15,00€	15398	282	75,00€	15500	178	10,00€	15732	70,76	293,50€
15283	253	27,50€	15399	282	117,00€	15501	178	10,00€	15733	70,76	113,00€
15300	309	5,00€	15424	106,281	105,00€	15502	178	10,00€	15734	70,76	288,50€
15305	253	19,50€	15425	106,281	50,00€	15503	178	11,00€	15735	76	38,00€
15306	253	27,50€	15426	106,281	10,00€	15504	178	10,00€	15736	76	488,50€
15307	253	39,60€	15427	106,281	9,00€	15505	178	4,00€	15737	48,78	45,00€
15308	253	7,00€	15428	106,281	238,00€	15506	178	4,00€	15765	101	14,00€
15309	253	17,00€	15429	106,281	23,50€	15507	178	4,50€	15781	272	19,84€
15310	253	11,50€	15430	106,281	83,00€	15508	178	4,50€	15782	272	16,00€
15311	253	11,50€	15431	106,281	241,00€	15509	178	5,00€	15789	350	2.545,00€
15312	253	11,50€	15432	106,281	18,50€	15510	178	5,00€	15799	46,79	28,30€
15313	80	14,00€	15433	106,281	197,00€	15511	178	8,00€	15866	293	32,00€
15315	78	28,20€	15434	106,281	147,00€	15514	67,78	9,35€	15874	249	6,50€
15316	36,77	58,00€	15435	106,281	24,50€	15515	36	15,50€	15905	296	16,50€
15317	309	4,50€	15436	106,281	97,00€	15516	36	19,00€	15906	296	28,50€
15318	253	17,00€	15437	106,281	305,50€	15517	36	22,50€	15907	296	12,00€
15320	98	1,00€	15438	106,281	31,00€	15526	264	48,00€	15908	296	14,50€
15321	98	3,00€	15439	106,281	52,00€	15527	264	276,00€	15909	296	21,50€
15322	98	3,50€	15440	99	33,00€	15528	264	39,00€	15910	296	16,50€
15323	98	24,00€	15454	58,77	35,40€	15530	93	7,50€	15911	296	30,50€
15324	98	18,00€	15460	287	5,00€	15531	93	5,00€	15912	296	35,50€
15325	98	3,50€	15462	105	7,50€	15532	93	98,00€	15913	296	7,50€
15326	98	1,00€	15463	105	114,00€	15533	93	4,50€	15914	296	7,50€
15327	98	5,50€	15464	105	6,50€	15534	93	4,50€	15980	250	55,00€
15328	35	6,00€	15465	105	11,50€	15535	93	3,50€	15981	250	181,00€
15329	35	5,50€	15466	105	6,50€	15536	93	14,50€	15982	250	73,00€
15330	35	5,50€	15467	105	14,00€	15537	93	6,00€	15983	250	11,50€
15331	35	5,50€	15468	105	2,50€	15538	93	17,00€	15984	250	48,00€
15332	35	6,00€	15469	105	9,50€	15539	255	104,00€	16020	37	17,00€
15333	35	6,50€	15470	105	7,50€	15541	77	27,60€	16021	37	19,50€
15334	35	7,00€	15471	105	20,10€	15542	255	45,00€	16022	37	23,00€
15335	35	7,50€	15472	105	19,00€	15550	253	6,00€	16023	37	26,50€
15336	35	8,00€	15473	105	13,70€	15551	253	6,00€	16024	37	34,50€
15337	35	8,50€	15474	105	8,50€	15552	172	181,00€	16025	37	37,50€
15338	35	9,00€	15475	105	8,50€	15553	250	108,00€	16052	120,123	2,09€
15339	35	9,50€	15476	105	11,00€	15564	133	11,90€	16053	120,123	2,85€
15340	349	5,50€	15477	105	5,70€	15631	251	98,00€	16111	79	19,20€
15341	349	5,50€	15478	105	3,60€	15632	34	9,35€	16130	287	290,00€
15342	349	9,00€	15480	255	0,99€	15633	34	9,50€	16138	106	7,45€
15343	349	9,50€	15481	103	4,50€	15634	34	10,60	16139	106	14,20€
15344	349	6,50€	15482	103	4,00€	15635	34	11,00€	16140	106	14,20€
15345	349	10,50€	15483	103	4,00€	15636	34	12,30€	16141	106	4,45€
15346	349	24,00€	15484	103	5,50€	15637	34	12,50€	16142	106	10,80€
15349	349	8,50€	15485	103	4,00€	15681	55,78	134,00€	16143	106	2,06€
15375	161	28,00€	15486	103	9,00€	15671	297	20,50€	16144	106	12,80€
15380	99	169,00€	15487	103	59,00€	15706	55,78	31,00€	16145	106	79,00€
15381	99	5,50€	15488	103	4,00€	15708	58	10,00€	16146	106	4,45€
15382	99	42,00€	15489	103	10,50€	15710	58	10,00€	16147	106	13,00€
15385	122	18,00€	15490	103	4,00€	15719	100	11,00€	16148	106	35,40€
15388	282	33,00€	15491	103	4,00€	15720	100	59,00€	16149	106	38,60€
15389	282	18,50€	15492	103	5,00€	15721	100	46,00€	16150	100	7,90€
15390	282	43,00€	15493	103	4,50€	15722	100	4,25€	16151	89	50,00€
15391	282	13,50€	15494	178	12,50€	15723	100	2,21€	16152	89	25,10€
15392	282	17,50€	15495	178	12,50€	15724	100	2,82€	16153	89	81,00€
15393	282	12,50€	15496	178	11,50€	15725	100	1,86€	16154	89	34,10€
15394	282	26,00€	15497	178	11,00€	15726	100	2,82€	16155	89	34,10€
15395	282	3,50€	15498	178	11,50€	15730	70,76	289,00€	16156	89	12,60€
15396	300	2,04€	15499	178	11,00€	15731	70,76	214,00€	16157	89	59,00€

REF.	Pg.	RRP	REF.	Pg.	RRP	REF.	Pg.	RRP	REF.	Pg.	RRP
16158	128	9,00€	50765	308	0,58€	50935	252	595,00€	51259	193	58,00€
16160	106	3,99€	50766	308	0,68€	50937	204	10,50€	51260	25	37,00€
16161	80	17,50€	50767	308	0,78€	50942	274,288	28,00€	51261	25	36,00€
16162	80	35,10€	50768	308	0,88€	50957	295	22,00€	51262	203	51,00€
16163	80	10,20€	50771	308	0,29€	50959	295,328	12,00€	51262R	203	14,00€
16165	280	2,00€	50774	308	0,57€	50960	295	18,30€	51266	301	28,00€
16166	280	23,50€	50776	308	0,76€	50966	300,317	4,00€	51272	55	7,50€
16167	280	7,00€	50778	308	0,10€	50980	30	22,00€	51277	144	64,00€
16168	280	5,00€	50779	308	0,19€	50982	30	22,00€	51283	174	78,00€
16169	280	1,50€	50780	308	0,29€	50983	27	48,00€	51305	52	28,90€
16170	280	1,50€	50781	308	0,38€	50985	27	59,00€	51306	52	28,10€
16171	280	20,50€	50782	308	0,49€	51017	58	6,80€	51307	52	29,70€
16172	280	22,50€	50783	314	0,58€	51018	58	7,05€	51315	353	2,50€
16173	280	3,00€	50784	308	0,68€	51020	58	6,65€	51318	34	98,00€
16188	80	39,60€	50785	308	0,78€	51021	58	7,05€	51326	119	4,40€
16198	287	5,00€	50786	308	0,88€	51028	154	163,00€	51332	178	98,00€
54294	317	8,80€	50787	214	8,00€	51033	283	98,00€	51333	28	18,00€
50400	169	168,00€	50788	214	14,50€	51035	82	799,00€	51336	151	29,30€
50403	169	98,00€	50789	214	29,00€	51050	295	285,00€	51337	182	50,00€
50409	170	26,00€	50790	214	29,00€	51051	295	34,80€	51338	203	53,00€
50410	169	168,00€	50792	188	105,00€	51055	308	0,98€	51338R	203	14,00€
50431	129	3,80€	50793	188	94,00€	51056	308	0,75€	51340	245	39,30€
50517	293	129,00€	50797	256,292	490,00€	51059	175	99,00€	51341	142,214	35,00€
50518	293	169,00€	50807	207,332	38,00€	51119	187	62,00€	51347	212	9,90€
50523	129	4,70€	50808	85	77,00€	51120	210	41,00€	51349	200	37,30€
50524	129	4,70€	50815	261	88,00€	51121	211	27,30€	51352	179	9,80€
50525	300	1,00€	50816	261	88,00€	51123	196	91,00€	51353	179	11,50€
50526	300	4,80€	50818	261	198,00€	51124	197	88,00€	51354	180	13,20€
50551	130	350,00€	50819	262	28,00€	51125	196	88,00€	51355	62,310	19,00€
50560	37	38,60€	50820	262	34,50€	51126	198	18,00€	51356	258	48,00€
50561	38	19,20€	50821	262	47,00€	51127	203	56,00€	51358	312	7,50€
50562	39	23,50€	50822	262	59,00€	51127R	203	14,00€	51359	312	9,00€
50564	38	30,00€	50823	262	94,00€	51131	161	61,00€	51360	162	8,05€
50567	58	9,60€	50824	262	88,00€	51140	201,237	64,00€	51361	162	9,80€
50577	164	12,60€	50825	262	154,00€	51206	132	228,00€	51362	312	3,00€
50585	306	14,70€	50827	211,267	387,00€	51207	132	289,00€	51363	272	114,00€
50600	308	0,60€	50830	264	560,00€	51210	133	650,00€	51364	201	26,00€
50601	308	0,29€	50831	267	460,00€	51211	133	560,00€	51365	272	118,00€
50622	36	64,00€	50835	265	290,00€	51212	133	488,00€	51368	194	19,00€
50623	24	60,00€	50836	268	148,00€	51213	133	690,00€	51369	194	28,00€
50630	269	590,00€	50838	268	299,00€	51214	135	148,00€	51383	144	11,10€
50631	267	68,00€	50839	270	180,00€	51215	135	119,00€	51384	25	34,00€
50632	279	298,00€	50840	268	138,00€	51216	136	650,00€	51385	142	4,55€
50644	301	11,60€	50843	85	79,00€	51218	135	288,00€	51386	142	5,95€
50651	332	16,50€	50844	85	65,00€	51219	136	222,00€	51387	142	3,25€
50652	332	16,50€	50852	257	24,50€	51220	135	240,00€	51388	136	22,00€
50654	300,317	4,00€	50901	162	16,00€	51221	134	199,00€	51389	136	22,00€
50656	172	290,00€	50902	42	13,00€	51222	134	128,00€	51390	136	22,00€
50717	301	21,90€	50903	162	30,80€	51225	135	198,00€	51391	136	22,00€
50724	204	28,00€	50910	128	45,00€	51226	136	233,00€	51392	136	34,00€
50731	254	68,00€	50911	269	788,00€	51227	136	193,00€	51393	136	34,00€
50751	143,257	43,00€	50913	172	195,00€	51235	273	49,00€	51398N	316	1,74€
50754	36	98,00€	50915	129	4,20€	51238	272	138,00€	51400	182	17,00€
50760	308	0,10€	50916	170	0,88€	51239	272	159,00€	51401	182	22,00€
50761	308	0,19€	50917	252	271,00€	51245	137	99,00€	51402	182	20,50€
50762	308	0,29€	50918	252	341,00€	51246	303,318	6,40€	51403	182	17,50€
50763	308	0,38€	50923	167,270	454,00€	51253	252	41,00€	51405	52	21,10€
50764	308	0,49€	50924	249	342,00€	51258	119	0,15€	51406	52	29,20€

REF.	Pg.	RRP	REF.	Pg.	RRP	REF.	Pg.	RRP	REF.	Pg.	RRP
51409	25	36,00€	51656	81	3,65€	51816	273	49,00€	51967	125	16,00€
51410	25	36,00€	51657	81	5,85€	51817	300,317	4,50€	51968	125	16,00€
51412	303	2,10€	51658	81	4,50€	51818	19	95,00€	51969	124	14,00€
51414	194	14,00€	51659	36	59,00€	51819	16	48,00€	51972	57	12,00€
51416	311	12,00€	51661	53,311	12,00€	51824	170	36,80€	51973	305	45,00€
51419	81	2,79€	51674	46	7,75€	51830	204	94,00€	51975	81	2,27€
51422	81	2,97€	51680	298	2,40€	51831	276	24,00€	51976	81	1,63€
51439	136	26,00€	51681	298	4,50€	51832	162	18,00€	51978	169	84,00€
51440	136	28,00€	51691	298	2,40€	51837	280	195,00€	51980	143	15,00€
51441	136	26,00€	51692	298	3,25€	51838	280	667,00€	51981	143	21,50€
51442	136	28,00€	51693	298	3,55€	51839	176,275	24,00€	51982	293	120,00€
51443	142	5,50€	51694	298	3,55€	51842	273	6,90€	51983	293	180,00€
51444	142	5,05€	51696	298	3,55€	51843	330	0,19€	51984	293	190,00€
51445	142	5,05€	51697	300	0,80€	51853	47	18,00€	51985	170	84,00€
51447	54,80	16,00€	51703	314	10,50€	51855	23	378,00€	51986	215	11,90€
51448	54,80	52,00€	51705	314	8,45€	51858	305	15,00€	51989	216	49,00€
51452	268	69,00€	51706	313	22,80€	51859	276	3,80€	51991	195	48,00€
51456	81	550,00€	51707	313	9,05€	51861	136,314	199,00€	51995	60,61	24,50€
51479	55	31,80€	51708	313	14,20€	51863	305	54,00€	51998	190	38,00€
51488	245	16,00€	51709	313	14,70€	51864	40,78	64,00€	52009	32,289	36,00€
51489	245	12,00€	51710	313	17,80€	51886	128	44,00€	52010	198	80,00€
51490	196	36,00€	51711	313	21,20€	51889	115	49,00€	52012	205	68,00€
51491	186	154,00€	51712	313	8,65€	51890	41	92,00€	52016	187	2,10€
51493	185	68,00€	51713	313	13,10€	51893	189	690,00€	52017	187	2,40€
51494	183	107,00€	51714	313	15,80€	51895	261	99,00€	52018	187	2,60€
51495	191	59,00€	51715	313	20,30€	51896	187	82,00€	52019	187	3,20€
51496	192	8,00€	51716	313	23,60€	51897	187	122,00€	52021	187	3,40€
51500	194	29,00€	51717	313	11,20€	51898	187	139,00€	52022	187	4,50€
51501	195	38,00€	51718	313	14,80€	51899	187	137,00€	52023	187	6,60€
51504	46	8,50€	51719	313	22,00€	51901	265	999,00€	52024	187	10,60€
51525	55	9,80€	51720	313	23,50€	51902	195	84,00€	52025	187	13,00€
51526	55	9,80€	51721	313	25,00€	51905	262	34,50€	52026	162	31,80€
51528	40	49,00€	51722	313	13,10€	51906	262	39,00€	52027	324	14,00€
51529	38	59,00€	51723	313	18,70€	51907	262	48,00€	52028	326	15,20€
51546	330	0,19€	51724	313	24,40€	51908	309	44,00€	52029	326	14,00€
51554	330	0,28€	51725	313	28,30€	51909	44	2,46€	52030	329	98,00€
51573	119,302	2,50€	51726	313	31,40€	51918	46	12,50€	52031	328	44,00€
51574	84	52,00€	51727	313	49,00€	51919	205	89,00€	52032	329	28,00€
51575	84	317,00€	51737	82	699,00€	51920	215,332	18,00€	52033	333	43,00€
51576	81	125,00€	51738	82	850,00€	51923	179	12,50€	52043	327	16,50€
51600	84	109,00€	51741	311	0,50€	51925	300	1,00€	52044	325	19,00€
51604	308	0,98€	51742	311	0,50€	51927	246	25,00€	52047	129	3,30€
51612	129	5,95€	51743	311	0,55€	51928	256	14,00€	52048	129	3,95€
51613	129	2,90€	51745	316	0,70€	51929	129	22,00€	52049	48	14,00€
51614	129	3,60€	51746	30	12,00€	51930	24	39,00€	52050	61	98,00€
51615	129	5,95€	51750	269	299,00€	51934	179	11,50€	52052	58	53,00€
51616	23	378,00€	51751	270	99,00€	51935	302	135,00€	52053	335	45,00€
51622	171	25,30€	51785	316	0,75€	51936	302	135,00€	52054	335	17,00€
51632N	316	1,74€	51795	63	9,00€	51937	302	135,00€	52055	268	129,00€
51633	316	1,74€	51796	63	14,00€	51951	47	15,60€	52056	205	66,00€
51634	316	1,74€	51797	63	18,00€	51958	204	422,00€	52057	170	6,80€
51636N	316	1,54€	51798	63	39,60€	51960	124	34,00€	52058	170	4,50€
51638N	316	1,54€	51799	330	0,20€	51961	124	34,00€	52059	30	29,00€
51640N	316	1,54€	51801	53	62,00€	51962	123	25,00€	52060	30	32,00€
51642N	316	1,54€	51804	328	58,00€	51963	123	29,00€	52065	170	45,00€
51653	81	5,10€	51805	54,80	17,00€	51964	123	28,00€	52066	213	12,00€
51654	81	4,80€	51812	59	46,00€	51965	123	29,50€	52069	272	29,50€
51655	81	4,10€	51814	300	8,00€	51966	124	18,00€	52070	272	40,00€

REF.	Pg.	RRP	REF.	Pg.	RRP	REF.	Pg.	RRP	REF.	Pg.	RRP
52071	272	47,00€	52270	199	109,00€	52368	130	1,14€	52478	165	49,00€
52076	190	111,00€	52271	245	18,00€	52369	130	1,19€	52479	165	24,70€
52077	163	29,50€	52272	59	24,60€	52370	130	1,17€	52480	165	44,00€
52148	85	82,00€	52273	185	44,00€	52373	81	252,00€	52481	165	52,00€
52149	293	230,00€	52275	176	38,00€	52375	123	38,00€	52482	165	44,00€
52152	57	13,50€	52293	193	98,00€	52378	142,214	10,00€	52483	165	41,00€
52153	190	46,00€	52295	166	6,50€	52381	144	20,50€	52484	165	66,00€
52156	140	140,00€	52296	198	119,00€	52382	274,288	19,50€	52485	165	51,00€
52157	141	48,00€	52297	198	172,00€	52384	117	29,00€	52486	165	62,00€
52158	328	38,50€	52298	198	177,00€	52385	164	251,00€	52487	165	63,00€
52159	141	64,00€	52302	125	25,40€	52386	164	23,60€	52488	188	28,00€
52160	141	48,00€	52303	126	26,40€	52387	164	24,50€	52489	189	58,00€
52162	71,275,290	38,00€	52304	262	84,00€	52390	165	35,20€	52490	144	6,65€
52163	330	95,00€	52305	190	106,00€	52391	258	5,00€	52491	144	10,50€
52165	140	118,00€	52308	86	440,00€	52393	74	1.180,00€	52493	300,320	4,50€
52167	140	48,00€	52309	86	941,00€	52412	59	5,00€	52494	200	227,00€
52169	43	25,00€	52310	316	3,65€	52414	126	19,00€	52495	206	14,50€
52170	43	16,00€	52311	179	19,00€	52415	126	19,00€	52497	213	26,80€
52171	141	39,00€	52312	179	9,00€	52416	180	14,00€	52498	256	58,00€
52172	74	780,00€	52313	179	8,00€	52417	180	28,00€	52500	42	19,00€
52180	46	19,00€	52314	179	26,60€	52418	23	164,00€	52502	165	31,40€
52181	46	22,50€	52315	176	16,00€	52419	81	80,00€	52503	165	32,50€
52182	46	24,00€	52316	192	18,90€	52420	81	108,00€	52504	165	27,60€
52183	46	26,20€	52317	192	19,90€	52421	81	172,00€	52505	164	20,80€
52184	46	43,00€	52318	194	73,00€	52422	160	24,70€	52506	164	16,00€
52185	46	55,00€	52319	215	8,80€	52424	63	64,00€	52507	165	30,10€
52186	46	72,00€	52320	30	22,00€	52425	46	33,30€	52508	61	38,40€
52187	305	21,80€	52321	167	8,80€	52426	46	52,00€	52509	61	36,20€
52188	47	15,50€	52327	167	12,00€	52427	46	64,00€	52511	165	42,00€
52190	194	8,00€	52328	176	99,00€	52428	252	43,00€	52512	164	50,00€
52191	176	198,00€	52329	252	36,40€	52430	318	10,90€	52514	270	84,00€
52195	279	170,00€	52330	174	99,00€	52432	199	35,00€	52515	62,216	9,10€
52197	52	36,30€	52331	140	201,00€	52433	204	4,80€	52516	214	28,00€
52198	29	37,70€	52337	150	65,00€	52434	176	125,00€	52517	214	6,00€
52200	294	88,00€	52338	151	41,00€	52436	276	680,00€	52518	179	115,00€
52201	294	66,00€	52339	153	61,00€	52439	274	227,00€	52519	32,289	25,50€
52202	294	88,00€	52340	153	58,00€	52450	275	105,00€	52521	32,289	125,00€
52207	51	24,20€	52341	150	58,00€	52451	39	42,00€	52524	54	51,00€
52227	211	247,00€	52342	151	63,00€	52452	249	8,00€	52525	54	13,80€
52230	172	398,00€	52343	152	52,00€	52453	249	21,00€	52526	54	28,40€
52231	275	49,00€	52344	153	197,00€	52454	202	12,90€	52527	141	82,00€
52233	273	328,00€	52345	150	109,00€	52455	176	16,00€	52528	137	49,00€
52235	64	11,00€	52346	150	103,00€	52456	123	36,00€	52530	306	14,00€
52236	64	13,30€	52347	154	158,00€	52458	128	58,00€	52533	166	10,00€
52237	64	18,10€	52348	154	179,00€	52460	47	16,60€	52534	306	15,00€
52238	64	24,90€	52349	64	22,10€	52461	47	25,70€	52535	306	16,50€
52241	265	1.690,00€	52350	64	22,60€	52462	49	25,30€	52536	114	57,00€
52242	258	12,00€	52351	64	25,40€	52463	49	26,10€	52538	28	62,00€
52243	258	8,50€	52352	64	32,40€	52464	49	42,00€	52539	28	59,00€
52244	169	84,00€	52353	64	33,40€	52466	214	11,00€	52540	171	221,00€
52251	305	21,80€	52354	64	34,40€	52467	214	10,30€	52541	196	45,00€
52254	120	64,00€	52355	64	36,60€	52468	55	5,90€	52542	85	109,00€
52259	300	3,75€	52357	64	54,00€	52472	55	4,90€	52543	143	182,00€
52262	166	7,50€	52358	64	63,00€	52473	55	9,90€	52544	154	93,00€
52263	166	13,50€	52362	130	1,23€	52474	165	68,00€	52545	154	177,00€
52264	166	18,60€	52363	130	1,23€	52475	165	62,00€	52546	153	39,60€
52265	166	30,50€	52364	130	2,86€	52476	165	50,00€	52547	150	96,00€
52269	180	7,00€	52365	130	2,46€	52477	165	70,00€	52550	27	92,00€

REF.	Pg.	RRP	REF.	Pg.	RRP	REF.	Pg.	RRP	REF.	Pg.	RRP
52551	201	151,00€	52642	196	32,00€	52729	198	128,00€	52813	185	79,00€
52552	313	128,00€	52643	278	596,00€	52730	198	288,00€	52814	134	528,00€
52555	119	2,38€	52644	314	8,80€	52731	198	38,00€	52815	190	110,00€
52558	119	2,38€	52645	313	0,55€	52732	198	58,00€	52816	190	28,10€
52565	46	11,50€	52646	313	0,50€	52733	198	98,00€	52817	190	23,50€
52566	125	28,00€	52648	143	9,00€	52734	210	51,00€	52818	310	148,00€
52567	125	29,00€	52649	311	5,00€	52735	148	4,85€	52819	246	22,00€
52568	126	28,00€	52650	311	5,00€	52736	148	5,35€	52821	183	28,80€
52569	126	28,00€	52652	310	2,80€	52737	148	5,50€	52822	186	32,00€
52570	316	2,60€	52653	310	3,00€	52738	316	5,00€	52823	191	124,00€
52571	316	2,60€	52655	312	39,70€	52739	316	5,00€	52827	124	46,00€
52572	316	2,60€	52656	312	39,50€	52740	120	690,00€	52828	124	43,00€
52573	316	2,60€	52657	312	37,50€	52742	305	64,00€	52829	314	19,00€
52574	137	69,00€	52658	312	39,70€	52749	168	79,00€	52830	47	24,00€
52575	50,137	119,00€	52659	312	39,70€	52753	27	107,00€	52831	47	18,00€
52583	204	8,50€	52660	313	126,00€	52754	188	54,00€	52832	193	75,00€
52587	52	39,90€	52661	313	290,00€	52757	216	16,00€	52833	192	39,30€
52588	52	45,00€	52662	310	36,50€	52758	139	88,00€	52834	199	195,00€
52589	166	13,00€	52663	310	30,00€	52760	62,216	4,10€	52835	199	272,00€
52591	211	12,00€	52664	312	168,00€	52761	57	8,00€	52836	120	1.100,00€
52592	211	22,00€	52665	308	0,37€	52762	57	9,00€	52838	128	56,00€
52593	211	34,00€	52666	308	0,36€	52765	166	21,70€	52839	64,128	64,00€
52595	49	64,00€	52667	308	0,76€	52768	299	13,80€	52842	311	11,00€
52596	49	114,00€	52668	308	1,49€	52769	299	14,50€	52843	124	31,60€
52597	49	146,00€	52669	308	2,22€	52770	299	23,00€	52845	270	170,00€
52598	106,281	1.080,00€	52670	308	2,95€	52771	299	23,40€	52846	59	37,80€
52599	189	230,00€	52671	308	3,70€	52772	299	13,90€	52847	59	41,00€
52600	287	884,00€	52672	308	4,45€	52773	299	14,60€	52848	128	88,00€
52601	252	397,00€	52673	310	18,00€	52774	299	14,80€	52849	202	8,50€
52603	26	74,00€	52675	139	84,00€	52775	299	15,20€	52850	210	7,80€
52604	26	78,00€	52676	139	98,00€	52776	299	13,80€	52851	163,343	9,65€
52605	26	76,00€	52677	180	17,00€	52777	299	15,50€	52852	62	6,80€
52606	26	88,00€	52678	180	18,00€	52778	299	14,60€	52857	351	7,50€
52607	181	49,00€	52685	188	88,00€	52779	299	17,10€	52858	184	298,00€
52608	181	44,00€	52687	208	168,00€	52780	299	13,90€	52862	130	1,15€
52609	50	29,00€	52690	193	54,00€	52781	299	14,60€	52864	130	1,20€
52615	179	112,00€	52691	192	54,00€	52782	299	14,80€	52866	130	0,25€
52616	246	44,00€	52692	268	129,00€	52783	299	15,20€	52869	86	52,00€
52617	182	7,00€	52693	210	24,50€	52786	56	14,60€	52870	86	100,00€
52618	301	29,00€	52694	150	49,00€	52787	144	9,00€	52871	86	248,00€
52619	61	23,10€	52696	210	12,00€	52788	162	39,00€	52873	204	11,00€
52620	213	8,80€	52697	210	16,00€	52789	256	15,20€	52874	195	82,00€
52621	215	11,00€	52699	196	22,00€	52791	60,61	18,00€	52875	195	79,00€
52624	194	28,00€	52700	192	20,50€	52794	204	28,00€	52876	160	182,00€
52625	62,176	9,00€	52703	327	22,00€	52795	300	5,80€	52877	56	15,80€
52626	196	46,00€	52711	327	27,50€	52796	205	98,00€	52878	56	11,20€
52627	196	120,00€	52713	19	89,00€	52797	255	198,00€	52879	56	10,10€
52628	256	26,50€	52714	29	15,70€	52798	144	18,00€	52880	53,311	42,00€
52629	184	99,00€	52715	29	10,00€	52801	186,256	26,00€	52881	53,311	17,00€
52633	310	1,00€	52716	29	15,90€	52802	191	54,00€	52882	160	14,00€
52634	81	5,25€	52717	29	11,00€	52804	248	343,00€	52883	116	38,00€
52635	81	4,80€	52718	141	48,00€	52805	248	426,00€	52884	273	73,00€
52636	174	114,00€	52719	330	0,19€	52806	248	742,00€	52885	62	18,00€
52637	202	48,00€	52722	18	87,00€	52807	248	1.714,00€	52886	336	18,00€
52638	62	9,95€	52724	138	381,00€	52809	179	8,50€	52887	336	22,00€
52639	195	123,00€	52725	138	349,00€	52810	153	9,00€	52888	341	24,00€
52640	195	52,00€	52727	198	34,60€	52811	153	9,90€	52889	338	19,00€
52641	195	55,00€	52728	198	68,00€	52812	61	65,00€	52890	339	22,00€

REF.	Pg.	RRP	REF.	Pg.	RRP	REF.	Pg.	RRP	REF.	Pg.	RRP
52891	339	28,00€	52957	57	23,80€	53058	200	193,00€	53141	137	68,00€
52892	338	22,00€	52958	57	28,20€	53059	201	52,00€	53144	257	18,00€
52893	339	26,00€	52959	57	42,00€	53060	151	34,90€	53145	278	39,20€
52894	338	22,00€	52960	57	46,00€	53062	197	99,00€	53146	198	30,50€
52895	340	22,00€	52962	190	42,00€	53063	144	36,70€	53147	142	41,00€
52896	336	26,00€	52963	254	49,00€	53064	144	37,40€	53150	309	24,00€
52897	340	38,00€	52964	58	9,45€	53065	144	36,90€	53151	127	14,00€
52898	340	36,00€	52965	58	9,20€	53066	144	61,00€	53154	31,288	462,00€
52899	337	34,00€	52966	58	9,45€	53067	144	61,00€	53156	29	26,20€
52900	337	34,00€	52967	58	9,40€	53068	144	63,00€	53159	20	289,00€
52901	337	34,00€	52969	151	20,70€	53069	183	98,00€	53162	278	60,00€
52902	287	970,00€	52973	38	59,00€	53070	64	16,20€	53164	32,289	16,50€
52903	287	1.100,00€	52977	162	137,00€	53071	64	26,10€	53165	32,289	19,60€
52904	204	61,00€	52980	279	480,00€	53072	64	31,60€	53166	283	10,50€
52905	56	28,00€	52982	164	53,00€	53073	64	50,00€	53167	283	12,50€
52906	175	38,00€	52985	267	598,00€	53074	15	78,00€	53168	283	19,00€
52908	29	17,00€	52987	116	20,00€	53077	152	62,00€	53177	299	11,90€
52909	29	12,50€	52991	258	10,50€	53078	249	18,00€	53178	299	12,20€
52910	124	39,00€	52992	258	18,00€	53079	168	89,00€	53179	299	12,20€
52912	40,78	91,00€	52998	166	48,00€	53080	168	99,00€	53180	299	12,20€
52913	203	292,00€	52999	266	168,00€	53081	203	115,00€	53181	299	11,90€
52914	156	223,00€	53001	206	242,00€	53082	203	148,00€	53182	299	12,20€
52915	156	199,00€	53007	130	0,42€	53083	48	64,00€	53183	299	12,70€
52916	156	218,00€	53008	179	15,50€	53084	30	24,00€	53184	299	12,20€
52917	156	122,00€	53009	184	42,00€	53085	119	30,00€	53185	299	13,20€
52918	156	146,00€	53010	42	18,00€	53086	216	9,00€	53186	299	13,20€
52919	156	181,00€	53017	34	57,00€	53087	299	11,20€	53187	258	39,00€
52920	156	155,00€	53018	36	119,00€	53088	299	11,50€	53188	258	7,00€
52921	156	117,00€	53025	44	3,50€	53089	299	11,50€	53189	284	128,00€
52922	156	180,00€	53026	44	5,80€	53090	299	11,50€	53190	284	98,00€
52923	156	59,00€	53027	44	9,00€	53091	299	10,20€	53191	171	14,80€
52924	157	52,00€	53028	275	5,80€	53092	299	10,30€	53192	171	52,00€
52925	157	176,00€	53029	275	6,80€	53093	299	10,30€	53196	213	33,00€
52926	157	201,00€	53030	275	12,00€	53094	299	10,20€	53197	152	46,00€
52927	157	59,00€	53031	86	59,00€	53095	48	20,50€	53198	258	9,50€
52928	157	172,00€	53032	86	126,00€	53096	216	28,80€	53200	263	69,00€
52929	157	185,00€	53033	305	21,50€	53102	17	36,00€	53202	145	15,70€
52930	157	117,00€	53037	313	0,50€	53104	25	34,00€	53203	130	0,46€
52931	157	45,00€	53038	313	0,50€	53105	25	37,00€	53204	145	81,00€
52932	157	45,00€	53039	313	0,50€	53106	19	99,00€	53205	144	19,00€
52933	157	194,00€	53040	313	0,50€	53108	18	92,00€	53206	180	38,20€
52934	158	102,00€	53041	187	37,60€	53110	163,343	27,30€	53207	191	118,00€
52935	158	94,00€	53042	204	9,90€	53111	277	19,00€	53208	191	126,00€
52936	158	199,00€	53043	152	53,00€	53112	260	298,00€	53209	273	8,50€
52937	158	265,00€	53044	153	121,00€	53118	211	231,00€	53210	64	48,00€
52938	158	199,00€	53045	126	35,00€	53119	160	52,00€	53211	85	75,00€
52939	158	28,00€	53046	126	39,00€	53120	48	6,00€	53212	14	149,00€
52940	158	235,00€	53047	126	330,00€	53121	48	7,35€	53214	248	285,00€
52941	158	70,00€	53048	126	89,00€	53122	48	9,50€	53215	257	19,00€
52942	158	105,00€	53049	125	89,00€	53124	167	287,00€	53216	115	49,00€
52943	158	75,00€	53051	126	158,00€	53125	167	477,00€	53217	116	47,00€
52944	158	110,00€	53052	126	158,00€	53126	169	243,00€	53218	263	26,00€
52945	158	281,00€	53053	194	12,00€	53127	30	12,00€	53219	16	49,00€
52952	274,288	74,00€	53054	216	6,00€	53129	200	84,00€	53220	279	260,00€
52953	142	38,00€	53055	215	33,00€	53134	169	144,00€	53221	301	4,75€
52955	57	19,80€	53056	200	127,00€	53137	137	38,00€	53222	84	57,00€
52956	57	19,60€	53057	206	149,00€	53140	138	98,00€	53224	160	142,00€

REF.	Pg.	RRP	REF.	Pg.	RRP	REF.	Pg.	RRP	REF.	Pg.	RRP
53225	55	3,50€	53297	233	45,00€	53366	326	14,00€	53443	300	7,55€
53226	171	14,90€	53298	234	91,00€	53367	334	9,50€	53444	22	195,00€
53227	119	28,00€	53299	234	291,00€	53368	334	9,00€	53445	189	17,10€
53229	329	38,70€	53300	234	41,00€	53369	326	14,00€	53449	143	14,00€
53230	163	19,70€	53301	235	44,00€	53370	324	26,00€	53450	143	28,30€
53232	163	39,00€	53302	236	44,00€	53371	325	29,00€	53452	234	26,50€
53235	182	10,40€	53303	236	89,00€	53372	324	26,00€	53453	254	7,00€
53236	182	11,50€	53304	236	279,00€	53373	331	14,50€	53456	207	98,00€
53237	182	12,90€	53305	236	136,00€	53374	332	10,00€	53459	207	66,00€
53238	182	18,40€	53306	240	53,00€	53376	332	10,50€	53463	202	98,00€
53240	212	58,00€	53307	237	38,50€	53377	328	20,00€	53464	184,330	153,00€
53241	306	9,00€	53308	241	55,00€	53378	334	13,00€	53468	54	8,50€
53246	269	1.144,00€	53309	240	285,00€	53380	335	11,50€	53469	73	613,00€
53249	212	192,00€	53310	239	498,00€	53381	331	14,50€	53470	154	176,00€
53250	197	85,00€	53311	238	97,00€	53382	331	11,00€	53472	182	12,00€
53251	210	88,00€	53312	239	127,00€	53383	331	11,50€	53473	182	36,00€
53253	107	98,00€	53313	238	139,00€	53384	196	165,00€	53474	212	94,00€
53256	309	34,00€	53314	238	98,00€	53385	56,343	19,30€	53477	213	36,10€
53258	107	67,00€	53315	244	285,00€	53388	198	90,00€	53478	54	4,55€
53259	218	97,00€	53316	237	34,00€	53389	58	31,50€	53479	54	6,40€
53260	218	168,00€	53317	246	34,00€	53390	60	34,50€	53480	54	19,90€
53261	218	214,00€	53318	245	24,00€	53391	199	86,00€	53481	54	27,40€
53262	218	251,00€	53319	240	18,00€	53393	199	118,00€	53484	276	615,00€
53263	219	57,00€	53320	245	12,00€	53394	211	598,00€	53485	209	140,00€
53264	220	143,00€	53321	246	10,50€	53395	213	16,00€	53486	160	29,30€
53265	219	195,00€	53324	233	12,50€	53396	60	18,30€	53487	61	16,70€
53266	220	224,00€	53325	246	7,50€	53399	45	3,50€	53488	194	61,00€
53267	220	277,00€	53326	226	16,00€	53400	45	5,70€	53489	188	68,00€
53268	221	92,00€	53327	226	11,00€	53401	45	7,40€	53490	189	275,00€
53269	220	50,00€	53328	191	76,00€	53402	45	9,60€	53492	142,353	380,00€
53270	222	70,00€	53330	186	38,00€	53403	45	6,50€	53499	207	29,00€
53271	222	227,00€	53331	50	31,80€	53404	45	6,50€	53500	207	29,00€
53272	222	195,00€	53332	50	34,50€	53405	45	5,30€	53501	184	24,00€
53273	223	75,00€	53339	47	9,50€	53406	45	8,55€	53502	192	38,70€
53274	225	30,50€	53340	329	86,00€	53407	45	12,70€	53503	275	12,00€
53275	228	35,50€	53343	137	285,00€	53408	45	19,30€	53504	351	38,00€
53276	225	160,00€	53344	137	295,00€	53409	45	9,00€	53505	120	77,00€
53277	223	45,00€	53346	52	18,00€	53410	206	92,00€	53506	120	36,00€
53278	224	143,00€	53347	209	100,00€	53411	56	5,00€	53507	302	24,00€
53279	226	97,00€	53348	324	14,00€	53412	56	4,00€	53508	302	14,00€
53280	226	112,00€	53349	324	14,00€	53414	162	49,00€	53509	73	482,00€
53281	225	55,00€	53350	324	14,00€	53415	162	188,00€	53510	351	24,00€
53282	225	48,00€	53351	325	12,50€	53416	143	14,10€	53511	351	23,00€
53283	227	92,00€	53352	325	12,00€	53417	143	26,30€	53512	351	41,00€
53284	224	306,00€	53353	331	18,00€	53418	143	16,90€	53513	351	9,00€
53285	227	56,00€	53354	326	14,00€	53419	311	9,70€	53514	73	990,00€
53286	227	87,00€	53355	334	11,50€	53420	40	72,00€	53517	56	9,50€
53287	227	245,00€	53356	334	11,50€	53421	260	298,00€	53518	249	3,50€
53288	228	72,00€	53357	272,334	7,00€	53422	260	368,00€	53519	114	42,00€
53289	229	45,00€	53358	334	11,50€	53423	269	199,00€	53520	132	228,00€
53290	229	51,00€	53359	333	16,00€	53426	188	39,80€	53522	184	24,00€
53291	229	68,00€	53360	327	18,00€	53427	119	5,00€	53523	229	91,00€
53292	230	116,00€	53361	327	24,00€	53428	125	18,00€	53524	63	51,00€
53293	231	134,00€	53362	326	14,00€	53429	125	18,00€	53525	213	12,00€
53294	233	119,00€	53363	325	34,00€	53430	158	286,00€	53526	283,292	168,00€
53295	232	77,00€	53364	325	16,00€	53434	333	18,00€	53530	116,208	46,00€
53296	233	60,00€	53365	327	14,00€	53441	179	9,80€	53531	150	109,00€

REF.	Pg.	RRP	REF.	Pg.	RRP	REF.	Pg.	RRP	REF.	Pg.	RRP
53532	146,292	119,00€	53603	57	45,00€	53662	209	89,00€	53727	23	198,00€
53533	350	1,50€	53604	57	118,00€	53663	212	8,00€	53728	23	198,00€
53536	129	34,00€	53605	312	141,00€	53664	194	38,00€	53729	213	19,10€
53537	181	14,50€	53606	145	55,00€	53665	215	19,00€	53733	132	238,00€
53538	181	14,50€	53607	145	292,00€	53666	215	28,00€	53734	114	23,70€
53539	208	78,00€	53608	132	98,00€	53667	30	32,00€	53735	181	44,00€
53540	298	23,00€	53609	250	190,00€	53668	30	34,00€	53736	168	98,00€
53541	138	168,00€	53610	250	294,00€	53669	206	45,00€	53737	41	12,50€
53542	138	980,00€	53611	144	27,50€	53670	180	29,50€	53738	41	10,90€
53543	284	13,80€	53612	249	96,00€	53671	51,79	41,00€	53739	41	10,50€
53545	163	35,70€	53613	44	19,50€	53672	83	440,00€	53740	41	9,10€
53547	58	14,70€	53614	44	21,50€	53673	161	80,00€	53741	181	14,00€
53548	58	15,60€	53615	44	34,60€	53674	82	447,00€	53743	28,154	39,70€
53549	58	14,30€	53616	44	10,40€	53675	164	50,00€	53744	151	63,00€
53550	58	14,70€	53617	44	9,25€	53676	164	44,00€	53745	307	6,40€
53551	317	18,95€	53618	44	13,90€	53677	164	55,00€	53746	307	6,40€
53552	317	18,95€	53620	80	88,00€	53678	164	52,00€	53747	307	6,40€
53553	317	18,95€	53621	298	2,50€	53681	134	743,00€	53748	307	6,60€
53556	73	990,00€	53622	298	2,50€	53682	268	98,00€	53749	307	6,70€
53557	73	990,00€	53623	298	2,50€	53683	174	116,00€	53750	307	6,70€
53561	302	28,00€	53624	298	2,50€	53684	266	1.880,00€	53751	307	6,80€
53565	84	258,00€	53625	141	68,00€	53685	168	310,00€	53752	307	6,95€
53566	254	32,00€	53626	140,161	18,00€	53686	69	890,00€	53753	307	7,10€
53567	136,166	43,00€	53627	254	22,50€	53687	272	298,00€	53754	307	7,40€
53568	118	12,00€	53629	147	14,30€	53688	272	495,00€	53755	307	7,50€
53569	118	18,00€	53630	147	18,80€	53689	133	238,00€	53756	307	7,90€
53570	121	154,00€	53631	147	33,50€	53690	122	34,00€	53757	307	7,90€
53572	138,210	348,00€	53632	147	46,00€	53691	122	36,00€	53758	307	8,20€
53573	141	36,00€	53633	147	46,00€	53693	314	521,00€	53759	307	8,50€
53574	28,42	47,00€	53634	147	63,00€	53694	42	18,40€	53760	307	9,60€
53575	43	16,00€	53635	202	85,00€	53695	314	504,00€	53761	69	680,00€
53576	139	189,00€	53636	302	22,00€	53696	215	22,00€	53762	69	680,00€
53577	73	990,00€	53637	210	85,00€	53697	250	398,00€	53763	68	890,00€
53578	73	990,00€	53638	202	243,00€	53698	314	717,00€	53764	68	680,00€
53579	73	990,00€	53639	63	28,60€	53701	197	188,00€	53765	68	890,00€
53580	73	990,00€	53640	63	34,40€	53702	107	28,50€	53766	68	680,00€
53581	146,292	115,00€	53641	63	41,00€	53703	107	41,00€	53767	69	890,00€
53582	146,292	179,00€	53642	63	54,00€	53704	107	42,00€	53768	69	680,00€
53583	146,292	170,00€	53643	63	92,00€	53705	170	80,00€	53769	72,230	178,00€
53584	283,292	119,00€	53644	251	1.238,00€	53706	224	98,00€	53770	72,242	198,00€
53585	283,292	168,00€	53645	251	268,00€	53707	121	153,00€	53771	72,243	158,00€
53586	283,292	158,00€	53646	139,140,161	62,00€	53708	66,68 69,74,76	325,00€	53772	72,243	229,00€
53587	151	44,00€	53647	14	96,00€	53710	344	16,00€	53773	72,241	298,00€
53588	132	164,00€	53648	224	107,00€	53711	344	16,00€	53774	72,242	190,00€
53589	62	12,00€	53649	228	89,00€	53712	344	16,00€	53775	72,244,245	1.109,00€
53590	266	1.190,00€	53650	186	47,00€	53713	343	16,00€	53776	116	19,10€
53591	56	5,50€	53651	235	91,00€	53714	343	16,00€	53777	270	4.352,00€
53592	257	25,00€	53652	191	53,00€	53715	343	19,00€	53778	300	4,50€
53593	145	41,00€	53653	231	207,00€	53716	342	19,00€	53779	263	36,00€
53594	147	54,00€	53654	63	81,00€	53717	342	19,00€	53780	117	14,50€
53595	147	61,00€	53655	213	12,00€	53718	342	19,00€	53781	319	18,00€
53596	318	3,65€	53656	278	198,00€	53719	341	19,00€	53782	107	14,00€
53597	318	3,70€	53657	278	248,00€	53720	341	19,00€	53784	135	148,00€
53598	318	3,95€	53658	278	99,00€	53723	309	68,00€	53785	318	4,80€
53599	207,331	30,30€	53659	278	121,00€	53724	276	46,00€	53786	322	98,00€
53600	284	13,80€	53660	279	146,00€	53725	260	248,00€	53787	319	0,98€
53602	57	30,50€	53661	69	890,00€	53726	133	128,00€	53787O	319	0,98€
									53791	320	4,80€

REF.	Pg.	RRP	REF.	Pg.	RRP	REF.	Pg.	RRP	REF.	Pg.	RRP
53794	320	28,00€	53877	352	430,50€	53951	72,245	1.794,00€	54023	51	13,50€
53796	322	76,00€	53878	352	574,00€	53952	72,245	1.794,00€	54024	51	17,90€
53797	319	0,10€	53879	352	838,50€	53953	16	29,00€	54028	50	28,00€
53798	320	1,95€	53880	270	598,00€	53954	41	8,50€	54029	50	28,00€
53802	322	120,00€	53881	146,292	79,00€	53955	41	10,00€	54030	50	18,80€
53803	320	0,90€	53882	146,292	79,00€	53956	348	353,00€	54031	50	19,30€
53804	320	0,80€	53883	53	18,40€	53957	319	0,26€	54032	35	84,00€
53805	322	220,00€	53884	53	30,20€	53958	214	6,50€	54033	136	49,00€
53806	322	250,00€	53885	53	35,70€	53959	319	0,98€	54034	7	178,00€
53808	321	16,50€	53886	53	20,30€	53960	319	0,98€	54035	10	149,00€
53809	321	8,00€	53887	53	30,30€	53961	319	0,98€	54036	11	99,00€
53811	321	8,90€	53888	53	37,90€	53964	305	9,65€	54037	12	88,00€
53812	321	23,50€	53893	319	5,00€	53965	305	25,80€	54038	13	88,00€
53820	280	388,00€	53895	262	107,00€	53967	60	10,20€	54039	122	154,00€
53822	320	2,50€	53896	262	127,00€	53968	261	49,00€	54040	274	240,00€
53824	320	2,85€	53897	262	140,00€	53969	268	96,00€	54041	35	198,00€
53826	319	16,00€	53898	262	148,00€	53970	286	3.790,00€	54042	303,318	13,00€
53827	320	14,00€	53900	68,80	890,00€	53971	286	468,00€	54043	349	48,00€
53828	320	6,00€	53901	68,80	680,00€	53972	203	550,00€	54044	127	99,00€
53829	320	14,00€	53902	319,320	25,00€	53973	348	284,00€	54045	7	179,00€
53830	320	1.300,00€	53903	214	59,00€	53974	117	38,00€	54046	10	150,00€
53832	320	1,81€	53904	69,80	890,00€	53976	60	9,00€	54047	11	100,00€
53835	321	16,00€	53905	60	7,30€	53977	277	17,50€	54048	12	89,00€
53836	321	16,00€	53906	60	8,65€	53978	175	38,90€	54049	13	88,00€
53838	322	38,00€	53908	60	7,25€	53979	40,80	34,60€	54050	255	980,00€
53839	321	0,25€	53909	60	9,70€	53980	40,80	34,60€	54051	257	39,00€
53840ES	321	6,00€	53910	333	19,00€	53981	277	143,00€	54052	287	1.100,00€
53844	319	2,80€	53911	60	8,80€	53982	277	219,00€	54053	287	248,00€
53845	263	64,00€	53912	67	1.280,00€	53983	167	215,00€	54054	287	268,00€
53849	256	16,10€	53913	67	1.280,00€	53984	317	8,80€	54055	287	220,00€
53850	93,109	14,90€	53914	321,354	75,00€	53985	317	8,80€	54056	287	260,00€
53851	110	88,00€	53915	24,210	65,00€	53986	317	8,80€	54057	287	248,00€
53852	92,110	207,00€	53916	319	3,80€	53987	288,321	9,50€	54058	287	348,00€
53853	110	14,40€	53917	42	9,00€	53988	152	101,00€	54059	287	428,00€
53854	110	27,00€	53919	304	81,00€	53992	333	18,00€	54060	42	6,00€
53855	110	24,80€	53921	169	39,00€	53993	48	77,00€	54061	42	6,00€
53856	92,110	62,00€	53922	169	29,00€	53997	189	48,00€	54066	34,78	83,00€
53857	91,92,111	27,00€	53927	273	66,00€	53999	111	2,00€	54067	286	599,00€
53858	91,92,111	28,80€	53928	21	278,00€	54000	111	2,50€	54068	178	198,00€
53859	92,111	67,00€	53929	273	95,00€	54001	264	285,00€	54069	202	29,50€
53860	92,109	3,65€	53930	350	276,00€	54002	111	3,00€	54070	43	18,00€
53861	92,109	5,45€	53931	351	104,00€	54003	187	104,00€	54071	43	26,50€
53862	254,319	6,00€	53932	57	8,00€	54004	118	23,00€	54072	303,318	38,50€
53863	254,319	3,00€	53934	351	690,00€	54005	41	14,00€	54073	304	70,00€
53864	309	138,00€	53939	66	1.280,00€	54006	69,71	680,00€	54074	304	18,50€
53865	348	48,00€	53940	71,288 290,321	13,20€	54008	111	3,50€	54076	349	9,00€
53866	75	424,00€	53941	71,288 290,321	6,05€	54010	111	4,50€	54078	125	68,00€
53867	74,80	1.095,00€	53942	71,288 290,321	0,50€	54011	111	5,00€	54079	37	83,00€
53868	66,80	1.090,00€	53943	43,77	21,50€	54013	309	35,00€	54081	39	28,00€
53869	67,80	990,00€	53944	43,77	19,50€	54015	60	10,20€	54082	9	188,00€
53870	67,80	990,00€	53945	43,77	18,90€	54016	209	76,00€	54083	51	9,75€
53871	35	60,00€	53946	319	0,83€	54017	166	12,00€	54084	51	13,10€
53872	292	118,00€	53947	282	145,00€	54018	51	9,85€	54085	51	17,80€
53873	253	285,00€	53948	282	324,00€	54019	51	17,90€	54086	51	9,25€
53874	253	398,00€	53949	351	4,50€	54020	349	288,00€	54087	51	17,30€
53875	246	134,00€	53950	351	4,50€	54021	51	13,50€	54088	122	132,00€
53876	238	64,00€				54022	51	9,95€	54089	48	17,50€

REF.	Pg.	RRP	REF.	Pg.	RRP	REF.	Pg.	RRP	REF.	Pg.	RRP
54090	24	56,00€	54159	39	47,00€	54217	235	104,00€	60011	96	175,00€
54091	31,288	441,00€	54160L	127	17,50€	54218	228	142,00€	60012	108	48,00€
54092	223	24,00€	54160R	127	17,50€	54219	221	60,00€	60013	108	80,00€
54093	31	441,00€	54161	127	90,00€	54220	187,222	197,00€	60015	108	138,00€
54097	37	38,90€	54162	127	81,00€	54221	235	111,00€	60016	108	49,00€
54099	48	13,80€	54163	127	80,00€	54222	219	59,00€	60017	108	64,00€
54100	251	265,00€	54164	25	34,00€	54223	231	149,00€	60018	88	306,00€
54101	34	61,00€	54166	304	32,40€	54224	231	64,50€	60019	95	178,00€
54102	297	60,00€	54168	15	49,00€	54225	230	133,00€	60020	94	175,00€
54105	15	33,00€	54169	304	13,80€	54226	244	71,00€	60022	97	470,00€
54106	18,41	89,00€	54170	304	16,50€	54227	221	122,00€	60023	93	212,00€
54108	18	66,00€	54171	350	138,00€	54228	219	187,00€	60024	91	190,00€
54109	17	34,00€	54172	123	81,00€	54229	281	48,00€	60025	91,108	31,60€
54110	35	46,00€	54173	123	87,00€	54230	281	68,00€	60026	91,108	37,90€
54111	163	4,75€	54174	37	139,00€	54231	281	138,00€	60027	103	99,00€
54112	163,197	18,00€	54175	270	34,00€	54232	281	248,00€	60028	92	142,00€
54113	163	7,65€	54176	293	188,00€	54233	290	1.856,00€	60029	104	240,00€
54114	71	248,00€	54177	317	18,95€	54234	71,290	1.856,00€	60030	105	112,00€
54115	39	26,80€	54178	317	18,95€	54235	71,290	1.856,00€	60031	104	142,00€
54116	17	66,00€	54179	317	18,95€	54236	71/290	1.856,00€	60032	99	123,00€
54117	34	74,00€	54180	296	2.400,00€	54237	70	1.887,00€	60033	93	104,00€
54119	39	78,00€	54181	249	25,10€	54238	70	1.887,00€	60034	90	320,00€
54120	37	59,00€	54182	249	34,70€	54239	70	1.887,00€	60035	102	30,00€
54122	115	38,00€	54183	249	38,20€	54240	70	1.887,00€	60037	98	222,00€
54123	115	40,00€	54184	249	44,00€	54241	71,290	120,00€	60038	99	255,00€
54124	115	47,00€	54185	296	390,00€	54245	183	580,00€	60039	103	265,00€
54125	284	152,00€	54186	183	320,00€	54246	294	104,00€	60040	105	440,00€
54126	43	39,00€	54187	37	39,30€	54247	294	99,00€	60041	98	77,00€
54128	104	10,50€	54188	316	19,00€	54248	145	58,00€	60042	100	106,00€
54129	71,290	110,00€	54189	316	19,00€	54249	145	103,00€	60043	100	123,00€
54130	71,290	58,00€	54190	316	19,00€	54250	8	188,00€	60044	89	478,00€
54131	290	58,00€	54191	316	19,00€	54251	139	43,00€	60044C	89	652,00€
54132	71,290	190,00€	54192	316	8,90€	54252	280	199,00€	60045	106	298,00€
54133	122	547,00€	54193	316	8,90€	54253	191	166,00€	70002	346	37,50€
54134	70	1.415,00€	54194	316	8,90€	54254	57	43,00€	70003	346	37,50€
54135	176	82,00€	54195	316	8,90€	54255	257	68,00€	70005	346	42,00€
54136	312	107,00€	54196	297	133,00€	54256	275	48,00€	70009	346	37,50€
54137	260	288,00€	54197	297	118,00€	54257	183,264	318,00€	70011	346	42,00€
54139	188	147,00€	54198	312	59,00€	54258	18	58,00€	70012	346	42,00€
54140	17	36,00€	54199	226	94,00€	54260	231	277,00€	70013	346	44,00€
54141	24	42,00€	54200	244	56,00€	54262	267	88,00€	70014	346	44,00€
54142	62	15,20€	54201	232	37,60€	54263	267	130,00€	70015	346	44,00€
54143	263	249,00€	54202	239	68,00€	54264	267	240,00€	70016	346	44,00€
54144	263	298,00€	54203	239	91,00€	54265	287	1.290,00€	70017	346	44,00€
54145	263	377,00€	54204	232	124,00€	54267	118	9,50€	90003	143	35,20€
54146	263	492,00€	54205	237	49,00€	54270	121	42,00€	90004	143	25,80€
54147	263	198,00€	54206	221	113,00€	54271	121	54,00€	JBMW-BEXP	307	24,50€
54149	38	60,00€	54207	223	38,90€	54299	201	227,00€	METEXP	306,346,353	62,00€
54150	38	23,50€	54208	232	76,00€	60001	101	88,00€	SERIE124	314	710,00€
54151	317	10,90€	54209	232	29,70€	60003	101	110,00€	SERIE262	140,161	199,00€
54152	317	10,90€	54210	230	84,00€	60004	102	79,00€			
54153	317	10,90€	54211	231	74,00€	60005	91	132,00€			
54154	25	37,50€	54212	240	39,40€	60006	92	182,00€			
54155	317	8,80€	54213	238	19,80€	60007	96	170,00€			
54156	317	8,80€	54214	237	96,00€	60008	92	141,00€			
54157	317	8,80€	54215	241	57,00€	60009	94	168,00€			
54158	77	38,00€	54216	234	49,00€	60010	95	170,00€			

SUBSCRIBE TO JBM

We keep you up to speed with JBM news in printed or digital format so that you can stay updated with our developments in the sector.



All the latest news
just a click away!

NEWS

Check our weekly brochure for new additions to the JBM stock. New products, offers, replacements... All the latest news!

NEWSLETTER

Don't miss any offer from JBM! Receive by mail our weekly newsletter with all the news and stock updates. Sign up now!

WHATSAPP

Be the first to know about the latest promotions. Now the news on your WhatsApp!

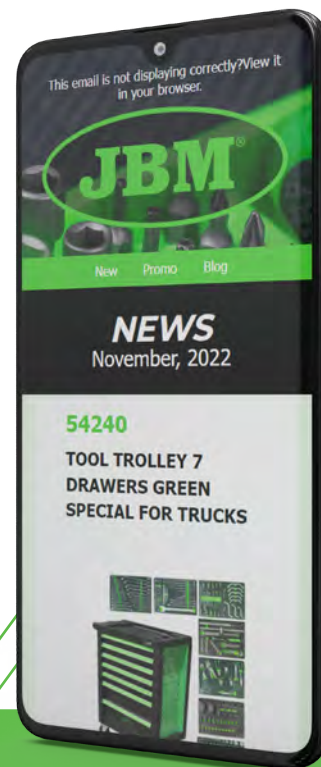

Contact us and we will inform you about how to register in any of our communication channels.

jbm@jbmcamp.com

+34 972 40 57 21 / +34 972 24 55 33



+34 680 240 104

All our promotions and news at just one click

Spare parts of any JBM product

Find your timing tools kit with the OEM code

Order directly to your distributor

Download all our catalogues and brochures direct to your mobile phone

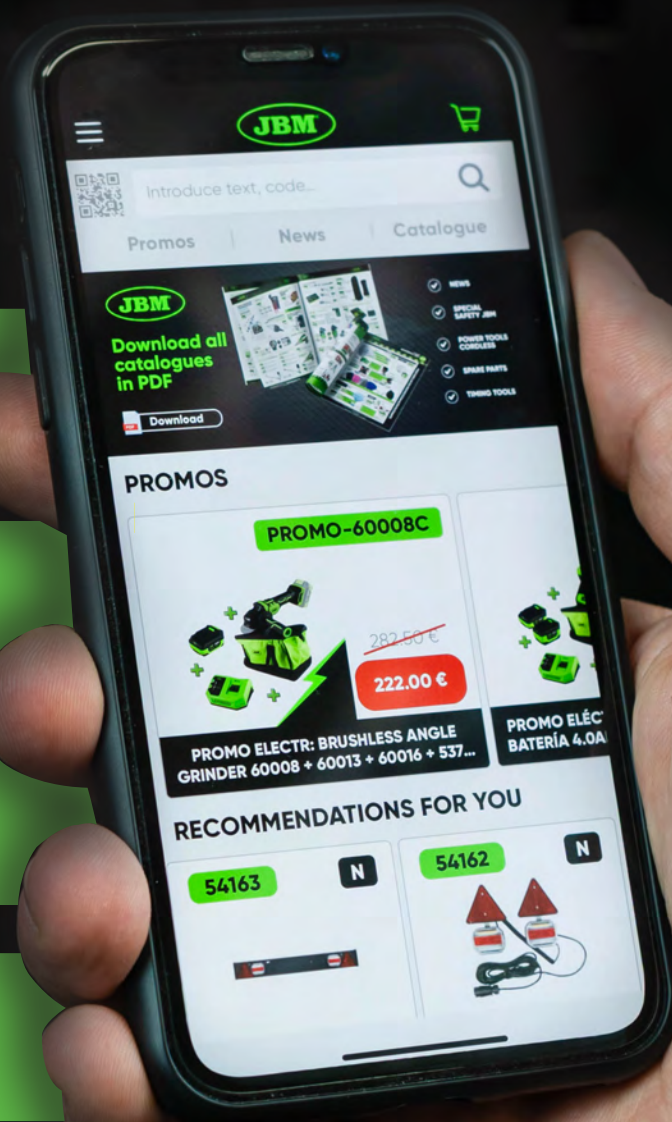

JBM
CLOSER
DOWNLOAD OUR APP





www.jbmcamp.com

 /JBMprofessionaltools

 @jbmtools

 jbmtools

 JBM Campllong S.L.U