

# SPECIAL 2023 WORLDWIDE



Das Werkzeug



SWW23/EN/XX/1

Recommended retail prices (RRPs) excl. VAT. Prices valid from 1 March 2023 until 29 February 2024 at the latest. Prices are subject to change before 29 February 2024. Errors excepted.







179NXXL-8/378 with 378 expert tools

5/3+

Including  
**HiPer**  
6.3 1/4 10 3/8 12 1/2



163-481/194



163-172x50

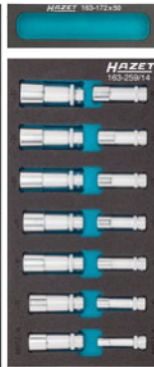

163-259/14

163-478/40



163-515/16



179NXXL-8/378

EAN-No. 4000896232390

4,970.-€  
net

163-527/56



163-380/4

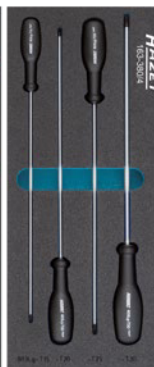

163-479/26



163-382/3

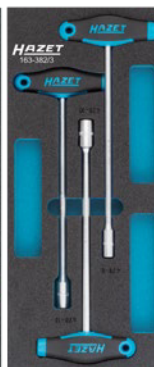

**TOOL TROLLEYS AND WORK BENCHES**  
Assistant® **Made in Germany**

- ▶ Series 179N – suitable for every application: with a narrow width of 518 mm up to XXL format with a width of 1,133 mm and a depth of 642 mm
- ▶ Extremely robust design thanks to dual-wall structure
- ▶ Secure locking and heavy-duty drawer concept
- ▶ Sealed working surfaces protect trolley interior
- ▶ Developed and produced by HAZET "Made in Germany"





## 179NXXL-7/340 with 340 expert tools

Stainless steel work surface

340



5/3+

Including  
**HiPer**  
6.3 1/4 10 3/8 12 1/2



Including  
2128N-1



179NXXL-7/340  
EAN-No. 4000896215072

**3,765.-€\***  
net



163-481/194



163-511/4



163-480/57



163-510/8



163-478/40

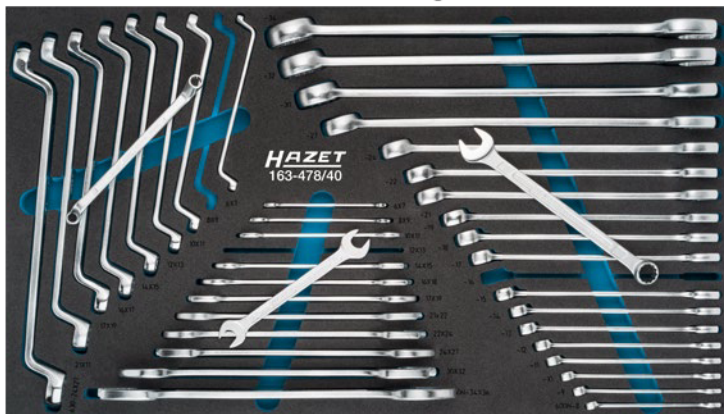

163-509/12





179NXL-8/321 with 321 expert tools

Stainless steel work surface

321

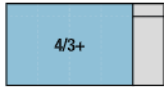

Including  
**HiPer**  
6.3 1/4 10 3/8 12 1/2



Including  
2128N-1



179NXL-8/321  
EAN-No. 4000896224395

**4,180.-€\***  
net



179NXL-8  
Made in Germany  
Wide design: 959 mm

163-549/160



163-478/40



163-480/57



163-479/26



163-522x50

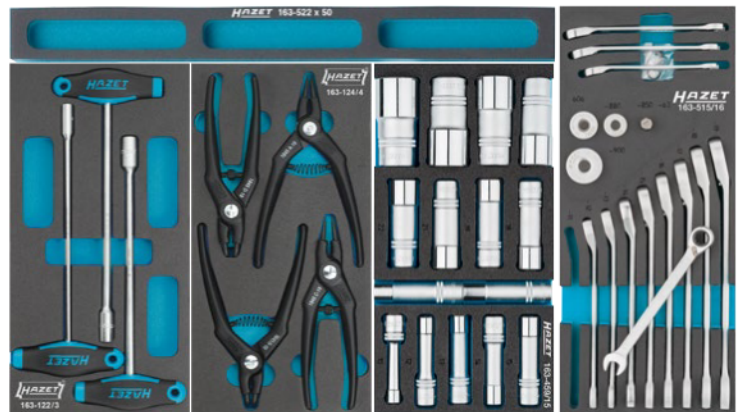

163-122/3

163-124/4

163-459/15

163-515/16



# MIX AND MATCH!

You have the choice between our tool trolley with stainless steel/ plastic work surface or the stable work bench: select our HAZET standard or comfort assortment!

Plastic work surface

179N-8 incl.  
**Standard assortment**

**Basis**

179N-8/228  
EAN-No. 4000896250394

**2,590.-€\***  
net



179N-8  
Made in Germany

179N-8 incl.  
**Comfort assortment**

**Komfort**

179N-8/314  
EAN-No. 4000896250417

**3,490.-€\***  
net

NEW!



Stainless steel work surface  
EDELSTAHL Rostfrei

179NX-8 incl.  
**Standard assortment**

**Basis**

179NX-8/228  
EAN-No. 4000896250431

**2,650.-€\***  
net



179NX-8  
Made in Germany

179NX-8 incl.  
**Comfort assortment**

**Komfort**

179NX-8/314  
EAN-No. 4000896250455

**3,550.-€\***  
net

NEW!



Wood multiplex birch work surface

179NW-7 incl.  
**Standard assortment**

**Basis**

179NW-7/228  
EAN-No. 4000896250479

**3,090.-€\***  
net



179NW-7  
Made in Germany

179NW-7 incl.  
**Comfort assortment**

**Komfort**

179NW-7/314  
EAN-No. 4000896250493

**3,950.-€\***  
net

NEW!





**Basis Standard assortment**

228

Incl. twist drill bits in case 2128N-1, 25 pieces



163-513/122

Assortment



163-526/41

Assortment

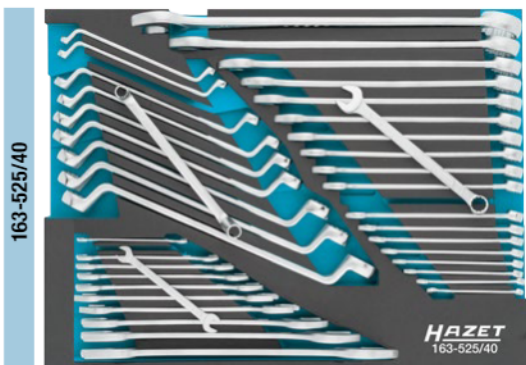

163-525/40

Assortment



**Komfort Comfort assortment**

314

Incl. twist drill bits in case 2128N-1, 25 pieces



163-513/122

Assortment



163-526/41

Assortment

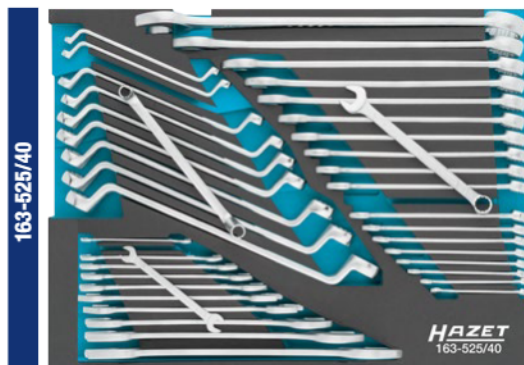

163-525/40

Assortment

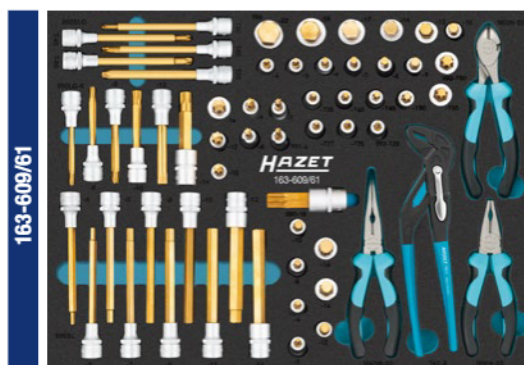

163-609/61

Assortment



**NEW!**



163-372/25

Assortment





## 178N-7/147 with 147 expert tools

147

Plastic work surface

3/3		
-----	--	--

Including  
**HiPer**  
6.3 1/4 12.5 1/2

Assortment



163-466/106



178N-7/147

EAN-No. 4000896205080

**1,399.-€\***  
net



178N-7  
Made in Germany  
781 mm  
498 mm

163-98/17 s 6 – 24 mm



163-95/8 s 6 x 7 – 21 x 22 mm

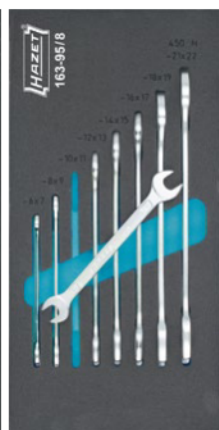

163-330/16



## Tool trolley/work bench accessories



HAZET No.	Designation
179N-33	Paper bin incl. holder
161N-3D/2	Cable drum incl. holder
161N-3D	Cable drum (without holder)
179N-45	Tray holder
179N-35	Can holder
179N-46	Impact wrench holder
179NW-11	Machinist's vice fastening set
179N-42	Laptop holder for 179N · 179NX · 179NXL · 179NXXL
179-35	Can holder
180-24	Document holder
179N-21	Lateral door for 179N · 179NX · 179NXL · 179NXXL

You can find further information at: [www.hazet.de](http://www.hazet.de)



HAZET No.	Designation
180-34	Holder for paper reel
179N-19	Small parts collector
179N-26	Perforated tool panel for 179N · 179NX
179N-75	Machinist's vice fastening for 179N · 179NX · 179NXL · 179NXXL
179NXL-26	Perforated tool panel for 179 NXL
179NXXL-26	Perforated tool panel for 179NXXL
179N-21D	Lateral door for 179NXXL-8D
161N-5D	Socket strip for 179NXXL-8D
179N-50	Bracket for an L-Boxx
179N-51	Bracket set for two L-Boxxes
179N-510	Bracing surface for L-Boxx bracket 179N-51

You can find further information at: [www.hazet.de](http://www.hazet.de)





# HiPer

HIGH PERFORMANCE  
**THE ORIGINAL**  
MADE IN GERMANY

**STATIC AND DYNAMIC – DOUBLE PRECISION IN PERFECTION!**



- ① Pawl
- ② Ratchet wheel
- ③ Shift lever
- ④ Housing
- ⑤ 2-component handle

## HIPER FINE-TOOTH REVERSIBLE RATCHETS

- ▶ Complete range: 1/4" · 3/8" · 1/2"
- ▶ 10 versions, extendable or with safety lock, among other features
- ▶ Maximum power: almost double DIN! (916HP: 1,000 Nm, DIN 512 Nm)
- ▶ High precision: 90 teeth
- ▶ 4° operating angle for restricted spaces
- ▶ Developed and produced by HAZET "Made in Germany"

### Our classics!

1/4" · 3/8" · 1/2"



Made in Germany

	HAZET No.	■	Nm	Length mm	EAN-No. 4000896 +	€* net
①	863HPB	6.3 1/4"	120	116	235346	47.20
②	863HP	6.3 1/4"	120	116	226917	47.20
③	8816HP	10 3/8"	400	200	235063	55.40
④	916HP	12.5 1/2"	1,000	275	213894	59.40
⑤	916HPL	12.5 1/2"	1,000	415	219209	94.50
⑥	916HPLG	12.5 1/2"	1,000	414 – 614	233076	124.–

### Short design!

1/2"



- Short 1/2" design, only 200 mm in compact design as a 3/8" ratchet

Made in Germany

HAZET No.	■	Nm	Length mm	EAN-No. 4000896 +	€* net
916HPK	12.5 1/2"	400	200	244379	61.70

### With safety locking!

1/4" · 3/8" · 1/2"



- ① Pawl
- ② Ratchet wheel with release button
- ③ Shift lever
- ④ Housing
- ⑤ 2-component handle



- Loosening-proof locking thanks to push button actuation
- Attached tools can easily be released by pressing the button with just one hand

Made in Germany

HAZET No.	■	Nm	Length mm	EAN-No. 4000896 +	€* net
863HPS	6.3 1/4"	100	116	237234	52.20
8816HPS	10 3/8"	340	200	237241	62.70
916HPS	12.5 1/2"	850	275	237258	72.80







# HAZET SMART SERIES



AUGMENTED REALITY



HOLDER

- ▶ SmartHolder · SmartCase · SmartRails
- ▶ Concept idea: Maximum number of tools stored in the smallest possible space for the best possible overview
- ▶ Functionally designed tool storage with pleasant feel
- ▶ Tool supplement "To Go": should always be taken along when there is something to be screwed quickly
- ▶ Smart series: developed and produced "Made in Germany"

## 1/4" SmartHolder with 29 screwdriver bits



• Screwdriver bit magazine with kickstand set up using the button on the side

**Contents:**

- 18 screwdriver bits short, 25 mm:
  - s 0.6x4.5 mm
  - PH1 · PH2 · PH3, PZ1 · PZ2 · PZ3
  - s 3 · 4 · 5 · 6 · 8 mm
  - T10 · T15 · T20 · T25 · T30 · T40
- 11 screwdriver bits long, 50 mm:
  - s 0.8x5.5 mm
  - PH2, PZ1 · PZ2
  - s 3 · 4 · 5 · 6 mm
  - T20 · T25 · T30
- Socket, 6-point:
  - s 5.5 · 7 · 8 · 10 · 12 · 13 mm
- Mini solid steel fine-tooth reversible ratchet
- Bit holder with magnet
- Adapter (2x)



Made in Germany

Incl. mini solid steel fine-tooth reversible ratchet 863MB



2300SH-1  
EAN-No. 4000896246588

69.90€<sup>\*</sup><sub>net</sub>

## 1/4" solid steel fine-tooth reversible ratchet

- 90 mm short style
- 60 teeth, 6° operating angle
- With locking spring to securely hold the screwdriver bits



Now also available individually!



NEW!

Comparison 863MB (length: 90 mm) to 863HP (length: 116 mm)

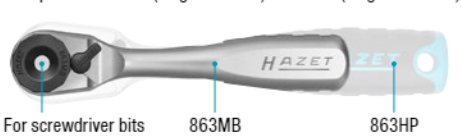

Figure in original size

1:1

Made in Germany  
863MB

EAN-No. 4000896212187

22.95€<sup>\*</sup><sub>net</sub>



## 1/4" SmartHolder with 16 screwdriver bits, short



**Contents:**

- 16 screwdriver bits short, 25 mm:
  - s 0.5 x 4 · 1.2 x 6.5 mm
  - PH1 · PH2 · PH3
  - s 3 · 4 · 5 · 6 mm
  - T10 · T15 · T20 · T25 · T27 · T30 · T40

**NEW!**

16



2304SH-1

EAN-No. 4000896250677

12.90€<sup>\*</sup>  
net



**Contents:**

- 16 screwdriver bits short, 25 mm:
  - s 0.4 x 1.5 · 0.5 x 4 · 1.2 x 6.5 mm
  - PZ1 · PZ2 · PZ3
  - s 3 · 4 · 5 · 6 mm
  - T10 · T15 · T20 · T25 · T30 · T40

**NEW!**

16



2304SH-2

EAN-No. 4000896250653

12.90€<sup>\*</sup>  
net



**Contents:**

- 16 screwdriver bits short, 25 mm:
  - T6 · T7 · T8 · T9 · T10 · T15 · T20 · T25 · T27 · T30 · T40
  - T10H · T15H · T20H · T25H · T30H

**NEW!**

16



2304SH-3

EAN-No. 4000896250639

12.90€<sup>\*</sup>  
net

HOLDER

## 1/4" SmartHolder with 8 screwdriver bits, long



**Contents:**

- 8 screwdriver bits long, 50 mm:
  - PH1 · PH2
  - s 3 · 4 · 5 mm
  - T15 · T20 · T25

**NEW!**

8



2304SH-11

EAN-No. 4000896250615

9.90€<sup>\*</sup>  
net



**Contents:**

- 8 screwdriver bits long, 50 mm:
  - 0.8 x 5.5 mm
  - PZ1 · PZ2
  - s 4 · 5 · 6 mm
  - T20 · T25

**NEW!**

8



2304SH-12

EAN-No. 4000896250592

9.90€<sup>\*</sup>  
net



**Contents:**

- 8 screwdriver bits long, 50 mm:
  - T10 · T15 · T25 · T27 · T30 · T40
  - T20 (2x)

**NEW!**

8



2304SH-13

EAN-No. 4000896250578

9.90€<sup>\*</sup>  
net





# 1/4" SmartCase · width 130 mm

1/4" screwdriver bit and offset screwdriver set



CASE



Assortment  
2200SC-1  
EAN-No. 4000896239252

68.-€  
net

1/4" socket and screwdriver bit set



**HiPer**

Incl. fine-tooth reversible ratchet 863HPB

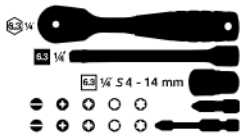

Assortment  
2200SC-2  
EAN-No. 4000896239603

116.50€  
net

1/4" screwdriver bit set



Assortment  
2200SC-3  
EAN-No. 4000896244522

74.-€  
net





1/4" SmartCase · width 210 mm

1/4" screwdriver bit and offset screwdriver set,  
TORX® inside hexagon



CASE

**HiPer**

Incl. fine-tooth reversible  
ratchet 863HPB



Assortment  
2200SC-31  
EAN-No. 4000896244539

139.-€  
net

1/4" socket and screwdriver bit set



**HiPer**

Incl. fine-tooth reversible  
ratchet 863HPB



Assortment  
2200SC-32  
EAN-No. 4000896244546

153.-€  
net





RAIL

# 1/4" SmartRail with 7 slots



## 7 x 1/4" slots, empty

- Dimensions: 245 x 37.4 x 29.2 mm

**NEW!**



Made in Germany  
850SR-7  
EAN-No. 4000896249626

**29.90€\***  
net

## 1/4" hexagon, short 25 mm

- s 5.5 · 6 · 7 · 8 · 10 · 11 · 13 mm

6.3 1/4"

**NEW!**



Made in Germany  
850-SR/7  
EAN-No. 4000896250776

**53.-€\***  
net

## 1/4" hexagon, long 50 mm

- s 5.5 · 6 · 7 · 8 · 10 · 12 · 13 mm

6.3 1/4"

**NEW!**



Made in Germany  
850LG-SR/7  
EAN-No. 4000896250691

**65.-€\***  
net

## 1/4" hexagon, TORX®, short 28 mm

- T30 · T20 · T25
- s 3 · 4 · 5 · 6 mm

6.3 1/4"

**NEW!**



Made in Germany  
8500-SR/7  
EAN-No. 4000896250738

**63.60€\***  
net

## 1/4" E-TORX®, short 25 mm

- s E5 · E6 · E7 · E8 · E10 · E11 · E12

6.3 1/4"

**NEW!**



Made in Germany  
850E-SR/7  
EAN-No. 4000896250714

**55.-€\***  
net

## 1/4" hexagon inch, short 25 mm

- s 3/16" · 1/4" · 5/16" · 3/8" · 7/16" · 1/2" · 9/16"

6.3 1/4"

**NEW!**



Made in Germany  
850A-SR/7  
EAN-No. 4000896250752

**62.-€\***  
net



## 1/2" SmartRail with 5 slots

5 x 1/2" slots, empty

- Dimensions: 245 x 37.4 x 29.2 mm



Made in Germany  
900SR-5  
EAN-No. 4000896244508

34.-€\*  
net

## 1/2" SmartRail with 8 slots

8 x 1/2" slots, empty

- Length: 365 x 37.4 x 29.2 mm



Made in Germany  
900SR-8  
EAN-No. 4000896244515

41.-€\*  
net

Further SmartRail combinations at [www.hazet.de](http://www.hazet.de)



## 1/2" hexagon, long

- s 10 · 13 · 17 · 19 · 22 mm



Made in Germany  
900LG-SR/5  
EAN-No. 4000896245246

102.-€\*  
net

## 1/2" TORX®, short

- s T20 · T25 · T30 · T40 · T45 · T50 · T55 · T60



Made in Germany  
992T-SR/8  
EAN-No. 4000896245376

123.-€\*  
net

## 1/2" impact socket with rim guard

- s 17 mm (3x) · 19 mm (2x)



Made in Germany  
903SLG-SR/5  
EAN-No. 4000896245253

92.-€\*  
net

## 1/2" serration, short

- s M5 · M6 · M8 · M10 · M12 · M14 · M16 · M18



Made in Germany  
990-SR/8  
EAN-No. 4000896245352

134.-€\*  
net

## 1/2" impact socket, long

- s 13 · 17 · 19 · 22 · 24 mm



Made in Germany  
900SLG-SR/5  
EAN-No. 4000896245277

113.-€\*  
net

## 1/2" E-TORX®, short

- s E10 · E11 · E12 · E14 · E16 · E18 · E20 · E24



Made in Germany  
900E-SR/8  
EAN-No. 4000896245383

113.-€\*  
net



## 1/4" telescopic screwdriver bit holder with T-handle

- Bit holders with magnets for securely holding the screwdriver bits
- Flexible length adjustment for universal application
- Telescopic at 10 mm detent points
- Particularly suitable also for very deep screw connections
- 6-fold locking ball on the bayonet fitting for high pressure absorption
- Telescopic tube made from stainless steel
- Blade length from handle: 205 mm / 358 mm
- 6-fold locking ball
- Magnetic force: 1,000 g
- Handle width: 105 mm
- Ergonomically shaped HAZET 2-component T-handle

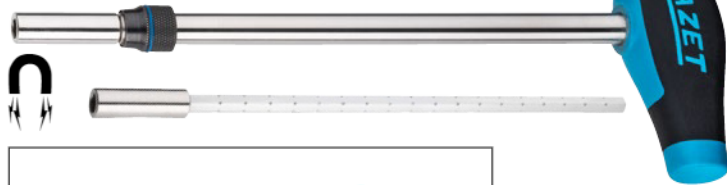

Made in Germany  
866BH-14  
EAN-No. 4000896249336

28.-€\*  
net

## 1/4" double screwdriver bit holder with T-handle

- Bit holders with magnets for securely holding the screwdriver bits
- Flexible use due to two bit holding options in only one tool
- Two bit holders 6.3 mm 1/4"
- Blade lengths from handle: 63 mm / 7.5 mm
- Magnetic force: 1,000 g each
- Handle width: 105 mm
- Ergonomically shaped HAZET 2-component T-handle



Made in Germany  
866BH-4  
EAN-No. 4000896249329

18.40€\*  
net

## 1/4" nut-driver with T-handle

- With locking ball
- 2-component T-handle
- Surface: matt chrome-plated



- Short design**
- Length: 134 mm
  - Blade length: 100 mm



866-4  
EAN-No. 4000896242979

10.90€\*  
net

- Long design**
- Length: 300 mm
  - Blade length: 266 mm



866-10  
EAN-No. 4000896241842

11.50€\*  
net

## 1/4" Screwdriver bit holder extension

- Extra-long shank for deep-lying screw connections in narrow working areas
- Adaptable to any 6.3 mm 1/4" holder
- Outside hexagon 6.3 mm 1/4"
- Magnetic force: 1000 g each
- Length: 212 mm

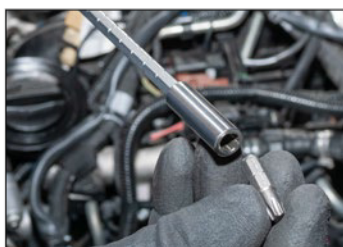

Made in Germany  
2239-9  
EAN-No. 4000896249343

10.70€\*  
net

## 1/4" screwdriver bit holder

- With magnet for secure bit holding
- 2-component handle
- Length: 80 mm



810BMK  
EAN-No. 4000896246090

6.50€\*  
net

### 1/4" mini bit cordless screwdriver

- Max. loosening torque: 4.5 Nm
- Vibration acceleration: 180 m/s<sup>2</sup>
- Revolutions per minute: 180

**Contents:**

- 4 screwdriver bits long, 50 mm:
  - PZ1 · PZ 2
  - s 4 mm
  - T20
- Charging cable: 1.5 m
- Matching holster



**HAZET**  
**ion**

9230B-1  
EAN-No. 4000896250820

**59.90€\***  
net

### 1/4" screwdriver bit set



			s 0.6 x 4.5 · 0.8 x 5.5 · 1 x 6 mm
			PH 1 (3x) · PH 2 (3x) · PH 3
			PZ 1 (3x) · PZ 2 (3x) · PZ 3
			s 3 · 4 · 5 · 6 mm
			T10 · T15 (2x) · T20 (2x) · T25 (2x) · T27 · T30 (2x) · T40 (2x)
			T20H · T30H
			Bit adapter

2240N/36  
EAN-No. 4000896187614

**35.-€\***  
net

### 1/4" screwdriver bit set



			s 0.5 x 4 · 0.6 x 4.5 · 0.8 x 5.5 · 1 x 6 mm
			PH 1 (4x) · PH 2 (4x) · PH 3 (2x)
			PZ 1 (3x) · PZ 2 (3x) · PZ 3
			s 2 · 2.5 · 3 · 4 · 5 · 6 mm
			T6 · T7 · T8 · T9 · T10 · T15 (2x) · T20 (2x) · T25 (2x) · T27 (2x) · T30 (2x) · T40 (2x)
			T10H · T15H · T20H · T25H · T27H · T30H
			Bit adapter

2240N/51  
EAN-No. 4000896187607

**39.-€\***  
net

### 1/4" bit holder



- The perfect supplement to HAZET bit sets
- Special design prevents unwanted rolling away
- With bayonet fitting for a secure hold of bits
- Non-slip HAZET 3-component handle – allows high power transmission
- Length: 98 mm



810BHK  
EAN-No. 4000896237579

**8.80€\***  
net

### 1/4" screwdriver bit adapter



- With bayonet fitting for a secure hold of bits
- Length: 60 mm



2239N-6  
EAN-No. 4000896238934

**8.80€\***  
net



## 1/4" ratcheting bit screwdriver with built-in magazine

- Ratchet function is convertible or for use as normal screwdriver
- Bit magazine is easy to open by pressing a button while pulling
- Comfortable to hold and offers effective impact
- Length: 170 mm (closed, without extension)



Incl. extension (80 mm) 810 R-2

### Set



#### Contents:

- Ratcheting bit screwdriver 810R-1
- Extension 810 R-2
- 12 x bits

			0.5 x 4.0 · 1.2 x 6.5 mm
			PH 1 · PH 2
			PZ 1 · PZ 2
			s 4 · 5 · 6 mm
			T15 · T20 · T25

**810R-3**

EAN-No. 4000896239658

**47.-€\***  
net

### Set



#### Contents:

- Ratcheting bit screwdriver 810R-1
- Extension 810 R-2
- 12 x bits

			0.8 x 5.5 mm
			PH 2 · PH 3
			s 3 · 4 · 5 · 6 mm
			T15 · T20 · T25 · T27 · T30

**810R-4**

EAN-No. 4000896239665

**47.-€\***  
net

## Slot / Phillips

**810/6**

EAN-No. 4000896058808

**19.90€\***  
net

4 x		0.5x3.0 · 0.8x4.0 · 1.0x5.5 · 1.2x6.5 mm
2 x		PH 1 · PH 2

## TORX®

**810T/6**

EAN-No. 4000896204304

**29.90€\***  
net

6 x		T10 · T15 · T20 · T25 · T27 · T30
-----	--	-----------------------------------

## Impact cap



- Blade with hex bolster for use with a wrench, allows application of high separation forces

**810U-1/5**

EAN-No. 4000896179572

**37.90€\***  
net

3 x		0.8x4.5 · 1.0x5.5 · 1.2x7 mm
2 x		PH 1 · PH 2

## HEXAnamic®



- Non-slip HAZET 3-component handle – allows high power transmission

**802/5**

EAN-No. 4000896147359

**31.90€\***  
net

3 x		0.8x4.0 · 1.0x5.5 · 1.2x6.5 mm
2 x		PH 1 · PH 2

### Universal pliers with quick-adjust lever

- Comfortable quick adjustment thanks to tip/step lever function
- Adjustment without re-gripping – one-hand actuation possible
- Length: 260 mm



Made in Germany

760-2

EAN-No. 4000896188451

**39.90€\***  
net

### Pliers set

- Lengths: 250, 165, 160 mm



Made in Germany

1859SPC/3

EAN-No. 4000896179039

**55.90€\***  
net



### Combination wrench set

- Long, slim design
- Slim heads
- Shank with sturdy HAZET double-T-profile
- Box-end head angled at 15°
- Surface: chrome-plated, head polished
- s 8 · 10 · 12 · 13 · 17 · 19 mm



Made in Germany

600N/6

EAN-No. 4000896234554

**69.-€\***  
net

### Ratcheting combination wrench set

- Ratchet function with one-hand reversing switch
- Fine-tooth, 72 teeth · Operating angle 5° · 13° angled
- Surface: chrome-plated
- Output: outside 12-point traction profile
- s 8 · 10 · 13 · 17 · 19 mm



606/5

EAN-No. 4000896177998

**99.-€\***  
net

### 1/4", 3/8", 1/2", 3/4" adapter set

- With locking ball



Made in Germany

958/7

EAN-No. 4000896204595

**66.90€\***  
net





## Quick-clamping puller set

• In display stands

5-piece set:

- 1750-9
- 1750-11
- 1750-14
- 1750-19
- 1750-26



1750/5  
EAN-No. 4000896251476  
**695.-€\***  
net

## 5 Quick-clamping puller

- High strength and rigidity for safe work
- Quick adjustment thanks to "one-nut" fixation per arm
- Two-arm puller
- Inner and outer puller in one
- Quick and easy installation

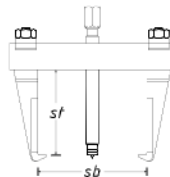

Solid all-steel bridge

Forged arms

**NEW!**



**NEW!**

1750-9  
EAN-No. 4000896249923  
**90.-€\***  
net

Max. t	sb mm	st mm	Spindle mm
2	100	80	M 12 x 1.25 x 140



**NEW!**

1750-11  
EAN-No. 4000896249947  
**95.-€\***  
net

Max. t	sb mm	st mm	Spindle mm
2	135	80	M 12 x 1.25 x 140



**NEW!**

1750-14  
EAN-No. 4000896249961  
**119.-€\***  
net

Max. t	sb mm	st mm	Spindle mm
2	135	135	M 12 x 1.25 x 165



**NEW!**

1750-19  
EAN-No. 4000896249985  
**158.-€\***  
net

Max. t	sb mm	st mm	Spindle mm
10	185	160	M 20 x 1.5 x 248



**NEW!**

1750-26  
EAN-No. 4000896250028  
**233.-€\***  
net

Max. t	sb mm	st mm	Spindle mm
10	260	220	M20 x 1.5 x 319



**NEW!**

1750-34  
EAN-No. 4000896250042  
**357.-€\***  
net

Max. t	sb mm	st mm	Spindle mm
20	345	260	M 27 x 2 x 377



**NEW!**

1750-44  
EAN-No. 4000896250134  
**438.-€\***  
net

Max. t	sb mm	st mm	Spindle mm
20	440	260	M 27 x 2 x 377

## INSULATED HIGH VOLTAGE TOOLS



- ▶ For safe and hazard-free working
- ▶ For use up to 1,000 volts
- ▶ Test report according to IEC 60900
- ▶ Special HAZET 1,000 V protective insulation: two-tone multilayer safety insulation, a red layer on the outside and a yellow layer on the inside



## 3/8", 1/2" high-voltage torque wrench, with protective insulation

- Can be calibrated
- Long service life – high precision
- No more turning back: continuous long-term tests on the 5000 series and 6000 series of HAZET torque wrenches have demonstrated that turning them back to the smallest scale value is not required
- Right/left release with plug-in square, thereby tightening at torque setting both to the right and to the left within the specified tolerance
- Note: adjustment, possible repairs with removal/installation of the KV torque wrench only in the HAZET Service Center



10 3/8"

- 2 – 10 Nm
- Length: 275 mm



Made in Germany  
5108KV  
EAN-No. 4000896235421



366.90€<sup>net</sup>

10 3/8"

- 5 – 25 Nm
- Length: 305 mm



Made in Germany  
5109KV  
EAN-No. 4000896235445



378.90€<sup>net</sup>

125 1/2"

- 20 – 120 Nm
- Length: 420 mm



Made in Germany  
5121KV  
EAN-No. 4000896233397



385.90€<sup>net</sup>



## 179NX-7-RAL3020 70 expert tools with protective insulation

70

Stainless steel work surface  
ROSTFREI



Assortment



3/3+

179NX-7/70KV  
EAN-No. 4000896235483

2,725.-€<sup>net</sup>

163-545/41 10 3/8"

10 3/8" 6 – 22 mm, T10 – T50, LG-T10 – LG-T50



163-172x50



163-229/7



163-542/18 s 7 – 32 mm



163-226/4



## High-voltage tool set, with protective insulation

10 3/8 10 3/8 52

- Joint development with one of the leading car manufacturers and in accordance with the German TÜV SÜD
- Surface: with protective insulation

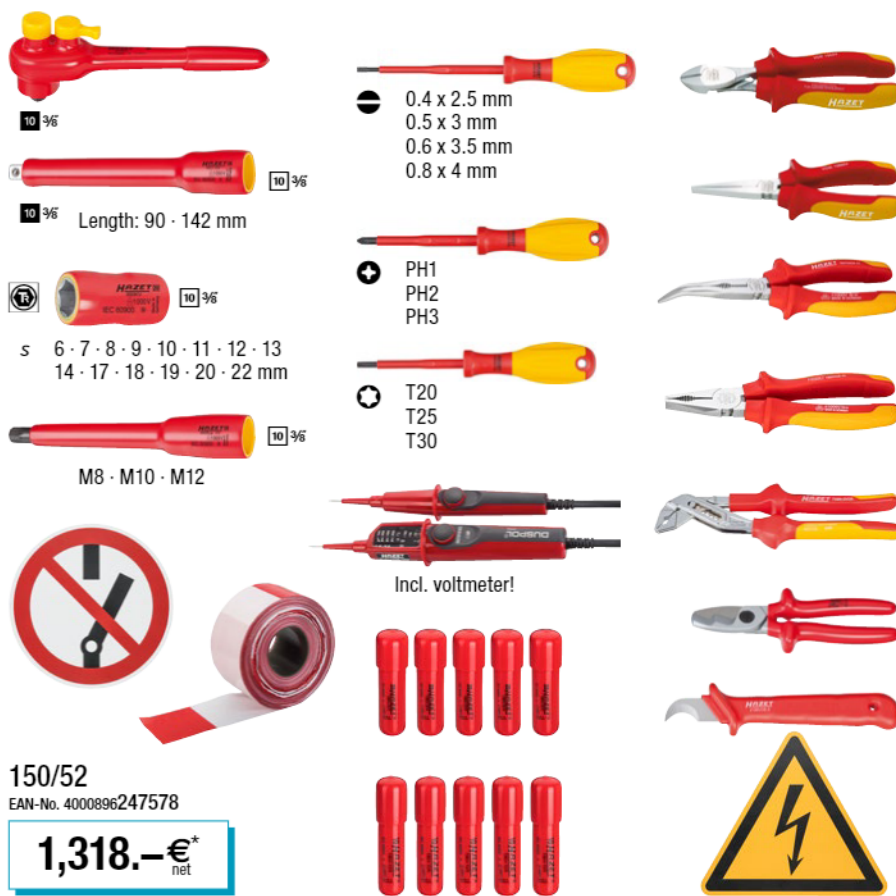

**For hybrid and electric vehicles!**



150/52  
EAN-No. 4000896247578

**1,318.-€\***  
net

## Insulating mat

- For working on high-current parts
- Rubber mat, tested: 50,000 V, according to VDE 0303
- One side smooth and one side anti-slipping, grooved
- Dimensions: 1000 x 1000 x 4.0 mm
- Carrying strap removable

Made in Germany

196VDE-8/2  
EAN-No. 4000896174836

**199.-€\***  
net



## Multimeter

- For measuring voltage, resistance, frequency, capacitance and temperature
- Including measuring tips for clipping into the protective cover
- Including temperature probe from -20°C to 200°C
- DC voltage: 0 – 600 V
- AC voltage: 0 – 600 V
- Direct current: 0 – 10 A
- Alternating current: 0 – 10 A
- Resistance: 0 – 60 MΩ
- Diode test
- During the continuity test, the integrated buzzer signals continuity below 50 Ω
- Frequency: 0 – 10 MHz
- Duty cycle
- Capacitance measurement: 0 – 60 MΩ
- Including 2 x AA batteries



2152-600  
EAN-No. 4000896246762

**118.-€\***  
net

### 3/8" high-voltage tool set, with protective insulation

10 3/8 10 3/8 27

- Universally applicable for all work on high-voltage systems in trade · industry · electric and hybrid vehicles
- Produced according to current DIN specifications – optimum protection and highest level of safety thanks to constant quality control
- Recess for retrofitting with 3/8" torque wrench, with protective insulation 5109KV (see page 21)



0.4x2.5 · 0.8x4 mm  
PH1 · PH2



**Universally applicable for all work on high-voltage systems in trade and industry as well as on electric and hybrid vehicles!**

150/27  
EAN-No. 4000896245550

**610.-€<sup>\*</sup>**  
net

### High-voltage screwdriver set for electricians, with protective insulation

- Ergonomically shaped HAZET 2-component handle (red/yellow)
- Voltmeter (839-1), 220 – 250 V according to DIN VDE 06800-6



810/6VDE  
EAN-No. 4000896179329

**34.20€<sup>\*</sup>**  
net

810VDE 0.4x2.5 · 0.6x3.5 · 0.8x4 mm  
810VDE PH1 · PH2  
839-1 0.5x2.8 mm

### Pliers set, with protective insulation

- In 2-component soft foam insert – suitable for HAZET Assistant



Made in Germany  
163-227/3  
EAN-No. 4000896177868

**119.-€<sup>\*</sup>**  
net



1802VDE-22 Heavy-duty diagonal cutter  
1804VDE-33 Cable shears  
1860VDE-11 Wire strippers

### Tool set for electricians, with protective insulation

- Ergonomically shaped HAZET 2-component handle (red/yellow)
- Voltmeter (839-1), 220 – 250 V according to DIN VDE 06800-6



1802VDE/8  
EAN-No. 4000896234561

**99.-€<sup>\*</sup>**  
net

810VDE 0.4x2.5 · 0.8x4 mm  
839-1 0.5x2.8 mm  
810VDE PH1 · PH2 · PH3  
1802VDE-22 Heavy-duty diagonal cutter  
1841AVDE-22 Snipe nose pliers

### Screwdriver set, with protective insulation

- All screwdrivers 10,000 volts individually tested, safe working guaranteed up to 1,000 volts
- Round blade

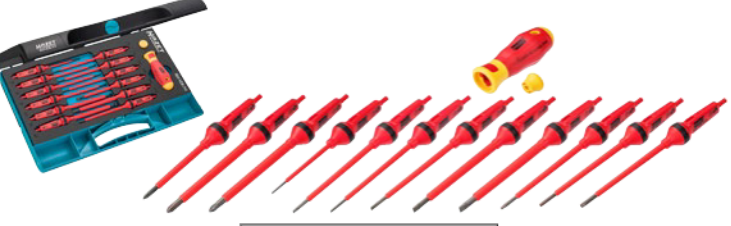

804VDE/14  
EAN-No. 4000896133000

**74.90€<sup>\*</sup>**  
net



2.5x0.4 · 3.0x0.5 · 3.5x0.6 · 4.0x0.8 · 5.5x1.0 · 6.5x1.2 mm  
PH1 · PH2  
PZ2  
T10 · T15 · T20





## SYSTEM 5000-3CT TORQUE WRENCH – OUR CLASSIC WORKSHOP TOOL!

- ▶ Large measuring range: 1 – 800 Nm
- ▶ 15 versions with  $\blacksquare$  1/4" · 3/8" · 1/2" · 3/4" reversible ratchet and screwdriver bit reversible ratchet or insert square 9x12 · 14x18 mm
- ▶ Accuracy:  $\pm$  3% of scale value (5107  $\pm$  4%)
- ▶ HAZET's own service centre for best aftersales service
- ▶ Developed and produced by HAZET "Made in Germany"

**Made in Germany**



With reversible ratchet!

### SYSTEM 5000-3CT

**6.3 1/4" 10 3/8" 12.5 1/2" 20 3/4"**

- Adjustment aid with detent points for optimised operator guidance ensures safe and fast adjustment of the desired torque value by turning the handle
- Trigonometric shape of the blue rotary assembly prevents uncontrolled rolling away
- Accuracy  $\pm$  3% of the scale value (in direction of actuation for right-hand tightening) / 5107-3 CT  $\pm$  4% accuracy of scale value
- Integrated shift lever with free-running function for the measuring ranges 20 – 320 Nm reduces the risk of injury and malfunction (5121-3CT, 5122-3CT, 5123-3CT)
- Tested according to DIN EN ISO 6789-2:2017 with calibration certificate and serial number
- Outside square according to DIN 3120, ISO 1174-1



**Made in Germany**

HAZET No.	Output	Nm range	Release accuracy tolerance %	Length mm	EAN-No. 4000896+	€* net
5107-3CT	<b>6.3</b> 1/4"	1–9	4	234	218875	<b>174.90</b>
5108-3CT	<b>6.3</b> 1/4"	2.5–25	3	234	218882	<b>174.90</b>
5110-3CT	<b>10</b> 3/8"	10–60	3	320	218899	<b>155.90</b>
5111-3CT	<b>10</b> 3/8"	20–120	3	375	235384	<b>156.90</b>
5120-3CT	<b>12.5</b> 1/2"	10–60	3	320	218905	<b>160.90</b>
5121-3CT	<b>12.5</b> 1/2"	20–120	3	421	218912	<b>167.90</b>
5122-3CT	<b>12.5</b> 1/2"	40–200	3	519	219001	<b>176.90</b>
5123-3CT	<b>12.5</b> 1/2"	60–320	3	628	218998	<b>193.90</b>
5143-3CT	<b>12.5</b> 1/2"	100–400	3	790	235407	<b>497.90</b>
5145-3CT	<b>20</b> 3/4"	300–800	3	1271	218929	<b>638.90</b>



With 1/4" reversible ratchet for screwdriver bits

### SYSTEM 5000-3CT

**6.3 1/4"**

- With  $\otimes$  bit reversible ratchet for particularly limited spaces
- For two-wheelers, particularly recommended for aluminium and carbon parts as well as for plastic add-on parts or panels on motorcycles, scooters and bicycles



**Made in Germany**

HAZET No.	Output	Nm range	Release accuracy tolerance %	Length mm	EAN-No. 4000896+	€* net
5107B-3CT	<b>6.3</b> 1/4"	1–9	4	234	244584	<b>174.90</b>
5108B-3CT	<b>6.3</b> 1/4"	2.5–25	3	234	244591	<b>174.90</b>



With insert tool!

### SYSTEM 5000-3CT

**9 x 12 14 x 18**

- With  $\square$  9 x 12- insert tool for most screw connections on the bike with right and left-hand threads
- Left-hand thread screws (manufacturer-dependent), e.g. rear body/swing arm, damper/rocker, derailleur hanger, seat stay and chain wheel nut on e-bike motor
- Simple turning of the versatile HAZET 9 x 12 insert tools (e.g. as open-end or box-end wrenches, square or reversible ratchet for bits) enables torque-accurate tightening of screws with right-hand or left-hand threads with a tolerance of  $\pm$  3%



**Made in Germany**

HAZET No.	Output mm	Nm range	Release accuracy tolerance %	Length mm	EAN-No. 4000896+	€* net
5280-3CT	9x12	2.5–25	3	218	239290	<b>166.90</b>
5290-3CT	9x12	10–60	3	291	228904	<b>156.90</b>
5292-3CT <sup>1</sup>	14x18	40–200	3	484	228911	<b>169.90</b>



<sup>1</sup> Suitable insert tools with 14 x 18 mm output in the 2023 online tool catalogue, from page 327 (printed tool catalogue from page 301)

## PROVEN HAZET HiPer TECHNOLOGY: NOW ALSO IN THE SYSTEM 6000-1CT TORQUE WRENCH!

90 teeth, 4° angular movement

**90**  
4°



Also perfect for working in areas with restricted access

Installation space comparison between torque wrench with 32 teeth and HiPer with 90 teeth



Previously required installation space with 32 teeth:  $\approx 11.25^\circ$

New! With HiPer, required installation space with 90 teeth: just  $\approx 4^\circ$ !

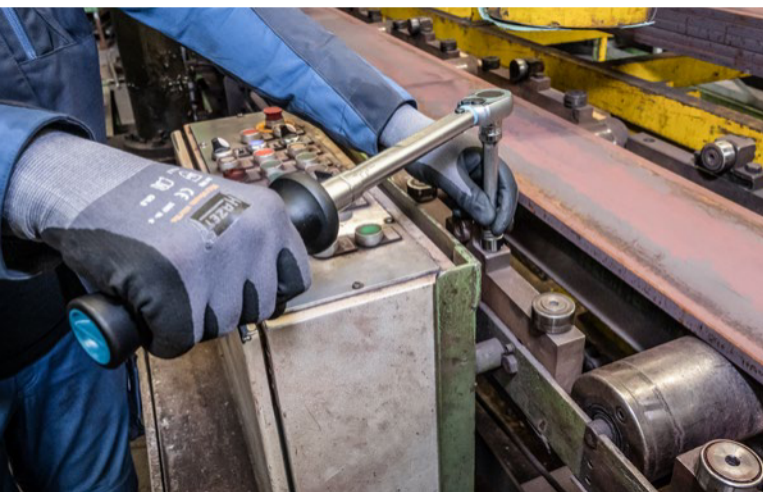
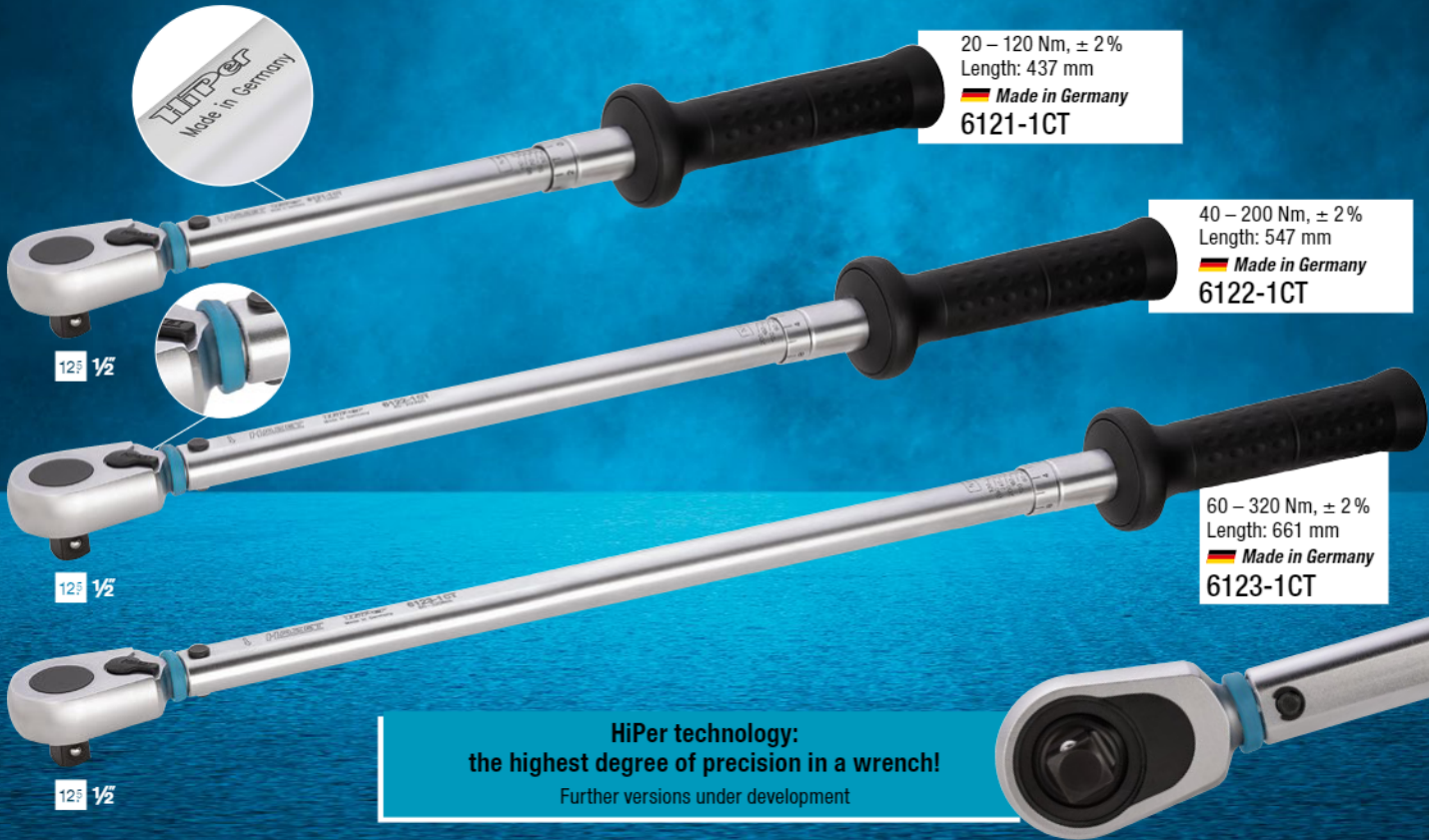





# Twin Turbo

## THE STRONGEST HAZET IMPACT WRENCH SERIES EVER!

- ▶ 1/2", 3/4", 1" Twin Turbo impact wrenches to 4,100 Nm Power
- ▶ Twin Effect – More power in less time!
- ▶ Two air inlets and four air outlets
- ▶ 8-blade air motor with 25% higher impact performance ensures maximum torque
- ▶ HAZET's own service centre for best aftersales service

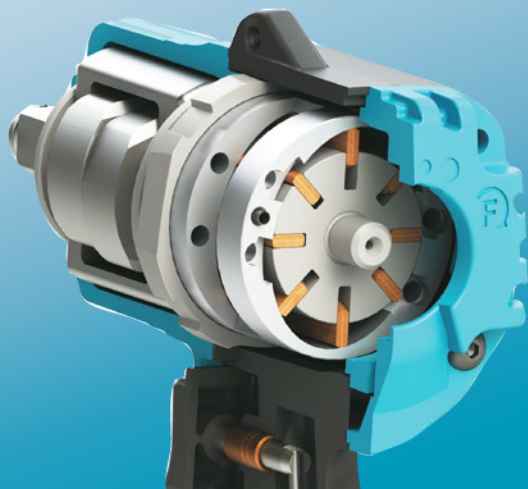

**Short: only 128 mm**

12<sup>5</sup> 1/2

**Max. loosening torque: 2200 Nm**

- Recommended torque: 948 Nm
- Sound power level (at working pressure): 110.7 db(A) Lp W
- Sound pressure level (at working pressure): 99.7 dB(A) Lp A
- Vibration acceleration: 8.69 m/s<sup>2</sup>
- Revolutions per minute: 8300
- Air requirement: 147.2 l/min
- Loosening torque (max) determined with screw size M: 16
- Weight: 1.6 kg
- Length: 128 mm



1/2"



9012TT

EAN-No. 4000896226924

**235.-€\***  
net



**Can be swivelled through 120°**

12<sup>5</sup> 1/2

**Max. loosening torque: 550 Nm**

- Recommended torque: 450 Nm
- Sound power level (at working pressure): 101.1 db(A) Lp W
- Sound pressure level (at working pressure): 90.1 dB(A) Lp A
- Vibration acceleration: 4.89 m/s<sup>2</sup>
- Revolutions per minute: 8000
- Air requirement: 113 l/min
- Loosening torque (max) determined with screw size M: 16
- Weight: 1.3 kg
- Length: 70 mm

1/2"



120°



360°



9012ATT

EAN-No. 4000896234738

**160.-€\***  
net

**Short: only 184 mm**

20 3/4

**Max. loosening torque: 4100 Nm**

- Recommended torque: 1890 Nm
- Sound power level (at working pressure): 110.5 db(A) Lp W
- Sound pressure level (at working pressure): 99.5 dB(A) Lp A
- Vibration acceleration: 10.69 m/s<sup>2</sup>
- Revolutions per minute: 5200
- Air requirement: 243.5 l/min
- Loosening torque (max) determined with screw size M: 32
- Weight: 4.5 kg
- Length: 184 mm

3/4"



9013TT

EAN-No. 4000896227143

**620.-€\***  
net



Long spindle: 186 mm

20 3/4"

3/4"



**Max. loosening torque: 3800 Nm**

- Recommended torque: 1758 Nm
- Sound power level (at working pressure): 113.5 db(A) Lp W
- Sound pressure level (at working pressure): 102.5 dB(A) Lp A
- Vibration acceleration: 9.02 m/s<sup>2</sup>
- Revolutions per minute: 5200
- Air requirement: 243 l/min
- Loosening torque (max) determined with screw size M: 32
- Weight: 5.5 kg
- Length: 184 mm
- Length of spindle: 186 mm



9013LGTT

EAN-No. 4000896232277

680.-€\*  
net

Strong and handy

25 1"

**Max. loosening torque: 4100 Nm**

- Recommended torque: 1898 Nm
- Sound power level (at working pressure): 112.9 db(A) Lp W
- Sound pressure level (at working pressure): 101.9 dB(A) Lp A
- Vibration acceleration: 19.11 m/s<sup>2</sup>
- Revolutions per minute: 5200
- Air requirement: 235 l/min
- Loosening torque (max) determined with screw size M: 32
- Weight: 4.6 kg
- Length: 184 mm

1"



9014TT

EAN-No. 4000896234684

685.-€\*  
net



Long spindle: 240 mm

25 1"

1"



**Max. loosening torque: 3850 Nm**

- Recommended torque: 1627 Nm
- Sound power level (at working pressure): 113.5 db(A) Lp W
- Sound pressure level (at working pressure): 102.5 dB(A) Lp A
- Vibration acceleration: 17.31 m/s<sup>2</sup>
- Revolutions per minute: 4600
- Air requirement: 235 l/min
- Loosening torque (max) determined with screw size M: 32
- Weight: 5.9 kg
- Length: 130 mm
- Length of spindle: 240 mm



9014LGTT

EAN-No. 4000896234677

730.-€\*  
net





**Max. loosening torque: 461 Nm**

10 3/8"

**Short design!**

- Compact design for work in confined spaces – only 92 mm short
- Single hammer striking mechanism
- Revolutions per minute: 6500
- Air requirement: 85.2 l/min
- Sound pressure level (at working pressure): 90.3 dB(A) Lp A
- Vibration acceleration: 7.78 m/s<sup>2</sup>
- Weight: 1.2 kg

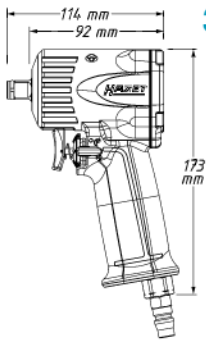

**3/8"**



9011M  
EAN-No. 4000896201570

HAZET No.	Silicone protective cover	EAN-No.	€* net
9012M-S	Suitable for 9011M	202232	6.10

**185.-€\*  
net**

**Max. loosening torque: 1,200 Nm**

12<sup>5</sup> 1/2"

**Extra short -  
Our top seller**

- Compact design for work in confined spaces – only 80 mm short
- Single hammer striking mechanism
- Revolutions per minute: 8800
- Air requirement: 127.4 l/min
- Sound pressure level (at working pressure): 92.2 dB(A) Lp A
- Vibration acceleration: 13.49 m/s<sup>2</sup>
- Weight: 1.3 kg

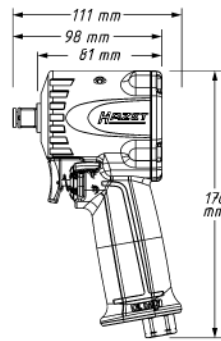

**1/2"**



9012M-1  
EAN-No. 4000896218356

HAZET No.	Silicone protective cover	EAN-No.	€* net
9012M-1-S	Suitable for 9012M-1	222735	6.05

**173.-€\*  
net**

**Max. loosening torque: 850 Nm**

12<sup>5</sup> 1/2"

- High performance pin clutch mechanism
- Revolutions per minute: 7000
- Air requirement: 127.4 l/min
- Sound pressure level (at working pressure): 92.1 dB(A) Lp A
- Vibration acceleration: 7.42 m/s<sup>2</sup>
- Weight: 2.6 kg



**1/2"**

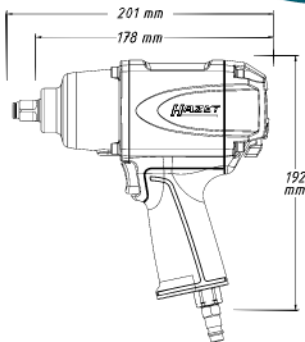

**Higher power development thanks  
to new development of the air  
motor!**

9012SPC  
EAN-No. 4000896119639

HAZET No.	Silicone protective cover	EAN-No.	€* net
9012SPC-S	Suitable for 9012SPC	222476	8.50

**149,90€\*  
net**

**Max. loosening torque: 1,890 Nm**

20 3/4"

- High performance twin hammer mechanism
- Revolutions per minute: 7300
- Air requirement: 153 l/min
- Sound pressure level (at working pressure): 104 dB(A) Lp A
- Vibration acceleration: 7.47 m/s<sup>2</sup>
- Weight: 2.1 kg



**3/4"**

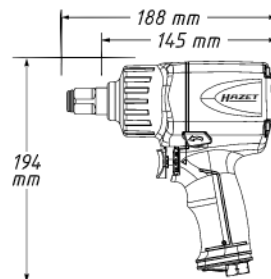

**3/4" impact wrench in  
1/2" housing size!**

9013M  
EAN-No. 4000896212347

HAZET No.	Silicone protective cover	EAN-No.	€* net
9013M-S	Suitable for 9013M	222735	6.05

**392.-€\*  
net**

## Max. loosening torque: 40 Nm

- For manual retightening with torque values > 60 Nm
- Sound power level (at working pressure): 101 db(A) Lp W
- Sound pressure level (at working pressure): 90 dB(A) Lp A
- Vibration acceleration: 3.30 m/s<sup>2</sup>
- Revolutions per minute: 250
- Air requirement: 72 l/min
- Weight: 0.5 kg
- Length: 150 mm



1/4"

6.3 1/4"

### Mini version

9020P-2  
EAN-No. 4000896184323

155.-€\*  
net

## Max. loosening torque: 54 Nm

- For manual retightening with torque values > 260 Nm
- Sound power level (at working pressure): 103 db(A) Lp W
- Sound pressure level (at working pressure): 92 dB(A) Lp A
- Vibration acceleration: 3.90 m/s<sup>2</sup>
- Revolutions per minute: 300
- Air requirement: 103 l/min
- Weight: 0.5 kg
- Length: 150 mm



3/8"

10 3/8"

### Mini version

9021P-2  
EAN-No. 4000896184545

155.-€\*  
net

## Max. loosening torque: 108 Nm

- For manual retightening with torque values > 400 Nm
- Sound power level (at working pressure): 110 db(A) Lp W
- Sound pressure level (at working pressure): 99 dB(A) Lp A
- Vibration acceleration: 9.10 m/s<sup>2</sup>
- Revolutions per minute: 280
- Air requirement: 113 l/min
- Weight: 1.24 kg
- Length: 258 mm



1/2"

12.5 1/2"

### Closed head

9022P-2  
EAN-No. 4000896184538

215.-€\*  
net

## Max. loosening torque: 102 Nm

- For manual retightening with torque values > 270 Nm
- Sound power level (at working pressure): 98 db(A) Lp W
- Sound pressure level (at working pressure): 91 dB(A) Lp A
- Vibration acceleration: 4.53 m/s<sup>2</sup>
- Revolutions per minute: 400
- Air requirement: 113 l/min
- Weight: 1.28 kg
- Length: 280 mm



1/2"

12.5 1/2"

### Pin clutch mechanism

9022SR-1  
EAN-No. 4000896170593

221.-€\*  
net

## Max. loosening torque: 120 Nm

- For manual retightening with torque values > 400 Nm
- Sound power level (at working pressure): 102.2 db(A) Lp W
- Sound pressure level (at working pressure): 91.2 dB(A) Lp A
- Vibration acceleration: 4.87 m/s<sup>2</sup>
- Revolutions per minute: 200
- Air requirement: 107.6 l/min
- Weight: 1.55 kg
- Length: 285 mm



1/2"

12.5 1/2"

### 360° operating lever

9022-360  
EAN-No. 4000896209781

226.-€\*  
net

## Power in watts: 224 watts

- With the open 17 mm inside hexagon it is also possible to work on extra long threads
- Can be used for 1/4", 3/8" and 1/2" by replacing the ratchet heads
- Sound power level (at working pressure): 93.4 db(A) Lp W
- Sound pressure level (at working pressure): 82.8 dB(A) Lp A
- Vibration acceleration: 1.80 m/s<sup>2</sup>
- Revolutions per minute: 400
- Air requirement: 84 l/min
- Weight: 0.48 kg
- Length: 160 mm

17 mm



10 3/8"

6.3 1/4"

6.3 1/4"

### Mini and multifunction

4

9023M-1  
EAN-No. 4000896227112

175.-€\*  
net



## Micro die grinder

- Power: 190 watts
- Precise processing of workpieces even in areas with very restricted access
- Collet chuck: 3 mm
- Sound power level (at working pressure): 86.4 dB(A) Lp W
- Sound pressure level (at working pressure): 80.4 dB(A) Lp A
- Vibration acceleration: 0.80 m/s<sup>2</sup>
- Revolutions per minute: 60000
- Air requirement: 75 l/min
- Hose length: 1500 mm
- Weight: 0.23 kg
- Length: 132 mm

**KEVLAR**



**NEW!**



Long service life thanks to Kevlar blades!



9032MK

EAN-No. 4000896248346

**109.-€\***  
net



HAZET No.	Accessories	Quantity	EAN-No. 4000896 +	€* net
9032-03/5	Carbide milling pin set, 3 mm	5	222483	85.10

## Mini die grinder

- Power: 224 watts
- 6 mm collet chuck with 3 mm adapter to accommodate both grinding pad dimensions
- Quiet operation: integrated exhaust hose removes exhaust air from the workpiece and dampens the sound
- Sound power level (at working pressure): 85.8 db(A) Lp W
- Sound pressure level (at working pressure): 78.7 dB(A) Lp A
- Vibration acceleration: 1.80 m/s<sup>2</sup>
- Revolutions per minute: 30000
- Air requirement: 43.7 l/min
- Weight: 0.38 kg
- Hose length: 1500 mm
- Tool length: 150 mm



9032M-36

EAN-No. 4000896209606

**154.-€\***  
net



HAZET No.	Accessories	Quantity	EAN-No. 4000896 +	€* net
9032-03/5	Carbide milling pin set, 3 mm	5	222483	85.10
9032-06/3	Carbide milling pin set, 6 mm	3	222667	77.90

## Micro die grinder, angled

- Power: 186.4 watts
- Sound power level (at working pressure): 78.1 db(A) Lp W
- Sound pressure level (at working pressure): 77.7 dB(A) Lp A
- Vibration acceleration: 0.37 m/s<sup>2</sup>
- Revolutions per minute: 70000
- Air requirement: 150 l/min
- Weight: 0.23 kg
- Hose length: 1500 mm
- Tool length: 150 mm



9032M-53

EAN-No. 4000896246205

**199.-€\***  
net



HAZET No.	Accessories	Quantity	EAN-No. 4000896 +	€* net
9032-03/5	Carbide milling pin set, 3 mm	5	222483	85.10

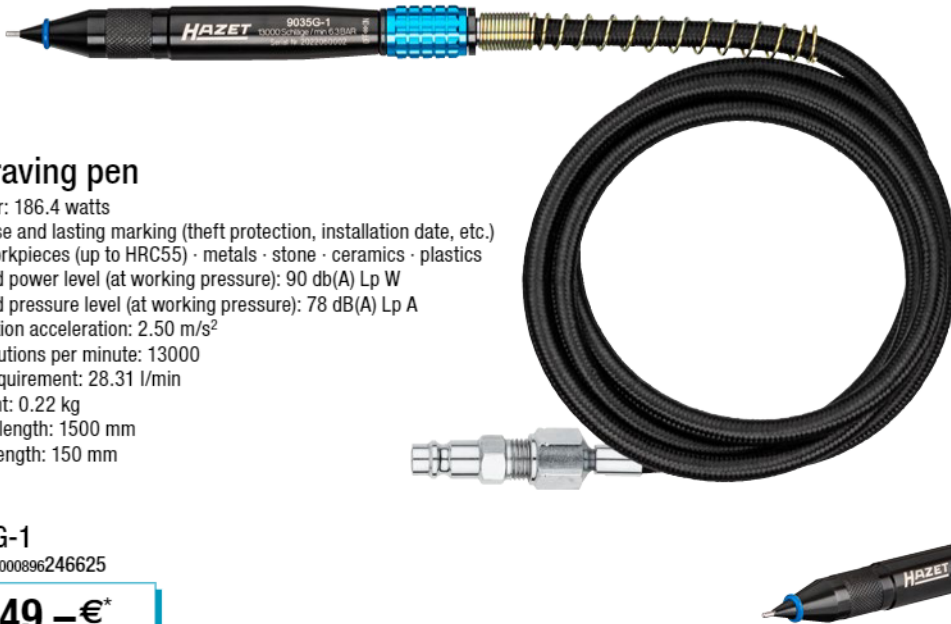

## Engraving pen

- Power: 186.4 watts
- Precise and lasting marking (theft protection, installation date, etc.) on workpieces (up to HRC55) · metals · stone · ceramics · plastics
- Sound power level (at working pressure): 90 db(A) Lp W
- Sound pressure level (at working pressure): 78 db(A) Lp A
- Vibration acceleration: 2.50 m/s<sup>2</sup>
- Revolutions per minute: 13000
- Air requirement: 28.31 l/min
- Weight: 0.22 kg
- Hose length: 1500 mm
- Tool length: 150 mm

9035G-1

EAN-No. 4000896246625

**149.-€\***  
net



## Die grinder, straight design

- Power: 700 watts
- Grinding, polishing, burnishing and deburring
- Sound power level (at working pressure): 98 db(A) Lp W
- Sound pressure level (at working pressure): 87 db(A) Lp A
- Vibration acceleration: 0.46 m/s<sup>2</sup>
- Revolutions per minute: 22000
- Air requirement: 150 l/min
- Weight: 0.8 kg
- Length: 157 mm



9032N-1

EAN-No. 4000896189359

**115.-€\***  
net

HAZET No.	Accessories	EAN-No. 4000896 +	€* net
9030R-01/2	Eraser disc, max. rpm 4,000, Ø 98 mm, thickness: 15 mm	241804	9.90

## Bristle grinder set

- For using with various grinding media to remove rust, paint, adhesive and sealing residues or to clean metal surfaces and weld seams when using various abrasive media
- Roloc™ quick-change system allows the abrasive media to be changed quickly and easily without needing to use any extra tools

- Sound power level (at working pressure): 86 db(A) Lp W
- Sound pressure level (at working pressure): 75 db(A) Lp A
- Vibration acceleration: 3.11 m/s<sup>2</sup>
- Revolutions per minute: 15000
- Air requirement: 79 l/min
- Weight: 0.54 kg
- Length: 112 mm
- Height: 152 mm



**17 pieces**



HAZET No.	Spare parts	Quantity	EAN-No. 4000896 +	€* net
9033-11-015	① Bristle grinding disc, 1/4" UNC Roloc®, Ø 50 mm	1	222841	12.10
9033-11-020/4	② Strip wheel set, Ø 50.8 mm Roloc®, hard version	4	222834	20.80
9033-11-030/4	③ Strip wheel set, Ø 50.8 mm Roloc®, soft version	4	222728	18.60
9033-11-036/2	④ Spare bristle grinder set, purple, Ø 50 mm Roloc®, grain size: 36	2	222872	35.-
9033-11-050/2	⑤ Spare bristle grinder set, green, Ø 50 mm Roloc®, grain size: 50	2	222865	27.50
9033-11-0120/2	⑥ Spare bristle grinder set, white, Ø 50 mm Roloc®, grain size: 120	2	222858	36.-

9033-11/17

EAN-No. 4000896222575

**190.-€\***  
net



## Belt sander

- Power in watts: 417.6 watts
- Incl. hex-head wrench for fine adjustment of the belt and angle setting in the handle
- Sound power level (at working pressure): 94.8 db(A) Lp W
- Sound pressure level (at working pressure): 83.8 dB(A) Lp A
- Vibration acceleration: 1.88 m/s<sup>2</sup>
- Revolutions per minute: 19000
- Air requirement: 94 l/min
- Weight: 0.81 kg
- Length: 291.4 mm



9033N-4  
EAN-No. 4000896210183



182.-€<sup>\*</sup>  
net

HAZET No.	Spare parts	□	EAN-No. 4000896 +	€ <sup>*</sup> net
9033-480/10	Abrasive belt set, grain size 80	10	139101	15.-
9033-4100/10	Abrasive belt set, grain size 100	10	139118	15.-
9033-4120/10	Abrasive belt set, grain size 120	10	139125	15.-

## Right-angle grinder

- Power in watts: 671 watts
- For grinding wheels 0.8–6 mm thick
- Sound power level (at working pressure): 96 db(A) Lp W
- Sound pressure level (at working pressure): 85 dB(A) Lp A
- Vibration acceleration: 6.50 m/s<sup>2</sup>
- Revolutions per minute: 12000
- Air requirement: 113 l/min
- Weight: 2 kg
- Length: 239 mm



9033N-7  
EAN-No. 4000896205547

247.-€<sup>\*</sup>  
net

HAZET No.	Spare parts	□	EAN-No. 4000896 +	€ <sup>*</sup> net
9233-010/5	Cut-off wheel set (125x1x22.23 mm)	5	219063	7.80
9233-010/25	Cut-off wheel set (125x1x22.23 mm)	25	219070	33.-
9233-011/10	Rough grinding wheel set (125x6x22.23 mm)	10	219087	23.50

## Cut-off grinder

- Power in watts: 700 watts
- Sound power level (at working pressure): 100.5 db(A) Lp W
- Sound pressure level (at working pressure): 89.5 dB(A) Lp A
- Vibration acceleration: 3.65 m/s<sup>2</sup>
- Revolutions per minute: 14000
- Air requirement: 113 l/min
- Weight: 1.7 kg
- Length: 371 mm



9033P-8  
EAN-No. 4000896190515



260.-€<sup>\*</sup>  
net

HAZET No.	Spare parts	□	EAN-No. 4000896 +	€ <sup>*</sup> net
9033P-08/5	Cut-off wheel set	5	201549	15,50
9033P-08/25	Cut-off wheel set	25	201402	59,50

## Cut-off grinder

- Power in watts: 522 watts
- For cut-off wheels 76 x 2.1 x 10 mm
- Including 1 cut-off wheel
- Sound power level (at working pressure): 88 db(A) Lp W
- Sound pressure level (at working pressure): 88 dB(A) Lp A
- Vibration acceleration: 1.80 m/s<sup>2</sup>
- Revolutions per minute: 2000–18000
- Air requirement: 114 l/min
- Weight: 0.9 kg
- Length: 207 mm



9033-10  
EAN-No. 4000896196371

134.70€<sup>\*</sup>  
net

HAZET No.	Spare part	□	EAN-No. 4000896 +	€ <sup>*</sup> net
9033-010/5	Cut-off wheel set	5	199969	24.30

## Mini orbital sander set

- Power in watts: 238 watts
- With hook and loop fastener
- Sound power level (at working pressure): 93 db(A) Lp W
- Sound pressure level (at working pressure): 80 dB(A) Lp A
- Vibration acceleration: 0.77 m/s<sup>2</sup>
- Revolutions per minute: 15000
- Air requirement: 79 l/min
- Weight: 0.64 kg
- Length: 107 mm

- 36-piece set, contents:
  - 1 orbital sander
  - 2 grinding discs 50 mm (2") and 75 mm (3")
  - 10 grinding pads each, grain size 320 / 400 / 600
  - 1 Adjusting wrench



9033N-5  
EAN-No. 4000896205585

199.-€<sup>\*</sup>  
net

36



## Die grinder, angled

- Power in watts: 224 watts
- Grinding, polishing, burnishing and deburring, particularly in areas that are difficult to access
- Continuous speed regulation via setting wheel on the upper side of the device
- 360° exhaust (adjustable)
- Weight: 0.5 kg
- Length: 155 mm



9032N-5

EAN-No. 4000896198788

**139.-€\***  
net

## Orbital sanders

- Power in watts: 375 watts
- Dust extraction
- Suction hose (2.0 m) and collection bag included
- Grinding disc with 15 bore holes, Ø 150 mm with hook and loop fastener
- Air requirement: 57 l/min
- Weight: 0.9 kg
- Length: 231 mm



9033-2

EAN-No. 4000896156337

**249.-€\***  
net

## Mini disc sander, angled

- Power in watts: 224 watts
- Heavy-duty multi-bearing gearbox with a 2.5-times longer service life compared to conventional gearboxes
- Roloc® quick-change system: Combine with many abrasive media Fast, tool-free, easy change of abrasives
- Grinding disc diameter: 50 mm
- Weight: 0.44 kg
- Length: 133 mm



9033M-11

EAN-No. 4000896227129

**145.-€\***  
net

## Mini polisher

- Power in watts: 224 watts
- Heavy-duty multi-bearing gearbox with a 2.5-times longer service life compared to conventional gearboxes
- Grinding disc Ø 50 mm
- Weight: 0.6 kg
- Length: 151 mm



9033M-9

EAN-No. 4000896227235

**162.-€\***  
net

## Mini polisher set

- Power in watts: 238 watts
- Sound power level (at working pressure): 96.76 dB(A) Lp W
- Sound pressure level (at working pressure): 85.76 dB(A) Lp A
- Vibration acceleration: 2.43 m/s<sup>2</sup>
- Revolutions per minute: 3200
- Air requirement: 91 l/min
- Weight: 0.72 kg
- Length: 150 mm

### 6-piece set, contents:

- 1 polisher
- 1 wet grinding pad, Ø 75 mm
- 1 plastic pad, hard (yellow)
- 1 plastic pad, soft (white)
- 1 lambskin
- 1 adjusting wrench



9033N-9

EAN-No. 4000896205561

**199.-€\***  
net

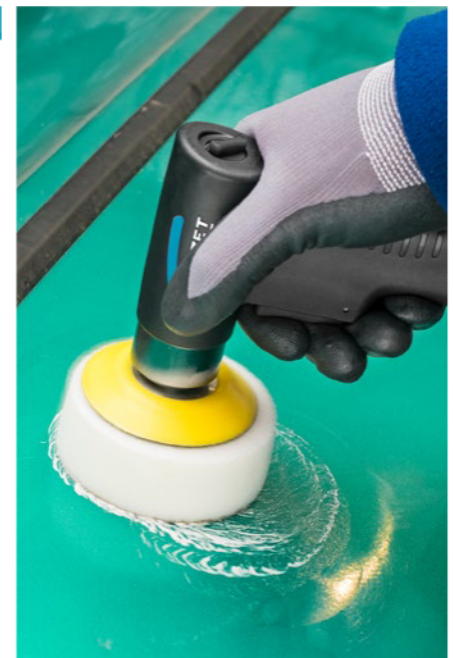



## Vibration chisel set

- Vibration applications on screw connections seized by rust
- Strike rate adjustable in 9 levels up to 2600 strikes/min
- Including keyless drill chuck
- Length: 211 mm
- Height: 189 mm

**9035V/5**

EAN-No. 4000896213368

**284.-€\***  
net

HAZET No.	Spare parts	■	EAN-No. 4000896+	€* net
9035V-01	Semi-circular vibration chisel	1	214181	24.50
9035V-02	Circular vibration chisel	1	214174	24.50
9035V-03	Vibration chisel	1	214167	30.30
9035V-04	Vibration chisel	1	214150	30.30

**5**

## Chisel hammer set

- Detaching car body sheets with compressed air and for industrial application
- Strike rate adjustable in 9 levels up to 2600 strikes/min
- Including keyless drill chuck
- Length: 211 mm
- Height: 189 mm



**9035H/6**

EAN-No. 4000896214655

**221.-€\***  
net

HAZET No.	Spare parts	■	EAN-No. 4000896+	€* net
9035H-01	Flat chisel	1	214136	12.90
9035H-02	Sheet metal cutting chisel	1	213924	12.90
9035H-03	Pointed chisel	1	214198	12.90
9035H-04	Rivet cutting chisel	1	214143	12.90
9035H-05	Curve cutting chisel	1	214525	12.90

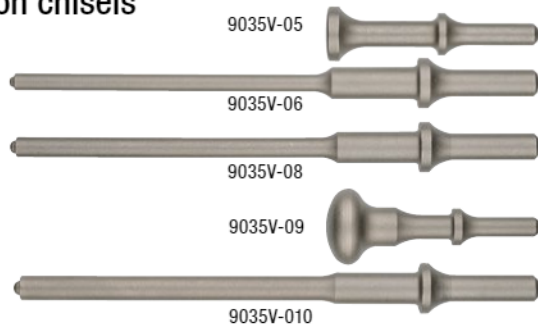
## More vibration chisels



HAZET No.	Designation	■	EAN-No. 4000896+	€* net
9035V-05	Flat vibration chisel	1	227266	17.80
9035V-06	Vibration drift pin 6 mm	1	227259	14.35
9035V-08	Vibration drift pin 8 mm	1	227297	14.35
9035V-09	Curved vibration chisel	1	227280	50.90
9035V-010	Vibration drift pin 10 mm	1	227273	14.25

## Sabre saw

- Support frame, adjustable in height, suitable for double-walled sheet steel
- Increased efficiency with reduction of weight, air consumption, noise generation and vibration
- Direction of air exhaust adjustable
- Suitable for cutting small radii
- Cutting capacity aluminium: 4 mm
- Cutting capacity sheet steel: 3 mm
- Strokes/min.: 9500
- Particularly suitable for cleaning sensor modules etc., due to file blade socket (included in delivery)

**9034P-2**

EAN-No. 4000896218288

**205.-€\***  
net

HAZET No.	Designation	■	EAN-No. 4000896+	€* net
9034P-R/5	Reciprocal saw blades, chamfered teeth, length: 153 mm	5	218318	27.20
9034P-050/5	File set, length: 153 mm	5	218349	26.90
9034P-018/5	Saw blades, 93 mm, 18 teeth	5	225958	17.90
9034P-024/5	Saw blades, 93 mm, 24 teeth	5	225965	17.90
9034P-032/5	Saw blades, 93 mm, 32 teeth	5	225989	17.90

**11**

## Mini needle scaler

- Gentle cleaning of soiled / rusted parts especially cleaning of brake systems etc.
- Extremely slim / short pin form and free needles allow you to reach difficult to access areas as well
- 13 thin stainless steel needles (∅ 1.3 mm) ensure damage-free processing and highly fine surface structure
- 3000 impacts/min
- Length: 236 mm

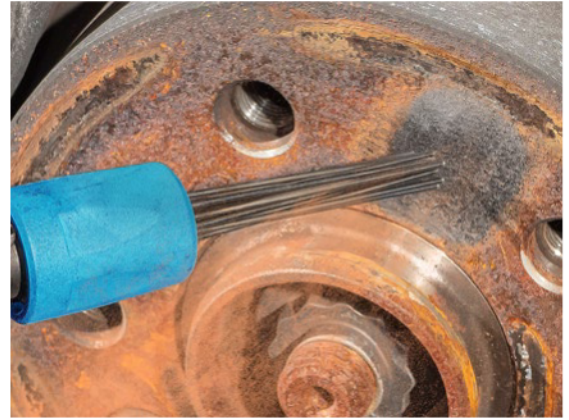

9035M-5

EAN-No. 4000896232284

**222.-€\***  
net

HAZET No.	Designation		EAN-No. 4000896+	€* net
9035M-050	Spare needles for mini needle scaler 9035 M-5, ∅ 1.3 mm	13	233205	41.50

## Needle scaler

- Precisely removing rust and such
- Pistol shape
- Adjustable needle cover enables maximum utilisation of needles
- Two-piece housing design for easy maintenance
- 19 needles, ∅ 3 mm
- 3,200 impacts/min
- Length: 321 mm

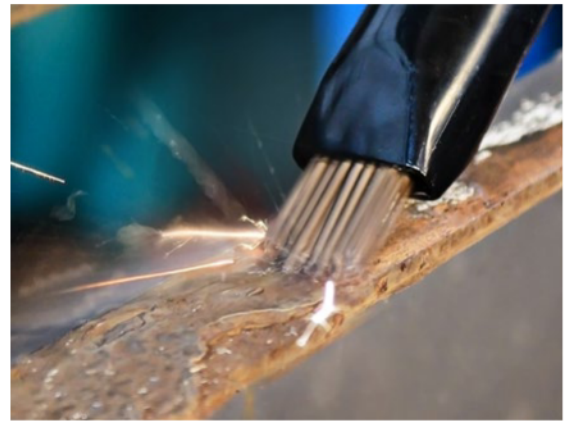

9035-5

EAN-No. 4000896132355

**296.-€\***  
net

HAZET No.	Designation		EAN-No. 4000896+	€* net
9035-050	Spare needles for needle scaler 9035-5, ∅ 3 mm	19	139385	23.30

## Air blow and suction gun, switchable

- Sucking up dirt into the collection bag as well as for blowing surfaces clean
- One-hand reversing switch
- Metal housing
- Deflector special bag insert protects the bag against damage, e. g. due to swarfs, by preventing direct impact of the accelerated swarfs
- Vacuum level: 7.5 mmHg

Incl. accessories



9043N-10

EAN-No. 4000896198382

**77.-€\***  
net



HAZET No.	Accessories		EAN-No. 4000896+	€* net
9043N-10-07/2	Dust collecting bag set	2	202607	12.-
9043N-10-08/2	Fine dust bag set	2	222827	12.-



## Wash-gun set

- Effective, powerful and solvent-free cleaning of e.g. cooling systems with graduated system cleaning nozzle
- Cleaning without the use of aggressive chemicals or solvents
- Swivel joint at the water connection, helps to avoid "hose spaghetti"
- Continuous independent regulation of water and compressed air supply
- Temperature range -10°C / +40°C

### Contents:

- Water connection variants: 13 mm (1/2") nipple for water coupling (Gardena system compatible) or 20 mm (3/4") GHT thread
- Graded system cleaning nozzles
- Jet washing nozzle



Jet washing nozzle



Graded system cleaning nozzles

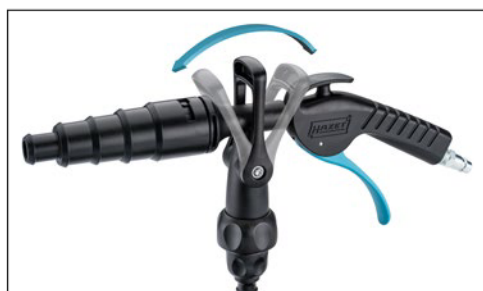

9048P-2/3  
EAN-No. 4000896234608

**65.90€\***  
net



## Soda spray gun

- Mineral spray gun for gentle, damage-free and environment-friendly cleaning and removal of paint with NaHCO<sub>3</sub> (sodium bicarbonate)
- Does not damage rubber, glass or plastic parts
- No heating / deformation of sheets during blasting
- Refillable container with 1.2 l volume
- Including 1 kg soda blast-cleaning agent



1x preset metal precision nozzle for optimum performance



3x high performance wide-jet nozzles



9045P-1  
EAN-No. 4000896209590

**109.90€\***  
net



## Car body gun

- For underbody protection and cavity sealing
- Suitable for aqueous and oily liquids
- Including metal intake pipe, nozzle and cavity tube
- Temperature range: -10°C – 80°C
- Max. working pressure: 16 bar
- Dimensions / length: 251 mm



9042P-4  
EAN-No. 4000896209613

**48.50€\***  
net

## Air blow gun, long



9040LG-3/2  
EAN-No. 4000896206339

**77.50€\***  
net

## Nozzles for long air blow gun:

### Venturi nozzle

- 100% increase in air outlet quantity thanks to Venturi effect
- For 9040-4 and 9040 LG-3/2



9040LG-3-01  
EAN-No. 4000896241514

**20.50€\***  
net

### Lateral nozzle 90°

- Nozzle enables lateral blow-out, e.g. for cleaning cooling fins and other hard-to-reach areas
- For 9040-4 and 9040 LG-3/2



9040LG-3-02  
EAN-No. 4000896241521

**20.50€\***  
net

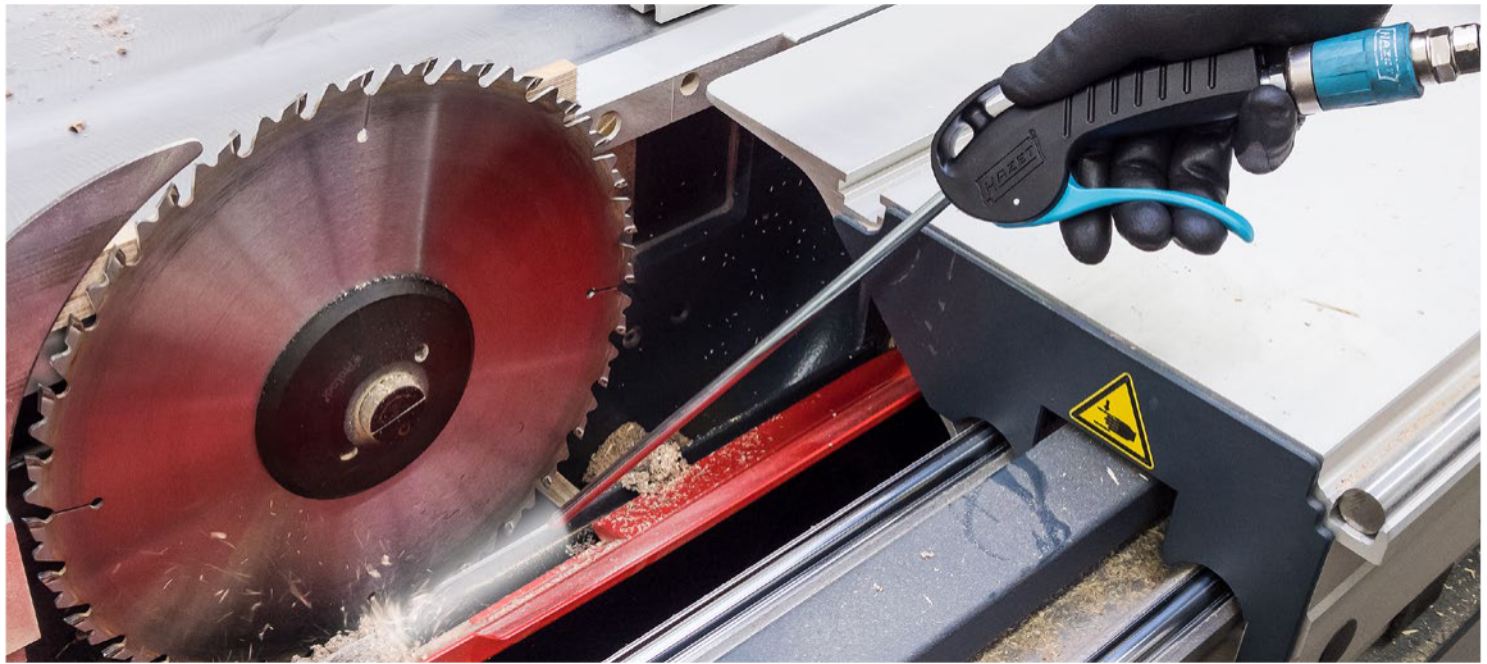

### Standard nozzle

- Curved tube:  $\varnothing$  8 mm, 100 mm
- Temperature range: -10°C to 80°C
- Max. working pressure: 16 bar
- Dimensions / length: 247 mm



9040P-1  
EAN-No. 4000896209545

**15.10€\***  
net



### Long nozzle

- Straight tube:  $\varnothing$  8 mm, 300 mm
- Temperature range: -10°C to 80°C
- Max. working pressure: 16 bar
- Dimensions / length: 420 mm

9040P-2  
EAN-No. 4000896209552

**26.90€\***  
net

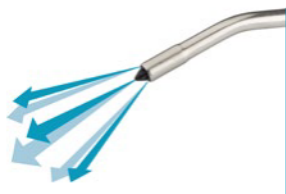

### Low noise

- Curved tube:  $\varnothing$  8 mm, 100 mm
- Non-blocking
- Temperature range: -10°C to 80°C
- Max. working pressure: 12 bar
- Dimensions / length: 255 mm



9040P-3  
EAN-No. 4000896209644

**26.90€\***  
net



### Venturi nozzle

- Curved tube:  $\varnothing$  8 mm, 100 mm
- 100% increase in air outlet quantity thanks to Venturi nozzle
- Temperature range: -10°C to 80°C
- Max. working pressure: 16 bar
- Dimensions / length: 265 mm



9040P-4  
EAN-No. 4000896209569

**26.90€\***  
net

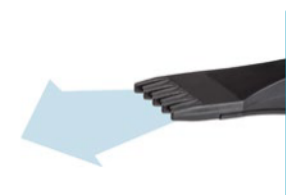

### Broad, flat nozzle

- Considerable blowing force
- Non-blocking
- Temperature range: -10°C to 80°C
- Max. working pressure: 8 bar
- Dimensions / length: 203 mm



9040P-5  
EAN-No. 4000896209576

**26.90€\***  
net



### Exchangeable nozzle

- Choice of air supply at tool head or handle
- Exchangeable nozzles:
  - Short nozzle for areas with restricted access
  - Long nozzle (112 mm) with safety nozzle tip (scratch protection)
- Max. working pressure: 10 bar

9040-4  
EAN-No. 4000896176236

**22.80€\***  
net



## HAZET HOSE OR CABLE REEL

Offers tidiness in the workshop – cable not left lying around, thus reducing the risk of accidents!

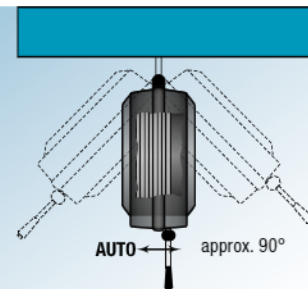
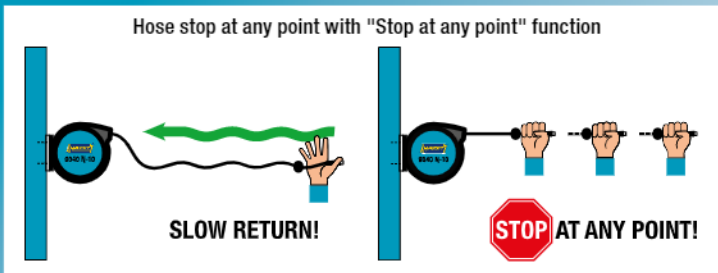

### Hose reel

- Suitable for compressed air or water
- Max. working pressure: 20 bar
- Temperature range: -40°C to 60°C
- Hose length: 15 m
- Length of connection hose: 0.9 m
- Automatic guidance winds the hose neatly
- Braked winding to prevent risk of accidents
- Dimensions: 459 x 378 x 205 mm



Inside diameter of the hose:  $\varnothing$  10 mm

- External thread: 16.41 mm 3/8"

9040N-10  
EAN-No. 4000896206445

155.90€<sup>\*</sup>  
net



Inside diameter of the hose:  $\varnothing$  13 mm

- External thread: 20.96 mm 1/2"

9040N-13  
EAN-No. 4000896214648

184.90€<sup>\*</sup>  
net



### Cable reel

- Including line circuit breaker
- Only suitable for indoor use
- 230 V AC
- Cable: H07RN-F 3 x 2.5 mm<sup>2</sup>
- Cable length: 20 m
- Connecting cable length: 1.5 m
- Automatic guidance winds the hose neatly
- Braked winding to prevent risk of accidents



9040D-2.5  
EAN-No. 4000896214631

223.-€<sup>\*</sup>  
net



### Spiral hose

- High flexible polyurethane hose
- Connecting pieces with 360° swivel joints
- Temperature range: -20°C to 60°C
- Hose length: 7.62 m
- Working pressure: 10 bar



Inside diameter of the hose:  $\varnothing$  6.35 mm

9040-7  
EAN-No. 4000896153404

43.50€<sup>\*</sup>  
net

Inside diameter of the hose:  $\varnothing$  10 mm

9040S-10  
EAN-No. 4000896212361

58.50€<sup>\*</sup>  
net



### Blind rivet gun

- Pneumatic / hydraulic
- Possible rivet sizes:
  - Aluminium rivets: 2.4–4.8 mm
  - Steel rivets: 2.4–4.8 mm
  - Stainless steel rivets: 2.4–3.2 mm
- 4 nose pieces (one pre-installed): 2.4 · 3.2 · 4 · 4.8 mm
- Length: 270 mm



9037SPC  
EAN-No. 4000896150168

165.-€<sup>\*</sup>  
net





**Grease gun**

- Filling capacity: 400 ml

9042N-1

EAN-No. 4000896176472

99.-€<sup>\*</sup>  
net



**Mini grease gun**

- Filling capacity: 80 g

2162M

EAN-No. 4000896185634

20.50€<sup>\*</sup>  
net



**High performance lubricant**

- Grease cushion: 60 ml

**Made in Germany**

9300N-60

EAN-No. 4000896203406

8.90€<sup>\*</sup>  
net



**Mini oiler**

- Filling capacity: 28 ml

9070N-1

EAN-No. 4000896206407

13.90€<sup>\*</sup>  
net



**Special pneumatic tool oil**

- Filling capacity: 100 ml

**Made in Germany**

9400-100

EAN-No. 4000896191390

7.10€<sup>\*</sup>  
net



- Filling capacity: 1,000 ml

**Made in Germany**

9400-1000

EAN-No. 4000896191406

16.90€<sup>\*</sup>  
net

**Safety coupling**

- For air connection nipple 7.3 mm
- Working range: 0 – 20 bar
- Air inlet thread (internal thread): 16.41 mm (5/8")
- Suitable for hose reel 9040N-10



9000-061

EAN-No. 4000896195299

33.90€<sup>\*</sup>  
net

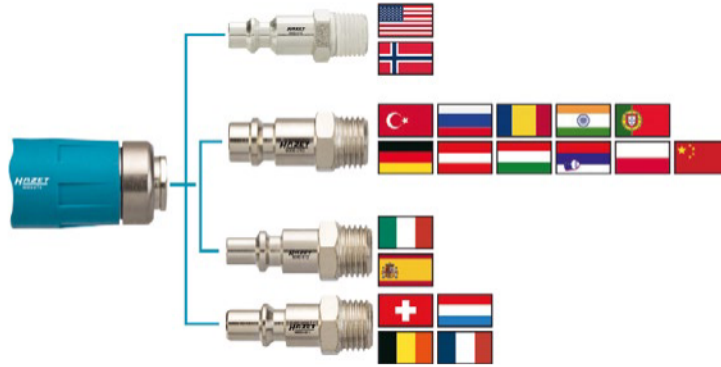

**Safety coupling**

- For air connection nipple 10 mm
- Working range: 0 – 50 bar
- Air inlet thread (internal thread): 20.95 mm (1/2")
- Suitable for hose reel 9040N-13



9000-062

EAN-No. 4000896218936

42.90€<sup>\*</sup>  
net

**Rotary joint**

- With continuous air flow rate reducer
- Air flow regulation by means of setting wheel
- 360° rotation joint in 2 axes
- Maximum pressure: 16 bar
- Air connection inlet: internal thread 12.91 mm 1/4"
- Air connection outlet: external thread: 12.91 mm 1/4"

9000-040

EAN-No. 4000896195350

41.90€<sup>\*</sup>  
net



**Rotary joint**

- 360° rotation joint in 2 axes
- Maximum pressure: 16 bar
- Air connection inlet: internal thread 12.91 mm 1/4"
- Air connection outlet: external thread 12.91 mm 1/4"

9000-041

EAN-No. 4000896204441

16.90€<sup>\*</sup>  
net



**Compressed air reducer**

- Reduction of working pressure to protect high-quality pneumatic equipment
- Max. inlet pressure: 10 bar
- Outlet pressure 6,3 bar
- Air connection inlet: internal thread 12.91 mm 1/4"
- Air connection outlet: external thread: 12.91 mm 1/4"

9000-080

EAN-No. 4000896214709

51.-€<sup>\*</sup>  
net





## HAZET CORDLESS TOOLS SUITABLE FOR ALL DEVICES!



High efficiency thanks to brushless motor

### Brushless DC motor (BLDC)<sup>1</sup>

- ▶ Longer service life, less wear, no need to change the carbon brushes
- ▶ High efficiency and hence lower battery consumption
- ▶ More compact motor enables smaller dimensions

<sup>1</sup> Applies to all HAZET cordless tools except 9212SPC-1

Li-ion rechargeable battery 2.0 Ah, charging time: 35 min  
9212-02  
EAN-No. 4000896213788

**74.50€\***  
net

Li-ion rechargeable battery 5.0 Ah, charging time: 80 min  
9212-05  
EAN-No. 4000896210367

**118.20€\***  
net

Quick charger for rechargeable batteries  
9212-03  
EAN-No. 4000896204823

**81.-€\***  
net

### Cordless drill set, 18 V

- Max. tightening torque: 60 Nm
- Brushless DC motor (BLDC)
- Selectable torque settings 15 + 1 drilling
- Vibration acceleration screwing: 0.8 m/s<sup>2</sup>
- Vibration acceleration drilling 2.3 m/s<sup>2</sup>
- Robust machine housing
- Suitable for continuous operation
- **Set of 3 pieces in textile bag:**
  - 1 Cordless drill
  - 1 Quick charger (40 minutes)
  - 1 Li-ion rechargeable battery 18 V, 2 Ah



Tool-free metal quick-clamping drill chuck 1-13 mm

9230-2  
EAN-No. 4000896218370

**335.-€\***  
net



HAZET No.	Designation	EAN-No. 4000896 +	€* net
9230-010	Basic unit (without rechargeable battery, without charger)	218974	185.-
9230-2/4	4-piece set: 1 cordless drilling machine, 1 quick charger, 2 Li-ion rechargeable batteries 18 V, 2.0 Ah	218967	390.-

### 1/2" cordless impact wrench set, 18 V Maximum loosening torque: 260 Nm

- Illumination of the work area before the output begins to move
- Extremely handy tool
- Light weight design
- Recommended torque: 200 Nm
- **Set of 3 pieces in textile bag:**
  - 1 Cordless impact wrench
  - 1 Quick charger (40 minutes)
  - 1 Li-ion rechargeable battery 18 V, 2 Ah



Top seller!

9212SPC-1  
EAN-No. 4000896212439

**211.80€\***  
net



HAZET No.	Designation	EAN-No. 4000896 +	€* net
9212SPC-010	Basic unit (without rechargeable battery, without charger)	214273	139.50
9212SPC-1/4	4-piece set: 1 basic unit, 1 charger, 2 Li-ion rechargeable batteries 2.0 Ah	214259	286.20

### 1/2" mini cordless impact wrench set, 18 V Maximum loosening torque: 270 Nm

125 1/2 3

- Recommended torque: 220 Nm
- Brushless DC motor (BLDC)
- Three selectable power levels for torque pull:
  - Level 1 100 Nm at 0 – 700 rpm (0 – 1200 impacts/min)
  - Level 2 190 Nm at 0 – 1600 rpm (0 – 2000 impacts/min)
  - Level 3 220 Nm at 0 – 2500 rpm (0 – 3200 impacts/min)

- Set of 3 pieces in textile bag:
  - 1 Cordless impact wrench
  - 1 Quick charger (40 minutes)
  - 1 Li-ion rechargeable battery 18 V, 2 Ah

1/2"



9212M-1  
EAN-No. 4000896212446

309.–€\*  
net



HAZET No.	Designation	EAN-No. 4000896+	€* net
9212M-010	Basic unit (without rechargeable battery, without charger)	214280	203.30
9212M-1/4	4-piece set: 1 basic unit, 1 charger, 2 Li-ion rechargeable batteries 2.0 Ah	214266	372.–

### 1/2" cordless impact wrench set, 18 V Maximum loosening torque: 700 Nm

125 1/2 3

- Recommended torque: 500 Nm
- Brushless DC motor (BLDC)
- Three selectable power levels for torque pull:
  - Level 1 80 Nm at 0 – 600 rpm (0 – 1200 impacts/min)
  - Level 2 300 Nm at 0 – 1400 rpm (0 – 2500 impacts/min)
  - Level 3 500 Nm at 0 – 2000 rpm (0 – 3400 impacts/min)

- Set of 3 pieces in L-Boxx:
  - 1 Cordless impact wrench
  - 1 Quick charger (40 minutes)
  - 1 Li-ion rechargeable battery 18 V, 5 Ah

1/2"



9212-3LB/3  
EAN-No. 4000896244164

599.–€\*  
net



HAZET No.	Designation	EAN-No. 4000896+	€* net
9212-010	Basic unit (without rechargeable battery, without charger)	221790	384.–
9212-3LB/4	4-piece set: cordless impact wrench 18 V, 1 charger, 2 Li-ion rechargeable batteries 5.0 Ah, in L-Boxx	244171	699.–

### 1/2" cordless impact wrench set, 18 V Maximum loosening torque: 1400 Nm

125 1/2 3

- Max. tightening torque: 1000 Nm
- Brushless DC motor (BLDC)
- Three selectable power levels for torque pull:
  - Level 1 180 Nm at 0 – 400 rpm (0 – 800 impacts/min)
  - Level 2 400 Nm at 0 – 800 rpm (0 – 1600 impacts/min)
  - Level 3 1000 Nm at 0 – 1800 rpm (0 – 2200 impacts/min)

- Set of 3 pieces in L-Boxx:
  - 1 Cordless impact wrench
  - 1 Quick charger (40 minutes)
  - 1 Li-ion rechargeable battery 18 V, 5 Ah

1/2"



9212-1000LB/3  
EAN-No. 4000896249848

699.–€\*  
net



HAZET No.	Designation	EAN-No. 4000896+	€* net
9212-1000	Basic unit (without rechargeable battery, without charger)	222711	499.–
9212-1000LB/4	4-piece set: 1 basic unit, 1 charger, 2 Li-ion rechargeable batteries 5.0 Ah in L-Boxx	249909	799.–

### 3/4" cordless impact wrench set, 18 V Maximum loosening torque: 1400 Nm

20 3/4 3

- Max. tightening torque: 1000 Nm
- Brushless DC motor (BLDC)
- Three selectable power levels for torque pull:
  - Level 1 180 Nm at 0 – 400 rpm (0 – 800 impacts/min)
  - Level 2 400 Nm at 0 – 800 rpm (0 – 1600 impacts/min)
  - Level 3 1000 Nm at 0 – 1800 rpm (0 – 2200 impacts/min)

- Set of 3 pieces in L-Boxx:
  - 1 Cordless impact wrench
  - 1 Quick charger (40 minutes)
  - 1 Li-ion rechargeable battery 18 V, 5 Ah

3/4"



9213-1000LB/3  
EAN-No. 4000896249886

699.–€\*  
net



HAZET No.	Designation	EAN-No. 4000896+	€* net
9213-1000	Basic unit (without rechargeable battery, without charger)	222698	507.–
9213-1000LB/4	4-piece set: 1 basic unit, 1 charger, 2 Li-ion rechargeable batteries 5.0 Ah in L-Boxx	249862	799.–





## Cordless right-angle grinder, 18 V

- Revolutions per minute: 8000
- Brushless DC motor
- Including 1 protective cover each
  - for cut-off wheels
  - for rough grinding wheels

### 3-piece set in case:

- 1 cordless right-angle grinder
- 1 quick charger
- 1 Li-ion rechargeable battery 18 V, 5 Ah



Mesh fabric protects motor from dirt

3

HAZET No.	Designation	EAN-No. 4000896+	€ <sup>+</sup> net
9233-010	Basic unit (without rechargeable battery, without charger)	218943	329.–
9233-7/4	4-piece set: 1 cordless right-angle grinder, 1 quick charger, 2 Li-ion rechargeable batteries 18 V, 5.0 Ah	218950	560.–



9233-7  
EAN-No. 4000896218325

455.– €<sup>+</sup> net

## Cordless reciprocating saw

- Support frame, adjustable in height, suitable for double-walled sheet steel
- Brushless DC motor
- Strokes/min.: 9500
- Wood cutting capacity: 200 mm
- Metal cutting capacity: 20 mm
- Tool-free saw blade quick-change system
- Quick adjustment of bars without tools

### 3-piece set in HAZET L-Boxx 136:

- 1 cordless reciprocating saw
- 1 quick charger
- 1 Li-ion rechargeable battery 18 V, 5 Ah



3



HAZET No.	Designation	EAN-No. 4000896+	€ <sup>+</sup> net
9234-010	Cordless reciprocating saw basic unit (without rechargeable battery, charger, L-Boxx and insert)	234707	270.–
9234-1/4	4-piece set: 1 cordless reciprocating saw, 1 quick charger, 2 Li-ion rechargeable batteries 18 V, 5.0 Ah in L-Boxx	234721	563.–



9234-1  
EAN-No. 4000896234714

446.– €<sup>+</sup> net



HAZET No.	Spare parts	Length of serration mm	EAN-No. 4000896+	€ <sup>+</sup> net
9234M-150/5	5 flexible reciprocating saw blades for steel and nonferrous metal from 2 – 8 mm	130	239382	14.90
9234P-150/5	5 flexible reciprocating saw blades for wood with nails and faster sawing progress in metal 2 – 10 mm	130	239405	17.90
9234P-225/5	5 flexible reciprocating saw blades for wood with nails and faster sawing progress in metal 2 – 10 mm	205	239412	22.90
9234X-150/5	5 flexible reciprocating saw blades for steel and stainless steel (Inox) from 1.5 – 4 mm	130	239597	14.90
9234W-225/5	5 reciprocating saw blades for all wood types, plastics as well as plasterboard 6 – 100 mm	205	239429	17.90
9034P-R/5	5 reciprocating sabre saw blades	132	218318	27.20



## HAZET THERMAL CAMERAS – FOR OPTIMUM VIEWING CLARITY!

- ▶ Building diagnostics, electrical installation, sanitary, air-conditioning and heating technology as well as inspection of engine compartment, brake system, cooling and heating system
- ▶ Automatic hot, cold and central point measurement
- ▶ Image sensor: Vanadium oxide uncooled focal plane arrays (FPA)
- ▶ Refresh rate: 25 Hz
- ▶ Thermal sensitivity (Noise Equivalent Temperature Difference, NETD): <math>< 40 \text{ mK (0.04}^\circ\text{C)}</math>
- ▶ Measuring accuracy maximum ( $\pm 2^\circ\text{C} \mid \pm 2\%$ ): ambient temperatures  $15^\circ\text{C} - 35^\circ\text{C}$  / object temperatures above  $0^\circ\text{C}$
- ▶ IP protection rating: 54
- ▶ Battery: lithium-ion rechargeable battery



- Screen size: 2.4" LCD screen
- Display resolution is 320 x 240 pixels
- Thermal (or IR) resolution: 160 x 120 pixels
- Field of view:  $37.2^\circ \times 50^\circ$
- Temperature measuring range:  $-20^\circ\text{C}$  to  $550^\circ\text{C}$  ( $-4^\circ\text{F}$  to  $1,022^\circ\text{F}$ )
- Battery life: up to 8 hours
- Dimensions (H x W x D): 196 x 117 x 59 mm
- Weight: 0.35 kg



1992-1  
EAN-No. 4000896244270

**499.-€\***  
net



- Screen size: 3.5" LCD touchscreen
- Display resolution is 640 x 480 pixels
- Thermal (or IR) resolution: 256 x 192 pixels
- Field of view:  $50^\circ \times 37.2^\circ$
- Temperature measuring range:  $-20^\circ\text{C}$  –  $400^\circ\text{C}$  ( $-4^\circ\text{F}$  to  $752^\circ\text{F}$ )
- Battery life: up to 4 hours
- Dimensions (H x W x D): 138.5 x 85.2 x 23.6 mm
- Weight: 0.22 kg

**NEW!**

Detailed information



1992-2  
EAN-No. 4000896249435

**799.-€\***  
net

More detail through visual camera:  
**3,264 x 2,448 pixels (8MP)**

Digital zoom 4 x

Touchscreen

Record videos

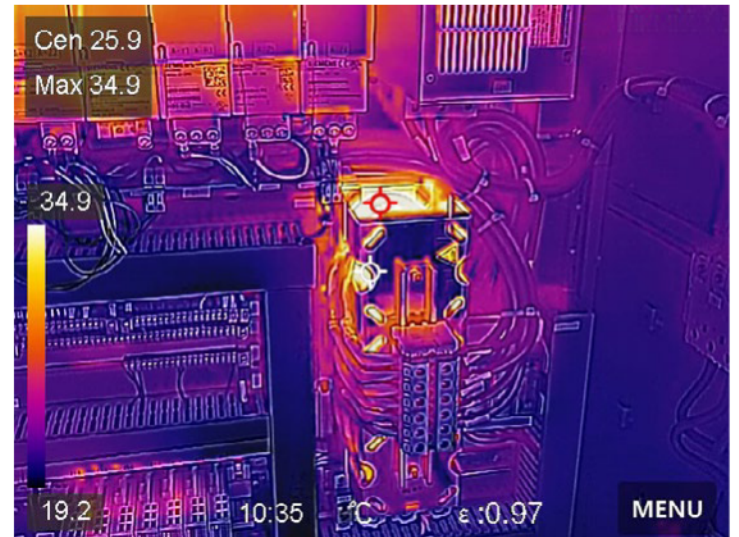



## IMPROVED ACCURACY OF DETAIL DUE TO HD CAMERA!

- ▶ Bright and sharper image
- ▶ Better details
- ▶ Clearer image



### Comparison of HD to other resolutions

HD 1,920 x 1,080 pixels (4812-23AF)



1,024 x 768 pixels (4812-21AF)



640 x 480 pixels (4812N-2AF)

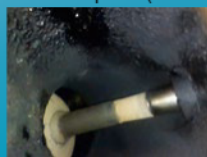

## HD borescope set with front and side camera, Ø 4.9 mm

- Light boost and integrated reflection reduction
- Luminous source: 5 dimming LEDs for optimum lighting
- Optional recording in different time loops
- Zoom: 1.5 x and 2 x
- Image format (jpg): 1,920 x 1,080 pixels
- Video format (MP4): 1,920 x 1,080 pixels
- Mirroring of the camera image
- Negative display of the camera image
- Data transfer: USB-C
- Video output: micro HDMI
- Operating temperature: 10°C up to 50 °C
- Operating humidity of up to 90% (non-condensing)
- IP protection rating (basic unit): IP54
- USB interface can be used as a power source when no batteries are inserted
- Compatible with HAZET HD probes 4812-11FS and 4812-23AF
- Power source: 4 x AA battery
- Weight: 370 grams without batteries
- Dimensions (L x W x H): 276.25 x 123 x 53.95 mm

### 5-piece set in plastic case:

- Basic unit 4812-11G
- HD probe 4812-11FS
- SD card with 32 GB storage capacity
- Micro HDMI cable (A to D) 1.8 m
- USB-C cable (A to C) 1 m



4812-11/5FS

EAN-No. 4000896249572

749.-€<sup>\*</sup><sub>net</sub>

Detailed information



5

NEW!



HD probe with front and side camera!

## No compatibility between previous system and new HD system!

Previous system



New HD system

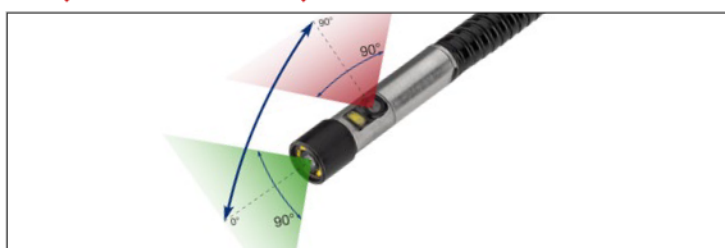

## HD probe Ø 4.9 mm, front and side camera

- Compatible with basic unit 4812-11G and 4812-23G
- Semi-flexible probe enables guidance through cavities
- Front and side camera switchable (0° and 90°)
- Dimmable 5 x LED light source for front camera
- Dimmable LED light source for side camera
- Digital interface to basic unit: USB-C
- Viewing angle (FOV): 90°
- Depth of focus (DOF): 10 – 100 mm
- Resolution: HD 1280(H) x 720(V) pixels
- Compression format: H264
- Operating temperature: -10°C up to 60 °C
- Probe protection rating: IP67
- Weight: 137 g

4812-11FS

EAN-No. 4000896249565

599.-€<sup>\*</sup><sub>net</sub>

NEW!





## HD touch screen borescope set with swivelling probe 180°, Ø 3.9 mm

- Touch screen colour display with Li-Ion battery and magnetic holder
- 127 mm (5 inch) touch display, readable in sunlight
- Display resolution: 800 x 480 pixels
- 10-level brightness setting (5 + 5 boost)
- Zoom: 3 x
- Recording in 3 different time loops
- Image format (jpg): 1,920 x 1,080 pixels
- Video format (MP4): 1920 x 1080 pixels
- Negative display of the camera image
- Data transfer: USB-C
- HDMI port for video output
- Video output: micro HDMI
- Rechargeable battery: li-ion battery
- Charging time 3.5 h
- Operating time when fully charged: 4 hours
- Operating temperature: 10°C up to 50 °C
- Operating humidity of up to 90 % (non-condensing)
- IP protection rating (basic unit): IP54
- Built-in microphone
- Compatible with HAZET HD probes 4812-23AF and 4812-11FS
- Weight: 705 g
- Dimensions: 161.9 x 127.9 x 46 mm

### 5-piece set in HAZET L-Boxx 136:

- Basic unit 4812-23G
- HD probe 4812-23AF
- SD card 64 GB incl. adapter
- Micro HDMI cable (D)
- USB-C cable



**HD swivelling probe with front camera!**

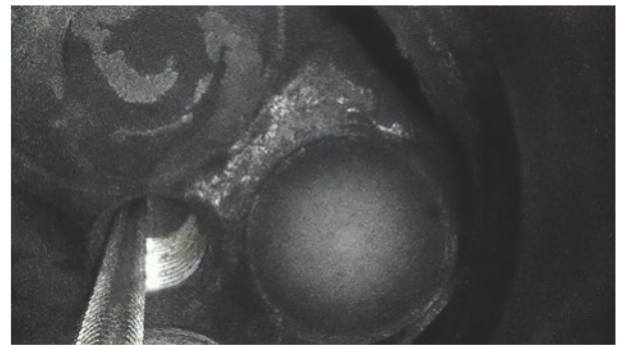

4812-23/5AF  
EAN-No. 4000896249824

**1,999.-€\***  
net



## HD swivelling probe 180° Ø 3.9 mm, front camera

- Compatible with basic unit 4812-23G and 4812-11G
- Incl. control unit to operate articulation, video recording, brightness control
- Bending radius only approx. 35 mm (-30% compared to conventional designs)
- High mobility due to bilateral articulation
- Full swivel up to 180° on both sides enables e.g. a real reverse view onto valves in the cylinder head
- Front camera
- Dimmable 2 x LED light source
- Digital interface to basic unit: USB-C
- Viewing angle (FOV): 90°
- Depth of focus (DOV): 10 – 100 mm
- Resolution: HD 1280(H) x 720(V) pixels
- Compression format: H264
- Operating temperature: -10°C up to 60 °C
- Probe protection rating: IP67
- Weight: 307 g

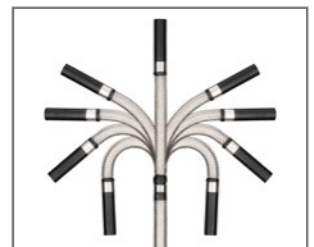

4812-23AF

EAN-No. 4000896249602

**1,500.-€\***  
net





No more tangled cables thanks to wireless charging



Optimised self-positioning on the pad



Additional USB port for charging more devices

## Wireless charging

### LED light set

- Efficient and comfortable charging function due to optimised self-positioning of the lamp on the pad
- Wirelessly mobile and versatile, especially in extremely tight spaces

#### Contents:

- 1979W-82 LED pocket light
- 1979W-92 LED slim light
- 1979WP-2 Charging pad for 2 lights
- Incl. 100 cm USB-C cable and 2 A / 5 V power supply unit

1979W1/3

EAN-No. 4000896241408

**148,90€\***  
net

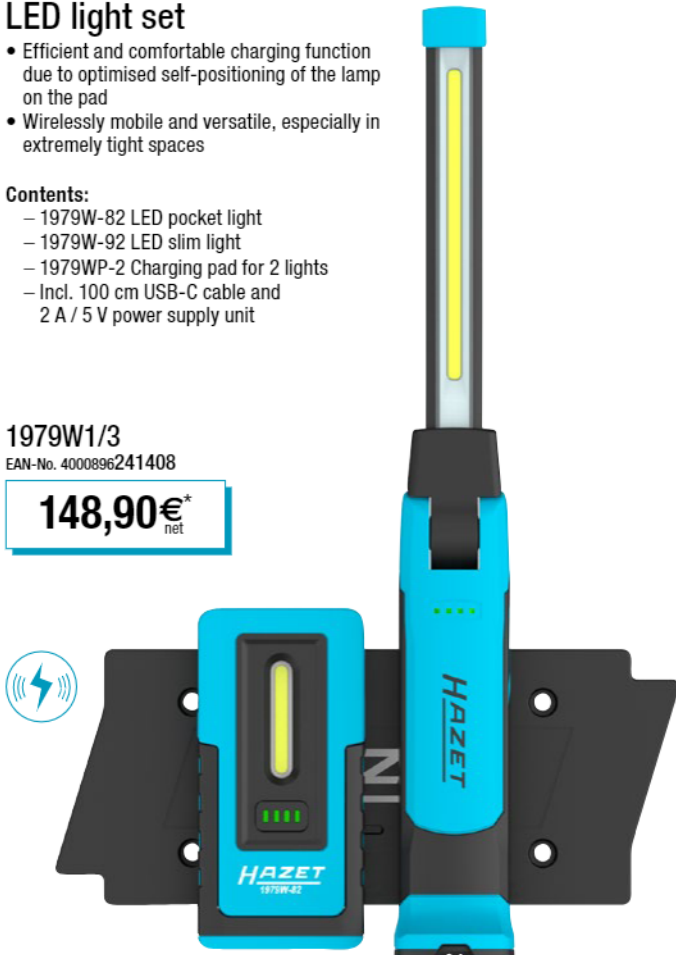

3



### LED pen light set

#### Contents:

- 2 x 1979 W-11 pen light
- 1979WP-2 Charging pad for 2 lights
- Incl. 100 cm USB-C cable and 2 A / 5 V power supply unit

## Wireless charging



3

1979W-11/3

EAN-No. 4000896235247

**87,90€\***  
net



### LED inspection lamp set

#### Contents:

- 1979W-11 Pen light
- 1979W-82 Pocket light
- 1979WP-2 Charging pad for 2 lights
- Incl. 100 cm USB-C cable and 2 A / 5 V power supply unit

## Wireless charging

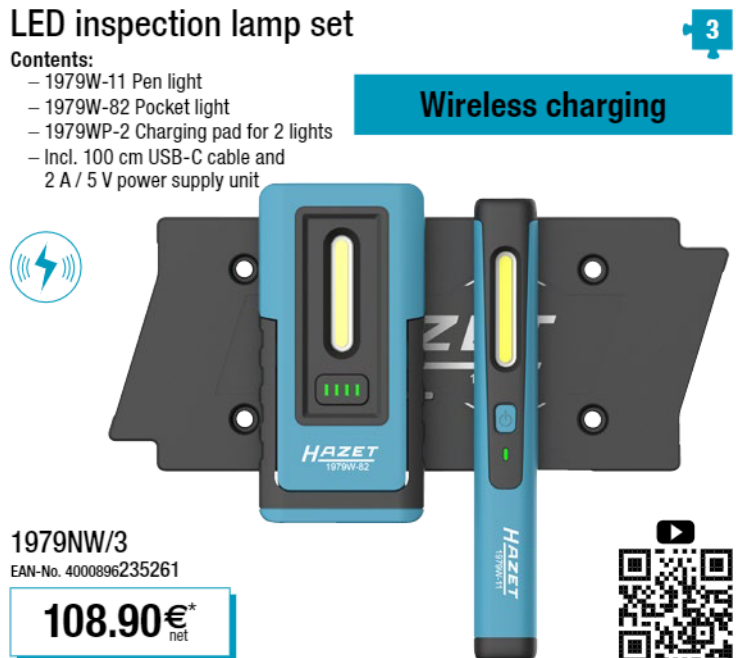

3

1979NW/3

EAN-No. 4000896235261

**108,90€\***  
net





**Wireless charging**

• Cable-free charging of LED lights



Top light:  
• 100 lm  
• 5 h

Main light:  
• 30 – 300 lm  
• 2 h

LED pocket light  
1979W-82

EAN-No. 4000896227228

60.90€<sup>\*</sup>  
net



Top light:  
• 120 lm  
• 4 h

Main light:  
• 20 – 200 lm  
• 2.5 h

LED pen light  
1979W-11

EAN-No. 4000896235230

28.90€<sup>\*</sup>  
net



Top light:  
• 300 lm  
• 4.5 h

Main light:  
• 60 – 600 lm  
• 3 h

LED solid Light  
1979W-85

EAN-No. 4000896241484

64.90€<sup>\*</sup>  
net

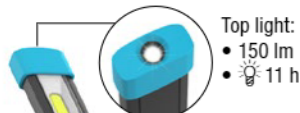

Top light:  
• 150 lm  
• 11 h

Main light:  
• 110 – 1100 lm  
• 3 h

LED slim light  
1979W-92

EAN-No. 4000896241422

73.90€<sup>\*</sup>  
net



Charging pad for one light

1979WP-1

EAN-No. 4000896227952

36.90€<sup>\*</sup>  
net



Charging pad for two lights

1979WP-2

EAN-No. 4000896227945

49.90€<sup>\*</sup>  
net



Battery can be charged via a standard USB adapter 5 V maximum 1 A

**With charging cable**

• Delivery incl. 100 cm USB-C charging cable (without USB power supply unit)



Top light:  
• 100 lm  
• 5 h

Main light:  
• 30 – 300 lm  
• 2 h

LED pocket light  
1979N-82

EAN-No. 4000896227211

45.90€<sup>\*</sup>  
net

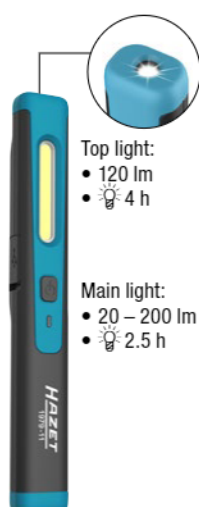

Top light:  
• 120 lm  
• 4 h

Main light:  
• 20 – 200 lm  
• 2.5 h

LED pen light  
1979N-11

EAN-No. 4000896235254

21.90€<sup>\*</sup>  
net



Top light:  
• 300 lm  
• 4.5 h

Main light:  
• 60 – 600 lm  
• 3 h

LED solid Light  
1979N-85

EAN-No. 4000896241491

59.90€<sup>\*</sup>  
net



Top light:  
• 150 lm  
• 11 h

Main light:  
• 110 – 1100 lm  
• 3 h

LED slim light  
1979N-92

EAN-No. 4000896241415

81.90€<sup>\*</sup>  
net

**With batteries**

• Incl. batteries: 1.5 V micro / AAA / (L)R03



• 130 lm  
• 4 h

LED pen light

1979N-71

EAN-No. 4000896208470

19.50€<sup>\*</sup>  
net



• 200 lm  
• 4.5 h

LED torch light  
1979N-72

EAN-No. 4000896208487

39.90€<sup>\*</sup>  
net





**Spraying with cleaning agents and disinfectants**

**Produces dense, durable foam**

**Savings due to the use of large containers**

### Pressure sprayer

- Seals and materials resistant to most acids and solvents as well as to chemicals that are used most frequently in industry, automotive technology and professional cleaning
- Viton® gaskets
- Filling capacity: 1 l
- Weight: 0.46 kg

### Pressure foam sprayer

- Three nozzles (in scope of delivery) for generating wet and dry foams as well as for implementing different reaction times
- Viton® gaskets
- For use of chemicals with surface-active properties (surfactants)
- Filling capacity 0.75 l
- Weight: 0.47 kg

### Spray bottle, refillable

- Use with multi-purpose spray, such as e.g. penetrating oil, rust remover, as well as rim and brake cleaner
- Viton® gaskets
- Including 155 mm long jet nozzle and short spray nozzle
- Filling capacity: 0.23 l
- Weight: 0.4 kg



199N-1  
EAN-No. 4000896189007  
**29.70€\***  
net



199-3  
EAN-No. 4000896207237  
**34.90€\***  
net



199-4  
EAN-No. 4000896198429  
**55.-€\***  
net

### Working gloves



1987N-3  
EAN-No. 4000896222650  
**8.70€\***  
net



1987N-4  
EAN-No. 4000896203840  
**4.80€\***  
net



• In L, XL or XXL  
Each  
**26.70€\***  
net



1987-5L  
EAN-No. 4000896181735  
1987-5XL  
EAN-No. 4000896181759  
1987-5XXL  
EAN-No. 4000896181766

1987-6  
EAN-No. 4000896222643  
**11.10€\***  
net



### Pneumatic chair

- 5 castors (approx. 76 mm Ø)
- Loading capacity: up to 125 kg
- Weight: 5.8 kg
- Adjustable in height from 396 to 526 mm



**With 5 sturdy castors!**

195-4  
EAN-No. 4000896148707  
**99.-€\***  
net



### Dashboard protection set

- With handle



4852/4  
EAN-No. 4000896210114

**52.60€\***  
net

- Straight: 270 x 200 mm, 450 x 300 mm
- Angled: 270 x 200 mm, 450 x 300 mm



### Magnetic cup

- Ø 150 mm



197-3  
EAN-No. 4000896158584

**9.95€\***  
net



### Magnetic holder

- Loading capacity: 10 kg
- Height: 400 mm

9070-10  
EAN-No. 4000896158157

**45.90€\***  
net

### Kneeling mat

- Dimensions: 450 x 210 x 30 mm



195-1  
EAN-No. 4000896121069

**19.90€\***  
net

### Mechanic's mat

- Dimensions: 975 x 385 x 30 mm



195-5  
EAN-No. 4000896153718

**39.90€\***  
net

### Multifunctional drain pans

- Filling capacity: 6 l



197N-1  
EAN-No. 4000896198924

**11.40€\***  
net

- Filling capacity: 16 l



197-2  
EAN-No. 4000896146802

**39.-€\***  
net

- Filling capacity: 50 l



Made in Germany  
197-50  
EAN-No. 4000896210008

**51.20€\***  
net

### Telescopic inspection mirror set

- Telescopic rod, double hinge with tension spring
- Replaceable mirror (clear mirror glass) with 4 mm stainless steel threaded bar
- 4-piece set:
  - Telescopic rod, extension length: 300–740 mm
  - Round mirror: Ø 30 mm
  - Round mirror: Ø 50 mm
  - Rectangular mirror: 65 x 43 mm

1977-2/4  
EAN-No. 4000896150144

**52,50€\***  
net



**Mirror will not tarnish as polished "metal mirrors" do**



Premium quality products for crafts and trades!

Control cabinet key

- Operation of closures on e.g. switch cabinets, heating valves, heating vents, window and door handles
- Inside square: s 5 · 7 · 8 mm
- Inside triangle: s 9 · 10 mm
- Inside hexagon: 6.3 mm (1/4")
- Inside hexagon (e.g. grub screw): 3 mm
- Stepped key (square): 6 to 10 mm
- Including chain, connector and reversible bit: ⚙ 1 x 7 mm / ⚙ PH2



Made in Germany  
4617-1  
EAN-No. 4000896246366

13.90€<sup>\*</sup><sub>net</sub>

Roofing hammer

- Hammering in and extracting nails with only one tool
- Handle design: tubular steel handle
- Hammer head weight: 600 g



Made in Germany  
2138-600  
EAN-No. 4000896246311

39.50€<sup>\*</sup><sub>net</sub>

Construction bucket, 20 l

- With litre measuring scale (inside): 2 – 20 l
- Diameter: internal 335 mm, edge 365 mm



Made in Germany  
197-6  
EAN-No. 4000896246304

4.20€<sup>\*</sup><sub>net</sub>

Made from recycled materials!

Folding rule, 2 m

- Internal hinges for continuous scaling
- Carefully selected beech wood ensures special hardness and strength
- Highly abrasion-resistant, dirt-repellent and moisture-proof protective coating
- EC accuracy class III
- Scale: mm/cm 2-piece, printed on both sides
- Length: 2 m

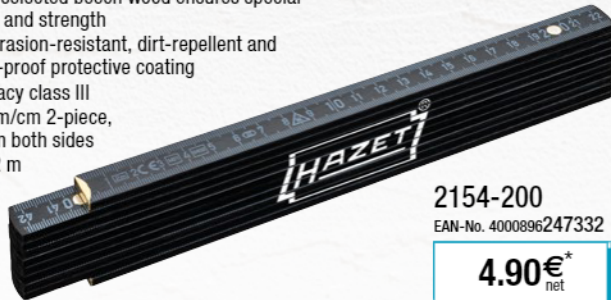

2154-200  
EAN-No. 4000896247332

4.90€<sup>\*</sup><sub>net</sub>

Plaster cup set

- Contents: 5 plaster cups
- Diameter: 125 mm
- Height: 95 mm



197-73/5  
EAN-No. 4000896247851

10.70€<sup>\*</sup><sub>net</sub>

5

Spirit levels, 40 cm / 80 cm

- With borehole for horizontal and vertical attachment or transfer of markings
- Anodised spirit level with high measuring accuracy from 1 mm/m (0.057°)
- Better readability in low light thanks to a fluorescent liquid in the block level
- High measuring accuracy in horizontal and vertical positions
- Shatterproof acrylic glass block levels
- Level installation is unaffected by temperature, allowing for measurements from -20°C to +50°C
- Antistatic level liquid
- Extremely strong aluminium profile with 590 g/m profile weight
- Acrylic glass block level with 30-year guarantee against leaking

Length: 40 cm  
2154-40  
EAN-No. 4000896246694

19.40€<sup>\*</sup><sub>net</sub>

Length: 80 cm  
2154-80  
EAN-No. 4000896246700

24.-€<sup>\*</sup><sub>net</sub>



Painter's spatula

- Flexible, milled blade
- Blade width: 60 mm
- Lacquered, flat handle with hanging hole



Made in Germany  
824-6  
EAN-No. 4000896247608

3.20€<sup>\*</sup><sub>net</sub>



### Tool set in L-Boxx



83



190L-136/83  
EAN-No. 4000896243303

Incl. SmartCase 2200SC-1

299.-€<sup>\*</sup><sub>net</sub>

### Pozidriv screwdriver set

6

- Hanging hole in handle
- Non-slip HAZET 3-component handle – allows high power transmission
- Surface: blade matt chrome-plated, tip burnished
- Contents:
  - 0.5 x 3 · 0.8 x 4 · 1 x 5.5 · 1.2 x 6.5 mm
  - PZ 1 · PZ 2



810/6PZ  
EAN-No. 4000896217984

19.90€<sup>\*</sup><sub>net</sub>

### Beam puller

- Drop forged, tempered hooks
- Tensioning, pulling, pressing of timbers
- Beam puller
- Ergonomic design – with reversible ratchet
- Span: 115 mm
- Overall width: 440 mm
- Ratchet length: 275 mm
- 2 puller hooks

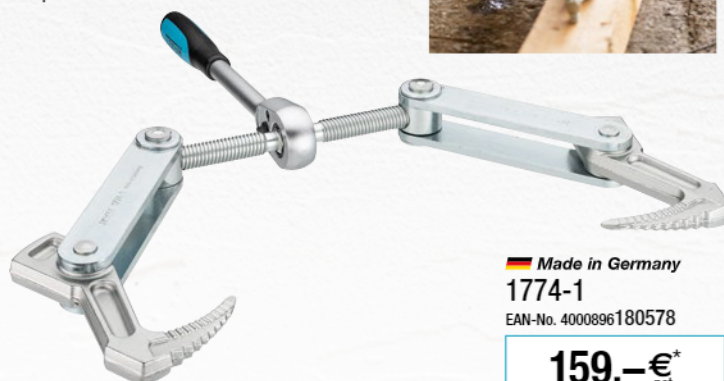
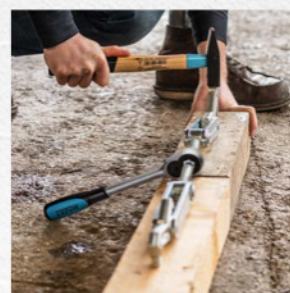

Made in Germany  
1774-1  
EAN-No. 4000896180578

159.-€<sup>\*</sup><sub>net</sub>

### Car body specialty tools

#### Extractor hook

- For the removal of e.g. trim panels, covers, plugs, fan nozzles, instrument panels, speedometer, instrument clusters inside the vehicle as well as on the car body
- High stability and flexibility despite small blade diameter x 2 mm
- 2-component T-handle

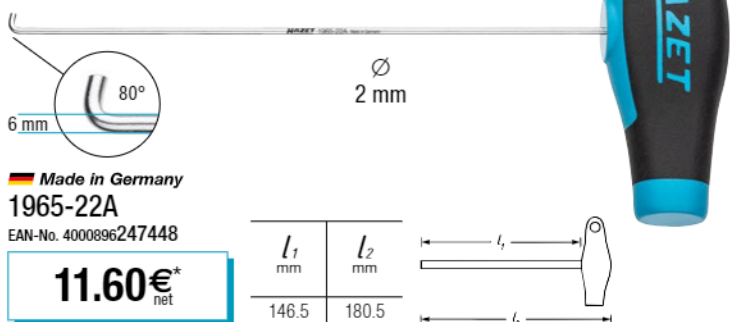

Made in Germany  
1965-22A  
EAN-No. 4000896247448

11.60€<sup>\*</sup><sub>net</sub>

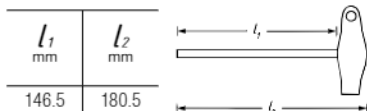

#### Universal hook/wedge set

- Plastic wedge suitable for loosening components, e.g. door clips as well as for lifting and alignment work
- Universal hook for surface-friendly loosening of e.g. window rubber, door seals, carpets, interior trim
- For universal use
- Plastic wedge: length: 214 mm, width: 26.5 mm
- Universal hook: length: 180 mm



1965/2  
EAN-No. 4000896223008

17.-€<sup>\*</sup><sub>net</sub>



## 1/2" crankshaft socket

- Operation via impact adapter e.g. HAZET 1003 S-1 or sockets  $\leq 24$  mm enables high force transmission thanks to optimum  $20 \text{ mm} = 3/4"$  drive
- Operation of the crankshaft bolt connection on DACIA, FORD, INFINITI, SUZUKI, MERCEDES-BENZ, NISSAN, OPEL, RENAULT, Volvo
- Hexagon on the socket enables adaptation to  $20 \text{ mm} = 3/4"$  drive
- Short design
- With borehole for locking pin or safety spring and groove for O-ring
- Surface: phosphatised, oiled

s  
18 mm



Made in Germany  
900SZ6-18  
EAN-No. 4000896246267

10.60€<sup>\*</sup>  
net

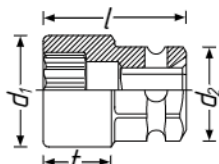

$d_1$ mm	$d_2$ mm	$l$ mm	$t$ mm
30	27	38	11



Detailed information



Higher force transmission easily possible with additionally available HAZET adapter 1003S-1 with  $3/4"$  drive or socket  $\leq 24$  mm



900SZ6-18



1003S-1

20 3/4"



## 1/4" Turbo charger special profile socket

- Operation of turbocharger intake manifold (not possible without special tool)
- Special profile engages with a positive fit in the screw connection and guarantees optimal force distribution: MERCEDES-BENZ, NISSAN, OPEL, RENAULT
- Surface: phosphatised
- For manual operation



6.3 1/4"

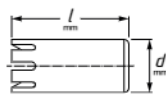

$d$ mm	$l$ mm
12	26

Detailed information



Made in Germany  
2751-1  
EAN-No. 4000896246250

7.50€<sup>\*</sup>  
net

## High-pressure pump hub puller VAG

- Remove wheel hubs with no damage when dismantling the high-pressure pump
- Especially suited to the very limited space at the installation space of the pump on the engine as well as the special shape of the wheel hub
- For 1.4 l · 1.6 l · 2.0 l TDI/common rail engines from VW, AUDI, SEAT, ŠKODA
- Hexagon for counterholding the puller:  $s 24$  mm
- Spindle thread: TR 20 x 2
- Surface: aluminium puller, spindle burnished

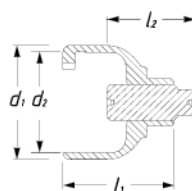

$d_1$ mm	$d_2$ mm	$l_1$ mm	$l_2$ mm
64.5	57	63	50

Detailed information



Made in Germany  
2517-1  
EAN-No. 4000896246786

43.50€<sup>\*</sup>  
net



s  
24 mm

s  
13 mm

## 1/4" TORX® screwdriver bit for BMW and MINI EGR valves

- For operating the EGR valve screw connection on BMW and MINI diesel engines N47 · N57 · B37 · B47 · B57
- Long, thin blade for areas with difficult access – it is not necessary to combine different tools
- Output: tamper-resistant TORX® profile T30H
- With knurling
- For manual operation

T30H



6.3 1/4"

∅  
6 mm

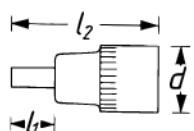

$d$ mm	$l_1$ mm	$l_2$ mm
11.5	194	213

Made in Germany  
8502LG-T30H  
EAN-No. 4000896246076

8.10€<sup>\*</sup>  
net



## Releasing tool for VAG cooling water expansion tank cover

12<sup>5</sup> 1/2



- Optimally fitting release tool for tank cover
- Problem-free loosening even of very tightly fitted covers
- No damage to the cover, as with unsuitable releasing tools such as pliers
- For VW and Group vehicles as well as electric and hybrid models
- Manual operation is only possible with great difficulty due to the geometric shape (low overall height) of the cover and the recessed seat in the expansion tank
- Width 108 mm, depth 36.4 mm

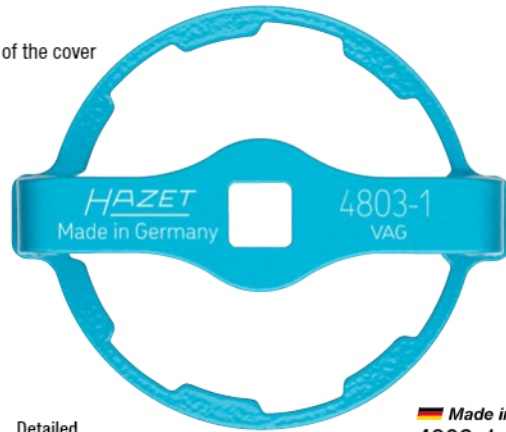

**Made in Germany**  
4803-1  
EAN-No. 4000896250158

**21.-€\***  
net

## Unlocking tool for VAG plug connections

- Damage-free unlocking of electrical plug connections on various components and sensors
- VAG group plug connections, e.g. injectors, rail pressure sensors, fluid level sensors, ignition coils, vacuum sensors, brake wear sensors, pressure regulators and lighting systems

• Length: 130 mm  
**Made in Germany**  
4675-1  
EAN-No. 4000896244331

**23.40€\***  
net



• Head offset: 20 mm  
• Length: 191 mm  
**Made in Germany**  
4675-2  
EAN-No. 4000896244348

**23.40€\***  
net

Extra-long blade, curved at the head, allows access to hard-to-reach places!

## VAG pencil coil extractor

- Fast and safe extraction of the pencil coils
- Removal of pencil coils e.g. on 1.0 l · 1.0 l TSI · TFSI · TGI · GTI · CNG · 1.2 l TSI · 1.4 l · 25 · 30 · 35 · 40 · 45 TSI · TFSI · TGI · CNG · GTE · Mild Hybrid · e-Hybrid · 1.6 l · 1.6 l SRE · MPI 2.0 l GTI
- Removal of both ignition coil versions possible:  
– 04C.905.110.J → 2017 from VAG engines  
– 04E.905.110.K 2017 → from VAG engines

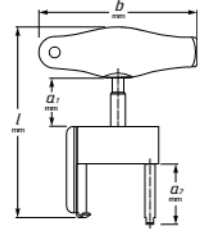

a <sub>1</sub> mm	a <sub>2</sub> mm	b mm	l mm
32	40	105	126



**Made in Germany**  
1849-12A  
EAN-No. 4000896247387

**57.80€\***  
net

## VAG suction pipe / special wrench

- Operation of difficult to access fastening screw on the intake manifold (behind the high-pressure pump)
- Designed as a "suitcase handle", enabling the screw connections to be easily tightened with torque
- Surface: chrome-plated
- For e.g. 3-cylinder 1.4 l common rail engines  
– AUDI A1 model years 2014 → 2018  
– SEAT Ibiza 4 model years 2015 →  
– VW Polo 5 model years 2014 → 2017  
– ŠKODA Fabia 3 model years 2014 → 2018 · Rapid model years 2015 → 2018



a <sub>1</sub> mm	a <sub>2</sub> mm	l mm
60	76.5	166

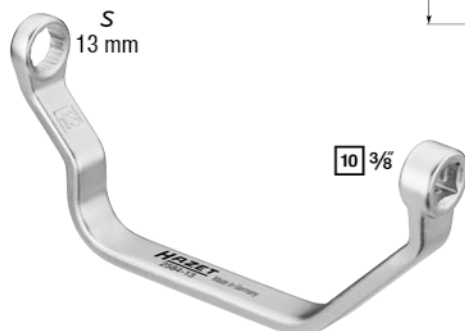

**Made in Germany**  
2584-13  
EAN-No. 4000896246779

**21.60€\***  
net

## Pipe stopper set

4

- Sealing pipelines in brake systems, air conditioning systems, power steering and fuel systems that cannot be secured with a flexible hose clamp
- Sealing of pipes and preventing the escape of fluids
- Sealing in sizes of 6.3 mm (1/4") · 8 mm (5/16") · 10 mm (3/8") and for double sealing (e.g. banjo connections) in sizes of 10 mm (3/8")



4591/4  
EAN-No. 4000896219650

**18.70€\***  
net



### 1/2" impact socket, hexagon

- Plastic insert to protect the surface of the wheel bolts
- Length: 85 mm



• Made in Germany  
**903SLG-17**  
EAN-No. 4000896045822

**17.60€\***  
net



• Made in Germany  
**903SLG-19**  
EAN-No. 4000896045839

**18.40€\***  
net



• Made in Germany  
**903SLG-21**  
EAN-No. 4000896055135

**18.40€\***  
net



• Made in Germany  
**903SLG-22**  
EAN-No. 4000896155453

**22.90€\***  
net



- Extra long: 130 mm

• Made in Germany  
**904SLG-17**  
EAN-No. 4000896100576

**46.90€\***  
net

• Made in Germany  
**904SLG-19**  
EAN-No. 4000896203710

**46.90€\***  
net

### 1/2" sets

3 sockets each in a practical storage box



• s 17 mm (3x)

• Made in Germany  
**903SLG-17/3**  
EAN-No. 4000896191697

**39.50€\***  
net



• s 19 mm (3x)

• Made in Germany  
**903SLG-19/3**  
EAN-No. 4000896191734

**44.70€\***  
net



• s 17 mm · s 19 mm · s 21 mm

• Made in Germany  
**903SPC/3**  
EAN-No. 4000896128754

**39.-€\***  
net

### Special profile

- Length: 86 mm



• s 17 mm

- MERCEDES-BENZ
- Made in Germany  
**905SLG-17**  
EAN-No. 4000896198795

**14.50€\***  
net



• s 21 mm

- KIA & HYUNDAI
- Made in Germany  
**905SLG-21**  
EAN-No. 4000896201624

**15.90€\***  
net

### 1/2" socket for FORD wheel bolt

- Releasing tool can be used on both sides on FORD models
- If the chrome cover is missing or damaged, the wheel nut can no longer be operated with the normal socket
- Solution: two double sockets instead of four single sockets
- Surface: phosphatised, oiled

#### 2-piece set:

- 900SLG-18 x 20 socket
- 917S-3 extension



• Made in Germany  
**900SLG-18X20/2**  
EAN-No. 4000896242023

**28.90€\***  
net

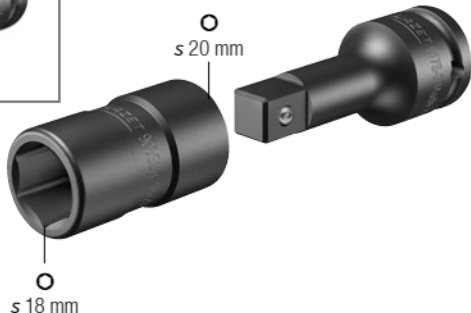

• s 18 mm

2

#### 3-piece set:

- 900SLG-18 x 20 socket
- 900SLG-20 x 22 socket
- 917S-3 extension

• Made in Germany  
**900SLG-1822/3**  
EAN-No. 4000896246274

**37.50€\***  
net



• s 18 mm

• s 22 mm

12.5 1/2

### One power adapter – many possibilities!



### XZN profile set



- Screw connections on commercial vehicles and passenger cars with XZN profile e.g. on chassis, brake system (brake carriers), engines, shock absorbers and camshaft sprocket
- M14 · M16 · M18

Made in Germany

990S/11

EAN-No. 4000896162406

115.-€  
net



### Hexagon profile set



- For screw connections on commercial vehicles and passenger cars, e.g. on chassis, brake system (brake carriers), engines and shock absorbers
- s 14 · 17 · 19 mm

Made in Germany

985S/11

EAN-No. 4000896211951

129.-€  
net



### Traction profile set 12-point

- s 19 · 21 · 22 · 24 · 27 · 30 · 32 · 36 mm

Made in Germany

900SZ6/11

EAN-No. 4000896225378

143.90€  
net



### 1/2" supplement to 985S/11

- Drive: either 1/2" or 24 mm



s 22 mm

Made in Germany

985S-22

EAN-No. 4000896218219

16.90€  
net



s 24 mm

Made in Germany

985S-24

EAN-No. 4000896218226

17.30€  
net

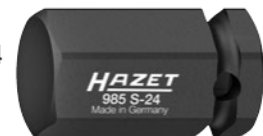

### 3/4" adapter on 1/2"

- Replaceable plug-in blades ● 24 mm – ■ drive 12.5 = 1/2"
- With borehole for locking pin or safety spring and groove for O-ring
- Surface: phosphatised, oiled

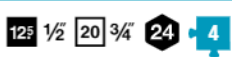

Made in Germany

1007S-7/4

EAN-No. 4000896215416

40.90€  
net



### 1/2" socket, hexagon

- Length: 85 mm



Made in Germany

903SLG6-17

EAN-No. 4000896223596

23.50€  
net

s 17 mm



Made in Germany

903SLG6-19

EAN-No. 4000896223589

23.50€  
net

s 19 mm

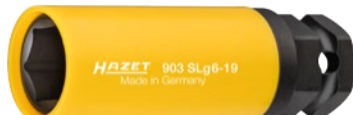

### Impact socket set

- s 19–36 mm

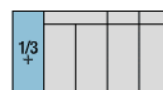

900SZ6  
s 19 · 21 · 22 · 24 · 27 · 30 · 32 · 36 mm

985S  
s 14 · 17 · 19 mm

990S  
M14 · M16 · M18

985S  
s 14 · 17 · 19 mm

990S  
M14 · M16 · M18

Made in Germany

163-570/24

EAN-No. 4000896233441

335.-€  
net





## Tyre inflators

### Calibrated

- Manometer measuring range: 0–12 bar, graduation: 0.1 bar
- Max. pressure: 12 bar
- Temperature range: -20°C to 60°C
- Hose with plug-in nipple
- Measuring tolerance: -15°C – 25°C, 0 – 4 bar: ±0.08 bar, 4 – 12 bar: ±0.16 bar
- Hose length: 1,000 mm



Calibrated device with optimally readable, large manometer!

9041G-1

EAN-No. 4000896212385

79.90€<sup>\*</sup>  
net



Ø 80 mm

### Digital

- Manometer measuring range: 0–12 bar, graduation: 0.01 bar
- Max. pressure: 12 bar
- Temperature range: -20°C to 50°C
- Display toggles between bar / PSI / kg/cm<sup>2</sup>
- Hose with plug-in nipple
- Measuring tolerance: -15°C – 25°C: ±0.1 bar
- Hose length: 400 mm



9041D-1

EAN-No. 4000896212378

79.90€<sup>\*</sup>  
net



Ø 63 mm

### Standard

- Manometer measuring range: 0–12 bar, graduation: 0.1 bar
- Max. pressure: 12 bar
- Temperature range: -10°C – 40°C
- Hose with plug-in nipple
- Measuring tolerance: -15°C – 25°C: ±0.3 bar
- Hose length: 400 mm



9041-1

EAN-No. 4000896147076

33.80€<sup>\*</sup>  
net



Ø 63 mm

## Wheel hub grinder

2

- With 1/2" inside square collet for attachment e.g. to pneumatic, cordless and corded impact wrenches
- For passenger car wheel hubs up to 160 mm Ø
- Internal diameter: 75 mm Ø



4960V-160/2

EAN-No. 4000896218394

68.60€<sup>\*</sup>  
net

2-piece set:

- 1 base unit
- 1 grinding wheel

Ø 160 mm

## Wheel hub grinder

4

- 11 mm outside hexagon with 3 contact surfaces for attachment e.g. to pneumatic, cordless and corded drilling machines
- For passenger car wheel hubs up to 160 mm Ø
- Internal diameter: 75 mm Ø



4960R-160/4

EAN-No. 4000896218820

110.90€<sup>\*</sup>  
net

4-piece set:

- 1 base unit
- 3 grinding wheels

Ø 160 mm

## Rim flange cleaner

2

- 11 mm outside hexagon with 3 contact surfaces for attachment e.g. to pneumatic, cordless and corded drilling machines
- For wheel centring diameter: at least 51 mm
- External diameter up to 160 mm Ø



4960F-160/2

EAN-No. 4000896218387

75.90€<sup>\*</sup>  
net

2-piece set:

- 1 base unit
- 1 grinding wheel

Ø 160 mm



## Brake calliper brush

- Removing stubborn brake dust and dirt from the disc brake calliper
- Plastic handle with suspension hole
- Length: 225 mm



Made in Germany  
4968-2

EAN-No. 4000896084821

**9.90€\***  
net



## Brass brake calliper brush

- Cleaning aluminium brake callipers
- Soft brass bristles facilitate damage-free cleaning
- Plastic handle with suspension hole
- Length: 225 mm



Made in Germany  
4968-3

EAN-No. 4000896089147

**13.90€\***  
net



## Hook set

- Securely hanging dismantled components, e.g. brake callipers, avoids damage to brake hoses, lines etc.
- Hook Ø 7 mm
- Surface: dip coated
- Length: 190 mm



4968/2H

EAN-No. 4000896221820

**11.50€\***  
net

2

## Brake test tool set

- Checking the lateral run-out of the brake disc
- Micrometer screw for exact determination of the thickness of the brake disc
- Precision dial gauge for checking the lateral run-out
- Hinged bracket with magnetic base as mounting and for an exact positioning of the dial gauge on the vehicle



4968/3

EAN-No. 4000896149179

**159.-€\***  
net



3

## Calliper gauge for brake discs / thickness gauge

- Measurement without wheel removal
- Effortless measurement on the vehicle during direct reception in the presence of the customer
- Also suitable for application on commercial vehicles
- Length: 395 mm

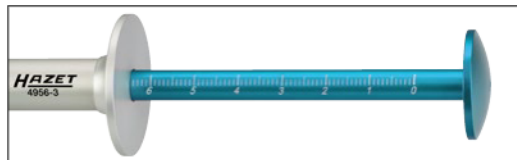

Measuring range:  
0 – 60 mm

4956-3

EAN-No. 4000896219032

**45.70€\***  
net



## Calliper gauge for brake discs

- Simple, quick determination of the brake disc diameter through wheel opening without removing the wheels
- Length: 450 mm

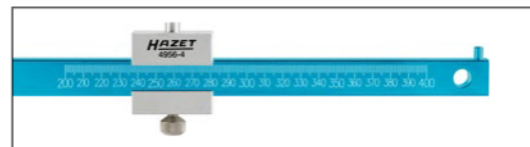

Measuring range:  
200 – 400 mm

4956-4

EAN-No. 4000896222339

**85.-€\***  
net

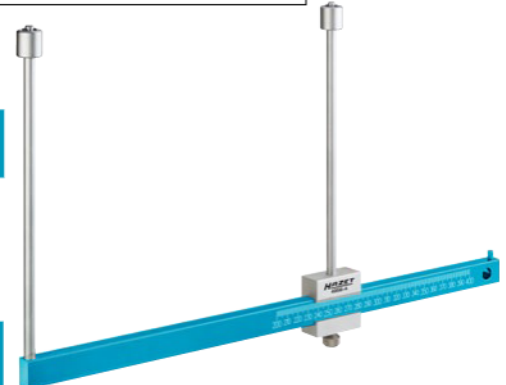



## Brake piston readjusting tool set, pneumatic

- Readjusting brake pistons on floating calliper systems with or without locking device for hand brakes
- Universal application thanks to 3-piece adapter set. Optimisation of the HAZET basic unit 4970P-1
- For clockwise and anti-clockwise brake pistons
- Largest possible recovery movement of the piston rod as far as into the housing – operation also when brake piston is extended far
- For smallest brake callipers **MINI**, **BMW 1 Series** to **BMW X7** (largest brake calliper at present)
- Pneumatic support together with swivelling rotary level allows effortlessly easy and quick resetting
- It is possible to simultaneously press and turn or only press the brake piston after the brake pads on disc brake systems have been replaced
- Included adapter set 4970P-02/3 ensures flexible accommodation of pressure plates from other manufacturers available on the market, e.g: hexagon socket adapter s 13 mm for HAZET pressure plates of product group 4970
- 10 mm (3/8") Outside square adapter to connect OEM special adapters e.g. all current **MINI** and **BMW** adapters · SW-Stahl
- 2-pin adapter for, among others, VIGOR · SW-Stahl · KS-Tools · BGS · Kunzer

### 2-piece set:

- Basic unit 4970P-1
- Adapter set 4970P-02/3



### Universal application with 3-piece adapter set!

Included adapter set 4970P-02/3 ensures flexible accommodation for pressure plates of other manufacturers available on the market, e.g:

- ① Inside hexagon adapter s 13 mm for HAZET adapter of group 4970 or adapter set 4970/5
- ② 10 mm 3/8" outside square adapters to connect OEM special adapters e.g. all current Mini and BMW adapters, BMW 1 series up to BMW X7 brake callipers (current largest calliper), SW-Stahl
- ③ 2-pin adapters e.g. for VIGOR, SW-Stahl, KS-Tools, BGS, Kunzer

### 4970P-1/4

EAN-No. 4000896232970

136.50€<sup>\*</sup>  
net



## Pressure plate set

- Readjusting brake pistons on floating calliper systems with or without locking device for hand brakes
- Universal application for numerous vehicles
- In conjunction e.g. with brake piston readjusting tool set 4970P-1/4 and 4970-1
- Please consider manufacturer's data and brake calliper design



### Suitable for use with 4970P-1/4 and 4970-1

Made in Germany

### 4970/5

EAN-No. 4000896235544

82.60€<sup>\*</sup>  
net

Tool finder



## Adapter plate set

- Adapter plate set for brake piston readjusting tool 4971-1 for damage-free resetting of twin piston brake callipers
- Extension of width of supporting surface to 100 x 72 mm
- Easy fixing of the adapter plates using 2 disc magnets: x 20 mm (holding force per magnet: 2 kg)
- Surface: galvanised

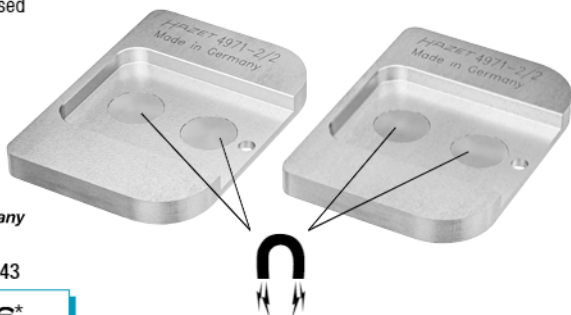

Made in Germany

### 4971-2/2

EAN-No. 4000896246243

76.10€<sup>\*</sup>  
net

## Brake piston readjusting tool

- For damage-free readjusting brake pistons (floating callipers/fixed callipers) on disc brakes
- For common vehicle types without integrated locking device for handbrakes
- Avoids damage of the boots and pistons
- High accuracy as well as high stability allow continuous use
- Reduced expenditure of force due to exact guiding



Made in Germany

### 4971-1

EAN-No. 4000896156245

153.50€<sup>\*</sup>  
net



### Circlip pliers set

- Correct, centred insertion of the circlip, e.g. when mounting the joint on the drive shaft
- Easy, damage-free assembly of the drive shaft joint: damage to the serration of joint and shaft is avoided with internal circlip during assembly of the drive shaft joint
- Easy fixing of the locking pliers with the circlip
- The pliers automatically slip down when striking the joint
- For drive shafts from all manufacturers
- One-hand operation of the pliers
- No other tools needed

#### 15-piece set:

- Circlip pliers 1847-12
- 7 half shell pairs:  $\varnothing$ : 19 · 21.4 · 22.3–23 · 23.8–24.6 · 26.2–26.9 · 28.5–29.2 · 30 mm



15



#### Application tip:

- Insert appropriate half shells (shaft diameter) in pliers
- Place pliers on serration with pre-assembled circlip and clamp
- Pre-positioning of the joint due to conical shape of the pliers makes it easier to introduce the serration without damage.



Made in Germany

1847-12/15

EAN-No. 4000896221288

344.–€  
net

In partnership with  
**NTN** **SNR**

### Supplement for 1847-12/15

### Half shell pair

- Easy, damage-free installation of the drive shaft joint to VW T5 · T6
- $\varnothing$  32.8 mm

Made in Germany

1847-128/2

EAN-No. 4000896242009

44.60€  
net

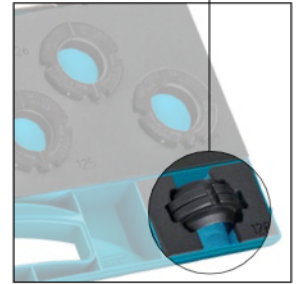
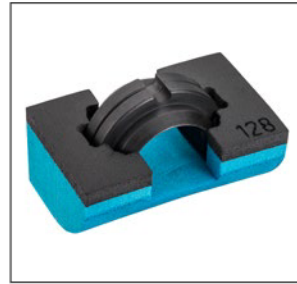

### Clamp pliers for axle boots

- Installing axle boots made of Hytrel and clamps made of special stainless steel with pre-set torque tightening values together with e.g. torque wrench HAZET 6110-1CT
- For VW, AUDI, SEAT, ŠKODA, OPEL/VAUXHALL, FORD, etc.
- Ergonomically shaped HAZET 2-component handle
- Drive: square 10 mm (3/8")
- Length: 178 mm

10 3/8"

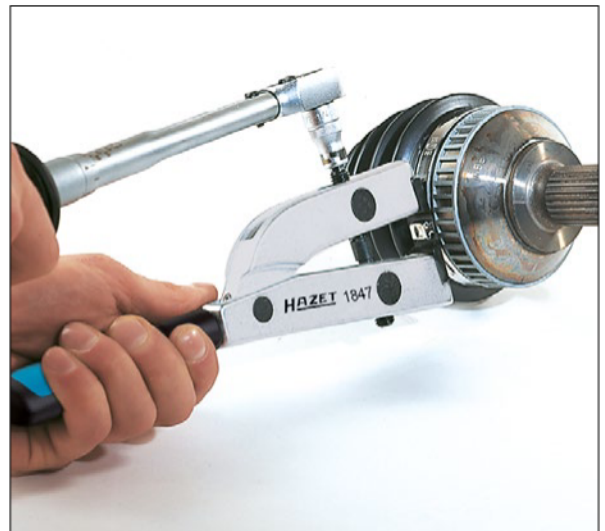

Made in Germany

1847

EAN-No. 4000896050918

154.80€  
net





## Drive shaft disassembly / assembly set

12

- Disconnecting the drive shaft joint and pulling in the shaft through the wheel hub with just one tool
- Disconnecting the drive shaft joint from the shaft using the sleeves or spindles together with HAZET sliding hammer 4797-1 (not included in delivery)
- Pulling in the drive shaft through the wheel hub on vehicles where the drive shaft is very difficult to pull through the wheel hub
- Suitable for all vehicle brands
- For drive shafts with outside and inside thread

### 12-piece set:

- 2 spindles (M14, M16) to pull the drive shaft through the wheel hub or separate the joint from the drive shaft when the joint has an internal thread
- 2 sleeves to support it on the wheel hub
- 1 spindle nut
- 7 screw sleeve adapters:
  - M16 x 1.5 VAG, MAZDA
  - M18 x 1.5 Volvo, SUZUKI, OPEL
  - M20 x 1.5 MERCEDES-BENZ, VAG, MITSUBISHI, MAZDA
  - M22 x 1.5 FIAT, PSA, BMW, FORD, OPEL, HYUNDAI
  - M24 x 1.5 RENAULT, BMW, MERCEDES-BENZ, OPEL, MAZDA, HONDA, VAG
  - M27 x 1.5 PSA, BMW, FORD
  - M30 x 1.5 MERCEDES-BENZ, PSA, BMW



In partnership with  
**NTN. SNR**

Made in Germany  
4935-11/12  
EAN-No. 4000896217434

344.-€<sup>\*</sup><sub>net</sub>



## Impact extractor

- M16 x 1.5
- Striking weight: 1.8 kg
- Surface: galvanised (Cr6-free)
- Length: 460 mm

Made in Germany  
4797-1  
EAN-No. 4000896121175

112.50€<sup>\*</sup><sub>net</sub>



Suitable for use with  
4935-11/12



## Universal spreader

- Universal application due to wide spreading range 5 – 11.5 mm
- Expansion of the spring strut and ball joint mounting (separating the spring strut from the wheel bearing housing)
- For manual operation
- Dimensions: L 60 x H 30 x W 24 mm

6.3 1/4"

**NEW!**

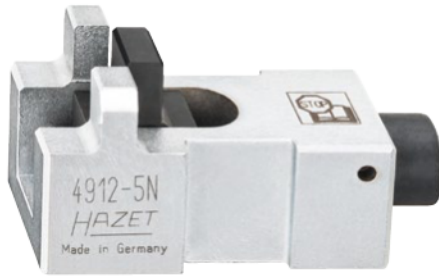

Made in Germany

4912-5N

EAN-No. 4000896249312

**54.-€\***  
net

**Our original – now even better!**

- ▶ Optimised end stops with inspection window
- ▶ Drive with 1/4" holder for overload protection
- ▶ Robust, reinforced design
- ▶ Compact design

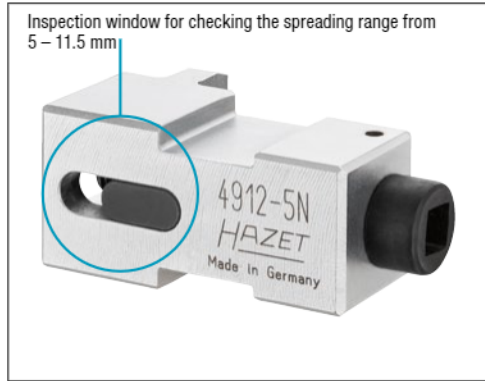

Inspection window for checking the spreading range from 5 – 11.5 mm



Now with chamfered edge for optimised insertion of the spreader into the steering knuckle!

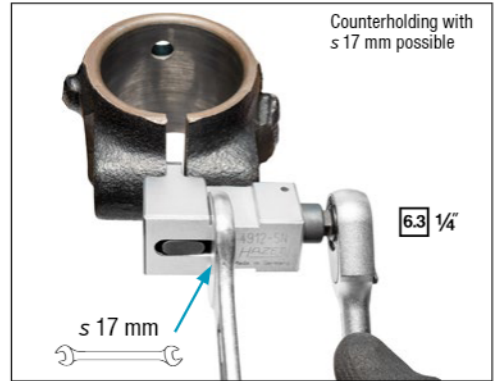
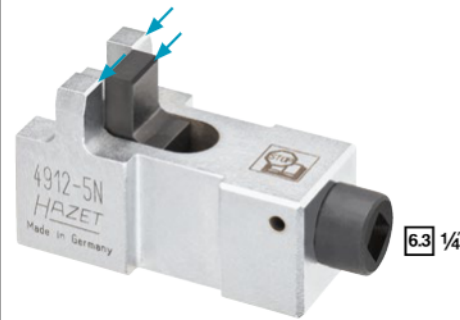

Counterholding with s 17 mm possible

s 17 mm

## 1/2" impact socket set with 21 mm special profile

- For the operation of lightweight nuts with special profile for rear axle screw connections / camber adjustment, e.g. AUDI A4 B9 model year 2015 → A6 C8 model year 2018 →
- Optimised special profile for damage-free attachment of the flat-head lightweight nuts
- Surface: phosphatised
- Output: groove profile
- For impact operation

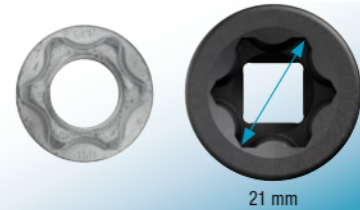

21 mm

Made in Germany

2521S-1

EAN-No. 4000896246571

**7.50€\***  
net

$d_1$ mm	$d_2$ mm	$l$ mm	$t$ mm
31	30	40	15

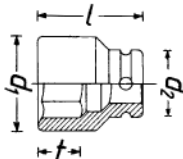

21 mm



12.5 1/2"

## 3/8" drive shaft screwdriver socket, VAG

- Operation of the heat protection plate fastening screws when removing the drive shaft and screwing the right-hand drive shaft / stub shaft / flanged shaft on VAG all-wheel drive vehicles
- Save significant time with the use of this tool
- Due to the restricted installation conditions, removal of the drive shaft is not possible without this tool
- Torque-controlled screw tightening, e.g. with HAZET 5110-3CT possible (please follow the manufacturer's specifications)
- Extra long design
- For manual operation

Ø S 6 mm



Made in Germany

2584LG-1

EAN-No. 4000896246298

**21.90€\***  
net

$d$ mm	$l_1$ mm	$l_2$ mm
19	300	327

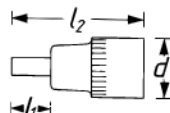



## Stationary universal spring vice set

### Innovative socket and installation concept

- Swivelling in horizontal or vertical working position
- HAZET recommendation for ergonomic working height: adjust vertically, operate horizontally
- Damage to shock absorbers and head plates impossible (no overload risk)
- Simple, lockable strut mount

### High safety

- Consistently reliable mounting of head plates
- Thread damage to piston rod impossible
- Permanent fixation of spring throughout operation

### Secured investment – by using existing components of SYSTEM 4900

- Existing basic units 4900-2 A and all tensioning jaws of System 4900 may be used
- Use of future applications is assured

### Allows record keeping by scaling

- If recurring, significant time savings by scaling
- Firm fixation eliminates readjustment at the same spring strut (left/right)

### 4 pieces, contents:

- Safety spring vice, basic unit 4900-2A
- Base support 4903-1
- Universal clamping disc, adjustable 4903-2
- 4903-3 universal tensioning jaw, adjustable, safety adapter included 4903-3

4



Adjust vertically, operate horizontally. Swivelling!



Made in Germany

4903/4

EAN-No. 4000896180561

2,585.-€<sup>\*</sup><sub>net</sub>

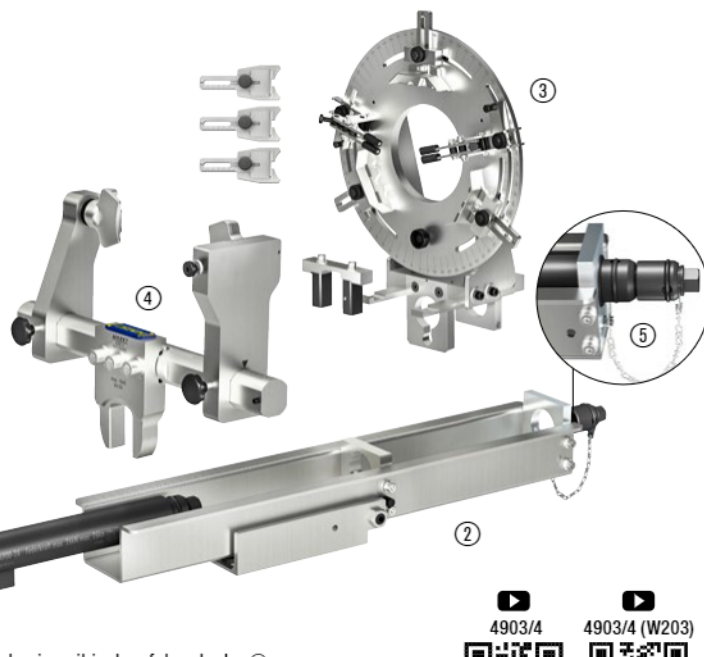

- ① 4900-2A basic unit incl. safety adapter ⑤
- ② 4903-1 basic support
- ③ 4903-2 clamping disc (adjustable)
- ④ 4903-3 tensioning jaw (adjustable)



## Safety spring vice set

- Installing and removing the coil spring when replacing shock absorbers
- Suitable for impact wrenches
- Suitable for around 100 different vehicle types
- Closed system – maintenance-free
- Variable system thanks to easily replaceable tensioning jaws
- Location bar for machinist's vice
- Maximum span: 309 mm

### 5 pieces, contents:

- Base support 4900-2A
- 2 tensioning jaws 4900-11
- 2 tensioning jaws 4900-12



5



Made in Germany

4900-2A/5

EAN-No. 4000896086054

1,062.-€<sup>\*</sup><sub>net</sub>





## Universal inside spring vice set

6

- Installation and removal of the coil spring on the rear axle
- Pendulum hexagonal head for even force distribution with integrated anti-twist protection for upper tensioning jaws
- One-sided counterholder for the spindle made possible by hexagon on top, e.g. with combination wrench HAZET 600 N-13
- Removal and installation of springs with small coil pitch, e.g. for MINI Cooper S (third generation), VW Passat (B8)
- Extension of the span to 120 mm and an increase of the maximum load for increasing vehicle weights (electric and hybrid vehicles), for safe working up to 31,000 N → Tested with at least four-fold safety against breakage (GS mark of tested safety)
- 17° swivel angle of the tensioning jaws now ensures the removal of C-shaped (bent) springs, e.g. on AUDI A4 (B9), VW Golf 7
- Internal and external guidance of the tensioning jaws prevents the spring from sliding out
- All tensioning jaws included, reusable, replaceable plastic protective pads



### 6-piece set, contents:

- 1 inside spring vice 4904-1
- 1 tensioning jaw 4904-10 · span 64 – 115 mm
- 1 tensioning jaw 4904-11 · span 64 – 115 mm
- 1 tensioning jaw 4904-12 · span 79.5 – 133 mm
- 1 tensioning jaw 4904-13 · span 79.5 – 133 mm
- 1 double-ended pipe socket 4902-224 · s 24 mm



Universal application on almost all passenger cars!

Only 202 mm long!

### Highlights:

- Easy handling for just one user
- Elimination of time-consuming work for most spring disassemblies:
  - Removal of axle parts unnecessary
  - Axle measurement no longer necessary
  - Removal and installation in a few minutes for each side
- **Summary:** compact HAZET design allows spring replacement on many vehicles with considerable time saving!

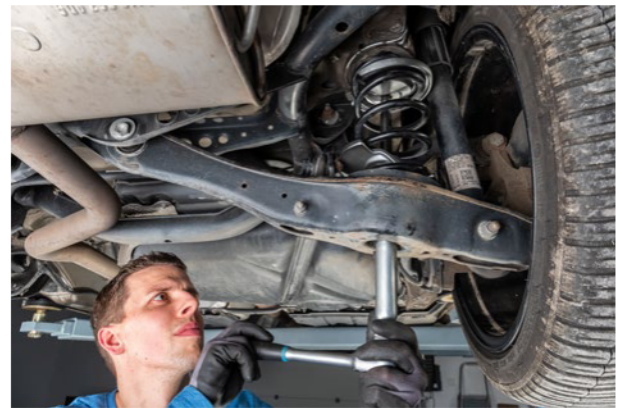
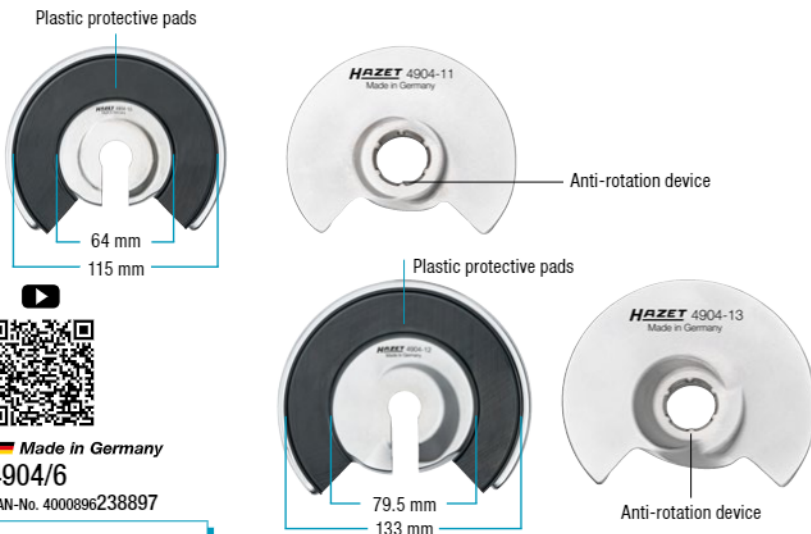

Made in Germany  
4904/6

EAN-No. 4000896238897

459.-€\*  
net

### Supplement

## Support device

- Prevents unwanted raising of the suspension during the spring tensioning process
- Can be used on almost all vehicles – helpful on vehicles with multi-link axle
- Protective pads prevent damage to the vehicle parts
- Facilitates removal of rear axle springs
- Safety: visual chain provides a reminder for tool removal
- Use together with universal inside spring vice set 4904/6
- Clamping range: 80 – 127 mm
- Pressure piece diameter: 30 mm
- Chain length: 750 mm



Made in Germany  
4912-6

EAN-No. 4000896238835

43.50€\*  
net

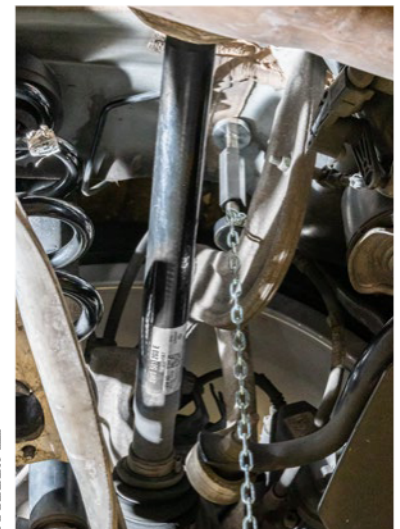



Assistent®

179NXL-8/440 with 440 expert tools



Stainless steel work surface  
EDELSTAHL®  
Rost frei

179NXL-8  
Made in Germany  
Wide design: 959 mm

4/3+

440



Das Werkzeug

179NXL-8/440

EAN-No. 4000896247974

4,379.-€\*  
net

Including

**HiPer**

6.3 1/4 10 3/8 12 1/2



163-606/259

Made exclusively for you by our professional specialists

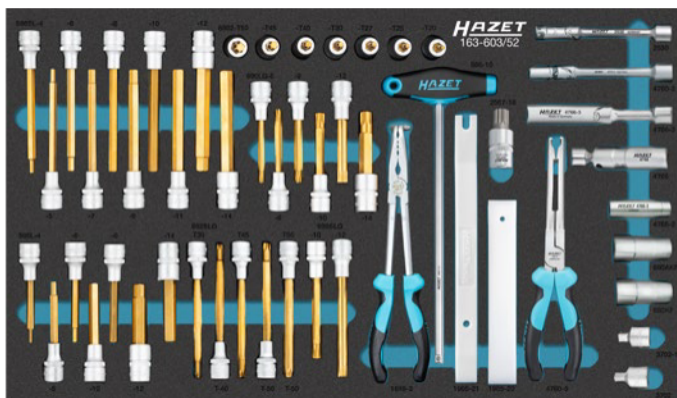

163-603/52

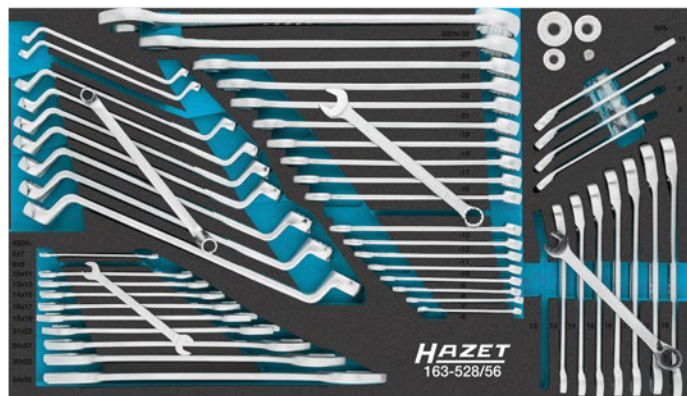

163-528/56 s 6x7 - 34x36 mm, s 6 - 32 mm, s 8 - 19 mm, s 6x7 - 24x27 mm



163-604/34



163-605/39

Perfect tool set for the passenger car / van workshop!

Your HAZET specialist dealer



\* Non-binding recommended retail prices (RRPs) excluding VAT; these replace all other RRPs during the promotion period. We accept no liability for printing errors. All rights reserved regarding technical modifications and errors, images may not always correspond to originals and are thus non-binding! © 2023

You can find further information on all items at: [www.hazet.de](http://www.hazet.de)

SWW23/EN/XX/1 1 02.23/2.5/JK/MD  
Copyright 2023 ©  
HAZET-WERK Hermann Zerver GmbH & Co KG  
Guldenwerther Bahnhofsstraße 25-29,  
D-42857 Remscheid, Germany