

KVALITETA PO NAJBOLJOJ CIJENI!

33 JAHRE
ANS-YEARS
1992-2025

KS TOOLS

TOP DEAL

Infinitool

**Uključujući
PODSJETNIK
ZA SERVIS**



Infinitool

516.9042

INFINITOOL Ustavljački
moment ključ

79,00

20 - 200 Nm

1/2"

1 - 5 Nm

1/4"

5 - 25 Nm

1/4"

10 - 50 Nm

3/8"

20 - 100 Nm

1/2"

60 - 350 Nm

1/2"

80 - 420 Nm

1/2"

110 - 550 Nm

3/4"

150 - 750 Nm

3/4"

200 - 1000 Nm

1"



Sve cijene u EUR, bez PDV-a, vrijede do 30.9.2025.

performance
plus



PERFORMANCE VAS ČINI USPJEŠNIM



P10

1850,00

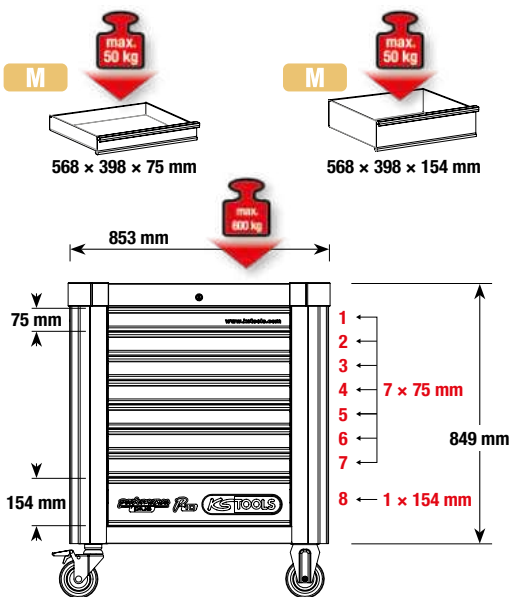

- es Držać papirnih rola
- sa držać za doze
- Stabilni kuglični ležaj
- Integrirana zaštita rubova
- Antistatički kotačići s kočnicom



810.4241 P10 radionička kolica s 241 alata



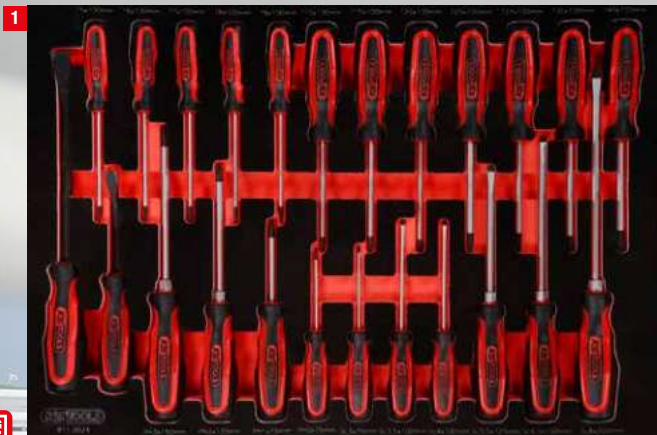

24 Odvijač-set



41 Set odvijača



159 1/4" + 3/8" + 1/2" utični ključ-set



17 Set kliješta, čekića i dljeteta

**PLASTIČNI ULOŽAK
ZA ČUVANJE
ZA SVA *performance*
RADIONIČKA
KOLICA**



Ostale informacije

875.9904

L mm	B mm	H mm
395	140	50

4 + 1 PREGRADAK

5,00



Ostale informacije

875.9905

L mm	B mm	H mm
395	140	50

5 PREGRADAKA

5,00



Ostale informacije

875.9908

L mm	B mm	H mm
395	280	50

8 PREGRADAKA

10,00



Ostale informacije

875.9912

L mm	B mm	H mm
395	280	50

12 PREGRADAKA

10,00



Ostale informacije

875.9918

L mm	B mm	H mm
395	280	50

18 PREGRADAKA

10,00



PERFORMANCE U DVA PAKETA!

KOJI JE VAŠ PERFORMANCE PAKET?





Ostale informacije

P10



OPTION

EDELSTAHL
ROSTFREI



Integrirana zaštita rubova

2800,00

810.7397 P10 radionička kolica s 397 alata





Ostale informacije

P15





OPTION

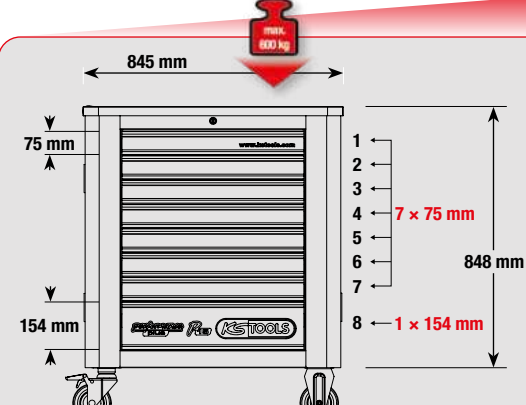

2900,00

815.7397 P15 radionička kolica s 397 alata



M max. 50 kg



568 x 398 x 75 mm

M max. 50 kg



568 x 398 x 154 mm



es Držač papirnih rola



sa držač za doze



Stabilni kuglični ležaj



Antistatički kotačići s kočnicom



**RADIONIČKA KOLICA
S PO 397 ALATA**

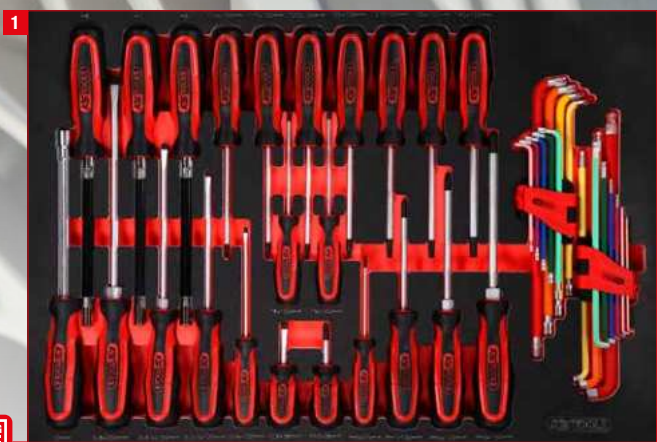

41 Odvijač-set



111 1/4" + 3/8" + 1/2" utični ključ-set

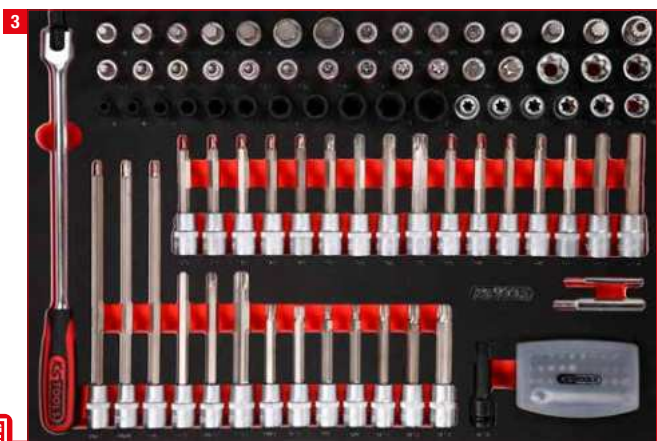

111 1/2" set bit nasadnih ključeva



41 Set odvijača



28 Kliješta i turpije-set



43 Set za servisiranje ulja i guma



22 Set čekića i dljeta

PERFORMANCE JE VAŠ PLUS

RAŠIRITE SE!



Ostale informacije

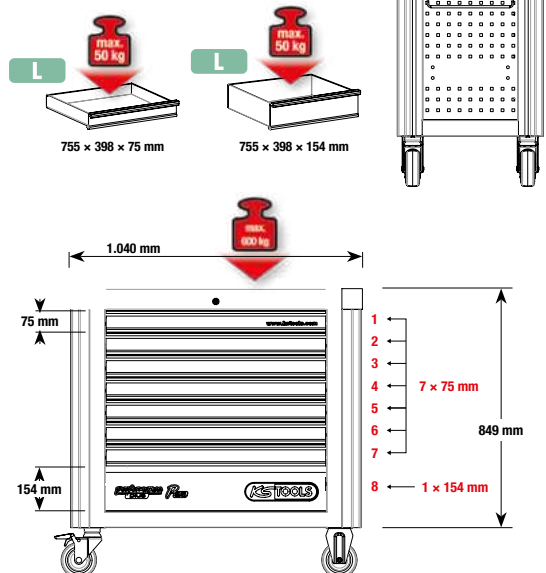

3945,⁰⁰

825.8564 P25 radionička kolica s 564 alata

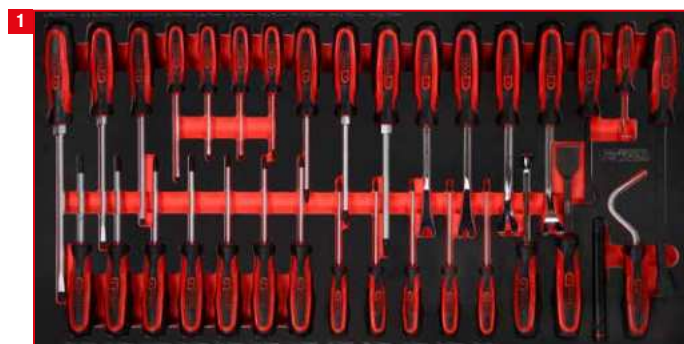

Odvijač-set



1/4" + 3/8" utični ključ-set



1/2" utični ključ-set



Set odvijača





Integrirana zaštita rubova



sa držač za doze



Stabilni kuglični ležaj



Antistatički kotačići s kočnicom



Brava može se zaključati



1 / 0
Option

SA **564**
ALATA



Set odvijača



Set odvijača i turpija



Set kliješta i mjeraca



Set čekića, dljeta i Kraft nasadnih ključeva



performance
plus

POWER I PERFORMANCE

S PRAVOM DUBINOM!

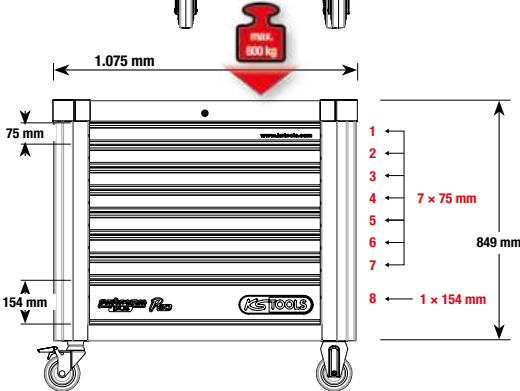
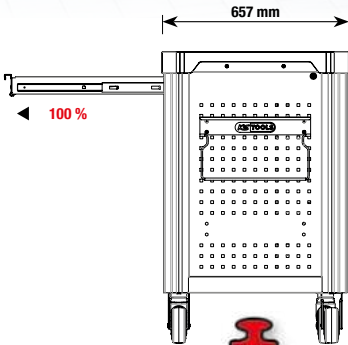
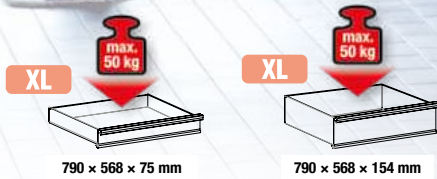

5890,⁰⁰

830.9706 P30 radionička kolica s 706 alata



Integrirana zaštita rubova



sa držač za doze



Antistatički kotačići s kočnicom



Stabilni kuglični ležaj



Brava može se zaključati

SA 706 ALATA

657 x 1.075 MM 4 x M & 5 x XL

M 1 2 3 4
568 x 388 mm

XL 5 6 7 8 9
782 x 568 mm



76 Set odvijača

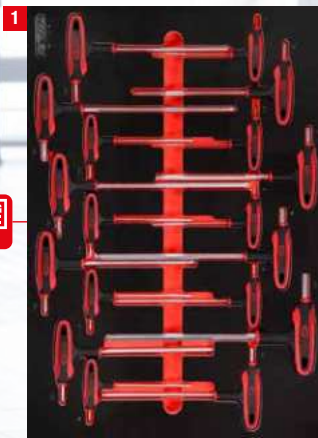

18

Set nasadnih ključeva s T-drškom

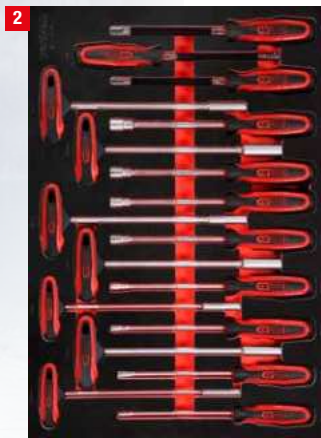

18

Set nasadnih ključeva s T-drškom



221 3/8" utični ključ-set



20

Set čekića i dlijeta



28

Set mjernih alata i turpija



149 1/2" utični ključ-set

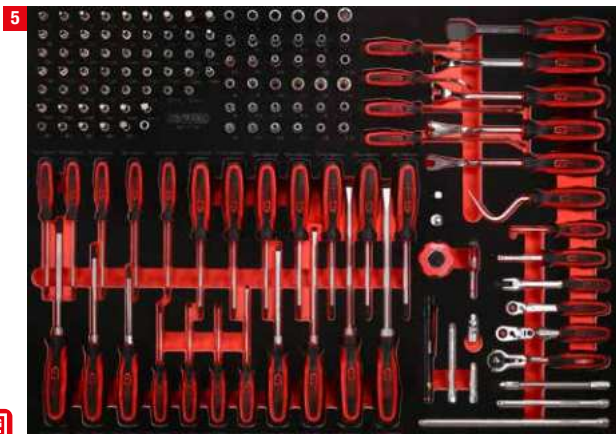

142 1/4" set utičnih ključeva i odvijača



34 Kliješta-set

KOLICA VELIKOG KAPACITETA!

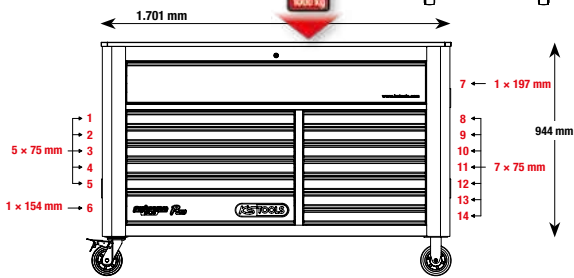
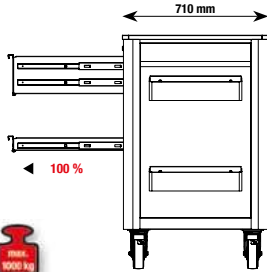

9100,00

845.14950 P45 radionička kolica s 950 alata

SA **950**
ALATA

7 x M

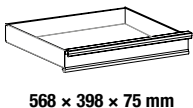

M



64

1/2" set bit nasadnih ključeva



19

Odvijač i kuka-set



39

1/2" set snažnih nasadnih ključeva



18

Set nasadnih ključeva s T-drškom



169

1/4" utični ključ-set



28

Set odvijača

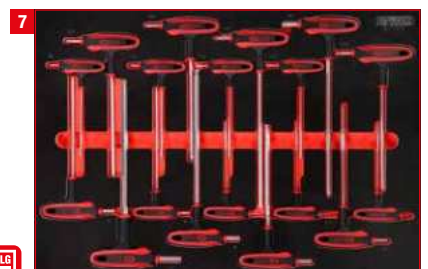

18

Set nasadnih ključeva s T-drškom



10
46
Odvijač-set



11
76
Set odvijača

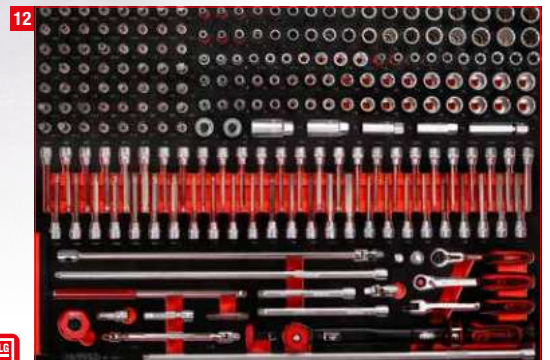

12
221
3/8" utični ključ-set



13
149
1/2" utični ključ-set



14
34
Kliješta-set

Integrirana zaštita rubova

sa držač za doze

Stabilni kuglični ležaj

Antistatički kotačići s kočnicom

Brava može se zaključati

1 / 0
Option

6 x XL

M
8 9

XL
10 11 12 13 14

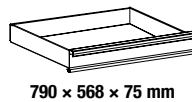
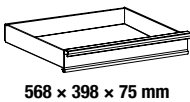

8 + 9



20
Set čekića i dljetva

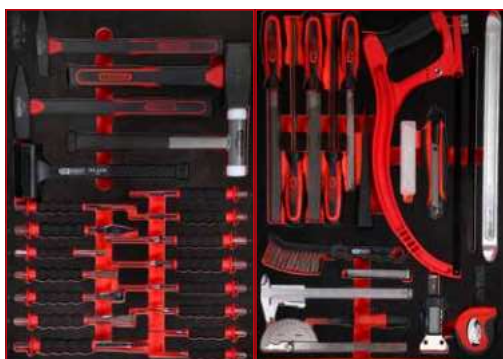

Set mjernih alata i turpija

28

VREME ZA NOVI AUTOMOBIL?

ECO *Line*

i  **1** 897.0007
Ostale informacije

BEZ ALATA

465,00

Tehnički podaci:	Eco Line 897.0007	Racing Line 826.0007
Ukupna nosivost:	300,0 kg	350,0 kg
opteretivost po ladicu:	25,0 kg	30,0 kg
samouvlačenjem i SOFT-CLOSE funkcijom:	✓	✗
Promjer kotača:	125,0 mm	125,0 mm
Alat za fiksiranje kotača:	✓	✓
S centralnim zaključavanjem:	✓	✓
pojedinačno zaključavanje:	✗	✓
visina:	1014,0 mm	976,0 mm
širina:	748 mm	788 mm
Dubina:	459,0 mm	496,0 mm
unutarnje dimenzije ladice:	565 x 395 mm	565 x 395 mm
s poliuretanskom zaštitom kutova i rubova:	✗	✓
Kvadratne perforacije za dijelove pribora:	✓	✓
Broj ladica:	7	7
debljina lima:	0,8 mm	0,9 mm
letve za hvatanje:	✓	✓
Izvlačenje ladica:	100 %	90 %
radna ploča s policama za sitne dijelove:	✗	✓
Radna ploča s ulošcima od pjene:	✓	✗
vodice ladica na kugličnim ležajevima:	✓	✓
s bočnom metalnom ručkom:	✓	✓

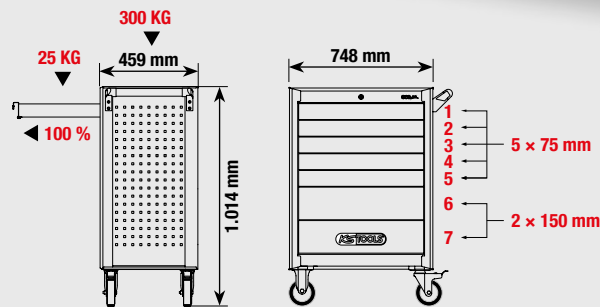

RACING *Line*

i  **1** 826.0007
Ostale informacije

BEZ ALATA

519,00

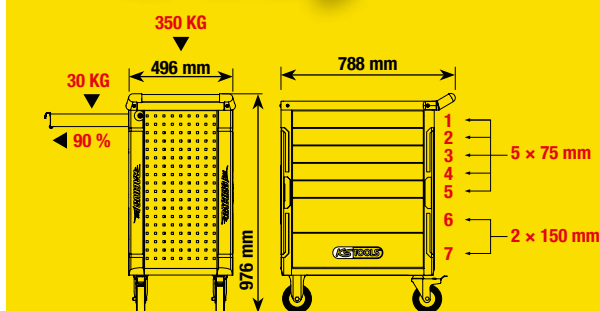

ECO *line*

Sa 7 ladica i 215 Premium alata

705,00

897.7215



STARTNI PAKET - 215 DIJELOVA

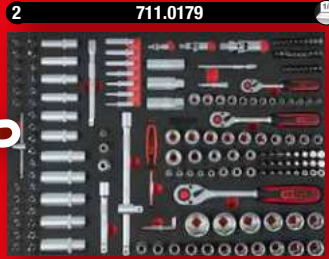
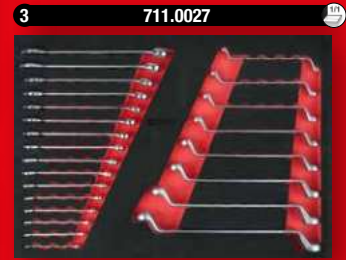

Ostale informacije

RACING *line*

Sa 7 ladica i 215 Premium alata

725,00

826.7215



UNIVERZALNI PAKET - 515 DIJELOVA

ECO *line*

Sa 7 ladica i 515 Premium alata

910,00

897.7515

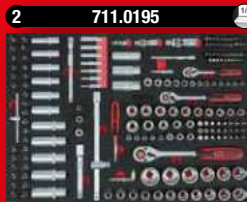
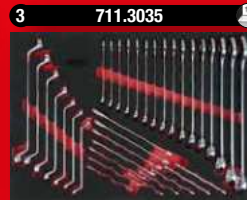

Ostale informacije

RACING *line*

Sa 7 ladica i 515 Premium alata

935,00

826.7515



ECO *line*

Sa 7 ladica i 598 Premium alata

1349,00

897.7598



POWER PAKET - 598 DIJELOVA

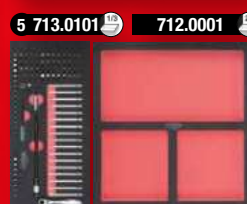
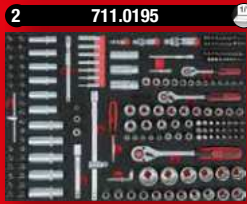

Ostale informacije

RACING *line*

Sa 7 ladica i 598 Premium alata

1400,00

826.7598



GOSPODAR PRSTENOVA



od 24,00

A	517.0048			8 · 9 · 10 · 11 · 13 · 14 17 · 19 mm	24,00 €
B	517.0052			8 · 9 · 10 · 11 · 12 · 13 · 14 15 · 16 · 17 · 18 · 19 mm	44,00 €
C	517.0043			6 · 7 · 8 · 9 · 10 · 11 · 12 13 · 14 · 15 · 16 · 17 · 18 19 · 20 · 21 · 22 · 24 · 27 30 · 32 mm	114,00 €

- bočno proklizavanje-profil
- položaj čeljusti 15° savijen
- prsten čeljusti 15° savijen
- polirane glave
- mat satinirano



- DIN 3110 / ISO 1085 / ISO 10102 / ISO 3318
- položaj čeljusti 15° savijen
- brušene glave
- mat satinirano
- krom vanadij



od 20,00

A	517.0148			6x7 · 8x9 · 10x11 · 12x13 14x15 · 16x17 · 18x19 20x22 mm	20,00 €
B	517.0123			6x7 · 8x9 · 10x11 · 12x13 14x15 · 16x17 · 18x19 20x22 · 21x23 · 24x27 30x32 mm	46,00 €
C	517.0125			6x7 · 8x9 · 10x11 · 12x13 14x15 · 16x17 · 18x19 20x22 · 21x23 · 24x27 25x28 · 30x32 mm	52,00 €



- 12-kutni
- DIN 838 / ISO 1085 / ISO 10104 / ISO 3318
- prsteni 75° koljenasti
- tanki zidovi
- polirane glave

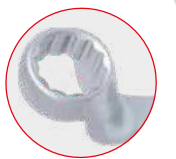

od 26,00

A	517.0248			6x7 · 8x9 · 10x11 · 12x13 14x15 · 16x17 · 18x19 20x22 mm	26,00 €
B	517.0222			6x7 · 8x9 · 10x11 · 12x13 14x15 · 16x17 · 18x19 20x22 · 21x23 · 24x27 30x32 mm	52,00 €



NEW

i **1**
Ostale informacije

517.0670	230 mm	42,00 €
517.0675	340 mm	50,00 €
517.0680	450 mm	105,00 €
517.0685	580 mm	160,00 €

od 42,00

REVERZIBILNI USTAVLJAČ 4U1

TOP SELLER

i **1**
Ostale informacije

10 mm
13 mm
17 mm
19 mm

20,00

503.4565 10 x 13 x 17 x 19 mm

L R **72** $\times 5^\circ$

SVE NA JEDNOM MJESTU

TOP SELLER

i **1**
Ostale informacije

Jednoručni multifunkcijski ključ

260 mm
114.0055
114-32 mm
8-17 mm

35,00

114.0055 8 · 9 · 10 · 11 · 12 · 13 · 14 · 15 · 16 · 17 · 18 · 19 · 20 · 21 · 22 · 23 · 24 · 25 · 26 · 27 · 28 · 29 · 30 · 31 · 32 mm

i **12**
Ostale informacije

72 $\times 5^\circ$

124,00

503.4665 8 · 9 · 10 · 11 · 12 · 13 · 14 · 15 · 16 · 17 · 18 · 19 mm

i **30**
Ostale informacije

12 x

TOP SELLER

12 x

5/16" x 13 mm
10 mm x 13 mm
1/4" x 10 mm

1/2"
3/8"
1/4"

175,00

503.4960 8 · 9 · 10 · 11 · 12 · 13 · 14 · 15 · 16 · 17 · 18 · 19 mm

NEW

i **1**
Ostale informacije

Slobodnohodni ustavljač:
RAD BEZ GRANICA!

1/4" 75 mm

20,00

912.1485

SKINI, SKINI!

72 \angle **5°**

i **2**
Ostale informacije

914.1412

305 - 445 mm

1/2" **+** 1/4"

173 - 223 mm

podesivo:
1/4" u 4 stupnja
1/2" u 6 stupnjeva

36,00

i **1**
Ostale informacije

914.1205

stupanj: 1 2 3 4 5 6

podesivo u 6 stupnjeva

1/2" **600 MM!**

460 - 600 mm

26,00

i **1**
Ostale informacije

52,00

1/2"

760 mm

918.1293

72 \angle **5°**

VITAK I JAK!

od 26,00

+

102 Nm

710 Nm

72 \angle **5°**

57,00

i **2**
Ostale informacije

920.0002

			Nm	↔	
A	920.1490		102	140 mm	26,00 €
B	920.3890		325	190 mm	31,00 €
C	920.1290		710	245 mm	38,00 €

-40%

1

31,00

80° 45° 1/4"

Ostale informacije



935.1490 1/4" 106 g 125 mm >110 Nm

2



1

31,00

80° 45° 1/4"

Ostale informacije



935.1495 1/4" 106 g 125 mm >100 Nm

1

41,00

96° 3,75° 3/8"

Ostale informacije



935.3890 3/8" 227 g 199 mm >365 Nm

3



PUNA USLUGA
10 GODINA
KSTOOLS
JAMSTVA
UZ ONLINE REGISTRACIJU

**ZAJAMČENO:
6 MONSTER ALATA
DO KRAJA ŽIVOTA!**



1

52,00

100° 3,6° 1/2"

Ostale informacije



935.1290 1/2" 567 g 275 mm >950 Nm

4

STRAŠNO JAKA OBITELJ!

Jače, brže, robustnije, kompaktnije, povoljnije. Bolje!
Šest dobrih razloga za naših šest Monster ustavljača! I sedmi razlog: dajemo vam 10 godina garancije na sve.

1

72,00

100° 3,6° 1/2"

Ostale informacije



935.1295 1/2" 757 g 425 mm >950 Nm

5

1

104,00

100° 3,6° 1/2"

Ostale informacije



TELESKOPSKI

406 431 457 482 508 533 557 582 607 635 mm

935.1285 1/2" 1.280 g 406 - 635 mm >950 Nm

6

i  **9**
Ostale informacije

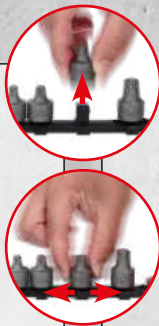

i  **10**
Ostale informacije

3/8" 

36,00



41,00

3/8" 



917.4000  4 - 5 - 6 - 7 - 8 - 9 - 10 - 12 - 14 mm

 T10 - T15 - T20 - T25 - T27 - T30 - T40 - T45 - T50 - T55 917.4015

i  **50**
Ostale informacije

POSEBNO KRATKA VARIJANTA

NEW

-  2 - 2,5 - 3 - 4 - 5 - 6
7 - 8 - 9 - 10 mm
-  M5 - M6 - M7 - M8 - M9
M10 - M12
-  T10 - T15 - T20 - T25 - T27
T30 - T40 - T45 - T47 - T50
-  PH1 - PH2 - PH3
-  6 - 10 mm
-  7/32" - 1/4"
5/16" - 3/8"
-  IPR20 - IPR25
IPR27 - IPR30
IPR40 - IPR45
-  IP10 - IP15 - IP20 - IP25
IP30 - IP40 - IP45 - IP50



35,00



911.1850 **1/4"**

i  **19**
Ostale informacije

49,00

NEW





























1/4" + 3/8" + 1/2"

 EPL4 - EPL5 - EPL6 - EPL7 - EPL8 - EPL10 - EPL11 - EPL12 - EPL14
EPL16 - EPL18 - EPL20 - EPL22 - EPL24 - EPL26 - EPL28 - EPL30 - EPL32

515.0119  EPL8,8

i  **77**
Ostale informacije

-  E 
-  EPL 
-  TX 
-  TB 
-  IP 
-  IPR 

5 x	 	1/4": E4 - E5 - E6 - E7 - E8
4 x	 	3/8": E10 - E12 - E14 - E16
4 x	 	1/2": E18 - E20 - E22 - E24
5 x	 	1/4": EPL4 - EPL5 - EPL6 - EPL7 EPL8
4 x	 	3/8": EPL10 - EPL12 - EPL14 EPL16
4 x	 	1/2": EPL18 - EPL20 - EPL22 EPL24
8 x	 	1/4": T6 - T8 - T10 - T15 - T20 T25 - T27 - T30
5 x	 	3/8": T40 - T45 - T47 - T50 - T55
2 x	 	1/2": T60 - T70
7 x	 	1/4": TB8 - TB10 - TB15 - TB20 TB25 - TB27 - TB30

4 x	 	3/8": TB40 - TB45 - T50 - T55
1 x	 	1/2": TB60
7 x	 	1/4": IP8 - IP10 - IP15 - IP20 IP25 - IP27 - IP30
3 x	 	3/8": IP40 - IP45 - IP50
2 x	 	1/2": IP55 - IP60
7 x	 	1/4": IPR8 - IPR10 - IPR15 IPR20 - IPR25 - IPR27 - IPR30
3 x	 	3/8": IPR40 - IPR45 - IPR50
2 x	 	1/2": IPR55 - IPR60

TOP SELLER



104,00

911.0077 **1/4"** **3/8"** **1/2"**

83,00

1/2"

A **HEX** **B** **RIBE** **C** **XZN** **D** **TORX**

A	911.4510		30	5 - 6 - 7 - 8 - 10 - 12 14 - 17 - 19 mm	83,00 €
B	911.4520		32	M5 - M6 - M7 - M8 M9 - M10 - M12 M13 - M14	83,00 €
C	911.4540		26	M5 - M6 - M8 - M9 M10 - M12 - M14 - M16	83,00 €
D	911.4550		32	T20 - T25 - T27 - T30 T40 - T45 - T50 - T55 T60 - T70	83,00 €

i **20**
Ostale informacije

1/2"

10 - 11 - 12 - 13 - 14 - 15
16 - 17 - 18 - 19 - 22 - 24
27 - 30 - 32 mm



62,00

911.0620

SETOVI DA SE ZALJUBIŠ

od **29,00**



A

B

1/4"

4 - 4,5 - 5 - 5,5 - 6 - 7 - 8 - 9
10 - 11 - 12 - 13 - 14 mm

A	917.0648		mat satinirano 48	29,00 €
B	918.0648		kromirano, visokog sjaja 48	31,00 €

od **83,00**



A

B

1/4" + 1/2"

4 - 4,5 - 5 - 5,5 - 6 - 7 - 8 - 9
10 - 11 - 12 - 13 - 14 - 15 - 16
17 - 18 - 19 - 20 - 21 - 22 - 23
24 - 27 - 30 - 32 mm

A	911.0694		mat satinirano 94	83,00 €
B	918.0694		kromirano, visokog sjaja 94	93,00 €

i  **108**
Ostale informacije



1/4" + 1/2"



 4 - 4,5 - 5 - 5,5 - 6 - 7 - 8 - 9
 10 - 11 - 12 - 13 - 14 - 15 - 16
 17 - 18 - 19 - 20 - 21 - 22 - 24
 27 - 30 - 32 mm

93,00

911.0708

i  **82**
Ostale informacije

ŠESTEROKUTNI DODATNI SET, DIMENZIJE INČA **NEW**



 5/32" - 3/16" - 7/32"
 1/4" - 9/32" 5/16"
 11/32" - 3/8" - 7/16"
 1/2" 9/16" - 5/8"
 11/16" - 3/4" - 13/16"
 7/8" - 9/16" - 5/8"
 11/16" - 3/4" 13/16"
 7/8" - 15/16" - 1"
 1.1/16" 1.1/8"
 1.3/16" - 1.1/4"

 5/32" - 3/16" - 7/32"
 1/4" - 9/32" 5/16"
 11/32" - 3/8" - 7/16"
 1/2" 9/16" - 5/8"
 11/16" - 3/4" - 13/16"
 7/8" - 9/16" - 5/8"
 11/16" - 3/4" 13/16"
 7/8" - 15/16" - 1"
 1.1/16" 1.1/8"
 1.3/16" - 1.1/4"

1/4" + 3/8" + 1/2"

90,00

917.0082

PROŠIRITE SVOJE MOGUĆNOSTI

i  **133**
Ostale informacije

90,00 **NEW**



1/4"	 4 - 4,5 - 5 - 5,5 - 6 - 7 - 8 - 9 - 10  11 - 12 - 13 - 14 mm  4 - 4,5 - 5 - 6 - 7 - 8 - 9 - 10 - 11  12 - 13 mm  E4 - E5 - E6 - E7 - E8 
3/8"	 9 - 10 - 11 - 12 - 13 - 14 - 15 - 16  17 - 18 - 19 mm  9 - 10 - 11 - 12 - 13 - 14 - 15 - 16  17 - 18 - 19 mm  E10 - E11 - E12 - E14 - E16 - E18 
1/2"	 9 - 10 - 11 - 12 - 13 - 14 - 15 - 16 - 17 - 18  19 - 20 - 21 - 22 - 23 - 24 - 27 - 30 - 32  34 - 36 mm  10 - 11 - 12 - 13 - 14 - 15 - 16  17 - 18 - 19 - 22 mm E20 - E22 - E24
1/4" - 3/8" 1/2"	50 - 100 - 125 - 250 mm
1/4" - 3/8" 1/2"	

1/4" + 3/8" + 1/2"

917.0133



Ostale informacije

1/4"		4 - 4,5 - 5 - 5,5 - 6 - 7 - 8 - 9 - 10 - 11 - 12 13 - 14 mm
1/4"		4 - 5 - 6 - 7 - 8 - 9 - 10 mm
		E4 - E5 - E6 - E7 - E8
3/8"		10 - 11 - 12 - 13 - 14 - 15 - 16 - 17 - 18 19 mm
3/8"		10 - 11 - 12 - 13 - 14 - 15 mm
		E10 - E11 - E12 - E14 - E16 - E18
1/2"		10 - 11 - 12 - 13 - 14 - 15 - 16 - 17 - 18 19 - 20 - 21 - 22 - 24 - 27 - 30 - 32 mm
1/2"		16 - 17 - 18 - 19 - 22 mm
		E20 - E24
1/4" 5/16"		
1/4" - 3/8" 1/2"		50 - 100 - 125 - 150 - 250 mm
1/4" - 3/8" 1/2"		1,3 - 1,5 - 2 - 2,5 - 3 - 4 - 5 mm
1/4" - 3/8" 1/2"		1/4" - 5/16"
1/4"		

1/4" + 3/8" + 1/2"



114,00

SLUČAJ ZA DVOJE!



1/4"		4 - 4,5 - 5 - 5,5 - 6 - 7 - 8 - 9 - 10 - 11 12 - 13 - 14 mm
1/4"		6 - 7 - 8 - 9 - 10 - 11 - 12 - 13 - 14 15 mm
3/8"		10 - 11 - 12 - 13 - 14 - 15 - 16 - 17 - 18 19 mm
3/8"		10 - 11 - 12 - 13 - 14 - 15 mm
1/2"		10 - 11 - 12 - 13 - 14 - 15 - 17 - 18 - 19 20 - 21 - 22 - 24 - 27 - 30 - 32 mm
1/2"		17 - 19 - 22 mm
1/4" 5/16"		
12 x		8 - 9 - 10 - 11 - 12 - 13 - 14 - 15 - 16 - 17 18 - 19 mm
1/4" - 3/8" 1/2"		1,3 - 1,5 - 2 - 2,5 - 3 - 4 - 5 mm
1/4" - 3/8" 1/2"		
1/4"		

1/4" + 3/8" + 1/2"

od
181,00

A	917.0216		mat satinirano	216	181,00 €
B	918.0216		kromirano, visokog sjaja	216	197,00 €

VAŠE KLJUČNE FIGURE TIJEKOM RADA

1/4"	4 - 4,5 - 5 - 5,5 - 6 - 7 - 8 9 - 10 - 11 - 12 - 13 14 mm
1/4"	4 - 5 - 6 - 7 - 8 - 9 - 10 mm ✱ E4 - E5 - E6 - E7 - E8
3/8"	10 - 11 - 12 - 13 - 14 - 15 16 - 17 - 18 - 19 mm
3/8"	10 - 11 - 12 - 13 - 14 - 15 mm ✱ E10 - E11 - E12 - E14 E16 - E18
1/2"	16 - 17 - 18 - 19 - 22 mm ✱ E20 - E24
1/4"	18 mm
1/4"	10 - 11 - 12 - 13 - 14 - 15 16 - 17 - 18 - 19 - 20 - 21 22 - 24 - 27 - 30 - 32 mm
1/2"	16 - 17 - 18 - 19 - 22 mm
1/4"	16 - 21 mm
1/4"	5/16"
1/4" - 3/8"	50 - 100 - 125 - 150 250 mm
1/2"	1,3 - 1,5 - 2 - 2,5 - 3 4 - 5 mm
1/4" - 3/8"	150 mm

1/4" + 3/8" + 1/2"

5°

R

L

72

A

B

124,00

TOP SELLER

A	917.0255		225		6-kutni + mm	4 - 4,5 - 5 - 5,5 - 6 - 7 - 8 - 9 - 10 - 11 12 - 13 - 14 - 15 - 16 - 17 - 18 - 19 - 20 21 - 22 - 24 - 27 - 30 - 32	124,00 €
B	916.0255		225		12-kutni + mm	4 - 4,5 - 5 - 5,5 - 6 - 7 - 8 - 9 - 10 - 11 12 - 13 - 14 - 15 - 16 - 17 - 18 - 19 - 20 21 - 22 - 24 - 27 - 30 - 32	124,00 €

3/4"

15°

R

L

24

A

B

C

od 228,00

A	911.0721		21		6-kutni + mm	19 - 21 - 22 - 23 - 24 - 26 - 27 - 29 - 30 - 32 - 35 36 - 38 - 41 - 46 - 50 mm	228,00 €
B	911.0722		21		12-kutni + mm	19 - 21 - 22 - 23 - 24 - 26 - 27 - 29 - 30 - 32 - 35 36 - 38 - 41 - 46 - 50 mm	258,00 €
C	911.0751		21		12-kutni + cola	3/4" - 13/16" - 7/8" - 15/16" - 1" - 1.1/16" - 1.1/8" - 1.3/16" 1.1/4" - 1.5/16" - 1.3/8" - 1.7/16" - 1.1/2" - 1.5/8" - 1.3/4" - 2"	258,00 €



Ostale informacije

1/2"



1/2"		10 - 11 - 12 - 13 - 14 - 15 - 16 - 17 18 - 19 - 20 - 21 - 22 - 24 mm
3 x		16 - 18 - 21 mm
14 x		6 - 7 - 8 - 9 - 10 - 11 - 12 - 13 - 14 15 - 16 - 17 - 18 - 19 mm
2 x		125 - 250 mm
1 x		3/8"Fx1/2"M
1 x		1/2"
5 x		3 - 5,5 - 8 mm PH1 - PH2
1 x		TB10 - TB15 - TB20 - TB25 - TB30 TB40 - TB45 - TB50
1 x		2 - 2,5 - 3 - 4 - 5 - 6 - 8 - 10 mm
1 x		6 - 24 V
1 x		240 mm
1 x		180 mm
1 x		300 g

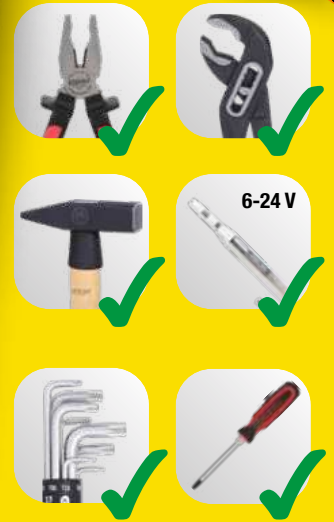

125,00

NEW

UNIVERZALNI GENIJI!

1/4"		4 - 4,5 - 5 - 5,5 - 6 - 7 - 8 - 9 - 10 11 - 12 - 13 mm
1/2"		10 - 11 - 12 - 13 - 14 - 15 - 16 - 17 19 - 20 - 21 - 22 - 24 - 27 - 30 - 32 mm
12 x		8 - 9 - 10 - 11 - 12 - 13 - 14 - 15 - 16 17 - 18 - 19 mm
2 x		1/4": 100 mm / 1/2": 125 mm
1 x		1/4" / 1/2"
7 x		3 - 4 - 5,5 - 6,5 mm PH0 - PH1 - PH2
1 x		T8 - T10 - T15 - T20 - T25 - T27 - T30 T40 - T45 - T50
1 x		1,5 - 2 - 2,5 - 3 - 4 - 5 - 6 - 8 - 10 mm
1 x		300 g
1 x		160 mm
1 x		200 mm



od 181,00



1/4" + 1/2"

A

B

A	917.0797		mat satinirano	97	181,00 €
B	918.0797		kromirano, visokog sjaja	97	197,00 €



62



Ostale informacije



1/4"		4 - 5 - 5,5 - 6 - 7 - 8 - 9 10 - 11 - 12 - 13 - 14 mm
5 x		8 - 10 - 13 - 17 - 19 mm
1 x		1/4": 100 mm
1 x		1/4"
4 x		3 - 5,5 mm PH1 - PH2
1 x		1/4"
1 x		1/4"
1 x		1,5 - 2 - 2,5 - 3 - 4 - 5 - 6 - 7 8 - 10 mm
1 x		100 - 500 V
1 x		160 mm
1 x		180 mm
1 x		250 mm
1 x		300 g

917.0062

1/4"



90,00

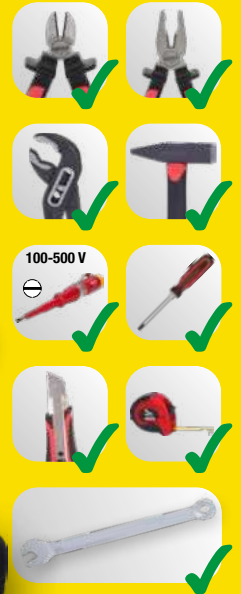

NEW

UVIJEK DOBRO OPREMLJENI



88



Ostale informacije



1/4"		4 - 4,5 - 5 - 5,5 - 6 - 7 - 8 - 9 10 - 11 - 12 - 13 mm
1/2"		14 - 15 - 16 - 17 - 18 - 19 - 20 21 - 22 - 23 - 24 - 25 - 26 - 27 28 - 30 - 32 mm
12 x		6 - 7 - 8 - 9 - 10 - 11 - 12 - 13 14 - 17 - 19 - 22 mm
3 x		1/4": 50 - 100 mm / 1/2": 125 mm
1 x		1/4"
4 x		6,5 - 8 mm PH1 - PH2
1 x		1/4"
1 x		1/4"
1 x		150 - 250 V
1 x		250 mm
1 x		180 mm
1 x		300 g

911.0688

1/4"

1/2"



197,00

TOP
SELLER



Ostale informacije

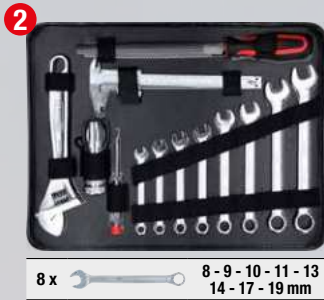

	4 - 4,5 - 5 - 5,5 - 6 - 7
	8 - 9 - 10 - 11 - 12
	13 - 14 mm
	1/4"
	1/2"
	10 - 13 - 14 - 16 - 17
	18 - 19 - 20 - 22 - 24
	27 - 30 - 32 mm

384,00

1/4" + 1/2"

911.0727



SVEMOGUĆI



Ostale informacije



	4 - 4,5 - 5 - 5,5 - 6 - 7
	8 - 9 - 10 - 11 - 12
	13 mm
	1/4"
	1/2"
	10 - 13 - 14 - 15 - 16
	17 - 18 - 19 - 21 - 22
	24 - 27 - 30 - 32 mm
	8 - 10 - 11 - 12 - 13
	14 - 15 - 17 - 19 - 22 mm

1/4" + 1/2"

911.0649



405,00

i  **130**
 Ostale informacije



911.0630

1/4" + 1/2"



9 x 1,5 - 2 - 2,5 - 3 - 4 - 5 - 6
8 - 10 mm

9 x TS10 - TS15 - TS20 - TS25
TS27 - TS30 - TS40 - TS45
TS50



1/4" 4 - 4,5 - 5 - 5,5 - 6 - 7
8 - 9 - 10 - 11 - 12
13 mm

1/2" 10 - 11 - 12 - 13 - 14
15 - 16 - 17 - 18 - 19
21 - 22 - 24 - 27 - 30
32 mm

11 x 8 - 9 - 10 - 11 - 12
13 - 14 - 16 - 17 - 19
22 mm



467,00

UZBUDLJIVO I MOĆNO!

i  **128**
 Ostale informacije



911.0628

1/4" + 1/2"



1/4" 4 - 4,5 - 5 - 5,5 - 6 - 7 - 8
9 - 10 - 11 - 12 - 13 mm

1/2" 10 - 11 - 12 - 13 - 14 - 15
16 - 17 - 18 - 19 - 21 - 22 mm

10 x 8 - 10 - 11 - 12 - 13 - 14
15 - 17 - 19 - 22 mm



405,00



Ostale informacije

OMOGUĆAVA MOBILNOST!

1/4" + 1/2"



1/4"		4 - 5 - 6 - 7 - 8 - 9 - 11 12 - 13 mm
1/2"		10 - 11 - 12 - 13 - 14 - 15 - 16 17 - 18 - 19 - 21 - 22 - 24 mm
10 x		8 - 9 - 10 - 11 - 12 - 13 14 - 16 - 17 - 18 - 19 mm

540,00

911.0735



Ostale informacije

TOP SELLER



119,00



9 - 10 - 11 - 12 - 13 - 14 - 15 - 16 - 17 - 18
19 - 20 - 21 - 22 - 23 - 24 - 26 - 27 - 30 mm

9 - 10 - 11 - 12 - 13 - 14 - 15 - 16 - 17 - 18
19 - 20 - 21 - 22 - 23 - 24 - 26 - 27 - 30 mm

1/2"

515.0065

KOMPETENCIJA U KOFERIMA!



i 99
Ostale informacije

**TOP
SELLER**

- 1/4"
- 1/2"



UTIČNI OKASTO-VILIČASTI KLJUČ



- 8 - 9 - 10 - 11 - 12 - 13 - 14
15 - 16 - 17 - 18 - 19 mm

i 99
Ostale informacije

**TOP
SELLER**

- 1/4"
- 1/2"



OKASTO-VILIČASTI KLJUČ



- 8 - 9 - 10 - 11 - 12 - 13 - 14
15 - 16 - 17 - 18 - 19 mm



1/4"	4 - 5 - 6 - 7 - 8 - 9 - 10 - 11 - 12 13 - 14 mm
1/2"	13 - 15 - 17 - 18 - 19 - 20 - 21 - 22 24 - 27 - 30 - 32 mm



**ODLUČITE SE.
UVIJEK DOBAR
IZBOR.**



623,00



540,00

918.0100

918.0200

KALIBRIRANO ZA BUDUĆNOST!



Ostale informacije



Infinitool



isporuka u plastičnom koferu

JEDAN ZA ZAUVIJEK!

SERVICE REMINDER



START 1 6 12 MONTH



KALIBRACIJA POSLIJE 12 MJESECI

Prilikom prve uporabe aktivirajte podsjetnik na servis. Poslije 12 mjeseci automatski ćete dobiti vidljivu crvenu skalu da se vaš moment ključ treba kalibrirati.



od **59,00**

		Nm	Podjela Nm	Lbf-ft		
516.9002		1/4"	1-5	0,02	0,8 - 3,6	59,00 €
516.9012		1/4"	5-25	0,10	0,8 - 18	65,00 €
516.9022		3/8"	10-50	0,10	4 - 37	69,00 €
516.9032		1/2"	20-100	0,10	8 - 75	75,00 €
516.9042		1/2"	20-200	1,00	15 - 150	79,00 €
516.9072		1/2"	60-320	1,00	45 - 236	95,00 €
516.9082		1/2"	80-420	1,00	60 - 310	105,00 €
516.9090		3/4"	110-550	2,00	75 - 405	495,00 €
516.9093		3/4"	150-750	5,00	150 - 550	575,00 €
516.9095		1"	200-1000	5,00	220 - 730	745,00 €



Ostale informacije

SERVICE REMINDER

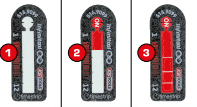

Infinitool

175,00

20-100 Nm

1 X DOŽIVOTNO, MOLIM!



1/2"

516.9110 14 x 18 mm 17 - 22 - 24 - 26 - 27 - 29 mm



Ostale informacije

SERVICE REMINDER



Infinitool

165,00

20-200 Nm

ZAUVIJEK PRECIZNO!



1/2"

516.9105 14 x 18 mm 13 - 15 - 16 - 17 - 18 - 19 - 21 mm

od 20,00

DUGO A B

A	151.4420			<ul style="list-style-type: none"> 1,5 - 2 - 2,5 - 3 - 4 5 - 6 - 8 - 10 mm 	20,00 €
B	151.5210			<ul style="list-style-type: none"> T10 - T15 - T20 T25 - T27 - T30 T40 - T45 - T50 	25,00 €

10,50

TORION power

911.3030

32

Ostale informacije

+30%

1 x		1/4"
1 x		1/4"
4 x		3 - 4 - 5 - 6 mm
4 x		PH1 - 2 x PH2 - PH3
4 x		PZ1 - 2 x PZ2 - PZ3
4 x		3 - 4 - 5 - 6 mm
7 x		T10 - T15 - T20 - T25 - T27 - T30 - T40
7 x		TB10 - TB15 - TB20 - TB25 - TB27 - TB30 - TB40

108

TORION power

Ostale informacije

31,00

918.3108

1/4"

+30%

25 mm		6x: 4 - 5 - 6 mm
25 mm		6x: PZ1 - PZ2 - PZ3
		6x: PH1 - PH2 - PH3
		6x: 4 - 5 - 6 mm
		6x: T10 - T15 - T20 - T25 - T30 - T40

32

TOP SELLER

Ostale informacije

46,00

918.3010

1/4"

-22,1%

-49%

4 x		3 - 4 - 5 - 6 mm
4 x		PH1 - 2 x PH2 - PH3
4 x		PZ1 - 2 x PZ2 - PZ3
4 x		3 - 4 - 5 - 6 mm
7 x		T10 - T15 - T20 - T25 - T27 - T30 - T40
7 x		TB10 - TB15 - TB20 - TB25 - TB27 - TB30 - TB40

208

Ostale informacije

41,00

911.2008

1/4"

1/4"		1/4": 205 mm
138 x		25 mm
29 x		50 mm
18 x		75 mm
20 x		4 - 5 - 6 - 7 - 8 - 9 - 10 - 11 - 12 - 13 mm 5/32" - 3/16" - 7/32" - 1/4" - 9/32" 5/16" - 11/32" - 3/8" - 7/16" - 1/2"
1 x		1/4": 50 mm
1 x		1/4"

NEW

i **1**
Ostale informacije

1/4" 80 mm

5,00

159.1171

NEW

i **1**
Ostale informacije

1/4" 100 mm

7,50

159.1172

od 10,50

1/4"

A	159.2025		6 u 1 Mini ustavljački odvijač	10,50 €
B	159.2035		12 u 1 ustavljački odvijači za bitove	15,00 €

TOP SELLER

6 IN ONE

110 mm **A**

- 4 - 5 mm
- PH1 - PH2
- PZ1 - PZ2

12 IN ONE

240 mm **B**

- 4 - 5 - 6 mm
- PH1 - PH2 - PH3
- 3 - 4 - 5 mm
- T15 - T20 - T25

NEW

i **1**
Ostale informacije

1/4" 80 mm

10,00

159.1176 Dvostruki držač bitova s T drškom

NEW

i **1**
Ostale informacije

1/4" 210 mm

5,00

159.1174 Produžetak za držač bitova

NEW

i **1**
Ostale informacije

200 - 400 mm

1/4" **15,00**

159.1175 teleskopski držač bitova s T drškom

NEW

Četverokutna T drška

od 5,00

A 140 mm

B 300 mm

A	151.1111		1/4" kratko	5,00 €
B	151.1112		1/4" dugo	7,50 €

ERGOTORQUE *plus*

kromiran i ojačan vrh

s oznakom profila na drški

od 10,50

A	159.0005				4 - 5,5 - 6,5 mm PH1 - PH2	10,50 €
B	159.0030				T10 - T15 - T20 T25 - T30 - T40	20,00 €
B	159.0040				TB10 - TB15 - TB20 TB25 - TB30 - TB40	20,00 €

39

TOP SELLER

Ostale informacije

6 x		3 - 4 - 5,5 - 6,5 8 - 10 mm	7 x		2 - 2,5 - 3 - 4 - 5 6 - 8 mm
5 x		PH0 - PH1 - PH2 PH3 - PH4	7 x		TB10 - TB15 - TB20 TB25 - TB27 - TB30 TB40
4 x		PZ0 - PZ1 - PZ2 PZ3	7 x		T10 - T15 - T20 T25 - T27 - T30 T40
1 x		6 mm	1 x		1/4"
1 x		PH2	1 x		205 mm

53,00

159.0100 **1/4"**

13

TOP SELLER

Ostale informacije

oštrica cijelom dužinom

70,00

151.1150 **1/4"**

5 x		3,5 - 5,5 - 7 - 8 - 10 mm
5 x		PH0 - PH1 - PH2 - PH3 - PH4
1 x		6 mm
1 x		PH2
1 x		1/4"

3

NEW

Ostale informacije

EKSTRA DUGO

450 mm

20,00

159.1270

	6 mm
	PH2
	T15

E TO JE ZAKOVICA. DVA GLAVNA DOBITKA.



Zakovica (aluminij)



Zakovica (čelik)



Matica

A	B
150.9805	150.9630

i **15**
Ostale informacije

260 mm

A

70,00

150.9805

i **17**
Ostale informacije

510 mm

B

181,00

3 x
8,5 x 5,5 - 17 x 12 - 19 x 15 mm

5 x
M4 - M5 - M6 - M8 - M10

6 mm

150.9630

	u koferu	✓	✓
	dužina mm	260	510
	grickalica za lim	✓	✗
	rad jednom ili dvije ruke		
	M10	✓	✓
	M8	✓	✓
	M6	✓	✓
	M5	✓	✓
	M4	✓	✓
	M3	✓	✓
	Čelika 4,8 mm	✓	✓
	Čelika 4,0 mm	✓	✓
	Čelika 3,2 mm	✓	✓
	Čelika 2,4 mm	✓	✓
	Aluminija 6,4 mm	✓	✓
	Aluminija 4,8 mm	✓	✓
	Aluminija 4,0 mm	✓	✓
	Aluminija 3,2 mm	✓	✓
	Aluminija 2,4 mm	✓	✓



Ostale informacije

TOČNO I PRECIZNO: SVE JE STVAR STAVA!

NEW



od
10,00

	← →	↻		
115.2017	178 mm	7"	18	10,00 €
115.2018	250 mm	10"	25	15,00 €
115.2019	305 mm	12"	30	17,50 €
115.2021	407 mm	16"	28	27,50 €



Ostale informacije

CrV DIN 5254 A DIN 5254 B DIN 5256 C DIN 5256 D



Ostale informacije



A 19 - 60 mm

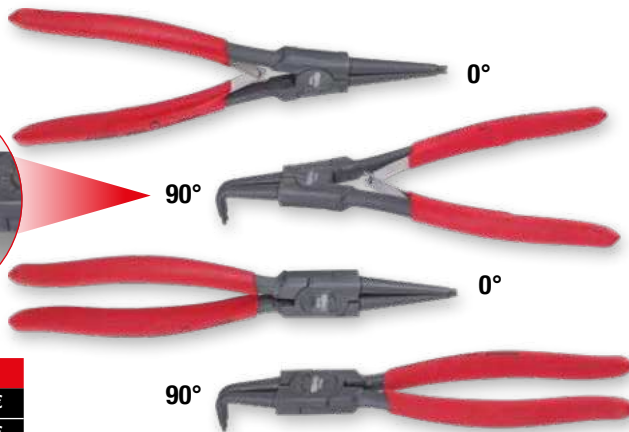

B 40 - 100 mm

od
95,00

	↻	← →	
A	119.2055	19 - 60 mm	160 mm 95,00 €
B	119.2060	40 - 100 mm	230 mm 99,00 €



Ostale informacije

s brzim zaključavanjem

TOP
SELLER



5U1

15,00



550.1145

172 - 640 mm

i **4**
Ostale informacije

10,50

550.1045 45° 135° 0° 90°

i **9**
Ostale informacije

20,00

TOP SELLER

550.1070 45° 135° 0° 90° 45° 90° 0°

i **11**
Ostale informacije

31,00

ISO BUTAN

200 mm

Piezo

20 mm 33 mm Ø 1,6 mm Ø 3,5 mm Ø 4,5 mm Ø 5 mm 30 mm

95 mm 95 mm Ø 40 mm

960.1160 Mikro lemljenje-set

i **283**
Ostale informacije

176,00

220 mm

Ø 0,5 - 6 mm Ø 0,5 - 6 mm Ø 0,5 - 10 mm

Ø 6,50 / 5,41 / 1,72 mm Ø 0,5 - 4 mm

Ø 1,0 - 3,2 mm

115.1400

i **5**
Ostale informacije

regulacija temperature:
1≈50°C / 2≈100°C / 3≈200°C / 4≈350°C / 5≈550°C / 6≈650°C

31,00

260 mm

1 2 3 4 5 6

1 max. 450°C
2 max. 650°C

Područja primjene:
skidanje boje, skupljanje PVCa, zavarivanje i savijanje plastike, sušenja, otapanja itd.

960.1190

i **1**
Ostale informacije

140,00

IP 34

15+1 m

3x 1,5 mm²

230 V
50 Hz

1000/3000 W

10 A

180°

150.4217

i **1**

Ostale informacije

138 x 69
x 31 mm

342

9 V

▶

Data Hold

69 mm

138 mm

20,00

- Mjerenje istosmjernog i izmjeničnog napona
- Mjerenje istosmjerne i izmjenične struje
- Mjerenje otpora
- Kontrola dioda (sa zvučnim signalom)

- Ispitivanje kontinuiteta (sa zvučnim signalom)
- Data-Hold funkcija
- Kontrolni indikator baterije

150.1495

i **1**

Ostale informacije

MULTITALENAT

SAMO JOŠ NE ZNA DA TELEFONIRA.

TOP
SELLER

143 x 70
x 16 mm

119

AAA

▶

Data Hold

NCV

143 mm

70 mm

16 mm

AUTOMATIC
DIGITAL MULTIMETER

Simbol	Opis
	Istosmjerni napon
	Izmjenični napon
	Indikator automatskog isključivanja
	Indikator niske baterije
	Način rada diode
	Prolaz
	Kapacitet
	Omjer mjerača snage
	Funkcija zadržavanja podataka
V, mV	Jedinica za napon: volt, millivolt
mF, µF, nF	Jedinica kapaciteta
MΩ, KΩ, Ω	Jedinica otpora
NCV	Beskontaktna indukcija napona
Live	Testiranje živih vodova
KHz, Hz	Jedinica frekvencije
°C/°F	Celzijus/Fahrenheit

No.	Opis
1	Gumb za napajanje
2	Funkcijski prekidač
3	Kapacitivni prekidač
4	Prekidač za rasvjetu
5	LCD zaslon
6	Područje NCV senzora
7	Ispitni vodi

52,00

USB-A

USB-C

150.1765

i  **1**
Ostale informacije



24,00

300.0510

i  **1**
Ostale informacije



26,00

300.0532

i  **1**
Ostale informacije

**OBOŽAVATE PRECIZNOST:
INFRACRVENI TERMOMETAR,
-38° DO 520°C**



52,00

150.3040

i  **4**
Ostale informacije

59,00



Refraktometar - optički ispitni uređaj za tekućine baterija u sredstvo protiv smrzavanja

550.1290

i  **4**
Ostale informacije

70,00

I ZA ADBLUE®!



Refraktometar - optički kontrolni uređaj za tekućinu u akumulatoru, sredstvo za zaštitu od mraza i AdBlue®-aditivi

550.1285

i  **4**
Ostale informacije

11 x 115 mm
15 x 185 mm
18 x 320 mm
18 x 470 mm

20,00

911.8100 **Metalna poluga-set**

i  **4**
Ostale informacije

XL

900 mm
600 mm

0°
45°
75°
90°

149,00

911.8410 **Metalna poluga-set**

i  **22**
Ostale informacije

Hidraulički univerzalni set skidača, 2+3-kraki

- neznatna opasnost od isklizavanja uslijed automatskog zatvaranja kraka za skidanje
- moguće 8 varijanti skidanja
- iznimno izdržljivo vreteno s induktivno ojačanim navojem
- potrebna neznatna snaga
- specijalni čelik za alate

317,00

700.1200

10 t, AG 1.1/2" x 166

20 - 35 - 85 mm
235 mm
185 mm
225 mm
170 mm
120 mm
Ø max. 100 mm

10t.

NAŠI SETOVI ZA HITNE SLUČAJEVE

i  **13**
Ostale informacije

Rescue power

TOP SELLER

83,00

Uključujući
3/8" 1/2" 3/8"

8 - 9 - 10 - 11 - 12 - 13 - 14 - 15 - 16 - 17 - 18 - 19 mm

i  **7**
Ostale informacije

Rescue power

TOP SELLER

93,00

prsteni 45° koljenasti

6x7 - 8x9 - 10x11 - 12x13 - 14x15 - 16x17 - 18x19 mm



Ostale informacije

17,00

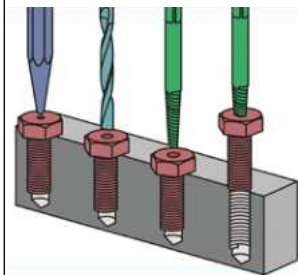

- za vijke M3 - M24
- omogućuje odvijanje pokidanih vijaka i tipli
- kupasta spirala
- u stabilnom plastičnom boku



150.1330 Odvijač za vijke-set



Ostale informacije

S NJIMA NIKADA
NEĆETE POLUDJETI.

TOP
SELLER

TORXION^{power}

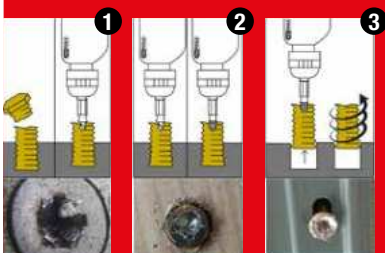

46,00

- 9 x TE10 - TE15 - TE20 - TE25 - TE27 - TE30 - TE40 - TE50 - TE55
- 9 x 1,5 - 2 - 2,5 - 3 - 4 - 5 - 6 - 8 - 10 mm
- 7 x 1,5 - 2 - 2,5 - 3 - 4 - 5 - 6 mm
- 7 x T10 - T15 - T20 - T25 - T27 - T30 - T40



150.7060 1/4" + 10 mm Set odvijača za torx i šesterokutne vijke



Ostale informacije

41,00

- obiman sastav seta
- za uklanjanje slomljenih navojnih tipli i vijaka
- bez oštećenja navoja
- samo neznatno proširenje navojnih tipli preko specijalno profiliranih klinova za odvijanje

Führungshülse drill guide	Hülse Innen- Ø mm guide	vorborehen Ø mm pre-drilling	aufbohren re-drilling	Stift pin	Art.Nr. Stift No. Pin	Mutter D nut D	Art.Nr. Mutter nut D	Stift + Mutter pin + nut
150.0501	4,0 / 3,2	3,2	-	3,2	150.0521	SW 10	150.0511	150.0511S
150.0502	4,8 / 3,2	3,2	-	3,2	150.0521	SW 10	150.0511	150.0511S
150.0503	4,8 / 3,2	3,2	4,8	4,8	150.0522	SW 11	150.0512	150.0512S
150.0504	4,8 / 3,2	3,2	4,8	4,8	150.0522	SW 11	150.0512	150.0512S
150.0505	6,0 / 4,8	4,8	6,4	6,4	150.0523	SW 13	150.0513	150.0513S
150.0506	7,0 / 4,8	4,8	6,4	6,4	150.0523	SW 13	150.0513	150.0513S
150.0507	7,0 / 4,8	4,8	8,0	8,0	150.0524	SW 14	150.0514	150.0514S
150.0508	7,0 / 4,8	4,8	8,7	8,7	150.0525	SW 17	150.0515	150.0515S
150.0509	9,0 / 6,5	6,4	8,7	8,7	150.0525	SW 17	150.0515	150.0515S
150.0510	9,5 / 6,5	6,4	8,7	8,7	150.0525	SW 17	150.0515	150.0515S

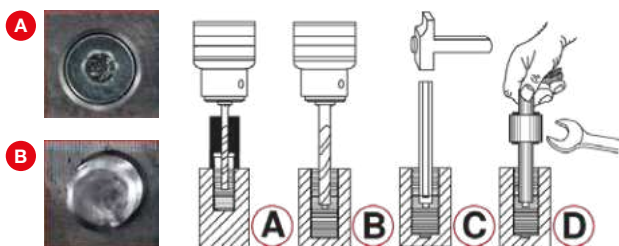

150.1305 M5 - M6 - M8 - M10 - M12 - M14 - M16 Odvijač navoja-set

i **7**
Ostale informacije

52,00

1/2"
21 mm

M5 M6 M7 M8 M10 M12 M14

152.1101 M5 - M6 - M7 - M8 - M10 - M12 - M14 **Alat za odvijanje i vadenje klinova-set**

i **12**
Ostale informacije

26,00

Fino mikro pletivo

	veličina	sadržaj
310.0490	7	12 pari
310.0491	8	12 pari
310.0470	9	12 pari
310.0475	10	12 pari
310.0480	11	12 pari

EN388
4131X

i **100**
Ostale informacije

PERFECT GRIP

od nitrila

SENSITIVE

NEW

8 mil

SVE POD KONTROLOM!
APSOLUTNO OTPORNO NA CIJEPAJNJE,
S EFEKTOM PROTIV ZNOJENJA

20,00

	veličina	sadržaj
310.0461	S	100 Komad
310.0462	M	100 Komad
310.0463	L	100 Komad
310.0464	XL	100 Komad

CE 2777
EN ISO 374-1:2016+A1:2018

S = 80±5 mm
M = 95±10 mm
L = 110±10 mm
XL = 120±10 mm

i **1**
Ostale informacije

NEW

100 mm 160 mm 250 mm

4x U

10,00

Dispanzer rukavica, magnetni

160.0035

i **1**
Ostale informacije

Tehnički podaci:

Izbor boje: bezstupanjski podesivo od DIN 9-13
standardno podešavanje svjetlosti: DIN 4

Vrijeme reakcije prebacivanja: 1/25.000 s
0,2 - 0,8 s odlaganjem (podesivo)

UV/IR zaštita: prema EN169 / do DIN 16

Radna temperatura: -5°C do +55°C

Temperatura skladištenja: -20°C do +70°C

Strujno napajanje: litijska baterija + solarne ćelije

visina: 220 mm

širina: 200 mm

dužina: 295 mm

težina: 480 g

Dimenzije kazete: 100 x 90 x 10 mm

Kontrolni prozor: 100 x 50 mm

52,00

310.0195

i  **1**
Ostale informacije

Univerzalni raspršivač s crpkom za tlak

- od kvalitetnog polietilena
- za različite kemikalije kao npr. sredstva za pranje, otapanje i čišćenje itd.
- ne odgovara za sredstvo za čišćenje kočnica
- glava raspršivača od mesinga, može se podešavati i zatvarati
- brtve od vitona
- odgovara za radove iznad visine glave





! ne odgovara za sredstvo za čišćenje kočnica

150.8251	1 L	15,00 €
150.8252	2 L	20,00 €

od 15,00

i  **1**
Ostale informacije

PRŠTI OD POUZDANOSTI!

TOP SELLER



0,25 L

Aluminium

52,00

150.8272

i  **16**
Ostale informacije



5x	12 mm
5x	16 mm
5x	20 mm



145 mm

13,00

907.2255 **Preklopni strugač-set**

i  **27**
Ostale informacije



5x	12 mm
5x	16 mm
5x	16 mm
5x	20 mm



145 mm

20,00

907.2200 **Nož-strugač-set**

od 11,00

Preklopni nož s blokadom

A	907.2105		1	190 x 25 mm	11,00 €
B	907.2190		1	220 x 28 mm	12,00 €







190 mm

220 mm



Ostale informacije

KONTROLE U HD!

Set Wi-Fi videoscopa s Ø 5,5 mm 0° HD sondom s prednjom kamerom



41,00

HD



6 bijelih mini LED svjetiljki s prigušivačem

Ø 5,5 mm

550.7560



GLAVNI GLUMAC:



KVALITETA SLIKE!

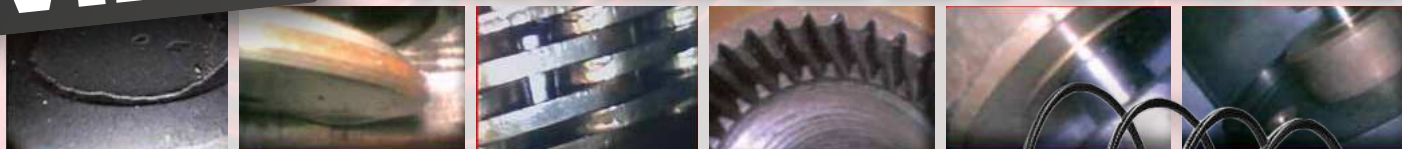

Čahura od oplemenjenog čelika
Navojni priključak za pribor

Krunski dizajn (zaštita + optimalno čišćenje)

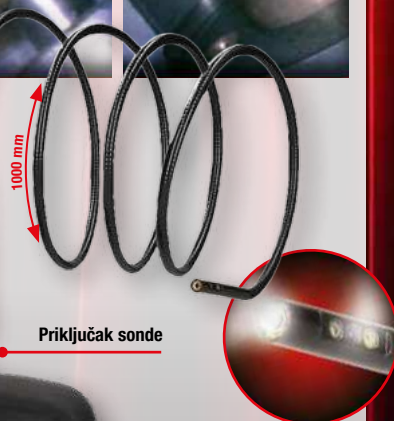
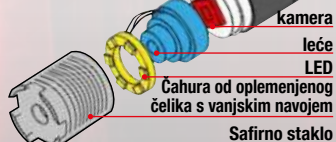

Priključak sonde

HD

311,00



6 bijelih mini LED svjetiljki s prigušivačem

Ø 4,5 mm



1500 mAh Li-polymer

550.7530



Ø 4,5 mm

0° + 90°

311,00 €



magnet



Kuka



Ostale informacije

HD



Ø
3,9 mm

6 bijelih mini LED
svjetiljki s prigušivačem



IP 67

AVI
1280 x 720

JPG

150 mm

-10°/+60°C

**TOP
SELLER**



180°

180°

Priključak sonde



USB 2.0

microSD

3000 mAh
Li-polymer

**ZVIJEZDA U
SVAKOM SETU!**

**DOSTOJAN
OSKARA**

467,00

+ 32 GB

Set HD videoskopa s Ø 3,9 mm 180° i 0° HD sondom
s prednjom kamerom, fleksibilna PVC navlaka

550.7550



113.1500 45° kutna cjevasta kliješta



1 1/2"

270 mm

39,00



104.5060

Steel

Cjevasti rezač s ustavljačkim točkom
Ø 12 - 35 MM

41,00

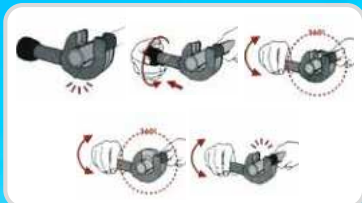

104.5050

Steel

Cjevasti rezač s ustavljačkim točkom
Ø 28 - 67 MM

135,00



116.1050



FUGENFIX set strugača i skidača silikona

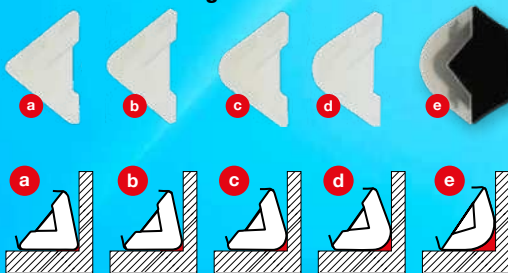

FUGENFIX®



8,00



130.3000

TOP
SELLER

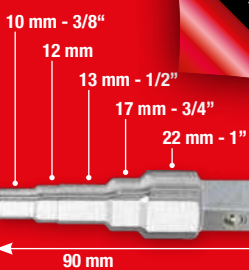

SVAKI
STUPANJ
PUN POGODAK

Univerzalni stepenasti
ključ-set 3/8" - 1"

20,00



116.2000

Alat za fiksiranje
ventila



60,00



130.0300

TOP
SELLER

Set utičnih četverokutnih
ključeva za rashladne i klima
uređaje

111,00



1 x	1/4" - 5/16" - 8,5 - 3/8" 13 mm
10 x	1/4": 3,4 - 4 - 4,5 - 5 - 6,7 - 8 - 9 - 10 mm - 1/4"
3 x	1/4": 7 - 8 - 10 mm
1 x	1/4" 125 mm
1 x	1/4" 150 mm
1 x	1/4" 1/4"





903.5902

Univerzalna lemilica s patronama s Piezo upaljačem

26,00



Piezo



116.2050

Alat za stol za pranje i montažu-set

1 x		M8 / M10
3x		9 x 185 mm - 10 x 185 mm - 13 x 185 mm
1 x		
1 x		3/4"

177,00



116.2030 Kombinirani set glodalica za sanitarije

- odvijanje i zavijanje 1/2" produžetaka za slavine u sanitarnoj završnoj montaži bez problema
- produžeci za slavine se obrađuju glodanjem u ravni sa zidom
- priključni ventili mogu se zategnuti i odviti i u teško pristupačnim područjima
- u stabilnom plastičnom koferu



1 x		1/2"
1 x		12 x 110 mm
1 x		
1 x		



139,00



850.0300 SMARTBAG univerzalna torba za alat



77,00

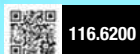

116.6200

35,00

PERFECT 10!

TOP SELLER



Križasti ključ za sanitarije

10 FUNKCIJA

4x unutarnji navoj za stezne vijke M6, M8, M10 + M12 za ugradnju i vađenje pričvrstnih elemenata podloge za pranje

4x vanjski šesterokut 3/8", 1/2", 3/4" + 1" za montažu i demontažu ventila grijnih tijela i navojnica povratnog voda

2x unutarnji četverokut za čepove cijevi 3/8" + 1/2"

Isporuka bez montažnog materijala



Ostale informacije



LED

1/4"

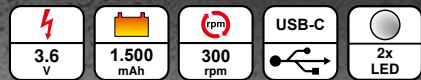

max 6 Nm

max 4 Nm

max 2 Nm



36,00



USB-C



s 25 bitova

515.3600 eMONSTER Aku set bit štapnih odvijača

IZVOLITE: BITOVI U SVOM NAJBOLJEM IZDANJU!

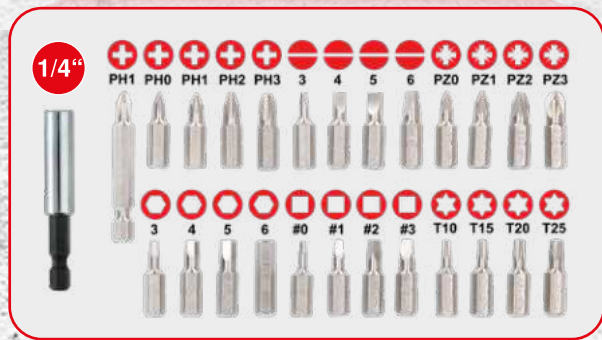

s 25 bitova



Ostale informacije



6 Nm

praktični indikator napunjenosti baterije s 3 LED diode

41,00



2 u 1 uređaj s ujednačenim odnosom između snage i veličine, idealan za rad iznad glave i u tijesnim prostorima.



2 U 1

magnetni prihvat za bitove



1

2

1/4"

predizbor okretnog momenta podesiv u 10 stupnjeva

integrirana svjetiljka



515.6500 eMONSTER set aku bit odvijača





Ostale informacije

515.3990

MULTITALENAT

eMONSTER Set aku multifunkcijskih alata s 50 dijelova pribora

eMONSTER



1 Bušenje

1x Ø 3 mm

2 Čišćenje

1x

3 brušenje

1x Ø 6 mm

4x

23x Ø 20 mm

4 graviranje

1x

1x

1x

1x

5 razdvajanje

8x Ø 24 mm

0,8 mm

6 poliranje

4x Ø 13 mm, Ø 25 mm

politura



52,00

ZA PONOVNU KUPNJU



Ostale informacije



10,50

515.3992 Set pribora, 50-dijelni



Kompaktan I robusan dizajn:

Zahvaljujući visokokvalitetnoj vrsti plastike I čvrstih navojnih spojeva, punjiva baterija je posebno dobro zaštićena od mehaničkih utjecaja.



18V eMONSTER aku sustav

Snažan 18V eMONSTER aku sustav objedinjuje niz profesionalnih akumulatorskih električnih alata. Svi uređaji mogu se koristiti s akumulatorskim sustavom. Asortiman je veoma širok i neprekidno se proširuje. Svaki novi uređaj može se također koristiti s ovim akumulatorskim sustavom. Tako možete godinama koristiti ovaj akumulatorski sustav i proširiti ga s eMONSTER 18V uređajem - ostati ćete u istoj akumulatorskoj porodici.



Odvođenje topline

Zahvaljujući rebrastoj strukturi, toplina se odvodi u okolni zrak poput radijatora



Dotatna zaštita za dug vijek trajanja punjivih baterija:

- **Zaštita od prenapona:**
Zaštita od nedozvoljeno visokih izvora napona
- **Zaštita od niskog napona:**
Zaštita od dubokog pražnjenja tijekom rada
- **Upravljanje temperaturom:**
Interakcija između uređaja I baterije radi sprječavanja preopterećenja punjive baterije



Aktivno hlađenje zrakom:

(samo u slučaju 8.0 Ah brzih punjača) Integrirani ventilator brzog punjača 8.0 Ah neprekidno tijekom postupka punjenja osigurava svjež zrak kako bi se najbolje moguće smanjila nastala toplota. Zahvaljujući ovom posebnom postupku punjenja povećava se vijek trajanja akumulatora.



Optimiziran raspored ćelija:

Struktura cijevi pojedinačne ćelije gura u plastiku koja odvodi toplotu. Tako nastaje jak kontakt između ćelije i plastike koja odvodi toplotu. Više nema izolacijskog sloja zraka koji smanjuje odvođenje toplote.



Ostale informacije

1/4" TORSIONpower set bitova u eMONSTER aku dizajnu, 32-dijelni



10,50

1 x		1/4"
1 x		1/4"
4 x		3 - 4 - 5 - 6 mm
4 x		PH1 - 2 x PH2 - PH3
4 x		PZ1 - 2 x PZ2 - PZ3
4 x		3 - 4 - 5 - 6 mm
7 x		T10 - T15 - T20 - T25 - T27 - T30 - T40
7 x		TB10 - TB15 - TB20 - TB25 - TB27 - TB30 - TB40



može se priključiti i aretirati na 18V eMONSTER uređaje kao aku imitacija

TOP
SELLEReMONSTER Brushless set
akumulatorskih bušilica/odvijačaeMONSTER Brushless set
akumulatorskih udarnih bušilica/
odvijačaTOP
SELLER

MINI

166,⁰⁰Obrtni moment maks.: 40 Nm
pogon: 10 mm stezna glava
za brzo otpuštanje

515.6400

UKLJUČUJUĆI

napon baterije: 18,0 V
Aku tehnologija: Litijski
Kapacitet baterije: 2,0 Ahisporuka s dvije baterije 2,0 Ah i
brzim punjačem od 3 A

UKLJUČUJUĆI

197,⁰⁰Obrtni moment maks.: 60 Nm
pogon: 13 mm Röhm metalna
brzopotezna stezna glava

515.6300

TOP
SELLEReMONSTER 1/2" Brushless
set akumulatorskih
udarnih ključevaeMONSTER Brushless
set akumulatorske
kutne brusiliceTOP
SELLER280,⁰⁰Maks. okretni moment
nepričvršćeno: 690 Nm
pogon: 1/2"

515.6100

UKLJUČUJUĆI

napon baterije: 18,0 V
Aku tehnologija: Litijski
Kapacitet baterije: 4,0 Ahisporuka s dvije baterije 4,0 Ah i
brzim punjačem 8 A311,⁰⁰broj okretaja: 9000 o/min
Ubrzanje vibracija:
< 4,831 m/s²
3,371 m/s²

515.6200



Ostale informacije

s fiksno ugrađenom
prebacivom 4-strukom
letvom s utičnicama za
šuko utikače i 2 USB-A
utičnice149,⁰⁰nudi prostor za kvačenje 4
eMONSTER 18V uređaja

515.6901

eMONSTER ormar za alat za zidnu montažu

1.390 N·m

1/2"

96 mm

185 mm

515.1150

1

207,00

1.390 N·m

1/2"

95 mm

190 mm

515.1270

2

155,00

1.084 N·m

1/2"

115 mm

180 mm

515.1315

3

72,00

1.600 N·m

1/2"

170 mm

185 mm

515.1200

4

72,00

SNAŽNI ARGUMENTI!

2.000 N·m

3/4"

170 mm

185 mm

515.3400

5

130,00

1.690 N·m

1/2" 3/4"

175 mm

200 mm

515.1210

6

155,00

515.3785

7

197,00

3.405 N·m

3/4" 1"

40 mm

350 mm

230 mm

515.3250

9

883,00

515.3270

11

883,00

3.405 N·m

3/4" 1"

195 mm

350 mm

230 mm

515.3260

10

940,00

515.3280

12

940,00

		Nm	U/min	m/s ²	dB(A)	dB(A)	U/min	PT				Kg	
1	515.1150	1/2"	1390	10.000	<9,18	102,0	113,0	135	1/4"	-	✓	-	1,08
2	515.1270	1/2"	1390	10.000	<9,18	102,0	113,0	135	1/4"	-	✓	-	1,3
3	515.1315	1/2"	1084	9000	<10,36	106,0	115,0	169	1/4"	-	✓	-	1,2
4	515.1200	1/2"	1600	8500	<17,5	89,9	100,9	169	1/4"	✓	-	-	2,1
5	515.3400	3/4"	2000	8500	<17,25	91,0	100,9	196	1/4"	✓	-	-	2,2
6	515.1210	1/2"	1690	7930	<17,9	87,0	98,0	178	1/4"	✓	-	-	2,1
7	515.3785	3/4"	1690	7930	<13,56	88,0	104,0	178	1/4"	✓	-	-	2,2
8	512.0002	1/2"	2300	8500	<8,69	99,7	110,9	244	1/4"	✓	-	✓	1,6
9	515.3250	3/4"	3405	6200	<12,57	115,5	104,5	283	1/2"	✓	-	-	6,7
10	515.3260	3/4"	3405	6200	<12,88	115,5	104,5	283	1/2"	✓	-	-	7,7
11	515.3270	1"	3405	6200	<12,57	115,5	104,5	283	1/2"	✓	-	-	6,7
12	515.3280	1"	3405	6200	<12,88	115,5	104,5	283	1/2"	✓	-	-	7,8

udarni mehanizam s dva čekića visokih performansi

Jumbo udarni mehanizam velike snage

BITURBO tehnologija



ROCKET II
2300
VB BITURBO



BITURBO

**S BI-TURBO PUNIH 2.300 NM
ZA SAMO ~ 15 SEKUNDI!**

512.0002

8



145,00

VB 8 UMJESTO 6 LOPATICA ROTORA

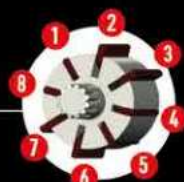

PROMIŠLJENO ODVOĐENJE ISPUŠNOG ZRAKA



**max.
2.300
Nm**

**SAMO!
1,6 KG**

1/4" PT	8.500 rpm	max. 2300 Nm	max. 851 Nm	max. 1256 Nm	244 L/min	6,3 bar	3,8" - 10,0 mm	1,6 kg	<8,69 m/s ²	110,9 dbA	99,7 dbA	max. M 16
---------	-----------	--------------	-------------	--------------	-----------	---------	----------------	--------	------------------------	-----------	----------	-----------

2. GENERACIJA: JOŠ JAČA, JOŠ SNAŽNIJA, JOŠ BOLJA!

3u1 univerzalna sigurnosna spojnica za komprimirani zrak **NEW**

Ostale informacije

UNIVERZALNO - JEDAN ZA SVE

15,00

999.9101	A	9 mm	15,00 €
999.9102	A	11 mm	15,00 €
999.9103	A	14,5 mm	15,00 €
999.9104	B	1/4" AG	15,00 €
999.9105	C	1/4" IG	15,00 €

20,00

510 mm
330 mm
95 mm

3

Ostale informacije

515.1921 Pneumatski pištolj za ispuhivanje-set

i  
Ostale informacije

IZDRŽLJIVA ČELIČNA VARIJANTA

NEW

179,00

Ø 10 MM X 20 M

Tehnički podaci:

maks. tlak:	12 bar
Dužina crijeva:	20 + 1 m
Unutarnji promjer crijeva:	10 mm
Priključni navoj:	3/8"
Dozvoljena Područje Temperature:	-40 - 60 °C

515.3425 **Namatač za pneumatsko crijevo**

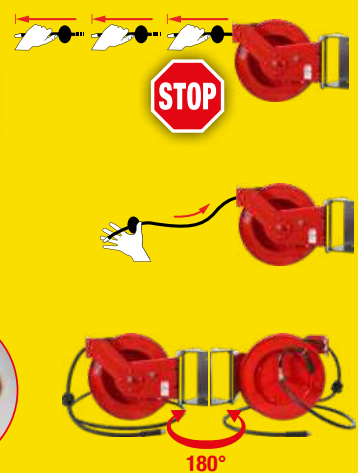

Automatski namatač za pneumatsko crijevo

i  
Ostale informacije

124,00

515.3440

A **Ø 10 MM X 15 M**

Tehnički podaci:

maks. tlak:	20,0 bar
Dužina crijeva:	15 + 1,5 m
Unutarnji promjer crijeva:	10,0 mm
Priključni navoj:	1/4"

i  
Ostale informacije

187,00

515.3445

B **Ø 13 MM X 15 M**

Tehnički podaci:

maks. tlak:	20,0 bar
Dužina crijeva:	15 + 1,5 m
Unutarnji promjer crijeva:	13,0 mm
Priključni navoj:	3/8"



i  
Ostale informacije

- 3** 5000 rpm, 57 dB, 4,9 m/s, 56,9 W
- 2** 4500 rpm, 51,5 dB, 4,3 m/s, 53 W
- 1** 4000 rpm, 48 dB, 3,5 m/s, 49 W

- 
- 
- 

52,00

**EKSTREMNO TIH
ULTRA LAGAN
< 3,5 KG**

999.2000 **Ventilator za radionice, 70 vati**

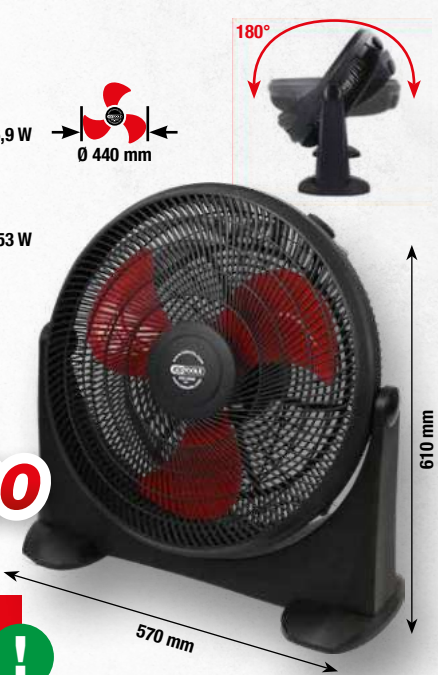

i  
Ostale informacije

Paralelna stega

**TOP
SELLER**

**S NJIM MOŽETE ZATEGNUTI
I PODIĆI SVOJE STANDARDE!**

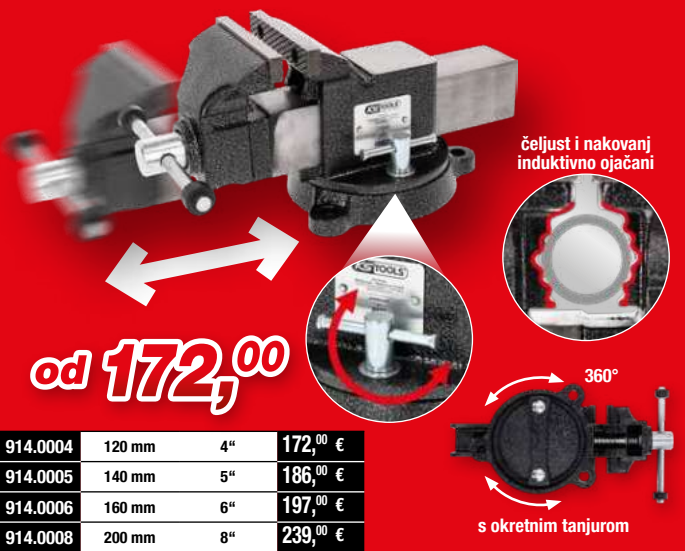

od 172,00

914.0004	120 mm	4"	172,00 €
914.0005	140 mm	5"	186,00 €
914.0006	160 mm	6"	197,00 €
914.0008	200 mm	8"	239,00 €

čeljust i nakovanj induktivno ojačani

s okretnim tanjurom

1

Ostale informacije

480 mm
320 mm
36 mm
1.150 mm
36 mm
550 mm

A **B** **od**

A	500.8040	480 mm	12,00 €
B	500.8045	1.150 mm	41,00 €

12,00

1

Ostale informacije

420 - 540 mm

62,00

500.8030

OVDJE STE UVIJEK NA PRAVOM MJESTU!

2

Ostale informacije

85 mm
400 mm
1.040 mm

72,00

500.8011

3

Ostale informacije

420 mm
145 mm
1.200 mm
510 mm
145 mm

104,00

500.8000

	1	2	3	4
Tehnički podaci:	500.8030	500.8011	500.8000	500.8090
boja	crveno	crveno	crveno	crveno
Materijal	metal	metal	metal	plastika
broj upravljačkih kotača	5	6	6	6
može se kretati na kotačima	✓	✓	✓	✓
vrsta guma	plastika	plastika	plastika	plastika
postavljeno	✓	✓	✓	✗
podesivo po visini	✓	✓	✓	✗
sadržaj pakiranja	1	1	1	1
ukupna dužina D u mm	370,0 mm	1040,0 mm	1200,0 mm	1030,0 mm
širina B	370,0 mm	490,0 mm	420,0 mm	480,0 mm
visina H	420,0 - 540,0 mm	85,0 - 400,0 mm	145,0 - 510,0 mm	115,0 mm
ukupna nosivost kg	90 kg	90 kg	90 kg	120 kg

4

Ostale informacije

115 mm
480 mm
1.030 mm

70,00

500.8090

i **3**
Ostale informacije

Genijalno fleksibilno

46,00

500.8077 Set za odlaganje alata, od silikona

53 x 29,5 x 3,2 cm

25,5 x 23,3 x 2,4 cm 27,5 x 14,5 x 2,4 cm

JEDNOSTAVNA ORGANIZACIJA

i **38**
Ostale informacije

po 12 podesivih držača za nasadne ključeve
1/4", 3/8" i 1/2"

12 x 1/4"
12 x 1/2"
12 x 3/8"

30 x 15,5 cm

15,00

800.0185 Magnetni sustav za čuvanje nasadnih ključeva

NEW

i **1**
Ostale informacije

Magnetna prostirka

320 mm

100 mm

245 mm

od 10,00

800.0180 100 mm 10,00 €
800.0175 245 mm 20,00 €

NEW

i **1**
Ostale informacije

10-18 kg

Ø 72 mm

10 - 18 kg

10,00

800.0165 Magnetni držači

NEW



ZA POZICIJU VIŠE!

od **35,00**

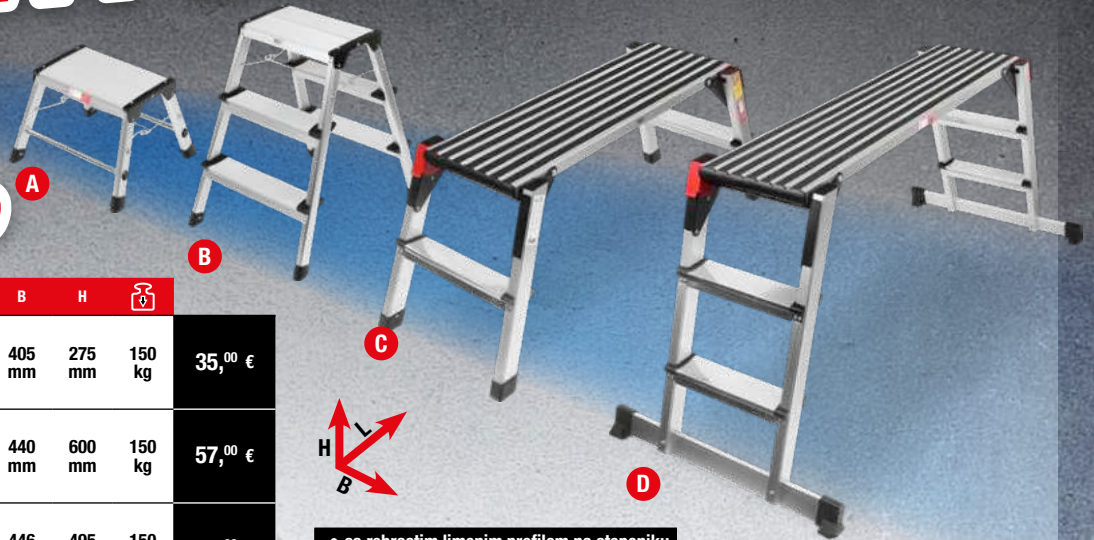

			L	B	H	📦		
A	800.0975			380 mm	405 mm	275 mm	150 kg	35,00 €
B	800.0965			620 mm	440 mm	600 mm	150 kg	57,00 €
C	800.0960			1270 mm	446 mm	495 mm	150 kg	104,00 €
D	800.0985			1650 mm	380 mm	730 mm	150 kg	139,00 €

- sa rebrastim limenim profilom na stepeniku
- bez naginjanja uslijed ukrivo postavljenih nogara
- pristup s dvije strane
- preklopiva te se stoga mogu skladištiti uz uštedu prostora
- plastični rubovi na stopama štite pokretnu platformu i pod

Ostale informacije

max. 80 kg

54,00

140.2226

Ostale informacije

max. 100 kg

187,00

500.8100

Ostale informacije

max. 400 kg

1246,00

865.0201

XXL radni stol s 3 ladice i 1 vratima

i 1
Ostale informacije

max. 3-7 h ↘ 2,5 h IP45

GIGANTSKI MALO, SNAŽNO SVJETLO!

114 mm

MAX. 500 LUMENA

70 Lumena

19,00

UltimateBEAM Aluminijska LED kontrolna lampa, litij-jonska, 500 lumena

150.4530

NEW

USB C

U

AL

i 1
Ostale informacije

max. 2-4,5 h

↘ 1,5 h IP20

KOMPAKTNO I IZDRŽLJIVO

160 mm

150 Lumena

20,00

UltimateBEAM aluminijska LED olovka lampa, litij-jonska, 150 lumena

150.4540

NEW

i 1
Ostale informacije

max. 3 h ↘ 3 h IP20

s laserskim pokazivačem

MAX. 350 Lumena

165 mm

17,00

može se puniti preko USB-C kabela (priložen)

LED COB Stripe kontrolna svjetiljka 350 lumena s UV spot LED i laserski pokazivač

150.4400

i 1
Ostale informacije

25 m max. 10 h IPX3

85 Lumena

15,00

140 mm

25 m

perfectLight džepna svjetiljka 85 lumena

150.4370

Modi	COB 100%	COB 40%	COB rot	XPE 100%	XPE 40%
LED	270° 3 Watt COB LED			1 Watt High Power XPE LED	
40% 100%	350 LM	150 LM	-	100 LM	40 LM
	3 h	6 h	8 h	4 h	8 h

i 1
Ostale informacije

senzorski prekidač On/Off

USB-C

Power Display

150.4520

senzor pokreta

MAX. 100 Lumena

MAX. 350 Lumena

270°

ON OFF

podešavanje veličine

XPE LED 2 stupnja osvjetljenja

COB LED 3 stupnja osvjetljenja

15,00

40 - 350 Lumen ↘ 4,5 h

max. 8 h IPX4 95 g

TOP SELLER

18,00

TOP SELLER

250 Lumena

500 Lumena

USB

ON OFF

180°

1200 mAh litij ionska akumulatorska baterija (priložena)

3x AAA baterije (nisu priložene)

s USB Power Bank funkcijom

150.4510

20 %	●
40 %	●●
60 %	●●●
80 %	●●●●
100 %	●●●●●

max. 3 h

3 h

IP65

20,00

130 Lumena

300 Lumena

USB-A OUT

USB-C IN

ON OFF

Powerbank funkcija

integrirana litij ionska akumulatorska baterija 1.200 mAh

150.4505

20 %	●
40 %	●●
60 %	●●●
80 %	●●●●
100 %	●●●●●

max. 3 h

3 h

IP65

17,00

60 Lumena

150 Lumena

Micro USB

ON OFF

360°

180°

150.4495

20 %	●
40 %	●●
60 %	●●●
80 %	●●●●
100 %	●●●●●

max. 3,5 h

2,5 h

IP20

39,00

250 Lumena

550 Lumena

USB-A OUT

USB-C IN

360°

150.4490

20 %	●
40 %	●●
60 %	●●●
80 %	●●●●
100 %	●●●●●

max. 3,5 h

3 h

IP65

Nema upletenih kabela!

Sada još brže punjenje bez kabela!



ULTIMATE BEAM BY KSTOOLS



MAX. 100 Lumen

Ø 16,6 mm

573 mm

Za podizne platforme ili radionički ormar

Za zidnu montažu

169,5 mm

100 mm

169,5x100x14,15 mm

max. 20W

150.4611 Podloga za punjenje s dvije točke za punjenje **30,00**

1x 20W ✓

1x 40W ✓

2x +

4x + + + +

* u obimu isporuke nije sadržan mrežni dio ili kabel za punjenje.

MAX. 100-1000 Lumen

MAX. 90-850 Lumen

MAX. 170 Lumen

MAX. 110-1100 Lumen

3 IN 1

max. 3,7-9 h

573x Ø30 mm

138x Ø35 mm

max. 3,4-9 h

138x Ø35 mm

249x Ø35 mm

max. 2,6-8 h

max. 7,8 h

249x Ø35 mm

249 mm

180°

90°

80,00

4-DIJELNI

150.4600 3 u 1 Quick-Lock set radnih svjetala, 4-dijelni

MAX. 170 Lumen

MAX. 110-1100 Lumen

150.4610 Ručna lampa **49,00**

max. 2,5-6,5 h

max. 7,25 h

IP54 IK07

257x 55x37 mm

90°

MAX. 100 Lumen

MAX. 100/200 Lumen

MAX. 100 Lumen

max. 4/2,3 h

max. 2,8 h

IP54 IK06

165x 22x15,7 mm

165x 22x15,7 mm

Clip

max. 5,3/8 h

max. 4 h

IP54 IK06

155x 22x15,7 mm

365 nm

UV

LED

25,00

25,00

150.4640 Kontrolna lampa

150.4641 UV lampa za pretragu 365 nm



Tehnologija



100%



MAX. 100 Lumen
MAX. 350/450 Lumen
 69 mm
2 IN 1

150.4625 2u1 lampa za glavu/ radno svjetlo **35,00**

MAX. 20-180 Lumen
MAX. 20-180 Lumen može se skidati
 251 mm
2 IN 1

150.4630 2 u 1 vratna lampa s dvije radne svjetiljke koje se mogu skidati **42,50**

MAX. 140 Lumen
MAX. 50-600 Lumen
 133 mm
 90°

150.4615 Ručna lampa kompaktna **42,50**

MAX. 90 Lumen
MAX. 150/350 Lumen
 180 mm

150.4620 Ručna lampa tanka **27,50**

MAX. 130-1300 Lumen
 96 mm
 90°

150.4635 mini radno svjetlo **42,50**

Artikl	prebaciva jačina svjetlosti	kontinuirano dimabilna	maks. lumen reflektora	maks. lumen reflektora	boja svjetla (Kelvin)	maksimalno trajanje glavne svjetiljke (h)	maksimalno trajanje reflektora (h)	težina baterije (g)	Zaštita od prakanja vode	razred otpornosti na udar	Dimenzije (DxŠxV) u mm	težina neto (g)	maks. vrijeme punjenja s kablom (h)	maks. vrijeme punjenja s poslodavca (h)
150.4610	✓	✓	110-1100	170	6000	2,5-6,5	7,25	50,71	IP54	IK07	257x55x37	320		
150.4615	✓	✓	50-600	140	6000	3,75-12	9,5	39	IP54	IK07	133x62,6x26	185	3	4,7
150.4620	✓	✗	150/350	90	6000	3,8/2	7,6	18,8	IP54	IK07	180x31x17,4	75	2	2,25
150.4625	✓	✗	350/ 450	100	6000	2,4/ 3,5	6	22	IP54	IK07	69x32x44			
150.4630	✓	✓	2x 20-180	/	6000	/	2	12	IP54	IK07	251x137x49	225	1,7	2,5
150.4635	✓	✓	130-1300	/	6000	3,6-7,2	/	73,45	IP54	IK07	96x65x40,5	300	4,2	9,35
150.4640	✓	✗	100/ 200	100	6000	4/2,3	2,8	10,69	IP54	IK06	165x22x15,7	56,5	1,85	2,8
150.4641	✓	✗	/	/	365nm	5,3/8	4	10,69	IP54	IK06	165x22x15,7	56,5	1,85	2,8
150.4600	✓	✓	/	/	/	/	/	50,71	IP54	IK07	/	585	3,6	4,9
150.4601	✓	/	/	/	/	/	/	50,71	IP54	IK07	156,5x51x36,5	220	/	/
150.4602	✓	✓	110-1100	170	6000	2,6-8	7,6	/	IP54	IK07	249x035	90	3,6	4,9
150.4603	✓	✓	100-1000	100	6000	3,7-9	10,6	/	IP54	IK07	573x030	120	3,6	4,9
150.4604	✓	✓	90-850	/	6000	3,4-9	/	/	IP54	IK07	138x035	155	3,6	4,9
150.4611	/	/	/	/	/	/	/	/	IP20	IK07	169,5x100x14,15	220	/	/

i

Ostale informacije

 max. 8 bar (116 PSI)	 60° C 140° F
-----------------------------	---------------------

20,00

1 Water Max. 40° C

2 Detergent Max.

3

4

5 Switch

Lock

150.8271 **Pneumatski crpni raspršivač pjene (pjenilica)**

i

Ostale informacije

OPUSTI SE!

88,00

350 mm

650 mm

www.kstools.com
500.8013

500.8013 **Pokretna stoličica**

i

Ostale informacije

 6,3 bar	 96 L/min
 92 dbA	 1/4" PT

41,00

145 mm

3/8" - Ø 10 mm

www.kstools.com
515.5090

usisavanje

puhanje

515.5090 **Pneumatski usisno-ispušni pištolj**

i  **1**
Ostale informacije

Ø 88 mm

5/16" x 24F

15 mm

7,50

NEW

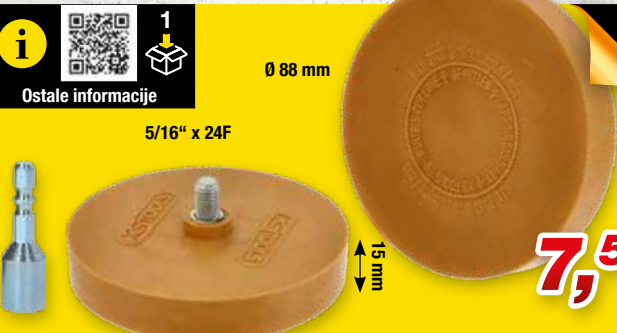

515.5481 **Brisač folije**

i  **1**
Ostale informacije

Ø 88 mm

5/16" x 24F

15 mm

10,00

NEW

ZA MATIRANE LAKOVE



515.5491 **Okrugla gumica za matirane lakove**

i  **10**
Ostale informacije

60,00

CIJENA PO SETU = 10X

515.5486



i  **10**
Ostale informacije

80,00

CIJENA PO SETU = 10X

515.5496



i  **1**
Ostale informacije





300 mm

245 mm

ON - OFF

može se regulirati

Industrijski kuglični ležajevi

360°

30°

147,00

		
		<3.90 m/s icon" data-bbox="445 905 475 935"/>
		

515.1980 **Pneumatski pištolj za ispuhivanje**

i  **1**
Ostale informacije



NEW



DOBRO NAORUŽANI!

150 mm

Ø 43 mm

105 mm

360°

30°

40,00

515.5595 **Pneumatski pištolj za čišćenje**

i  **23**
Ostale informacije

ODRŽAVATI PRECIZNO RASTOJANJE

NEW

 Ø 10,2 mm

 M8 x 50 mm

 1x 17/19 mm  1x 18/20 mm  1x 18,2/22,5 mm

 1x 26,7/24 mm  1x 26/32 mm  1x 29,3/27 mm  1x 38,9/28,1 mm

49,00



140.2650 **Alat za rupe-set za odстойne senzore (PDC)**

i  **6**
Ostale informacije

31,00

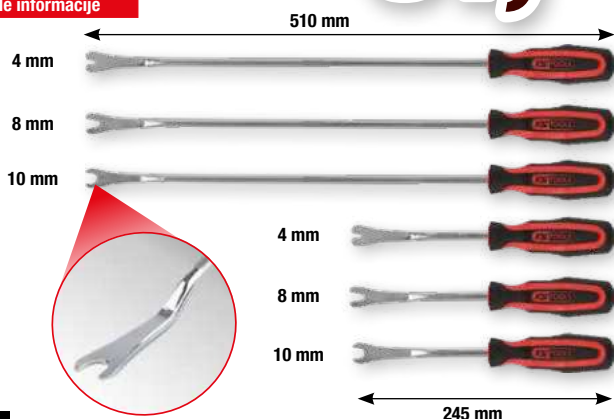

140.2370 **Set za odvijanje stezaljki**



i  **11**
Ostale informacije

20,00

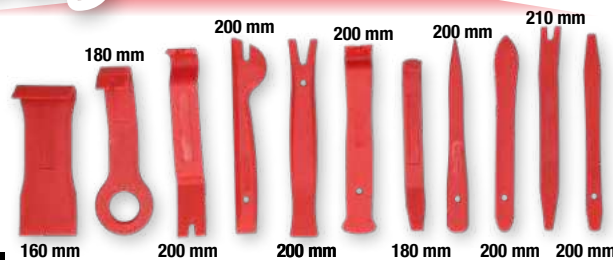

911.8205 **MASTER plastični klin-set**



i  **303**
Ostale informacije

NEW

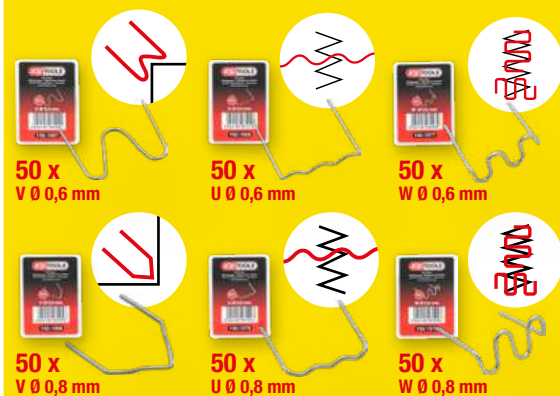

i
punjenje aku baterije dovoljno za oko 400 stezaljki za popravke



98,00

MAX. 600°C

DC 5V 2A 600°C max

3,7 V 30 W 4.000 mAh 3 h ≈400x

i **VOLVO** **NEW**

Ostale informacije

38,00

Alat za podešavanje senzora radara za Volvo

140.2152

i **VOLVO** **NEW**

Ostale informacije

50,00

Alat za podešavanje kamere za pomoć pri parkiranju za Volvo

140.2153

i **TESLA** **NEW**

Ostale informacije

za demontažu gornjeg poklopca stražnje svjetiljke

9,00

Specijalni alat za demontažu stražnjeg svijetla za Tesla model 3

10 3/8"

150.8101

i **NEW**

Ostale informacije

630 mm

250 mm

Ø 3 - 43 mm

80,00

Univerzalni Stezna kliješta za crijeva s bowden sajлом

115.0908

i **NEW**

Ostale informacije

180 mm

25 mm

Ø 0 - 30 mm

32,00

Kliješta za crijevne obujmice sa samozaključavanjem

115.0907

i **7**

Ostale informacije

BEZ UMARANJA!

83,00

Ø 0 - 38 mm 1

Ø 0 - 48,5 mm 4

Ø 0 - 30 mm 2

Ø 0 - 45 mm 5

Ø 0 - 65 mm 3

Ø 0 - 45 mm 6

Ø 0 - 60 mm 7

115.1055 Kliješta za obujmice za crijeva za teretna vozila-set



Ostale informacije

DRUGI TRAŽE. VI PRONALAZITE!

NEW

Tehnički podaci:

Strujno napajanje: 12 V DC (baterija vozila) ili KS Tools eMONSTER akumulatorska baterija
 snaga dima: 20 - 30 ml/min
 trajanje primjene: 10 - 25 min (s 10 - 20 ml ulja)
 vrijeme hlađenja: 10 - 20 min

1 eMONSTER s 2,0 Ah akumulatorskom baterijom

2 ili sa stezaljkom za baterije

349,00

eMONSTER

OPTIONAL

Dimno ulje

250 ml

10,00

550.1483

Stroj za maglu, sa 2 Ah akumulatorske baterije

550.1470

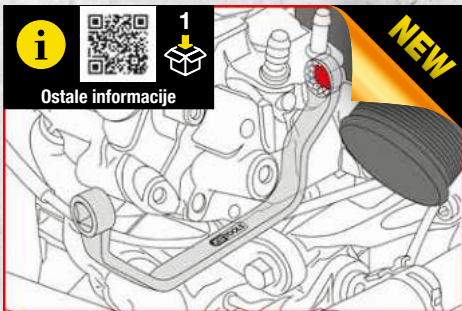

NEW



Ostale informacije

13 mm

166 mm

12,00

3/8"

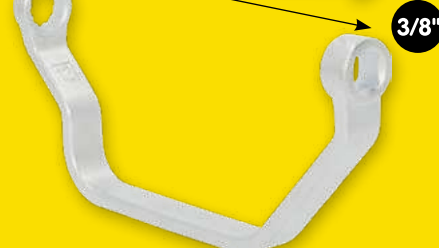

specijalni utični ključ za navojne spojeve usisne cijevi, VAG

150.2518

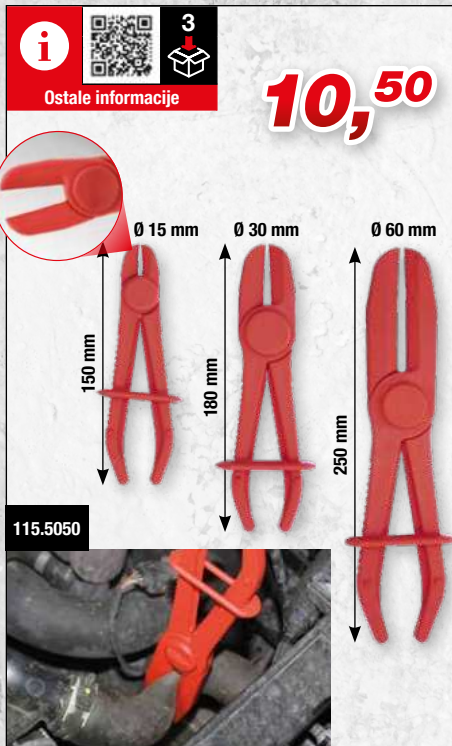

Ostale informacije

10,50

Ø 15 mm

Ø 30 mm

Ø 60 mm

150 mm

180 mm

250 mm

115.5050



Ostale informacije

13,00

Ø 35 mm

Ø 15 mm

Ø 23 mm

155 mm

255 mm

165 mm

115.5055

i  

Ostale informacije



15,00

Ručna pumpa za izvlačenje i punjenje

150.9221 

i  

Ostale informacije

15,00 **NEW**



27 mm

Ø 60 mm

AUDI E-TRON

Specijalni utični ključ za demontažu spremnika rashladnog sredstva za Audi

150.1924

i  

Ostale informacije



1/2"

108 mm

13,00

Alat za skidanje poklopca hladnjaka za VAG

150.1919

i  

Ostale informacije



12,0 V

20,00

Električna crpka za usisavanje i transfer ulja

150.2820

i  

Ostale informacije

Spojka 7,2 mm na 4,4 mm



7,2 mm

80 mm

4,4 mm

20,00

150.1936

i  

Ostale informacije

Spojka 4,4 mm na 7,2 mm



4,4 mm

74 mm

7,2 mm

26,00

150.1937

i  

Ostale informacije

max. 76 cm

0 - 200 °C
0 - 400 °F

1600 mm

187,00

R123 R124 R123 R125 #1 #2 #3 M50 x 2,5 M42 x 3 M58 x 3 M62 x 3 M48 x 4 M45 x 3 M50 x 2,5 M60 x 4 M52 x 3 M48 x 2,5 M42 x 2,5 M50 x 3 M46 x 3 M34 x 2,5 75 mm

MASTER rashladni sustavi-dijagnostika-servis-set

150.1930

i  **8**
Ostale informacije

250 ml

KS TOOLS

REACTIÖNLIÖSUNGSMITTEL
REACIÖN FLUID
LIQUID REACTANT
LIQUIDO DE REACIÖN
LIQUID REAGENT
REAGENTSÜBSTANCE
DOPŁYNKIENIA
REACTIVFLÜSSIGKEIT FÜR VERBUNDUNGSREAGENT

150.1914

NEOBAVEZAN

15,00

150.1914

104,00

150.1910 CO2-test curenja glave cilindra-set



i  **4**
Ostale informacije

NEW

SVAKA ISKRA SE RAČUNA!

97 mm

3/8"

39,00

14 mm 16 mm 18 mm 21 mm

14 mm 16 mm 18 mm 21 mm

set nasadnih ključeva za svjeće, magnetni sa zglobom

517.1145 3/8" 14 - 16 - 18 - 21 mm



i  **2**
Ostale informacije

FORD ECOBOOST

14 mm

180 mm

ZA FORD ECOBOOST MOTORE 1,0 LITARA

+

16 mm

215 mm

26,00

ZA FORD ECOBOOST MOTORE 1,5 LITARA

Set nasadnih ključeva za svjeće za EcoBoost motore

517.1135 3/8" 16 - 21 mm





Ostale informacije

- za naknadno urezivanje zahrđalih i oštećenih navoja sonde
- idealno za NOX osjetnike i osjetnike filtara za čestice na ispušnim sustavima
- Sa 6 reznih rubova za idealno centriranje
- posebno kratka varijanta
- s žlijebom za čišćenje u vodici

187,00

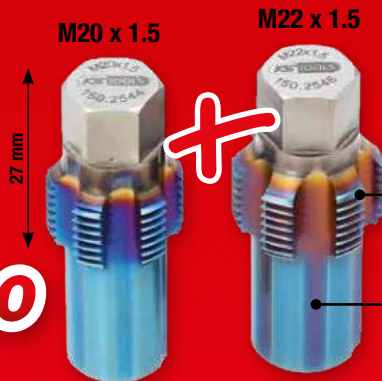

Sa 6 reznih rubova za idealno centriranje

s žlijebom za čišćenje u vodici

150.2540 Set urezivača navoja s vodicom za osjetnike



DA UVIJEK ODREŽETE DOBAR KOMAD!



Ostale informacije

Rezač navoja sa vodicom

- za naknadno urezivanje zahrđalih i oštećenih navoja sonde



L1 L2



Sa 6 reznih rubova za idealno centriranje

s žlijebom za čišćenje u vodici

104,00

A	150.2541	za senzore temperature	M12 x 1,25	55 mm	33 mm	13 mm	104,00 €
B	150.2542	za senzore temperature	M14 x 1,5	45 mm	30 mm	13 mm	104,00 €
C	150.2543	za lambda sonde	M18 x 1,5	42 mm	27 mm	13 mm	104,00 €
D	150.2544	za NOX senzore	M20 x 1,5	50 mm	27 mm	13 mm	104,00 €
E	150.2546	za senzore filtra za čestice	M22 x 1,5	50 mm	27 mm	13 mm	104,00 €

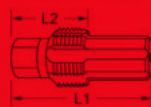

Ostale informacije



176,00

150.1900 Tlačne i podtlačne pumpe, set



Ostale informacije



52,00

Univerzalni montažni alat za brtveni prsten osovine i zaštitni prsten-set

700.1280

i 2
Ostale informacije

NEW

T50

15,00

24 mm

17 mm

1/2" 24 mm

Područja primjene: Ford dizel motori 2.0L EcoBlue, 2.0L Duratorq TDCi (DW10F)

150.3270 Set kombiniranih ključeva za alternator, Ford

i 1
Ostale informacije

1/4" 13 mm

- Za zatezanje i otpuštanje remenice zupčastog remena
- podesivo, univerzalno primjenjivo
- unutarnji četverokutni pogon prema DIN 3120 / ISO 1174
- s vanjskim šestierokutnim pogonom 13,0 mm
- fosfatiziran

0,3,0 mm

8 - 25 mm

20,00

Univerzalni ključ za remenice natežača zupčastog remena, podesiv

150.3046

i 1
Ostale informacije

10,50

120 mm

Područja primjene: Citroën, Peugeot, Opel i Toyotas 1,0 i 1,2 benzinskim motorima (šifra motora: ZMZ (EBOF / EBO) / HM01 (1PP) / HMV, HMZ (EB2) / HMZ (EB2 / EB2F) / HMT (EB2D) / HMU (EB2D) / HNZ (EB2DT) / HNY (EB2DTS) / HMV (EB2M) / HMY (EB2M) / B12XE (EB2F) / D12XE (EB2FA) / B12XHL (EB2DT) / D12XHL, F12XHL (EB2ADT) / B12XHT (EB2DTS) / D12XHT, F12XHT (EB2ADTS))

400.2118 Alat za ispitivanje zupčastog remena za PSA

i 7
Ostale informacije

2 U 1

NEW

90 mm

220 mm M14 x 1,5

27 mm 15 mm

Ø 50 mm Ø 47 mm

225,00

- za montažu i demontažu zupčanika koljenastog vratila
- odgovara i za montažu prednjeg brtvenog prstena koljenastog vratila
- s alatom za držanje sklopa koljenastog vratila
- vrlo visoka preciznost

Područja primjene: Audi A1 (8X), A3 (P), Seat Altea (5P), Leon (1P), Ibiza IV (6J, 6P), Toledo IV (KG), Skoda Fabia II (542,545), Oktavia II (1Z), Rapid (NH1, NH3), Roomster (5J), Yeti (5L), Volkswagen Golf VI (5K, AJ,517), Golf Plus (5M,521), Polo V (6R, 6C), Jetta VI (162, 163, AV), Caddy III (2K, 2C), Beetle (5C), Touran (1T) šifra motora: 2.0L TSI / TFSI (CBZA, CBZB, CBZC)

400.0910 Set alata za montažu zupčanika za VAG

VW 1,2 TSI

NEW

i **1**
Ostale informacije

BRZO I SIGURNO!

39,00

140 mm
45 mm

115.0909 **Alat za otključavanje s okretnom glavom za brze spojnice**

NEW

i **1**
Ostale informacije

25,00

270 mm
65 mm

115.0906 **Kliješta za vodove goriva za brze spojnice**

NEW

i **1**
Ostale informacije

29,00

6 mm
56 mm

115.1102 **Alat za otključavanje vodova goriva za BMW i Mini**

i **22**
Ostale informacije

Petrol **Diesel** **OIL**

- za montažu i demontažu CLIC opružnih zatvarača-spojnice vodova koji se teško otvaraju, na vodovima za gorivo, vodovima za klima uređaje, pneumatskim i hidrauličnim vodovima
- bez oštećenja utičnih spojnica, vodova goriva i crijeva za gorivo
- brzo i jednostavno razdvajanje vodova goriva
- za skoro sve spojnice vodova na evropskim, azijskim i američkim vozilima

52,00

115.1260 **Set alata za otključavanje spojnica vodova**



Ostale informacije

LAKO SKIDANJE PRI 3.873 UDARA PO MINUTI!

TOP
SELLER

- s 7 prilagodnika za skoro sve ubrizgivače
- izuzetno visok udarni efekt za skoro sve ubrizgivače (3365 (6,3 bar) / 3873 (8 bar) udara u minutu)
- za rastavljanje zapečenih injektora u glavi cilindra
- s odgovarajućim prilagodnikom izvlakač se uvijek na zapetku mlaznicu za ubrizgavanje
- neznatna potreba prostora uslijed kompaktne građe



A B C



D



E F G H



223 L/min	3/4"-19 mm	108,4 dbA
6,3 bar (90 psi)	71,9 m/s ²	6 mm
max 12 bar	119,4 dbA	M18 x 1,5

A	M25 x 1,0	Siemens
B	M20 x 1,0	Denso
C	M27 x 1,0	Siemens
D	M27/M17/10 mm	Bosch/Fiat/BMW/PSA/Mercedes/ Renault
E	M18 x 1,5	Prilagodnik
F	M17 x 1,0	Bosch/Mercedes
G	M16 x 1,0	Toyota
H	M14 x 1,5	Bosch/Delphi/BMW



280,00

**BOSCH
DENSO
DELPHI
SIEMENS**



Set pneumatskih alata
za izvlačenje injektora

152.1130

6
Ostale informacije

285 - 875 mm
150 - 675 mm
TELESKOPSKI

500g
200g
1000g
2000g
3000g

Ø 4 mm
Ø 13 mm
Ø 16 mm
Ø 19 mm

400 mm
510 mm

28,00

550.1090 Set fleksibilnih i teleskopskih držača magneta i kontrolnih ogledala

1
Ostale informacije

50 mm
180 mm
30/23 mm
4 mm

NEW

25,00

115.1108 Rastavna klijesta za električne priključke

1
Ostale informacije

125 mm

6 - 24 V
5,00

550.1504 Ispitna svjetiljka 6 - 24 V

2
Ostale informacije

62,00

1 Prijemnik
2 Odašiljač s krokodil klemama

150.3075 Detektor kratkog spoja

1
Ostale informacije

140 mm
12,00

3 - 48 V

550.1503 Ispitivač polariteta i napona 3 - 48 V

i **1** Područja primjene: Audi e-tron GT (< 2021), Porsche Taycan (< 2021)

Ostale informacije

51 mm

NEW

Alat za otpuštanje komunikacijskog konektora na modulu baterije HV baterije za Audi i Porsche

150.1366 **7,50**

i **1** Ostale informacije

16 mm

63 mm

NEW

Bit nasadni ključ, unutarnji šesterokut za HV pričvršćenja baterije za VAG

150.1301 **7,50**

i **1** Ostale informacije

148,00

za cjevaste kableske papučiće 10 do 120 mm²

570 mm

NEW

Kliješta za stezanje terminala baterija

115.1410

i **25** Ostale informacije

Silikon max. 24V (10A) Ø 4 mm

MERLJIVO BOLJE!

NEW

Ø 4,0 mm → 2,0 mm 175 mm

Ø 4 mm 1100 mm

Ø 4 mm 140 mm

Ø 4 mm 80 mm

Ø 4 mm 160 mm

Ø 4 mm 47 mm

Ø 4,0 mm → 2,0 mm 175 mm

Ø 4 mm 85 mm

Ø 4 mm 105 mm

Ø 4 mm 155 mm

12/24V kablovi za dijagnozu, ispitivanje i mjerenje-set

150.0895 **45,00**

i **1** Ostale informacije

382,00

Za skoro sve baterije

S pisačem i 3 role papira

START A STOP

Tehnički podaci:

Indikator:	digitalno
Radno područje CA / MCA:	40-2.000 CCA
Radno područje CCA:	40-2.000 CCA
Radno područje DIN:	40-2.000 CCA
Radno područje EN:	40-2.000 CCA
Radno područje IEC:	40-2.000 CCA
Radno područje JIS#:	40-2.000 CCA
Radno područje SAE:	40-2.000 CCA
Radna temperatura:	0°C do +55°C
Područje frekvencije:	100 Hz
Mjerno područje:	9-36 V
Preciznost mjerenja:	+/- 0,5 Megaohm
Područje napona:	9-36 V

12 V / 24 V digitalni tester za sustave baterija i punjača sa integriranim pisačem

550.1649



Ostale informacije

623,00



12 V pojačavač za baterije - mobilan pomoćni startni uređaj 1400 A

550.1720

-
-
-
-
- 12/24 V
- 1400 A
- PEAK AMP 4400 A
-
-
- 1,6 m 35 mm
- 2x22 Ah



1.400 A

SAFETY Xtreme



Inteligentan sigurnosni koncept sprječava korisničke greške:

sigurnosni prekidač šalje struju na stezajfke tek:

- kada je korektno priključena (polovi)
- kada je priključak osiguran od kratkog spoja
- kada postoji ispravan napon
- kada je baterija vozila ispravna



Ostale informacije

APSOLUTNO BRZ UDARAC!

NEW



- 192 x 92 x 61 mm
- 430 g
- 9 V
-
- Data Hold



- V~ ▶ 6 V - 750 V
- A~ ▶ 60 mA - 20 A
- V... ▶ 600 mV - 1000 V
- A... ▶ 60 mA - 20 A
- Ω ▶ 600 Ω - 60 MΩ
- F ▶ 600 mA/1000V (32x6 mm)
- ▶ 20 A/1000 V (38x10 mm)

115,00

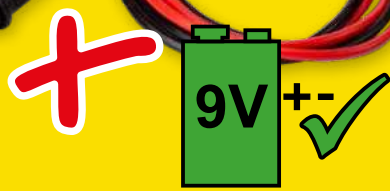

117.0215

Digitalni multimeter s ispitnim vrhom s integriranom zaštitom od udara



Ostale informacije



< 44.500 V



sa zidnim držačem

1.680 mm

187,00

MOŽE SPASITI ŽIVOT!

Isolirana šipka za spašavanje

150.0913



Ostale informacije



3/8"

Set alata s izoliranim alatima za hibridna i električna vozila

117.1895

343,00

2 x		4 mm - 5,5 mm
2 x		PH1 - PH2
6 x		6 - 8 - 10 - 12 - 13 - 17 mm
1 x		185 mm
1 x		165 mm
1 x		3/8"
1 x		3/8": 200 mm
1 x		3/8": 125 mm
10 x		3/8": 8 - 10 - 11 - 12 - 13 - 14 - 16 - 17 - 19 - 22 mm
1 x		200 mm



Ostale informacije



1000 V

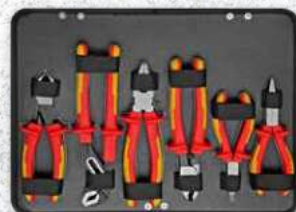

3/8"

587,00

Set alata s izoliranim alatima za hibridna i električna vozila

117.1890

4 x		2,5 - 3 - 3,5 - 4 mm
3 x		PH1 - PH2 - PH3
3 x		T20 - T25 - T30
1 x		210 mm
1 x		185 mm
1 x		165 mm
1 x		215 mm
1 x		165 mm
1 x		240 mm
2 x		10 - 25 mm
1 x		180 mm
1 x		3/8"
15 x		3/8": 6 - 7 - 8 - 9 - 10 - 11 - 12 - 13 - 14 - 16 - 17 - 18 - 19 - 20 - 22 mm
2 x		3/8": 150 - 250 mm
3 x		3/8": M8 - M10 - M12
1 x		Ø 200 mm
1 x		200 mm
1 x		500 m



Ostale informacije



s 4 dužna žlijeba, 3 prihvaća za kaiš i integriranom kasetom za kaiš s viskoznom kočnicom



99,00

Stup za sigurnosni pojas

117.1555



Zidni držač za sigurnosni pojas

117.1556



Ostale informacije

VAŠ ULAZAK U ELEKTRIČNU MOBILNOST



Kvadratne perforacije za dijelove pribora



može se zaključiti pomoću ugrađene cilindrične brave



radna ploča s pjenastom podlogom debljine 10 mm



sa samouvlačenjem i SOFT-CLOSE funkcijom



2 x kočnice kotrljanja i okretanja Ø kotača: 125 mm

ecoLine



1

⊖ 2,5 - 4 - 5,5 mm ⊕ PH0 - PH1 - PH2



2

3/8" 8-18 mm 1/2" 10-24 mm 125+250 mm
125+250 mm 4-5-6-8-10 mm
3/8"+1/2"



117.0222



117.0223

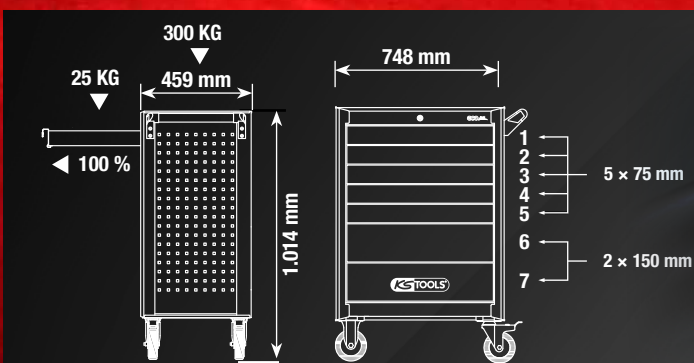

1349,00

S 42 ALATA

117.6144

ECOline radionička kolica s 42 izolirana alata za hibridna i električna vozila



Ostale informacije

performance plus €10

4466,00



Hibrid blic ploča s upozorenjem



200 mm

917.3898



117.6172 3/8" +1/2" set izoliranih utičnih ključeva s moment ključem u ulošku od pjene, 72-dijelni

Hibrid prekidač ploča s upozorenjem



Ø 200 mm

917.3897



117.6133 Set izoliranih ključeva u ulošku od pjene, 33-dijelni

Izolaciona prostirka, 1000 mm, debljina 3,0 mm



117.3819

Donje rukavice, 260mm



117.1660

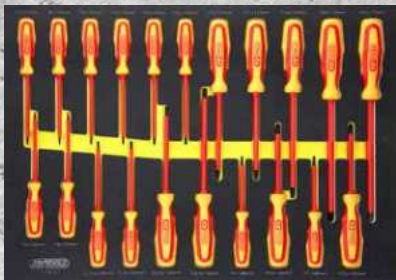

117.6121 ERGOTORQUE VDE set odvijača u ulošku od pjene, 21-dijelni

Električarske zaštitne rukavice sa zaštitnom izolacijom, veličina 10, debljina 1, bele



117.1664

Zaštita za lice za električare, klasa 2



117.1796



117.6117 ERGOTORQUE VDE set kliješta u ulošku od pjene, 17-dijelni

117.6155 PERFORMANCEplus radionička kolica e10 s 164 izolirana alata za hibridna i električna vozila

10,50



117.0223

Krovni stalak sa simbolom munje i magnetom

NAJOPSEŽNIJI U SVOJOJ KLASI



10,50

117.0222

Krovni stalak sa simbolom munje i vakuumskim držačem



15,00

117.0226

Stalak sa simbolom munje



Katalog za elektromobilnost s 188 stranica možete vidjeti na www.kstools.com

145,00

117.1545

2 x Ograda od plastike

2x

72,00

117.1550

Set stupova za ograđivanje s lancem

4x

i  **4**
Ostale informacije

Ø 22,0 - 28,0 mm

Ø 15,0 - 21,0 mm

Ø 17,0 - 25,0 mm

Alat za centriranje spojke-set

150.2180 Ø 15,0 - 28,0 mm

9,00



i  **11**
Ostale informacije

150 kg

310 mm

450 mm

300 mm

160.0910 Set univerzalnih nosača prijenosnika

410,00



i  **1**
Ostale informacije

NEW

34 mm

1/4"

150.9699 Posebni nasadni ključ za ventil za zadržavanje preostalog tlaka na prigušivaču zračne opruge

10,00

AUDI, PORSCHE, VW



160.0910 Set univerzalnih nosača prijenosnika



i  **24**
Ostale informacije

PUNJENJE SA SUSTAVOM

150.9261		1/8-27 NPT Ford
150.9262		BMW, Honda, Nissan etc.
150.9263		VAG
150.9264		VAG, Porsche
150.9265		M10 x 1.0 VAG, Mini Cooper
150.9267		M12 x 1.5 Mercedes
150.9268		M24 x 1.5 VAG DSG
150.9269		M22 x 1.5 VAG CVT
150.9271		M18 x 1.5 Skoda
150.9272		M30 x 1.5 VAG, Skoda
150.9273		Universal Flexible 300 mm, Honda, Hyundai, Kia, etc.
150.9274		5/16-24 (UNF) Volvo
150.9276		M18 x 1,5 Toyota / Lexus
150.9277		M8 x 1,0 Nissan / Infinity
150.9278		ATF-Adapter V.W, Passat
150.9562		Nissan Juke M12 x 1,25
150.9563		Mini Cooper M14 x 1,5
150.9564		issan M10 x 1,5
150.9566		GM M12 x 1,75
150.9567		Mercedes 725-9G
150.9102		VAG 7 DSG
150.9103		VAG 7 DSG
150.9104		VAG 7 DSG

207,00

SA SETOM ADAPTERA OD 23 DIJELA

150.9105 Univerzalni sustav za punjenje ulja u prijenosnik sa 23-dijelnim setom prilagodnika





Ostale informacije



PUMPE SA SNAGOM

69,00

NEW

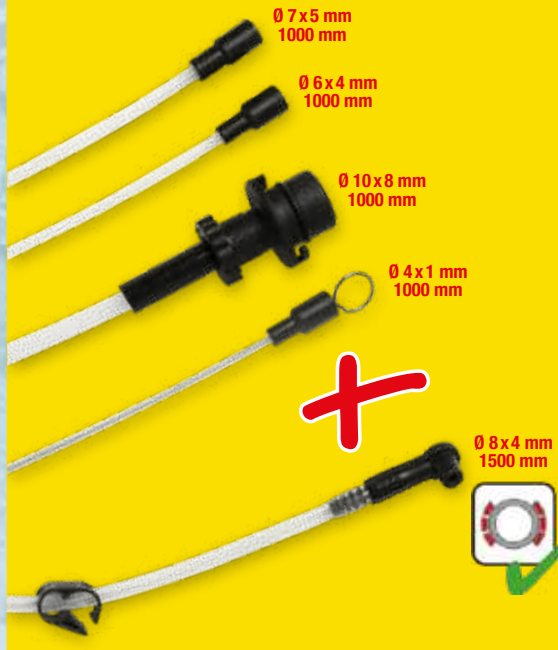

- idealno za čisto, brzo i jednostavno odsisavanje, usisavanje i pražnjenje tekućine
- odgovara za motorno ulje, ulje za prijenosnike, hidraulično ulje, kočiona tekućina, voda itd.
- za pneumatsku primjenu s kompresorom ili manualnu s integriranom ručnom crpkom
- postupak usisavanja se automatski prekida kada je kućište puno, te nema prelijevanja tekućine
- s integriranim ventilom za nadtlak za više sigurnosti



160.0865 Vakuumska odsisna crpka s posudom od 6,5 litri



Ostale informacije



NEW

OBLIK: XS FUNKCIJA: XL



7,50

150.9597 Nasadni ključ za montažu amortizera za Tesla



Ostale informacije

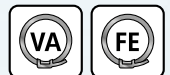

41,00

115.1056 Kliješta za crijeva za zatezanje okretnim momentom

i  **4**
Ostale informacije



116,00

\emptyset 30 mm

McPherson držači amortizera za dizalicu prijenosnika

160.0195

i  **7**
Ostale informacije



6 mm

104,00

Specijalni pomoćni montažni alat za amortizere-set za amortizere sa vučnom oprugom sa graničnikom



1
2
3
4

150.9545



TESTIRANO ZA VAŠU SIGURNOST!

i  **6**
Ostale informacije

i

univerzalan za 90% svih uobičajenih opruga za vozila u putničkom i transportnom području

\emptyset 80 - 160 mm

\emptyset 140 - 195 mm

469,00

- idealan za sigurnu montažu i demontažu Mc Pherson držača opruge
- potrebno za zamjenu amortizera ili opružnih vijaka
- univerzalan za 90% svih uobičajenih opruga za vozila u putničkom i transportnom području
- povoljna i solidna alternativa uobičajenim zatezačima opruga
- odgovara i za kupaste i kuglične opruge
- s TÜV dozvolom



Tehnički podaci:

Kapacitet opruge:	2600 kg
Zatezna širina maks.:	355,0
tlak opruge maks.:	80,0 - 195,0 mm

500.8400 Univerzalni zatezač opruga-set



Ostale informacije



TESTIRANO ZA VAŠU SIGURNOST!

Ø 30 mm

1/2" x 1/2", 100 Nm

Ø 90 - 140 mm

387,00

500.8765 Audi i Seat set teleskopskih centriranih zatezača za unutarnje opruge

ZA PROŠIRENJE



Ostale informacije

ZA ZATEZAČ OPRUGA 500.8755 + 500.8765

Ø 95-110 mm

104,00

Područja primjene:
MercedesE klasa (W211 / W212), C klasa (W204), GLA (X156), GLK (X204), Ford Focus II (MK2), BMW1 (E81), Volkswagen Passat (B8 / 3G)

500.8770 Par držača opruga, Ø 95-110 mm

ZA PROŠIRENJE



Ostale informacije



Ø 30 mm

Ø 90 - 140 mm

Ø 75 - 115 mm

352,00

WARNING - ACHTUNG - ADVARSEL
ADVERTENCIA - AVERTISSEMENT

500.8755 Univerzalni teleskopski centrirani zatezač-set za unutarnje opruge

LAKO ZATEZANJE

i  **1**
Ostale informacije

max 12000 N



1190,00

500.8800 Pneumatski zatezač opruga, maks. 10 bara

i  **1**
Ostale informacije

max 24000 N



s dvostrukim cilindrom

1660,00

Razina komprimiranog zraka u zatezaču opruge s dvostrukim cilindrom

500.8810

ZA 95% SVIH VOZILA

i  **1**
Ostale informacije

- jednostavno rukovanje
- specijalni čelik za alate
- idealno za prihvat opruga
- optimalno za sigurno stajanje prilikom montaže i demontaže
- s 4 fiksna klina i 4 navojna klina
- isporučuje se s 2 uskočnika za montažu

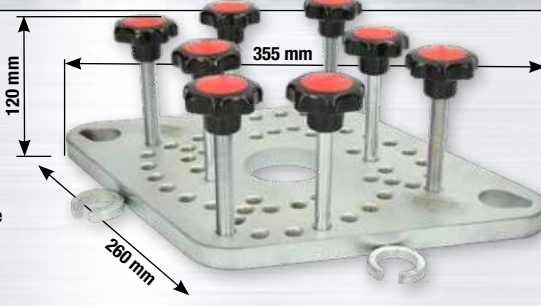

293,00

500.8801 Prilagodnik ploča za pneumatski zatezač opruge

SET OPRUŽNIH ZATEZAČA S PRILAGODLJIVOM PLOČOM

i  **2**
Ostale informacije

Opružni zatezač za mjerenja komprimiranog zraka s prilagodnik-pločom



1400,00

500.8805

i  **2**
Ostale informacije

zatezač opruge razine komprimiranog zraka s dvostrukim cilindrom i prilagodnom pločom



1869,00

500.8815

i **1**
Ostale informacije

max. 8 bar

450 mm

1/4" PT

za univerzalne manžete osovina

104,00

515.3100 Pneumatski montažni uređaj za manžete osovina

i **1**
Ostale informacije

100 mm

Ø 30 mm

255 mm

52,00

150.1850 Univerzalni skidač zglobov vratila

i **1**
Ostale informacije

41,00

Alat za proširenje rupa na stezaljki

700.5662

10 mm

UNIVERSAL

5 - 14 mm

max. 25 Nm

i **6**
Ostale informacije

384,00

515.3880 Vibro-Power pneumatsko čekić dlijeto-set

110 mm

10 mm

110 mm

10 mm

130 mm

10 mm

100 x 25 x 12 mm

10 mm

37x / sec.



Ostale informacije

TOP
SELLER



175,00

700.1495 Univerzalna poluga osovine s lancem

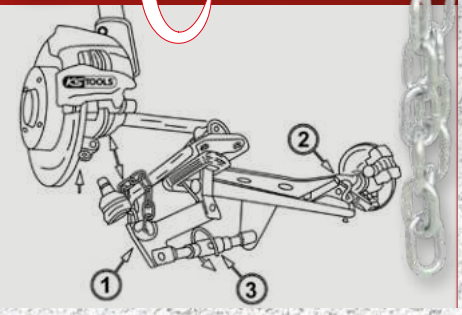

- fleksibilan lanac omogućuje sigurno potiskivanje poprečnih upravljača različitih modela bez velikog napora



Ostale informacije

NEW

- stabilno trapezno navojno vreteno
- nožna pedala za fino podešavanje (20mm)
- idealan pomoćnik u radionici u brojnim situacijama

150,00

max. 680 kg



1365 - 2050 mm



performance
Teleskopski
podložni potpornik

420 mm

	maks. nosivost t	min. visina mm	maks. visina mm	dužina mm	širina mm
160.1265	0,68	1365,0	2050,0	420,0	85,0



Ostale informacije



93,00

911.6187 Teleskopska metalna poluga s okretnom glavom



Ostale informacije

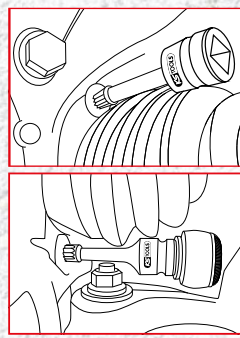

M12

115 mm

72 mm

Specijalan teretni bit-nasadni ključ-set za zupčaste (XZN®) vijke

20,00

515.0595 1/2"



Ostale informacije

S BRZIM ZAKLJUČAVANJEM



1000 WATT



750 mm

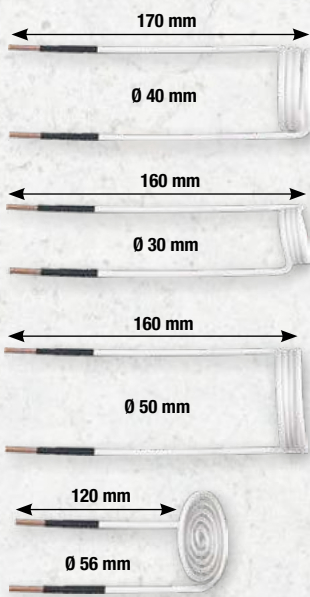

469,00

OPTIONAL 500.8605

100 x 100 mm



135,00

500.8440

500.8605 Induktivni grijni pištolj-set



Ostale informacije



1500 WATT

549,00



NEW

NEKI TO VOLE VRUĆE!



770 mm



230 mm

Ø 28/60 mm

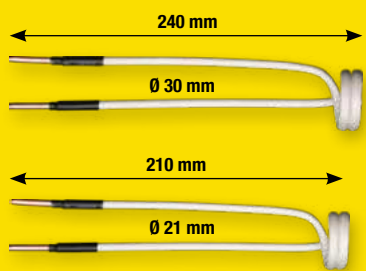

240 mm

Ø 30 mm

210 mm

Ø 21 mm



OPTIONAL 500.8680

57,50



800 mm

Indukcijski kalem s keramičkom zaštitom, fleksibilan

500.8687

500.8680 Induktivni grijni pištolj-set



Ostale informacije



311,00

TOP
SELLER



4 x



M10x1,5 - M12x2,0
M14x2,0 - M16x2,5

9 x



Ø 38 - 40 - 42 - 50 - 52
54 - 62 - 64 - 66 mm

13 x



Ø 34 - 36 - 44 - 46
48 - 56 - 58 - 60 - 68
70 - 72 - 75 - 80 mm

1 x



Ø1: 34 - 80 mm



Ø2: 44 - 90 mm



2 x



700.1550

Potisne i vučne čahure-set



Ostale informacije



30-35 mm

35-40 mm

40-45 mm



1/2" / 32 mm

360 mm



83,00

150.1125

Specijalni ključ za aksijalni zglob-set



Ostale informacije

4,3
Kg

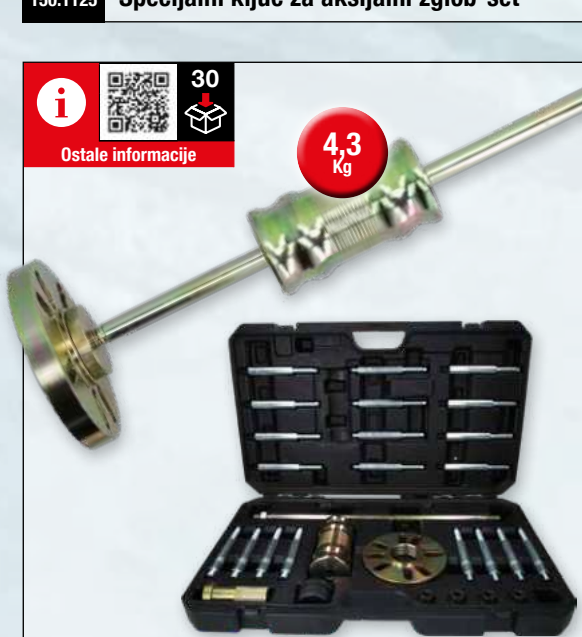

1 x

Ø 90 - 130 mm



3

4

5

1 x

4 x M 14

4 x

4 x

4 x

M12 x 1,25
M12 x 1,5

M12 x 1,25
M12 x 1,5
M14 x 1,5

M18 x 2,5 x 230 mm

M57 x 2

1 x



233,00

700.1530

Set univerzalnih skidača glavina kotača i zglobnih osovina

**DONESITE ZAISTA DOBRU ODLUKU PRILIKOM ZAMJENE STAKALA:
MANJE RADNE SNAGE, VISE PROFITA!**

ONE-MAN-SHOW PRILIKOM ZAMJENE STAKALA



**ONE MAN
CUT**

Set profesionalnih
zaštitnih tabli, 4-dijelni

2x 270x200 mm + 2x 450x300 mm

Fiksator žice za rezanje

Visokokvalitetan
crpni usisivač

6-kutni pogon, 30 mm

Otpusna ručica

Usisna snaga:
110 kg

Sonda za uvođenje žice
za rezanje, 290mm

Povratni valjak

Usisna snaga:
110 kg

Vakuumski tanjur
Ø 150 mm

Fiksator žice za rezanje

Vakuumski
tanjur Ø 50 mm

Vakuumski tanjur
Ø 50 mm

4-rubna žica, 50 m

Usisna snaga: 110 kg

Povratni valjak

najlon, 50 m



Ostale informacije



13



Zaštitna tabla, pod kutom

- idealno za profesionalno i pažljivo vadenje zalijepljenih vjetrobrana, te većine bočnih i stražnjih stakala
- s velikom skretnicom čime se smanjuje potrebna snaga i minimizira opasnost od kidanja žice

- vođenje neposredno ispred ploče, na taj način u većini slučajeva nije potrebna komplicirana demontaža tapeciranih mjesta
- lako rukovanje za koje je dovoljna jedna osoba
- posebno kvalitetna crpna usisna jedinica za sigurno držanje na staklu

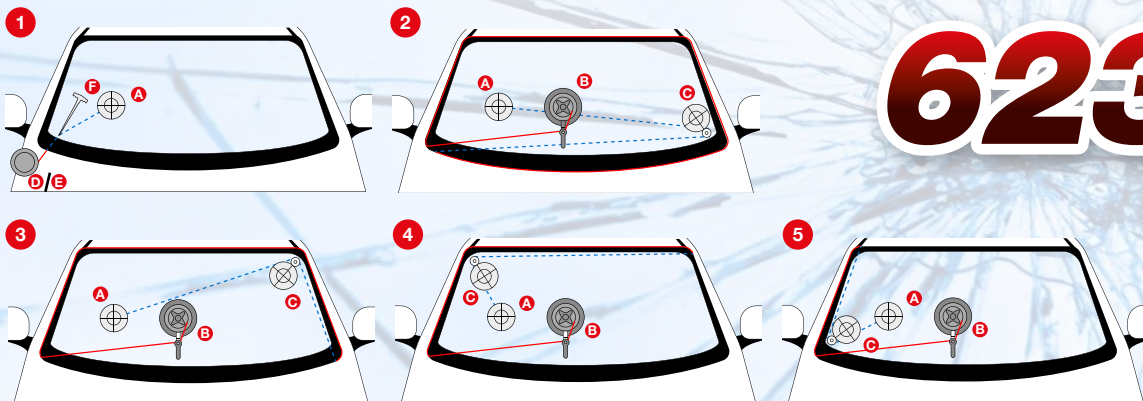

623,00

UKLJUČUJUĆI



140.2630 Univerzalni uređaj za razdvajanje diskova za samostalan rad

i  **1**
Ostale informacije

I ZA DOT5.1, ENV4 I ENV6



• Dot3 ✓
• Dot4 ✓



0 20 mm

155 mm

15,00

150.1969 Tester kočione tečnosti za DOT i ENV

i  **1**
Ostale informacije

PUMP IT UP!

29,00

Boca s raspršivačem za sredstvo za čišćenje kočnica

150.8258

TOP SELLER

VITON®
FKM



i specijalno za čišćenje kočnica ✓

i  **2**
Ostale informacije



11,00

Set univerzalnih kuka, mogu se oblikovati

150.1935

i  **12**
Ostale informacije



1/2" 11,5 mm 14 mm 15 mm 20 mm AS 22 mm

1/4" 9 x 20 mm

3/8" 7 x 72 mm
7 x 92 mm
9 x 50 mm
11 x 100 mm

3/8" 7 x 25 - 8 x 25 mm

52,00

Specijalan nasadni ključ za tijelo kočnice-set

150.2400 1/4" 3/8" 1/2" 



i  **41**
Ostale informacije

104,00

Alat za vraćanje kočionih klipova-set

150.1970

KONTROLA KOČNICA

8
Ostale informacije

UNIVERSAL

Za 95% svih vozila

2 pina
3 pina
3/8"
4 pina

135,00

150.2440 Univerzalni alat za vraćanje kočionih klipova-set

1
Ostale informacije

5L

727,00

160.0700 Uređaj za održavanje kočnica KS5

3
Ostale informacije

NEW

50,00

TESLA

Model 3 & Y
Model S & X

160.0695 Set prilagodnika za odzračivanje kočnica za Teslu



ZA 80% SVIH VOZILA

Ostale informacije

1



Ø 90 mm

3



Ø 55 mm

2



Ø 20 - 78 mm

4



E 20

5



0,2 L



79,00

160.0785

Set prilagodnika za odzračivanje kočnica

IZVOLITE, 1 ODZRAČIVANJE!



Ostale informacije



Mercedes
VAG
BMW
PSA
Volvo
Ford
Fiat
Porsche

1



54 mm



Dong Feng
Fengxing

9



52 mm

2



58 mm

Hyundai
Kia
Mitsubishi
Renault
Subaru

10



40 mm

Nissan

3



55 mm

Buick

11



42 mm

Wuling

4



55 mm

Audi
Ford
Peugeot

12



50 mm

Suzuki

5



72 mm

Honda

13



55 mm

Soueast

6



52 mm

Toyota

14



59 mm

Nissan

7



54 mm

Buick
Cadillac
Ford
Mazda

15



86 mm

Mitsubishi
Souesat

8



50 mm

Chrysler
Dodge
Jeep

16



56 mm

Tesla



119,00



17



Ø 27 mm



160.0815

Univerzalni set prilagodnika za odzračivanje kočnica

i 1
Ostale informacije

52,00

TOP SELLER

Max. 70 mm
Min. 28 mm

univerzalno podesivo

160.0718 Univerzalni alat za vraćanje kočionih klipova-set

i 1
Ostale informacije

TOYOTA & LEXUS

7,2 mm

1 + 2

17,00

160.0719 Set univerzalnih odzračnih otvora za Toyotu i Lexus

i 1
Ostale informacije

3U1

1 SAVIJANJE
2 UDVAJANJE
3 NAMJEŠTANJE

4,75 mm (3/16")
6,35 mm (1/4")

31,00

Alat za savijanje kočionih vodova / - alat za savijanje, 4,75 mm (3/16") + 6,35 mm (1/4")

120.1004

OVDJE JE ZRAK ISPUŠTEN!

i 6
Ostale informacije

72,00

1.200 mm

STOP

11 mm
10 mm
9 mm
8 mm
7 mm

160.0725 Set ključeva za odzračivanje kočnica

i 11
Ostale informacije

STOP

1.200 mm

9x12 mm

180 mm

TOP SELLER

11 mm
10 mm
11 mm
7 mm
11 mm
10 mm
11 mm
11 mm
85 mm

12 mm
29 mm
39 mm
45 mm
60 mm
70 mm
75 mm

78,00

518.0320 Set alata za odzračivanje kočnica za VAG

		DIN	SAE	4,75 mm	5,0 mm	6,0 mm	sa savijačem cijevi	S rezačem cijevi	s alatom za ravnanje ivice cijevi	mehanički	s hidrauličnim vretenom	Ručna pumpa	u koferu	
1	122.1215	✓	✗	✓	✗	✗	✗	✗	✗	✓	✗	✗	✗	
2	122.1290	✓	✓	✓	✓	✓	✓	✓	✓	✗	✓	✗	✓	
3	122.1260	✓	✓	✓	✓	✓	✗	✗	✗	✗	✗	✓	✓	

Ostale informacije

4

FLAREFIX eco

4,75 mm

Special Punch Grease

52,00

122.1215 **FLAREFIXeco 4,75 mm univerzalni set uređaja za obradu rubova**

Ostale informacije

16

FLAREFIX

DIN SAE

3,0-12,0 mm

3,0-6,0 mm

3,0-16,0 mm

4,75-5,0 mm, SAE

4,75 mm, 3/16"

6,0 mm, SAE

5,0 mm

4,75-5,0-6,0 mm, SAE-90°

6,0 mm

4,75-5,0 mm, DIN

6,0 mm

M12x1,25

6,0 mm

176,00

122.1290 **FLAREFIX 1 univerzalni alat za rubove vodova kočnica sa hidraulično vreteno**

NAJBOLJI IZBOR: JEDNOSTAVNO UNIVERZALNO

Ostale informacije

11

FLAREFIX II Hydraulic

M12 x 1,25 mm

3,0-12,0 mm

4,75-5,0 mm, SAE

3,0-6,0 mm

6,0 mm, SAE

3,0-16,0 mm

4,75-5,0-6,0 mm, SAE-90°

4,75 mm, 3/16"

4,75-5,0 mm, DIN

5,0 mm

6,0 mm, DIN

6,0 mm

M12x1,25

6,0 mm

311,00

122.1260 **FLAREFIX 2 univerzalni uređaj za fitinge kočionih vodova-set s hidrauličnim cilindrom**



Ostale informacije



3/8"



1 Ford/PSA



2 BMW



3 VAG



4 Mercedes



5 DAF/MAN



6 GM



7 Ford



8 Ford



9 Ford



26,00

3/8" set specijalnih profila za servisiranje ulja, za plastične vijke za ispuštanje ulja, 9-dijelni

150.1040



Ostale informacije

8,50

Ø 340 mm

6 LITARA



120 mm

1

150.9593

Uređaj za prihvat iscurjele tekućine 6 litara



Ostale informacije

13,00

Ø 385 mm

7,5 LITARA



130 mm

2

150.9359

Uređaj za prihvat iscurjele tekućine 7,5 litara



Ostale informacije

KADICA NIKAD NIJE PUNA!

NEW

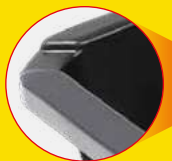

50 LITARA

595 mm

875 mm

110 mm

35,00

3

150.9592

Uređaj za prihvat iscurjele tekućine / višenamjenska kadica, 50 litara

i  **1**
Ostale informacije

NEW



25,00

1/2"

63,8 mm

14

150.9469 **Tesla Ključ za filter za ulje**

i  **30**
Ostale informacije

104,00

1/2" 21 mm

Ø 63 - 102 mm

3/8"

65-14, 65/67-14, 66-6, 68-14, 73-14, 74-15, 74/76-15, 75/77-15, 76-8, 76-12, 76-14, 76-30, 78-15, 80-15, 80/82-15, 86-18, 86-16, 90-15, 92-10, 93-15, 93-36, 93-45, 95-15, 96-18, 100-15, 106-15, 108-15, 108-18

150.9350 **3/8" set ključeva za filter za ulje**



i  **24**
Ostale informacije

104,00

TOP SELLER

VW Lexus Lotus Ford Nissan
Subaru Mitsubishi Land Rover Hyundai Audi
Chrysler Toyota Citroën Volvo Cadillac
Citroën Buick Volvo Buick univerzalno

2,0 L

150.9130 **MASTER Lijevak za punjenje ulja.set s okretnim ugonim krakom**



i  **4**
Ostale informacije

ZA VAG

okretni kutni krak za teško pristupačna mjesta

15,00

2,0 L

150.9155 **Set lijevaka za punjenje ulja s obrtnim ugonim krakom za VAG**



i **1**
Ostale informacije

200 kg

1.385 mm

695 mm

Ø 550 - 750 mm

195,00

160.0070 performance Profesionalna kolica za gume

i **1**
Ostale informacije

680 kg

max. 300 mm

345 - 650 mm

AL 225,00

HIDRAULIČNO max. 750 mm max. 300 mm

A

160.1205

i **1**
Ostale informacije

680 kg

max. 330 mm

325 - 725 mm

AL 185,00

MEHANIČKI max. 1000 mm max. 330 mm

B

160.1210

performance policica za odlaganje s četiri pomoćna elementa za manevriranje

A HIDRAULIČNO

B MEHANIČKI

od **785,00**

4x

A	160.1220		hidraulično	930,00 €
B	160.1225		mehanički	785,00 €

i **1**
Ostale informacije

performance hidraulična automobilska cilindrična dizalica

max. 50 t

od 30,00

A

B

C

D

	maks. podizna nosivost t	min. A mm	max. A mm	B mm	C x D mm	
160.1100	2,0	170,0	315,0	145,0	95 x 80	30,00 €
160.1105	5,0	205,0	400,0	195,0	120 x 100	40,00 €
160.1110	10,0	220,0	445,0	225,0	125 x 105	45,00 €
160.1115	16,0	225,0	455,0	230,0	140 x 120	60,00 €
160.1120	20,0	235,0	445,0	210,0	155 x 125	75,00 €
160.1125	30,0	275,0	440,0	165,0	175 x 150	130,00 €
160.1130	50,0	265,0	425,0	160,0	210 x 175	185,00 €

POKREĆE AUTOMOBILE U SEKUNDI!

i **2** **performance Čelično postolje s brzim podešavanjem, u paru**

max. 12 t

od 40,00

ISPORUČUJE SE U PARU

	maks. nosivost t	min. A mm	max. A mm	B mm	C mm	
160.1245	2,0	280,0	420,0	195,0	170,0	40,00 €
160.1250	3,0	290,0	430,0	200,0	175,0	50,00 €
160.1255	6,0	390,0	610,0	285,0	250,0	90,00 €
160.1260	12,0	500,0	760,0	330,0	300,0	200,00 €

i **2** **AL 4,2! 3 t**

ISPORUČUJE SE U PARU

130,00

performance aluminijски stalak, u paru

160.1240

KVALITETNO OBRADENO ✓

NAJLONSKI VALJCI ✓

GUMENI TANJUR ✓

NJEŽNO OTPUŠTANJE ✓

GUMIRANA ZAŠTITA OD UDARACA ✓

i **1** **AL 14! 165,00**

1,5 t

- 360 mm MAX HÖHE/HEIGHT
- 5pumps
- 270 mm
- with Absorb-Function (with lowering function)
- SAFETY OIL-BYPASS-TECHNOLOGY
- 82x6 mm

performance Hidraulična aluminijска dizalica za vozila

160.1000

i **1** **AL 27! 240,00**

2,5 t

- 450 mm MAX HÖHE/HEIGHT
- 7pumps
- 350 mm
- with Absorb-Function (with lowering function)
- SAFETY OIL-BYPASS-TECHNOLOGY
- 96x7 mm

performance Hidraulična aluminijска dizalica za vozila

160.1005

IZDVAJA SE OD KONKURENCIJE



Ostale informacije

245,00

3 t

120 mm

340 mm

665 mm

performance
Hidraulična čelična dizalica za vozila

160.1010

↑ 456 mm
MAX
HÖHE/
HEIGHT

6,5 pumps

336 mm

with the AbsorbFunction
with Learning Function

SAFETY
OIL-BYPASS-
TECHNOLOGY

110x9 mm



Ostale informacije

250,00

2,5 t

75 mm

340 mm

750 mm

performance
Hidraulična čelična dizalica za vozila

160.1015

↑ 510 mm
MAX
HÖHE/
HEIGHT

7 pumps

435 mm

with the AbsorbFunction
with Learning Function

SAFETY
OIL-BYPASS-
TECHNOLOGY

110x9 mm



Ostale informacije

270,00

3 t

75 mm

345 mm

750 mm

performance
Hidraulična čelična dizalica za vozila

160.1020

↑ 510 mm
MAX
HÖHE/
HEIGHT

7 pumps

435 mm

with the AbsorbFunction
with Learning Function

SAFETY
OIL-BYPASS-
TECHNOLOGY

110x9 mm

ŽIVJELI PODIZAČI!





Ostale informacije



610 mm
MAX
HÖHE/
HEIGHT



5pumps



535 mm



SAFETY
OIL-BYPASS-
TECHNOLOGY



110x9 mm

SAMO
75
mm

2 t



75 mm
380 mm
875 mm

485,00

160.1025

performance
Hidraulična čelična dizalica za vozila





Ostale informacije



510 mm
MAX
HÖHE/
HEIGHT



4pumps



440 mm



SAFETY
OIL-BYPASS-
TECHNOLOGY



92x5,5 mm

SAMO
70
mm

3 t



70 mm
365 mm
805 mm

565,00

160.1030

performance
Hidraulična čelična dizalica za vozila





Ostale informacije



510 mm
MAX
HÖHE/
HEIGHT



7pumps



425 mm



SAFETY
OIL-BYPASS-
TECHNOLOGY



110x9 mm

SAMO
85
mm

3 t



85 mm
360 mm
740 mm

410,00

160.1035

performance
Hidraulična čelična dizalica za vozila





Ostale informacije



540 mm
MAX
HÖHE/
HEIGHT



8pumps



445 mm



SAFETY
OIL-BYPASS-
TECHNOLOGY



116x8,5 mm

SAMO
95
mm

3,5 t



95 mm
345 mm
760 mm

445,00

160.1040

performance
Hidraulična čelična dizalica za vozila

i

Ostale informacije

5 t

570,00

4 t

350-710 mm

65-405 mm

720 mm

260 mm

performance
Podizač za viličar, hidraulični

160.1050

i

Ostale informacije

od

895,00

max. 10 t

A

B

C

D

performance
Hidraulična čelična dizalica za vozila

		maks. podizna nosivost	min. A mm	max. A mm	B mm	C mm	D mm	
160.1060		5,0	150,0	685,0	535,0	1510,0	365,0	895,00 €
160.1065		10,0	160,0	560,0	400,0	1640,0	495,0	1135,00 €

i

Ostale informacije

od

855,00

max. 80 t

A

B

C

D

performance Pneumatsko-hidraulična dizalica za vozila

		maks. podizna nosivost	min. A mm	max. A mm	B mm	C mm	D mm	
160.1075		32 / 16	150,0	295,0	145,0	900,0	290,0	855,00 €
160.1080		40 / 25 / 15	125,0	300,0	175,0	920,0	285,0	1045,00 €
160.1085		40 / 20 / 15 / 10	100,0	275,0	175,0	920,0	300,0	1120,00 €
160.1090		80 / 40	195,0	380,0	185,0	645,0	345,0	975,00 €

ZA PROŠIRENJE

i

Ostale informacije

120,00

2 t

120 mm

710 mm

može se izvući s obje strane

performance Poprečni nosač za dizalicu za vozila

160.1045

i 1
Ostale informacije

20 t

performance Hidraulička radionička presa

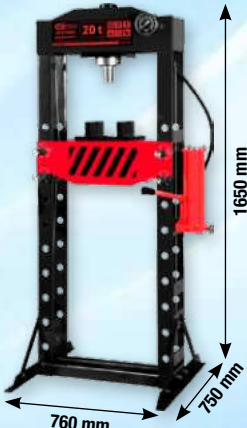

1650 mm
760 mm
750 mm

860,00

160.1150

i 1
Ostale informacije

30 t

performance Hidraulička radionička presa

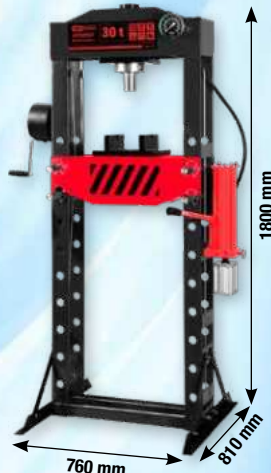

1800 mm
760 mm
810 mm

1405,00

160.1155

i 1
Ostale informacije

50 t

performance Hidraulička radionička presa

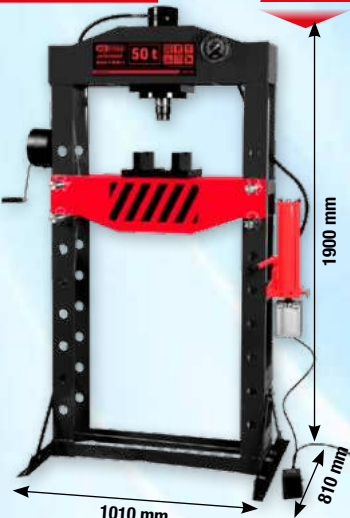

1900 mm
1010 mm
810 mm

2050,00

160.1160

i 1
Ostale informacije

performance zaštitna rešetka za hidraulične radioničke preše

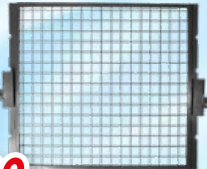

od 155,00

	primjena za	dužina mm	širina mm	
160.1151	160.1150	600,0	500,0	155,00 €
160.1156	160.1155	600,0	500,0	165,00 €
160.1161	160.1160	600,0	690,0	185,00 €

i 8
Ostale informacije

125,00

10 x 50 mm 2t
12 x 60 mm 3t
16 x 60 mm 8t
18 x 85 mm 12t
20 x 85 mm 14t
22 x 85 mm 16t
25 x 110 mm 18t
30 x 110 mm 20t



performance set pritisnih trnova za hidraulične radioničke preše

160.1165

i 1
Ostale informacije

680 kg

performance Teleskopski podložni potpornik



360°
85 mm
M 30
1365 - 2060 mm
420 mm

150,00

160.1265

i 1
Ostale informacije

500 kg

performance Hidraulični podizač prijenosnika



815 mm
1110 - 1925 mm
630 mm

255,00

160.1270

i 1
Ostale informacije

500 kg

performance Hidraulični podizač prijenosnika sa stolom



990 mm
770 mm
900 - 1890 mm

985,00

160.1305

ODGOVARA ZA KAVALE ZA VOZILA

i  **1**
Ostale informacije



1 t

190-770 mm

530 mm

930 mm

960,00

performance
Hidraulični podizač prijenosnika sa podesivom prihvatnom pločom

160.1330

i  **1**
Ostale informacije



1,5 t

220-940 mm

655 mm

1085 mm

1235,00

performance
Hidraulični podizač prijenosnika sa podesivom prihvatnom pločom

160.1335

i  **1**
Ostale informacije



1 t

925 mm

895-1820 mm

1045,00

790 mm

performance
Hidraulični podizač prijenosnika sa stolom

160.1310

i  **1**
Ostale informacije



2 t

min. 190 - max. 2380 mm

950 mm

1085 mm

495,00

performance
radionička dizalica, sklopiva

160.1290

i  **1**
Ostale informacije



70,00

performance
Mehanizam za pozicioniranje tereta

680 kg

440 mm

160.1291

i 1
Ostale informacije

680 kg

890 mm
825 mm
900 mm

195,00

160.1285 performance Držać motora

i 1
Ostale informacije

LAKO PREMOŠĆIVANJE!

1550 mm
320 mm
500 kg

75,00

160.0265 performance Most za motor

i 1
Ostale informacije

35 kg

740 mm
760 mm
950 - 1300 mm

175,00

performance
160.0215 Univerzalni stol za odlaganje, podesiv po visini

i 1
Ostale informacije

200 kg

65,00

160.0216 performance podna ploča

ZA PROŠIRENJE

ZA TRANSPORT GUMA I BURADI S ULJEM



i  **1**
Ostale informacije

465,00

500 kg



max. 600 mm
275 - 875 mm
500 mm
935 mm

performance
160.1315 Hidraulički sto za odlaganje pokretan

i  **1**
Ostale informacije

195,00

250 kg



240 - 570 mm
250 mm
700 mm
1160 mm



160.0255 performance XXL podizač kotača

i  **1**
Ostale informacije

VAŠ OSOBNI LIFTBOJ!

700 kg



190 mm
1160 mm
1090 mm
895 mm



659,00

160.1200 performance Hidraulički podizač kotača



Ostale informacije

ZVIJEZDA NA SVAKOJ BINI

GUMENA PODLOGA OD PUNE GUME

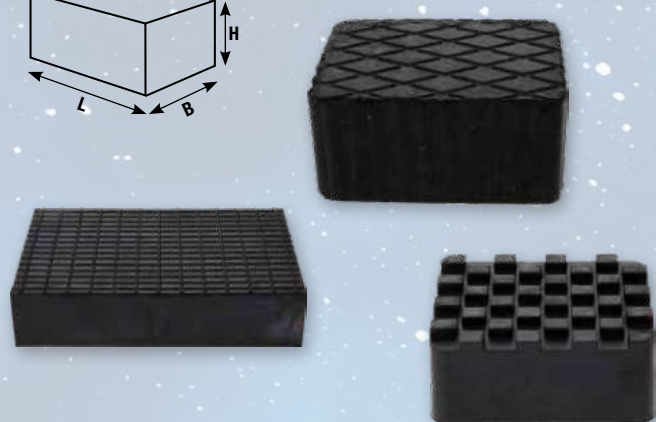
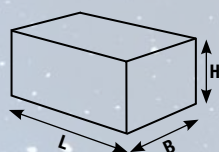

	Dijelovi	L mm	B mm	H mm		
	160.0476	1	160	120	20	5,00 €
	160.0477	1	160	120	30	7,00 €
	160.0478	1	160	120	40	9,00 €
	160.0479	1	160	120	60	13,00 €
	160.0480	1	160	120	80	17,00 €
	160.0481	1	160	120	100	21,00 €
	160.0482	1	160	120	115	25,00 €
	160.0483	1	116.5	116,5	36,5	6,00 €
	160.0499	1	160	120	85	18,00 €
	160.0507	1	120	100	50	6,00 €
	160.0527	1	160	120	20	5,00 €
	160.0547	1	220	140	50	16,00 €

GUMENA PODLOGA OD PUNE GUME

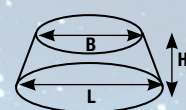

	Dijelovi	L mm	B mm	H mm		
	160.0439	1	120	120	100	10,00 €
	160.0485	1	105	78	60	10,50 €
	160.0503	1	150	150	70	14,00 €
	160.0513	1	150	150	60	11,00 €
	160.0514	1	150	150	50	10,00 €
	160.0518	1	150	150	100	20,00 €
	160.0524	1	150	150	140	27,00 €
	160.0548	1	135	100	30	6,00 €
	160.0552	1	160	120	90	16,00 €
	160.0605	1	135	100	70	15,00 €
	160.0609	1	120	120	60	10,00 €
	160.0616	1	135	135	42	12,00 €
	160.0617	1	140	100	60	10,00 €
	160.0618	1	140	100	120	16,00 €

GUMENI TANJUR ZA PODIZNE PLATFORME

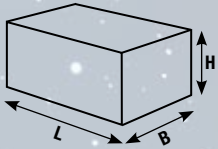

	Dijelovi	L mm	B mm	H mm		
	160.0531	1	400	350	12	20,00 €
	160.0586	1	360	260	12	45,00 €
	160.0604	1	460	300	30	105,00 €
	160.0598	1	104	82	8	2,00 €



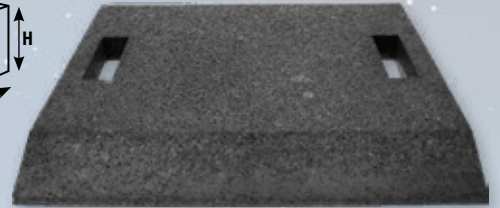
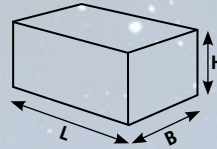



POMOĆNI PRILAZNI ELEMENT ZA PODIZNE PLATFORME

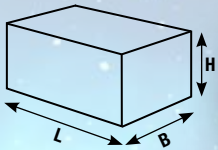

	Dijelovi	L mm	B mm	H mm		
	160.0565	1	1000	500	30	80,00 €
	160.0566	1	1000	500	40	98,00 €
	160.0567	1	1000	500	50	109,00 €
	160.0607	1	500	500	40	60,00 €

ZAŠTITNI BLOK OD PE (POLIETILEN)



	Dijelovi	L mm	B mm	H mm		
	160.0437	1	250	150	55	15,00 €
	160.0438	1	250	150	100	28,00 €
	160.0486	1	340	150	55	20,00 €
	160.0489	1	340	130	100	33,00 €
	160.0595	1	1350	140	45	55,00 €
	160.0596	1	1350	140	105	105,00 €

GUMENA PODLOGA ZA POSTOLJA

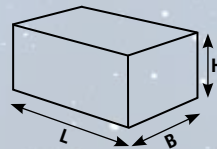

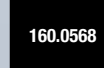
	Dijelovi	L mm	B mm	H mm		
	160.0568	1	89	53	48	7,00 €

GUMENA PODLOGA SA ŽLIJEKOM

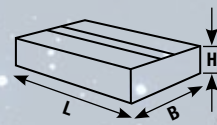

	Dijelovi	L mm	B mm	H mm		
	160.0484	1	373	100	35	41,00 €

GUMENA PODLOGA ZA RANŽIRNE DIZALICE

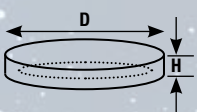

	Dijelovi	D mm	H mm			
	160.0562	1	65	42	Gumena podloga Universal za ranžirne dizalice, pragove	7,00 €
	160.0564	1	67	33	Gumena podloga za BMW / Mini / Opel / Mercedes	7,00 €
	160.0569	1	66	32	Gumena podloga za Audi	7,00 €
	160.0570	1	78	43	Gumena podloga za Mercedes	7,00 €

SET GUMENIH PODLOGA OD PUNE GUME

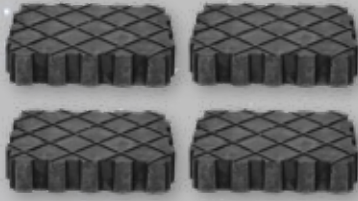

	Dijelovi	L mm	B mm	H mm	
160.0391-TD	4	155	125	35	36, ⁰⁰ €

SET PRIHVATA ZA AUTOMOBILSKE DIZALICE



Model 3 ✓
Model S ✓
Model X ✓
Model Y ✓



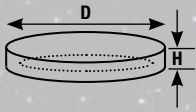

	Dijelovi		
160.0460	4	Tesla Model 3, S, X, Y	25, ⁰⁰ €

GUMENI TANJUR S ČELIČNOM PLOČOM



ČELIČNA PLOČA





	D mm	H mm	AMI	ATH	Autop	BEISSBARTH	CE-300	Consul	Ebing	Herrmann	HOFMANN	HTC	IMED	J.A. Becker	MAHA	MWH	Mussbaum	Ravaglioli	Sift	Stenhoj	Werther	Zippo		
	160.0444	123	15																				✓	8, ⁰⁰ €
	160.0463	120	22												✓									9, ⁰⁰ €
	160.0465	123	25															✓			✓			9, ⁰⁰ €
	160.0475	120	19	✓						✓	✓			✓										9, ⁰⁰ €
	160.0504	121	10			✓															✓			8, ⁰⁰ €
	160.0516	127	28	✓													✓		✓					8, ⁰⁰ €
	160.0517	130	30	✓													✓		✓					8, ⁰⁰ €
	160.0533	123	16			✓															✓			8, ⁰⁰ €
	160.0536	137	18					✓								✓								10, ⁰⁰ €
	160.0541	123	24															✓			✓			8, ⁰⁰ €
	160.0555	135	20			✓		✓		✓													✓	8, ⁰⁰ €
	160.0574	153	32				✓		✓														✓	13, ⁰⁰ €
	160.0575	150	15																				✓	11, ⁰⁰ €

		D mm	H mm	AMI	ATH	Autop	BEISSBARTH	CE-300	Consul	Ebing	Herrmann	HOFMANN	HTC	IMED	J.A. Becker	MAHA	MWH	Nussbaum	Ravaglioli	Slift	Stenhoj	Werther	Zippo		
	160.0576	100	15																					✓	8,00 €
	160.0583	155	15											✓						✓					8,00 €
	160.0584	122	12,5											✓						✓					8,00 €
	160.0588	158	11,5			✓															✓				10,00 €
	160.0608	135	75				✓		✓														✓		16,00 €

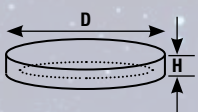
GUMENI TANJUR S ČELIČNIM PRSTENOM

ČELIČNI PRSTEN









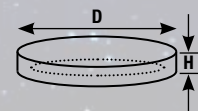





















		D mm	H mm	AMI	ATH	Autop	BEISSBARTH	CE-300	Consul	Ebing	Herrmann	HOFMANN	HTC	IMED	J.A. Becker	MAHA	MWH	Nussbaum	Ravaglioli	Slift	Stenhoj	Werther	Zippo		
	160.0543	127	21																					✓	3,00 €
	160.0546	130	17								✓														3,00 €
	160.0551	160	21									✓													4,00 €
	160.0559	140	18									✓													4,00 €















GUMENA PODLOGA

GUMA



		D mm	H mm	AC	Adami	AGM	ATH	Cascos	ETG	EVER ETERNAL	Grazia	Herrmann	HOFMANN	HTC	Intertech	Isobal	J.A. Becker	Koni	Launch	MAHA	Nordlift	Nussbaum	OMCN	Ravaglioli	Rometco	Rotary	RP Tools	Sirio	Slift	Space	Twin Busch	Velyen	Omegaheber		
	160.0440	123	24																					✓											4,00 €
	160.0464	120	23																	✓															5,00 €
	160.0466	125	24																			✓													12,00 €

		D mm	H mm	AC	Adami	AGM	ATH	Cascos	ETG	EVER ETERNAL	Grazia	Herrmann	HOFMANN	HTC	Intertech	Isobal	J.A. Becker	Koni	Launch	MAHA	Nordlift	Nussbaum	OMCN	Ravaglio	Romeico	Rotary	RP Tools	Sirio	Sift	Space	Twin Busch	Veyen	Omegaheber		
	160.0467	140	25																																6,00 €
	160.0468	100	14																					✓			✓		✓						5,00 €
	160.0469	120	32															✓								✓								8,00 €	
	160.0470	150	23																					✓										5,00 €	
	160.0471	140	30																															8,00 €	
	160.0472	130	14																					✓			✓		✓					7,00 €	
	160.0473	120	30																															7,00 €	
	160.0474	120	19				✓					✓	✓				✓																	5,00 €	
	160.0490	100	21																					✓										4,00 €	
	160.0491	120	26								✓													✓										5,00 €	
	160.0492	120	26																					✓										5,00 €	
	160.0493	145	24																					✓	✓									8,00 €	
	160.0494	145	26																					✓										7,00 €	
	160.0495	160	28												✓																			7,00 €	
	160.0496	140	25																					✓										8,00 €	
	160.0497	150	25																					✓	✓									6,00 €	
	160.0498	140	28																					✓										9,00 €	
	160.0508	120	18,5																	✓								✓						3,00 €	
	160.0519	160	27					✓						✓	✓		✓								✓									5,00 €	
	160.0534	120	20														✓																	5,00 €	
	160.0535	123	20,5																							✓								3,00 €	
	160.0544	120	40																				✓											9,00 €	
	160.0549	109	27,5															✓																3,00 €	
	160.0553	127	22																		✓													3,00 €	
	160.0554	139	26,5		✓																													5,00 €	

		D mm	H mm	AC	Adami	AGM	ATH	Cascos	ETG	EVER ETERNAL	Grazia	Herrmann	HOFMANN	HTC	Intertech	Isobal	J.A. Becker	Koni	Launch	MAHA	Nordlift	Nussbaum	OMCN	Ravaglioli	Romeico	Rotary	RP Tools	Sirio	Slift	Space	Twin Busch	Veylen	Omegaheber	
	160.0557	125	12,6																							✓								3,00 €
	160.0571	100	15,5																													✓		4,00 €
	160.0577	105	17,5	✓																														3,00 €
	160.0585	124	16,5														✓																	2,00 €
	160.0587	140	22																													✓		8,00 €
	160.0589	115	20														✓																	5,00 €
	160.0590	100	17																	✓														2,00 €
	160.0591	100	20																					✓		✓	✓							3,00 €
	160.0593	124	22																						✓									3,00 €
	160.0594	140	25					✓																										5,00 €
	160.0597	145	7													✓																✓		3,00 €
	160.0599	110	20	✓																														5,00 €
	160.0601	143	26,5																						✓									8,00 €
	160.0603	130	32							✓																								9,00 €

GUMENA PODLOGA



GUMA

		L mm	B mm	H mm	AC	HOFMANN	MAHA	Romeico	Rotary	UNIVERSAL		
	160.0525	162	92	25		✓						5,00 €
	160.0528	150	80	28				✓				5,00 €
	160.0529	120	120	25						✓		3,00 €
	160.0561	112	61	17	✓		✓		✓			3,00 €
	160.0602	128	89	35					✓			7,00 €

i **7**
Ostale informacije

NEW

29,00

100.5100 Set alata za čišćenje sjedišta ventila za aluminijske naplatke

i **1**
Ostale informacije

8,00

800.0156 Plastična posuda sa magnetom, Ø 150 mm

i **1**
Ostale informacije

Ostale okrugle gumice za brisanje nalaze se na stranici 61

NEW

12,50

515.5471 Gumica za brisanje aluminijskih naplataka, konusna

i **1**
Ostale informacije

0 - 10 bar

BAŽDAREN

64,00

515.1960 Baždaren pneumatski mjerac zraka u gumama

i **1**
Ostale informacije

0 - 12 bar

20,00

515.1950 Pneumatski mjerac zraka u gumama

i **6**
Ostale informacije

CIJENA PO SETU = 6X

60,00

NEW

515.5476

i **5**
Ostale informacije

59,00

150.1070 Vulkanizerski set za gume za teretna vozila, uključujući navoje od 100 mm

NEOBAVEZAN
60 komada
18,00

150.1072

ZA APSOLUTNO SJAJAN USPJEH!

i   7
Ostale informacije

25,00

NEOBAVEZAN

100.5085 Set brusilica za klinove i glavinu kotača, Ø 40 mm

100.5087 Ø 40 mm  6x 20,00 €

Prije:

Posle:





i   7
Ostale informacije

49,00

NEOBAVEZAN

100.5090 Set brusilica za klinove i glavinu kotača, Ø 50 / 60 mm

100.5091	Ø 50 x 12 mm	 10x	25,00 €
100.5092	Ø 50 x 13 mm	 10x	25,00 €
100.5093	Ø 50 x 14 mm	 10x	25,00 €
100.5094	Ø 60 x 16 mm	 10x	40,00 €
100.5096	Ø 60 x 22 mm	 10x	40,00 €
100.5097	Ø 60 x 28 mm	 10x	40,00 €

Prije:

Posle:





i   2
Ostale informacije

93,00

NEOBAVEZAN

100.5080 Set brusilica za glavinu kotača, aluminij, Ø 150 mm, unutarnji Ø 90 mm

100.5077 Ø 150 mm  1x 36,00 €

Prije:

Posle:





i  **11**
Ostale informacije

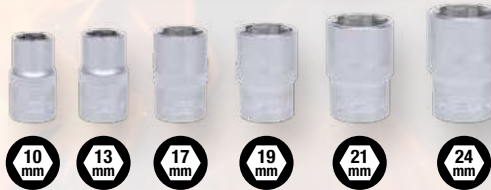
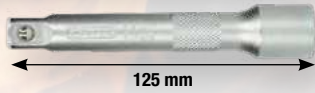

1/2"

500 mm



sa pregledni znak
DIN EN ISO 6789
Sertifikat
tačnost
+/-3%



124,00

516.2400 1/2" 10 - 13 - 17 - 19 - 21 - 24 mm



i  **12**
Ostale informacije

ĐAVOLSKI DOBRO! PAKLENO POVOLJNO!

**TOP
SELLER**



1/2"



1/2"

sa pregledni znak
DIN EN ISO 6789
Sertifikat
tačnost
+/-3%



515.2101

112



+

1/2"



+ 4x

199,00

+



+





15



Set alata za demontažu brave na naplatcima

Ostale informacije



YouTube

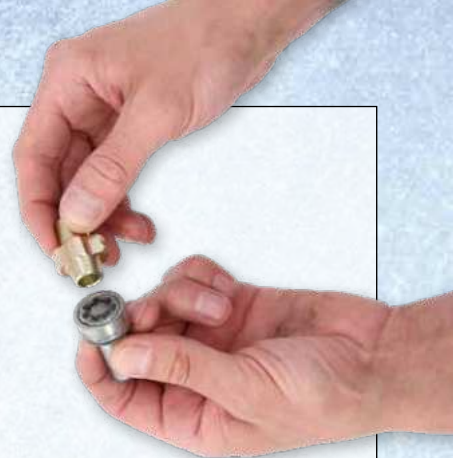

sa zaštitom za ruke



14 mm

pjena



Ø 21,5 mm



Ø 21,5 mm

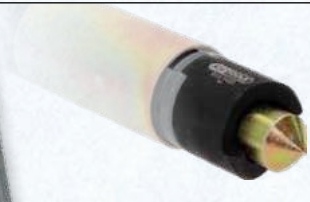

Ø 16 mm

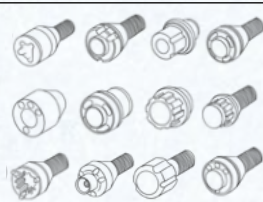

Ø 10,5 mm



Ø 9,5 mm

145,00



obostrano primjenjivo



NEOBAVEZAN

7,00

913.1431



152 mm



38 mm

1/2"



143 mm

24 mm

3x



Ø 25 mm



Ø 30 mm

913.1430



Ostale informacije

Set za demontažu osigurača kotača

913.1480 18 - 19 - 20 - 21 - 22 - 23 - 24 - 25 mm

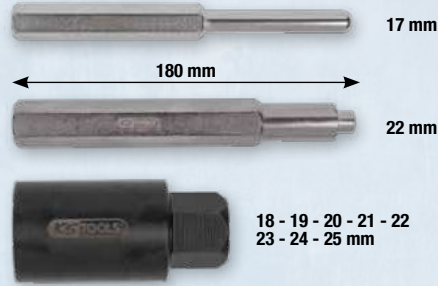
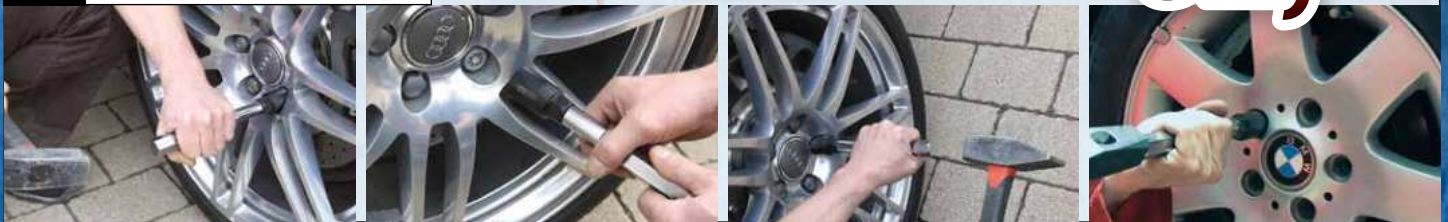

62,00

NEISPRAVNI VIJCI?

NEMA PROBLEMA!



Ostale informacije



41,00

1/2" set nasadnih ključeva spiralnog profila za teretna vozila, 3-dijelni

913.1270 1/2" 17 - 19 - 21 mm



Ostale informacije



29,00

Set specijalnih snažnih nasadnih ključeva za Ford, 18,5 / 19,5 / 20,5 / 21,5 mm

515.0895 1/2" 18,5 - 19,5 - 20,5 - 21,5 mm



Ostale informacije



35,00

515.0850 1/2" 16,5 - 17,5 - 18,5 - 19,5 - 20,5 - 21,5 mm

Set specijalnih snažnih nasadnih ključeva za aluminijske naplatke

NEW

i **3**

Ostale informacije

17 mm 17 mm 17 mm

85 mm

12,50

515.0860 1/2" 3 x 17 mm

NEW

i **3**

Ostale informacije

19 mm 19 mm 19 mm

85 mm

12,50

515.0855 1/2" 3 x 19 mm

NEW

i **3**

Ostale informacije

17 mm 19 mm 21 mm

85 mm

15,00

515.0875 1/2" 17 - 19 - 21 mm

i **3**

Ostale informacije

21 mm 19 mm 17 mm

85 mm

18,00

515.1070 1/2" 17 - 19 - 21 mm

NEW

i **3**

Ostale informacije

EKSTRA DUGO

150 mm

21 mm 19 mm 17 mm

38,00

515.0865 1/2" 17 - 19 - 21 mm

i **5**

Ostale informacije

15 mm 17 mm 19 mm 21 mm 22 mm

85 mm

26,00

515.0870 1/2" 15 - 17 - 19 - 21 - 22 mm

i **10**

Ostale informacije

17 mm 15 mm 19 mm 22 mm 23 mm

85 mm

72,00

515.0890 1/2" 15 - 17 - 19 - 21 22 - 23 - 24 mm

7/8" 17 mm MS21

21 mm 17 mm 21 mm 24 mm

i **17**

Ostale informacije

15 mm 17 mm 19 mm 21 mm 22 mm 23 mm 24 mm

85 mm

145,00

515.0885 1/2" 15 - 17 - 19 - 21 - 22 - 23 - 24 mm 7/8" 17 mm MS21 17 - 19 - 21 mm 18,5 / 19,5 - 20,5 / 21,5 - 17,5 / 22,5 mm



VAŠ SNAŽAN PARTNER

**ZA SERWISE KOMERCIJALNIH VOZILA
S NAJVEĆIM IZBOROM ALATA ZA KOMERCIJALNA VOZILA**



**IZDRŽLJIVI SPECIJALNI ALATI ZA
NAJTEŽE PRIMJENE!**



**STRANICE
528**

**ARTIKL
>6.000**

**POGLAVLJE
23**

www.kstools.com

Prodaja samo specijaliziranim prodavaonicama.



Ostale informacije

Područja primjene:
Volvo FM i FH



Ø 75 mm

480,00

Zatezač opruge
za amortizere kabine

460.5700



Ostale informacije

DAF - IVECO
MAN - RENAULT
VOLVO - SCANIA



455.0110

Ispitni uređaj za rashladni sustav za komercijalna vozila



299,00



Ostale informacije

NEW



455.0195

Sustav za punjenje vakuuma u rashladne sustave

165,00



Ostale informacije

NEW



460.3985

Set alata za montažu brtvenog prstena za Scaniu

299,00



Ostale informacije

FUSO - IVECO

NEW



M16 x 2

M12 x 1,25

460.4475

Set alata za montažu brtvenog prstena za Fuso i Iveco

150,00



Ostale informacije

MERCEDES - MAN



1/2"

Područja primjene:
Mercedes Actros i Atego,
MAN 5-/6- i 8 cilindara
motor - D25/28 itd.

455.0021

Mehanizam za rotiranje motora za Mercedes / MAN

134,00



i **6**
Ostale informacije



MAN - MERCEDES



Područja primjene: čahure za cilindar za MAN, Mercedes itd.



Ø 60 - 160 mm

549,00



460.1815 **Alat za vađenje čahura cilindra-set**

i **5**
Ostale informacije



VOLVO

344,00



Područja primjene: Volvo FM12

460.1805 **Set skidača čahura ubrizgivača za Volvo**

i **14**
Ostale informacije

**TOP
SELLER**

135,00



i **3**
Ostale informacije



KNORR

55,00

NEW



i
Za Deutsch DT

460.0505 **Set alata za otključavanje utičnica za Knorr kočnice**

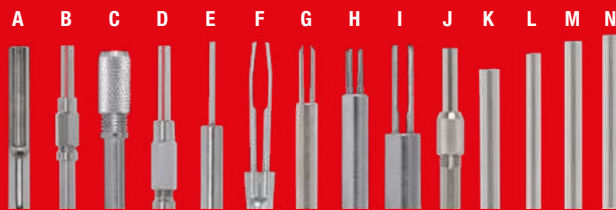

- | | | | |
|---|---|---|--|
| A | 4,0 mm, (ABS) | H | 1,5 mm |
| B | 3,5 mm (AMP Tyco 3,5) | I | 2,5 mm |
| C | 4,0 mm | J | 5,5 mm |
| D | 2,5 mm (AMP Tyco 2,3, Delphi 2,3, GHW 2,3) | K | Ø 1,5 mm (AMP Tyco 1,5) |
| E | 2,8 mm (AMP Tyco JT, AMP Tyco ST, DT) | L | Ø 3,5 mm (AMP Tyco 3,5) |
| F | 2,8 mm, 4,8 mm, 5,8 mm, 6,3 mm (AMP Tyco JPT, AMP Tyco SPT, AMP Tyco, TAB, Delphi HVF2, GHW DFK, GHW MDK 3) | M | Ø 2,3 mm (AMP Tyco 2,3, Delphi 2,3, GHW 2,3) |
| G | 2,8 mm | N | 4,0 mm |

150.1215 **Set alata za otključavanje za komercijalna vozila**



24 V

i  **4**
Ostale informacije



DAF CF85

NEW



Ø 119,7 mm

Ø 125 mm

Ø 148 mm

Ø 138 mm

300,00

460.4350 Set alata za montažu i demontažu ležaja glavčine za DAF

i  **3**
Ostale informacije



VOLVO FM12

NEW



Ø 109 mm

Ø 147 mm

Ø 124 mm

175,00

460.4010 Set alata za montažu i demontažu ležaja glavčine za VOLVO

i  **6**
Ostale informacije



Ø 30 mm

Ø 27 mm

Ø 25 mm

Ø 20 mm

Ø 36 - 45 mm

Ø 42 - 52 mm

208,00

UNIVERSAL

**TOP
SELLER**

150.2450 Univerzalni centrirajući alat za kvačilo-set za komercijalna vozila





od **29,00**

MERCEDES ACTROS

32 EPL **3/4"** **32 EPL**

50 mm

90 mm

Ø mm

A	460.0012			EPL 32	44,0	50,0	29,00 €
B	460.0013			EPL 32	44,0	90,0	39,00 €



1

95,00

M22 x 90

Ostale informacije

75 mm

30 mm

7.000 kg

32 mm

450.0070 **Univerzalni skidač kugličnih zglobova**

12

SAF MERCEDES

M12x1,75 mm

Ø 55 / 30 mm

Ø 138 mm

Ø 55 / 30 mm

Ø 30 mm

Ø 74 / 30 mm

Ø 139 - 159 mm

Ø 165 mm

Ø 138 mm

Ø 165 mm

30 x 500 mm

Područja primjene: SAF i Mercedes osovine

1500,00

460.4885 **Set 3D buksni za SAF osovine, Mercedes DCA i HT osovine**



19

VOLVO - DB/RENAULT
MAN TGA - SAF

Primjena:
Ø 51 mm - Volvo FM12
Ø 60 mm - DB / Renault (430/450/460)
Ø 68 mm - MAN-TGA (140/414/460) opruga
prednje osovine ROR, SAF

max. 12t

Ø 68 mm
MAN-TGA
(410/414/460)

Ø 51 mm
VOLVO(FM12)

Ø 60 mm
RENAULT
(430/450/460)

1995,00

460.1705 **Set alata za buksne s prorezom silent ležaja**



TOP SELLER

*CEJN® je registrirana marka od Cejn AB, Skövde, Švedska.



29



Ostale informacije

- odgovara za brzo utiskivanje i istiskivanje upravljačkih pinskih zglobova
- jedinica za prešanje može se okrenuti za 360°
- može se zaokrenuti, okrenuti i podesiti po visini za teško pristupačne dijelove
- s pneumatskom hidrauličnom nožnom crpkom s brzim izbačajem, hidrauličnim cilindrom, najčešće korištenim čahurama i potisnim komadima
- velika ušteda troškova i vremena

Tehnički podaci:

Kapacitet:	75 t
Izbačaj:	160,0 mm
Radni tlak maks.:	700 bar
Zapremina:	1,8 l

4600,00

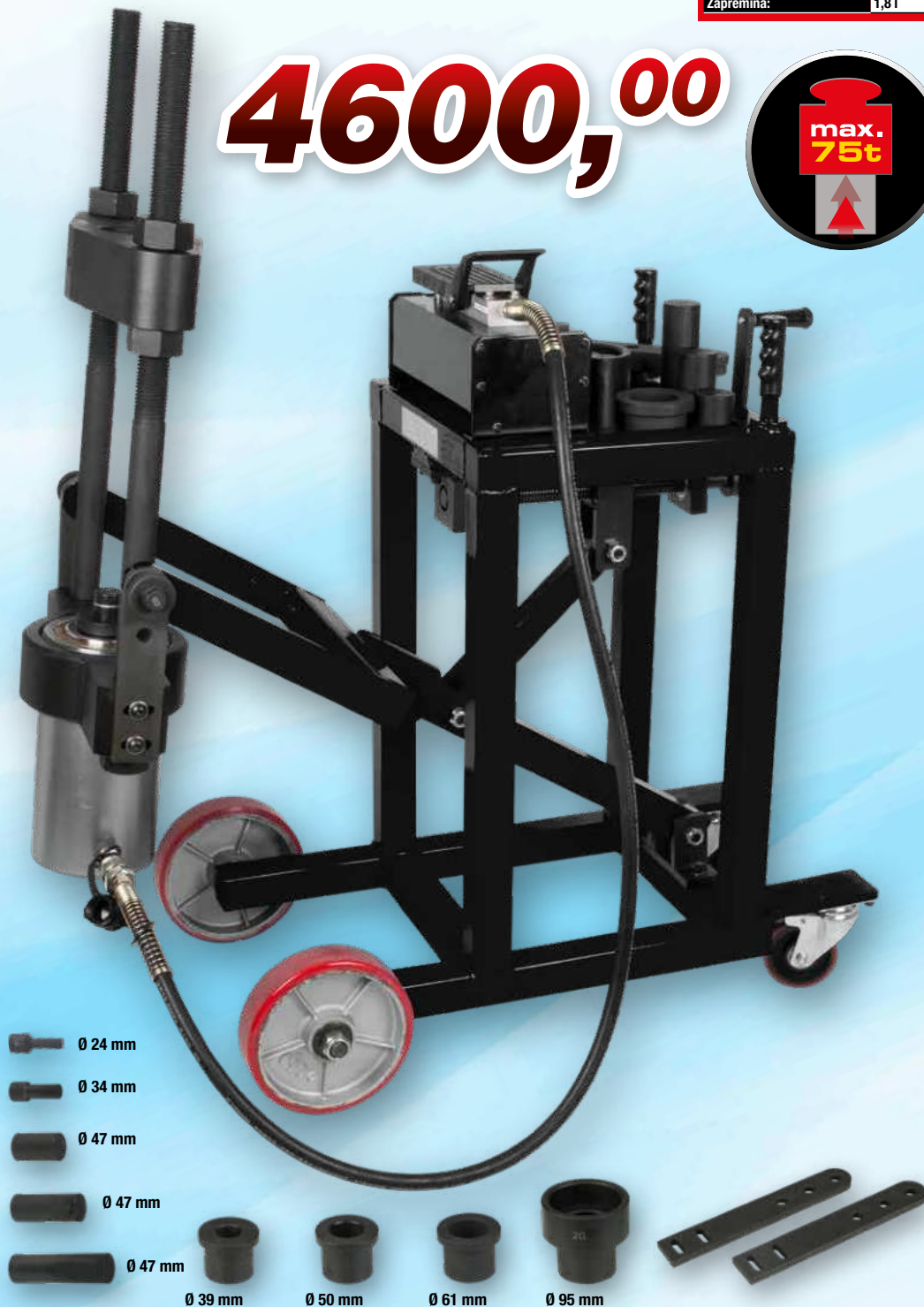

Ø 24 mm

Ø 34 mm

Ø 47 mm

Ø 47 mm

Ø 47 mm

Ø 39 mm

Ø 50 mm

Ø 61 mm

Ø 95 mm

460.3620

preša za upravljačke pinske zglobove, 75t, sa setom čahura



i **1**
Ostale informacije

NEW

i
Područja primjene:
DAF LF45 prednja osovina

DAF

75 mm

Ø 76 mm

Ø 88 mm

115,00

3/4"

460.3740 Ključ za matice s prorezom s 4 čepa za DAF

i **1**
Ostale informacije

MAN - MERCEDES

185 mm

Ø 49 mm

Ø 80 mm

Ø 95 mm

258,00

3/4"

450.0160 Ključ za matice s prorezom s 6 čepova za MAN i Mercedes

i **1**
Ostale informacije

MAN

Ø 101 mm

Ø 110 mm

80 mm

198,00

3/4"

450.0170 Ključ za matice s prorezom s 6 čepova za MAN

i **1**
Ostale informacije

MAN TGA

339,00

Ø 67 mm

Ø 133 mm

Ø 148 mm

160 mm

3/4"

450.0175 MAN TGA ključ za matice s prorezom s vodičom

i **1**
Ostale informacije

SAF

85 mm

Ø 118 mm

36 mm

82 mm

185,00

1"

450.0201 Ključ za matice osovine za SAF

i **1**
Ostale informacije

SCANIA

80 mm

Ø 98 mm

75 mm

140,00

1"

450.0221 Ključ za matice osovine za Scaniu



i **27**
Ostale informacije

SAUER - BPW
SCANIA - FUSO - HINO



1145,00



- 2 x M18x1,5
- 2 x M20x1,5
- 2 x M22x1,5
- 2 x M24x1,5
- 2 x M30x1,5
- 2 x 7/8"x11G



460.1765 Univerzalan skidač glavine kotača-set za kamione

i **1**
Ostale informacije

metrički: 1,0 - 1,25 - 1,5 - 1,75 - 2,0 - 2,5 - 3,0 - 3,5 mm
col: 24 - 20 - 18 - 16 - 14 - 12 - 11,5 - 11 - 10 - 9 - 8 - 7,5 - 7 - 6 - 5 - 4 brzine/cola

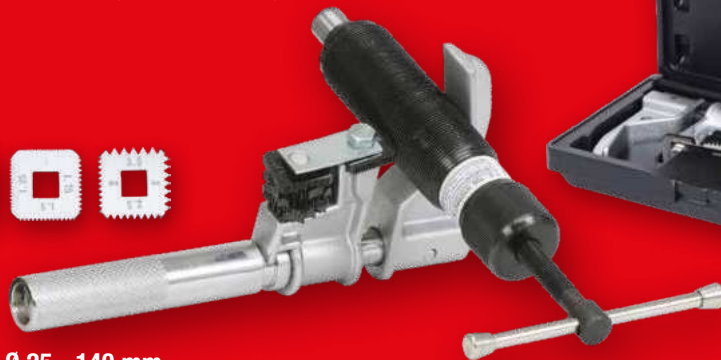

**TOP
SELLER**

195,00

150.1430 Češalj za vanjske navoje Ø 25 - 140 mm

i **9**
Ostale informacije



i **9**
Ostale informacije



- 1/2"
- 3/4"



- 1/2"
- 3/4"

Područja primjene:
montaža i demontaža valjkastih ležajeva,
zupčanika, kupastih ležajeva, kugličnih ležajeva itd.
poljoprivredna tehnika, šumarska i komunalna
tehnika, građevinski strojevi, industrija,
komercijalna vozila itd.

9 x

9 x

1/2": KM4-KM5-KM6-KM7-KM8
3/4": KM9-KM10-KM11-KM12

1/2": KM4-KM5-KM6-KM7-KM8
3/4": KM9-KM10-KM11-KM12

364,00

453,00

450.5000 Utični ključ-set za KM-matice s prorezom, armatura vani

450.5020 Utični ključ-set za KM-matice s prorezom, armatura unutra



performance

NAŠA ŠIROKA PONUDA AUTODIZALICA NA STRANICAMA 95 DO 103.



Ostale informacije



Ostale informacije

NEW

599,00

460.5500 Set za montažu i demontažu vijaka za kotače



Ostale informacije



NEW

410,00

460.1300 Set alata za kočnice za BPW

Za ležajeve kotača: 33213 i 33118



Ostale informacije



MERCEDES ACTROS, ATEGO

36 mm 20,5 mm 17,5 mm 7 mm



905,00

Prikladno za brtve vratila stražnje osovine Mercedes ACTROS i ATEGO (uključujući ACTROS s AP osovinama od 11,5 t; 13 t i 16 t)

460.5580 Set alata za montažu brtvenog prstena za Mercedes



i **7** **VOLVO** **NEW**

Ostale informacije

Ø 156 mm Ø 148 mm Ø 124 mm

Ø 147 mm Ø 134 mm Ø 127 mm

310,00

Za brtvene prstenove:
3985463, 098*Ø125*8L, 800792A, 800792C, Ø125*Ø148*9.7L

Za ležajeve kotača:
F-566426, H195, F-566425, H195, F-800792.28.

460.4050 Set alata za montažu brtvenog prstena za Volvo

i **36** Područja primjene: Knorr (SB, SN i SK), Wabco (PAN 19-1 i PAN 22-1), Haldex Modul T (SAF, SBS2220 H0)

Ostale informacije

1096,00

460.4720 Set za popravku tijela kočnice

i **5** **SAF** **TOP SELLER**

Ostale informacije

12 mm

41,00

171 mm

12 mm

8 mm 8 mm

10 mm M9

460.2615 Set specijalnih utičnih ključeva za koćione klipove za WABCO i Knorr disk kočnice

i **1** Ostale informacije

150 mm

45 mm

Ø 18 mm

189,00

450.0340 Razvrtač za ABS-senzore teretnih vozila **TOP SELLER**

i **1** Udarni Torx E ključ s 2 udarne površine

Ostale informacije

L mm

B mm

od 50,00

3/4"

		B mm	L mm	
517.0908	E18	30	215	50,00 €
517.0910	E20	32	220	54,00 €
517.0914	E24	38	220	54,00 €

i **1** Ostale informacije

140 mm

41,00

T60

3/4"

450.0441 Teretni bit-nasadni ključ za Torx vijke, dug



Ostale informacije

ROBUSNA KVALITETA U SVOM NAJBOLJEM IZDANJU!

TOP SELLER



2590,00



KRATKO VRIJEME PRIPREMANJA



460.0605 Zračno hidraulički uređaj za zakivanje



VOLVO, RENAULT

NEW



Alat za otpuštanje patrone za sušač zraka za Volvo / Renault

460.0501



NEW



Alat za otpuštanje za uklanjanje izlaznog crijeva zračnog kompresora

460.5666



79,00

i **Ostale informacije**

1/2"
Ø 0-170 mm

Lančani ključ za patrone filtra za ulje i patrone sušača zraka

460.5216

i **Ostale informacije**

1:64 **3.800 mm**

128,00

300 mm

27 mm **30 mm** **32 mm** **33 mm** **1"**

516.1180 Univerzalni pojačivač snage-set

TOP SELLER

i **Ostale informacije**

26,00

250 mm **28 - 60 mm**

150.1995 Kliješta za šesir kapice

i **Ostale informacije**

45,00

24 mm **32 mm** **27 mm** **630 mm**

3/4"

518.1155 Križasti ključ za kotače komercijalnih vozila

Šesterokutni teretni nasadni ključ-set, ekstra dug

od 39,00

EKSTRA DUGO

3/4"

		L	D1	D2	T		
	mm	mm	mm	mm	mm		
515.1184		32,0	270,0	49,0	44,0	32,0	39,00 €
515.1193		32,0	400,0	49,0	44,0	32,0	45,00 €
515.1194		33,0	400,0	50,0	44,0	32,0	50,00 €

D1 **T** **D2** **L**

i **Ostale informacije**

59,00

30 x 178 mm **70 g** **9 mm**

150.1080 Vulkanizerski set za komercijalna vozila

1 **2** **3** **4** **5** **6** **7**

NEOBAVEZAN

19,00

150.1082

TOP SELLER

POSTANITE MILIJUNAŠ!

FRAZA KOJOJ VJERUJE PREKO MILIJUN KUPACA!



Vaš partner



KS Tools Werkzeuge und Maschinen GmbH

Seligenstädter Grund 10 - 12
63150 Heusenstamm

NJEMAČKA

Mail: customerservice@kstools.com
Web: www.kstools.com

Objavljanjem ovog prospekta sve prethodno objavljene cijene prestaju vrijediti. Prodaja samo specijaliziranim prodavaonicama. Zadržano pravo na tiskarske pogreške, propuste i tehničke izmjene. Sve cijene u EUR, bez PDV-a, vrijede do 30.9.2025.

917.0779

samo
98,00

SET NASADNIH KLJUČEVA, 179-DIJELNI